

GE
Grid Solutions

MultiNet Serial to Ethernet Converter

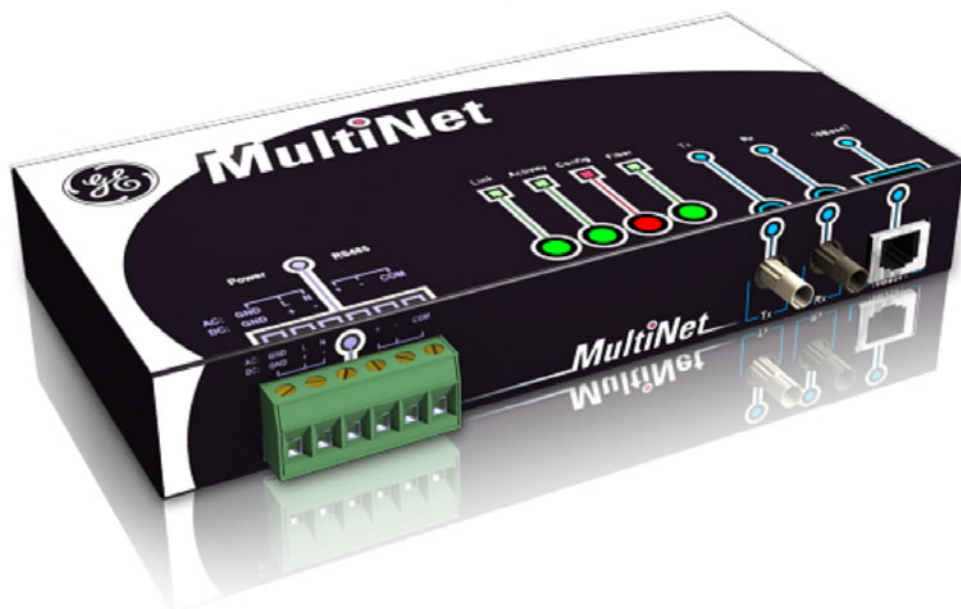

Instruction Manual

Firmware Revision 1.x

Manual P/N: 1601-0117-A5

GE Publication Number: GEK-106498D



Copyright © 2019 GE Multilin. All rights reserved.

The contents of this manual are the property of GE Multilin. This documentation is furnished on license and may not be reproduced in whole or in part without the permission of GE Multilin. The content of this manual is for informational use only and is subject to change without notice.

Part number: 1601-0117-A5 (October 2019)

For product support, contact the information and call center as follows:

GE Grid Solutions
650 Markland Street
Markham, Ontario
Canada L6C 0M1

Worldwide telephone: +1 905 927 7070
Europe/Middle East/Africa telephone: +34 94 485 88 54
North America toll-free: 1 800 547 8629
Fax: +1 905 927 5098

Worldwide e-mail: multilin.tech@ge.com
Europe e-mail: multilin.tech.euro@ge.com
Website: <http://www.gegridsolutions.com/multilin>

Table of Contents

FEATURES	1
DESCRIPTION	2
RS485 SERIAL PORT	3
10BASE-F FIBER OPTIC PORT	4
INPUT POWER TERMINALS	4
MOUNTING	5
GETTING STARTED WITH ENERVISTA MULTINET SETUP SOFTWARE	6
CONFIGURATION	8
EXAMPLE: CONNECTING MULTINET TO A PQM	10
EXAMPLE: CONFIGURING A LAPTOP TO COMMUNICATE TO MULTINET OVER CROSSOVER CABLE.	13
DIMENSIONS	15
ORDER CODE	16
SPECIFICATIONS	17
WARRANTY	19
REVISION HISTORY	19

TABLE OF CONTENTS

MultiNet

Serial to Ethernet Converter

Instruction Manual

1. Features

- Converts Modbus[®] RTU over RS485 into Modbus[®] TCP/IP over Ethernet.
- Supports both 10BaseT Ethernet and 10BaseF fiber connections.
- Connect up to 32 RS485 serial devices to an Ethernet network.
- Modbus[®] TCP/IP allows multiple SCADA masters to simultaneously connect and communicate to the same IED.
- The Multinet-FE is specifically designed for use with the PQMII and other GE serial Modbus IEDs and deployed for use in an Electrical utility or Substation as part of a Large Scale Fixed Installation (LSFI).
- Simple "plug and play" device setup with EnerVista Multinet Setup software.

2. Description

The MultiNet Serial-to-Ethernet converter is a communications module that provides GE Multilin serial Modbus IEDs with Modbus TCP/IP communications over Ethernet. MultiNet has the capability to connect up to 32 serial Modbus devices, eliminating complex wiring and additional communications converters, as well as providing a streamlined and economical Ethernet hub. Unlike most communications converters designed for commercial use, MultiNet is environmentally hardened to withstand severe utility and industrial conditions.

MultiNet can be used to connect an existing Modbus RTU network over RS485 onto a LAN in order to support multiple SCADA masters or advanced HMI systems. Additionally, the use of MultiNet greatly facilitates the setup and wiring of any serial device to a communications center since it avoids costly RS485 cable runs. Finally, large RS485 networks are slow and have a typical limit of 32 devices. MultiNet allows customers to expand that limit as well as improving network performance by separating large RS485 networks into smaller groups.

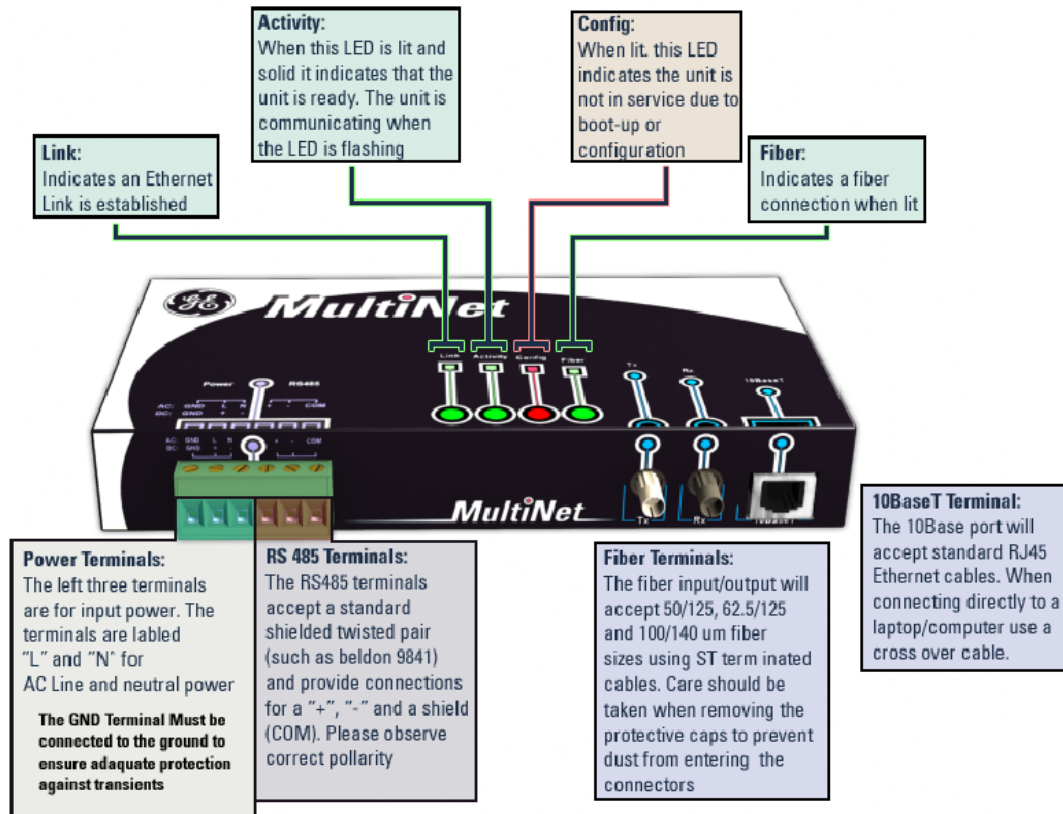

Figure -1: Connections

3. RS485 Serial Port

RS485 data transmission and reception is accomplished over a single twisted pair with transmit and receive data alternating over the same two wires. Using this port, continuous monitoring and control to a PLC, protection relay or any serial Modbus IED is possible.

Connect the "+", "-" and common terminal of MultiNet to the "+", "-" and common terminals of all the IEDs. Correct polarity must also be observed. For instance, the IEDs must be connected with all RS485 "+" terminals connected together, and all RS485 "-" terminals connected together.

To minimize errors from noise, the use of shielded twisted pair wire is recommended. The COM terminal should be connected to the common wire inside the shield, when provided. To avoid loop currents, the shield should be grounded at one point only. Each relay should also be daisy-chained to the next relay in the link. A maximum of 32 relays can be connected in this manner without exceeding driver capability.

Lightning strikes and ground surge currents can cause large momentary voltage differences between remote ends of the communication link. For this reason, surge protection devices are internally provided at the communication port. An isolated power supply with an opto-coupled data interface also acts to reduce noise coupling. To ensure maximum reliability, all equipment should have similar transient protection devices installed.

Both ends of the RS485 circuit can be terminated with impedance as shown in *Figure 2: Typical Configuration*. **Termination networks should only be applied if long cable runs are used between RS485 connections.** A typical load value for a terminating network is a 120-ohm resistor in series with a 100-pF capacitor.



NOTE

The termination capacitors are used for AC termination to reduce the power consumption of the idle link, as well as to reduce the ringing voltage. The negative effect is a reduction in cable length and bit rate. Termination capacitor values are dependent on various factors, including the number of Unit Loads, network data rate, and cable length. The termination capacitor value provided in the instruction manual should be taken as a guideline only. In order to determine the optimum capacitor value factors, such as number of devices connected on the network, network speed, physical media, and network cable length should be considered.

4. 10BASE-F Fiber Optic Port

The fiber optic communications port allows for fast and efficient communications with Modbus TCP/IP at 10 Mbps. Fiber optic transmissions provide an ideal solution for areas where RS485 communications or Ethernet via a twisted pair have traditionally caused problems. Fiber is immune to electrical interference and provides complete isolation.

Optical fibers may be connected to the MultiNet supporting a wavelength of 820 nm in multimode. Optical fiber is only available with the MultiNet-FE option (see the Order Code for details). The MultiNet-FE has a 10BaseF transmitter/receiver for optical fiber communications and supports optical fiber sizes of 50/125 μm , 62.5/125 μm , and 100/140 μm . The fiber optic port is designed such that the response times will not vary for any core 100 μm or less in diameter. For optical power budgeting, splices are required every 1 km for the transmitter/receiver pair (the ST type connector contributes for a connector loss of 0.2 dB). When splicing optical fibers, the diameter and numerical aperture of each fiber must be the same. Only a quarter turn of the coupling is required to engage or disengage the ST type connector.

The 10BaseT Ethernet port and the 10BaseF Fiber port are internally linked and should not be used together.



Ensure the dust covers are installed when the fiber is not in use. Dirty or scratched connectors can lead to high losses on a fiber link.



Observing any fiber transmitter output may cause injury to the eye!

5. Input Power Terminals

The input power terminals are located on the left side of the green terminal block. MultiNet may be connected to either 90 to 265 V AC at 50/60 Hz or 90 to 300 V DC supply power. The terminals are labeled "+" and "-" for DC positive and negative input power and "L" and "N" are for AC line and neutral input power. The GND terminal must be connected to ground to ensure adequate protection against transients.



Control power supplied to the MultiNet must be connected to the matching power supply range. If the voltage is applied to the wrong terminals, damage may occur!

6. Mounting

MultiNet is DIN rail mountable and ships with two DIN rail clips attached on the rear of the unit. The DIN rail clips can attach the unit onto a standard 35 mm DIN rail. Place the top hooks of the clip against the DIN rail and apply a downward force until an audible click is heard. In order to remove the unit, place a standard slotted screwdriver between the unit and the DIN rail and apply an upward force.

Each clip is held onto the unit using a standard 4-40 Phillips head screw. If the DIN rail option is not used, remove the DIN rail clips by unscrewing the six screws. Once the clips have been removed re-screw the six screws back into their original positions. Do not substitute screws, since the wrong length of screw may damage the internals of the product and void the warranty.

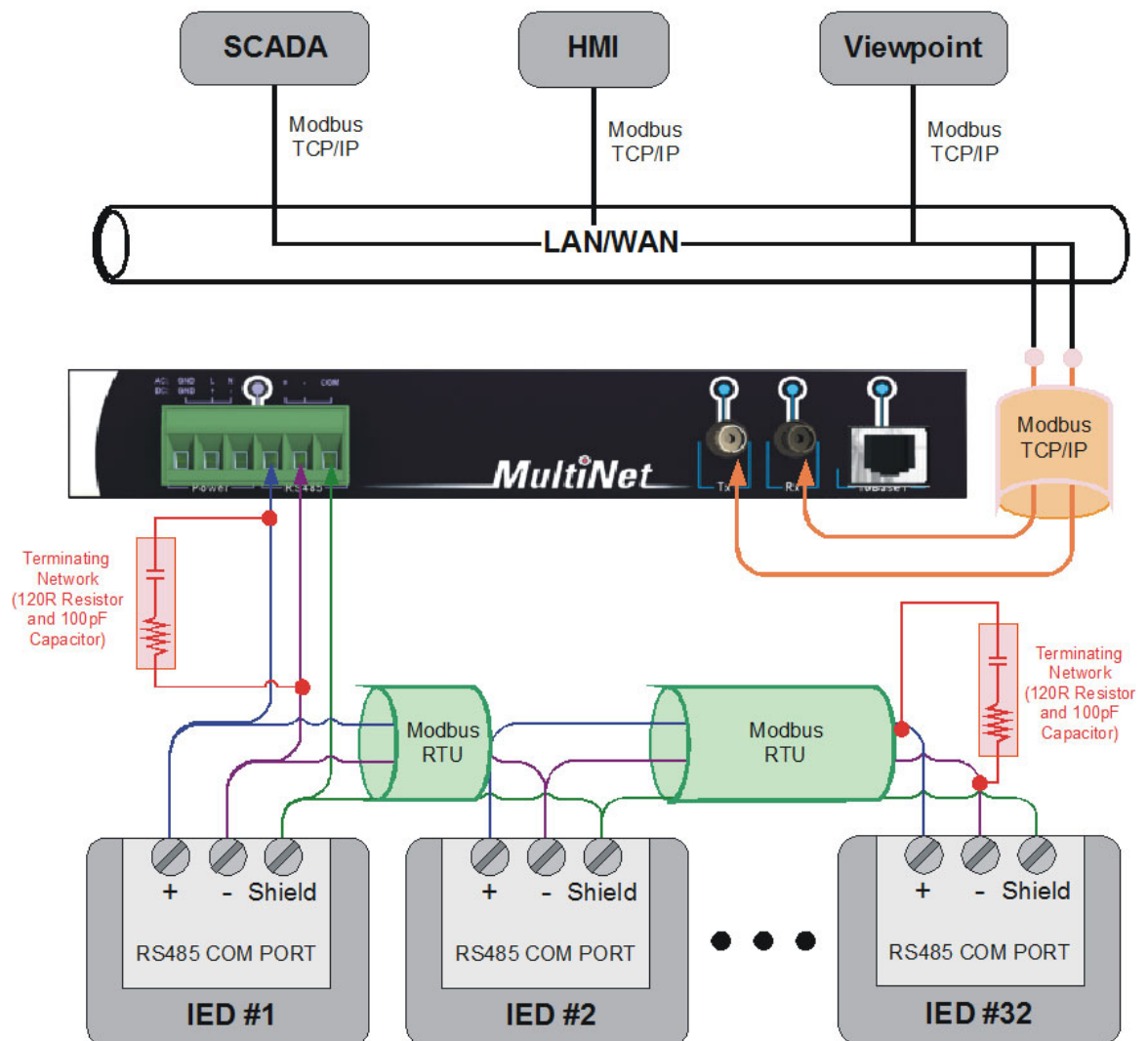

Figure -2: Typical Configurations

7. Getting Started with EnerVista Multinet Setup Software

The EnerVista Multinet Setup software is provided to edit settings and configure the unit. The setup software connects to the unit through either the 10BaseT (RJ45*) port or the 10BaseF (fiber) port.



* Use a shielded RJ45 cable

The following requirements must be met to ensure correct operation of the EnerVista Multinet Setup software:

- Pentium class or higher processor (Pentium II 300 MHz or higher recommended)
- Windows 95, 98, 98SE, ME, NT 4.0 (Service Pack 4 or higher), 2000, XP
- 64 MB of RAM (256 MB recommended)
- 40 MB of available hard drive space (100 MB recommended)
- Video capable of displaying 800 × 600 or higher in High Color mode (16-bit color)
- An Ethernet communications port.

To download EnerVista Multinet Setup directly, go to gegridsolutions.com/multilin/catalog/multinet.htm

To download EnerVista Multinet Setup through EnerVista Launchpad (suggested), follow the procedure outlined below.

1. Direct your web browser to the EnerVista Launchpad website at <http://www.gegridsolutions.com/multilin/enervista/launchpad/>. Under **Resources** click **Software** and download the newest version of EnerVista LaunchPad.
2. Run the EnerVista LaunchPad installation program and follow the on-screen instructions.

3. Setup the EnerVista MultiNet Setup Software:
 - i On the main EnerVista LaunchPad page, select "IED SetUp" from the LaunchPad window.
 - ii Click on the "Install Software" button at the top of the screen.
 - iii Select **MultiNet** from the product list. Indicate you are installing the software from the Web, then click "Check Now".
 - iv Check off the **MultiNet** Setup program from the Downloads screen and click "Download Now".
 - v Once the download is complete, the **MutiNet** installation file will be shown on screen. Double-click this file to run the installation program.
 - vi Run the installation program and follow the on-screen instructions.
 - vii Once the installation is complete, click on "IED Setup" on the left panel of the screen. You will see a Multinet icon on the IED screen. Double click on it to launch the EnerVista Multinet Setup application.

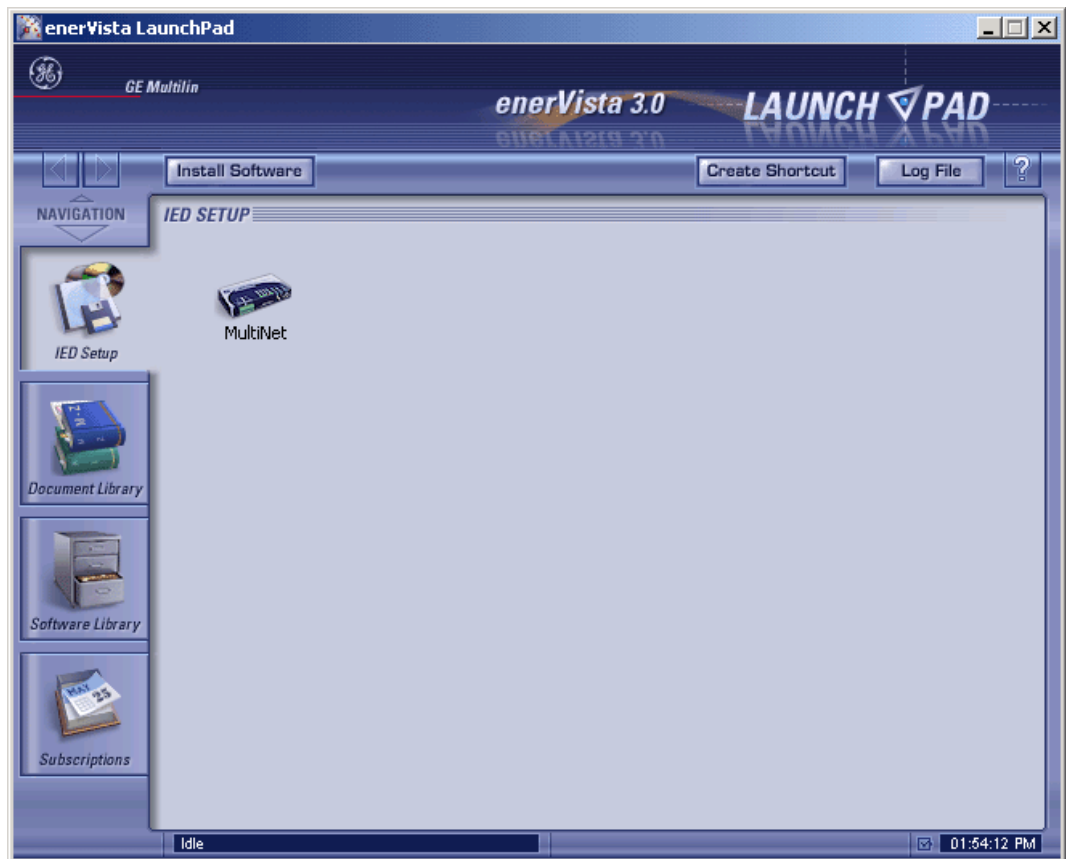

8. Configuration

Before starting, verify that the Ethernet network cable is properly connected to the Ethernet port on MultiNet. To connect MultiNet directly to the Ethernet port of a PC or laptop, use a crossover cable; to connect MultiNet directly to an Ethernet network, use a regular pass-through RJ-45 cable.



The EnerVista Multinet Setup software is used for several different Multinet models. Note that only the **Communications > Multinet Setup** menu option described here applies to the basic Multinet converter.

To setup MultiNet for Ethernet communications use the following procedure:

1. Install and start the latest version of the EnerVista MultiNet Setup software (available online from gegridsolutions.com/multilin/catalog/multinet.htm. See the previous section: *Getting Started with EnerVista Multinet Setup Software*).



Figure -3: EnerVista MultiNet Setup Software Main Screen

2. Select the **Communications > Multinet Setup** menu item to open the Device Setup window.
3. The left pane shows the currently configured MultiNet Devices. Click the **Add Device** button to add a new MultiNet device to the device list.

4. Enter the desired name in the **Device Name** field and a description (optional) of the device.
5. The MAC address is used to identify and configure the unit. Fill in the **MAC address** field with the address found on the back of MultiNet (for example, 00-20-4A-62-AE-66).

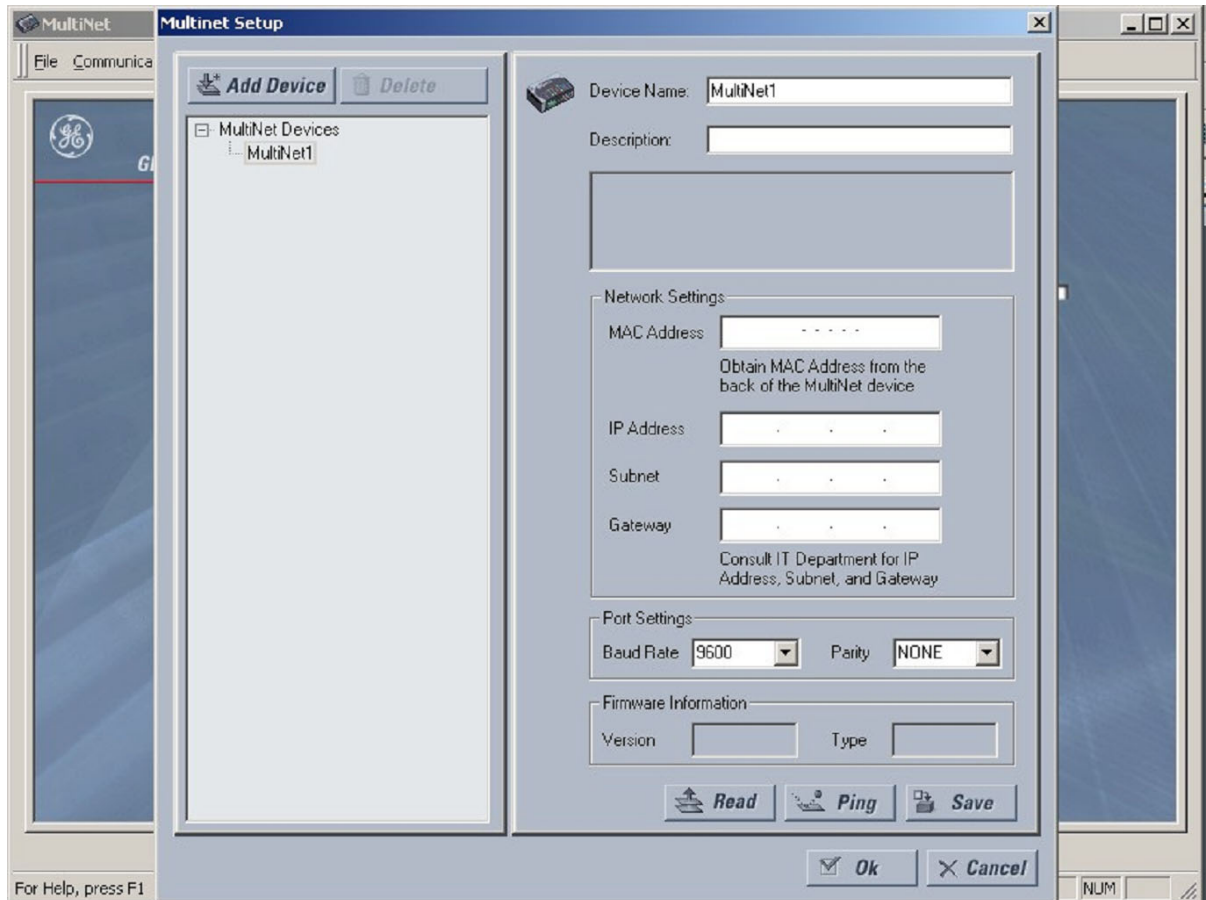

Figure -4: Multinet Setup Screen

6. Under network settings, enter the **IP address**, **Subnet** and **Gateway** of the MultiNet network interface. If these values are not known, consult your network administrator.
7. Under port settings, enter the **Baud Rate** and **Parity** bit for the MultiNet serial interface.
8. Once the serial and network settings have been entered, click [**SAVE**] to save the changes. The message "success saving settings to MultiNet device" will appear in the status window when complete. Additional devices may be added to the list by following the same procedure.
9. Click [**OK**] to close the device setup screen.

8.1 EXAMPLE: Connecting MultiNet to a PQM

The following steps detail how to use MultiNet in order to connect a PQM to an Ethernet network.

1. Wire COM1 on the back of the PQM to the RS485 terminals on MultiNet. The wiring is detailed in *Figure 2: Typical Configuration*. Since for this example short cable runs are used, terminators are not necessary.
2. Check the settings within the PQM, noting the Baud rate, Parity Bit and Slave Address. For the sake of this example the values of **19200**, **none** (or N), and **254** will be used for the baud rate, parity bit, and slave address respectively.
3. Note the MAC address of the MultiNet unit. For this example, a MAC address of **00-20-4A-62-AE-00** will be used. The MAC address is located on the rear of the unit.
4. Connect MultiNet to the network LAN. Consult your IT administrator to determine a suitable IP address, subnet, and gateway setting for the unit. For this example we will use **192.168.1.2** as the IP address, **255.255.255.0** as the Subnet and **192.168.1.1** as the Gateway.
5. Open the Enervista MultiNet Setup software. Use the procedure detailed in the *Configuration* section to configure the unit. For this example the following settings will be used:

Device Name: MultiNet 1

IP Address: 192.168.1.2

Subnet: 255.255.255.0

Gateway: 192.168.1.1

Baud Rate: 19200

Parity Bit: None

The baud rate and parity bit are identical to those set within the PQM. Additionally, the MAC address from step 3 is needed to configure the Network settings.

6. Close the Enervista MultiNet Setup software and open the EnerVista Viewpoint Monitoring software.
7. From the main screen of EnerVista Viewpoint Monitor, click **Device Setup** to open the Device Setup window.



NOTE

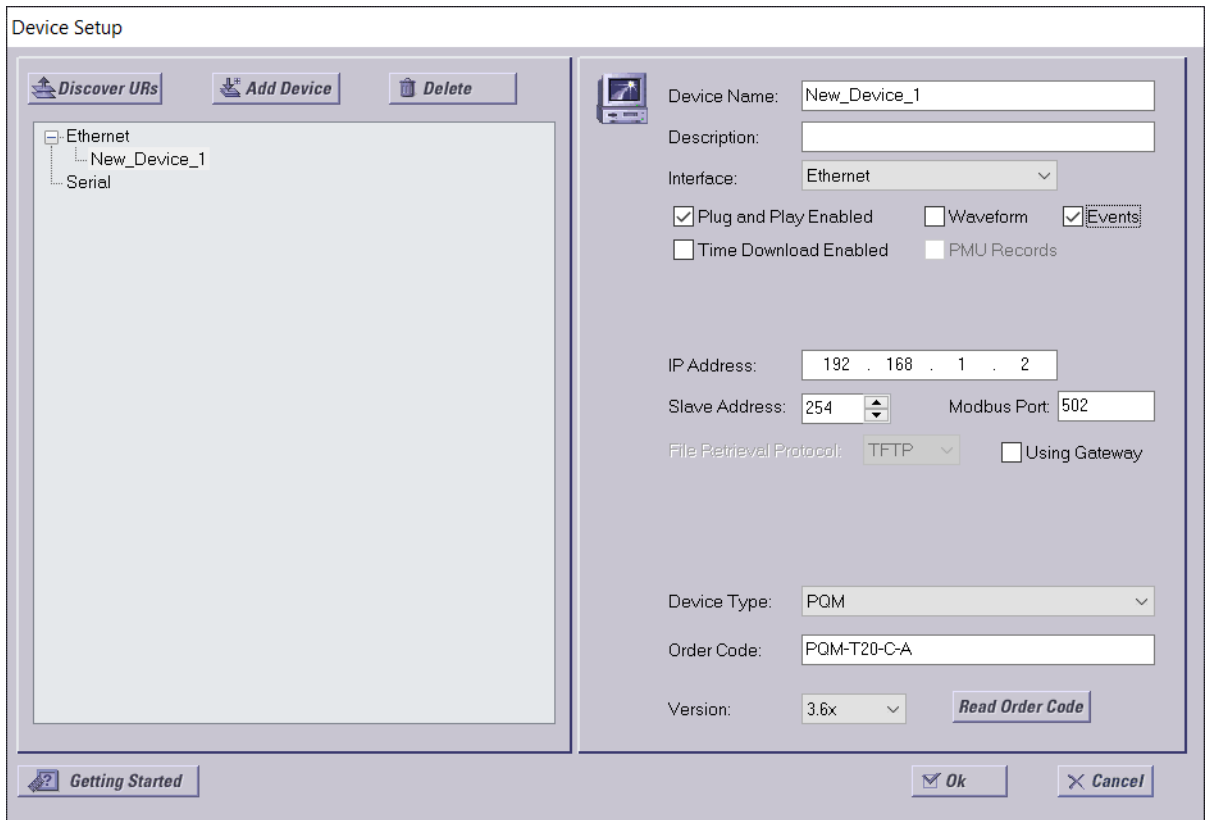

Figure -5: Device Setup Screen within Enervista Viewpoint Monitoring

8. On the left is the device list showing the “Ethernet” default site. Click on the plus sign next to the “Ethernet” site to reveal the default device. Selecting this device allows parameters to be entered in the right pane. For this example, we are going to configure the “Ethernet” device as our PQM.
9. Click **Read Order Code**. Viewpoint will locate the PQM device and connect to it. Once this order code has been read, click **OK** to save the configuration.
10. Select the **Plug & Play > Create Schema** menu item to open the Plug and Play Device dialog box. Ensure that “PQM” is selected within the drop down selection. Click **Create** to automatically create plug and play screens for the PQM.

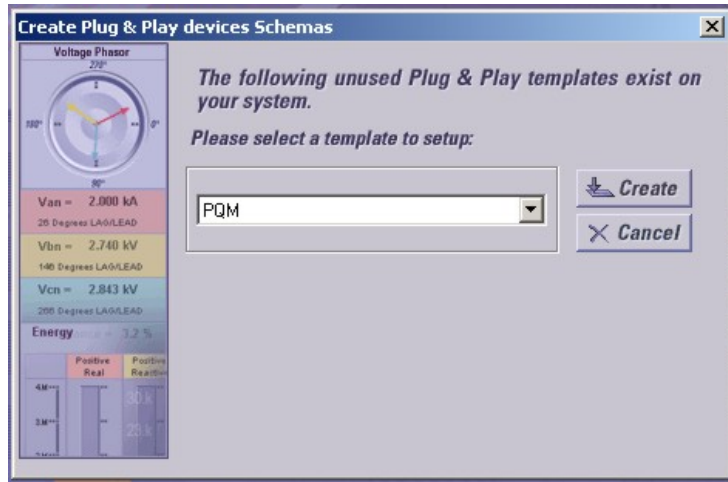

Figure -6: Dialog Box for Creating “Plug & Play” Screens

- When finished, the plug and play menu appears, showing our PQM labeled as **Quick Connect**. Click the **Dashboard** button below the PQM icon to view the device information. We have now successfully accessed our PQM through MultiNet.



Figure -7: Plug and Play Menu Showing Attached PQM.

8.2 EXAMPLE: Configuring a Laptop to Communicate to MultiNet over Crossover Cable.

This procedure details how to configure MultiNet for use with a crossover cable. Using a crossover cable allows for a direct local connection to a MultiNet device, bypassing the network. The following procedure is based upon the Windows 2000 operating system; variations of this procedure will work other windows operating systems, as they are all fairly similar.



NOTE

This example uses sample values for IP address, subnet and gateway. Please substitute these values with your own

1. Connect a CAT5 crossover Ethernet cable between the laptop running Enervista MultiNet Setup software and the MultiNet unit. Since the 10BaseT connection is being used, the 10BaseF connection must be disconnected.
2. Right click on **My Network Places** and select properties from the pop down menu.
3. Click on the **Local Area Connection** icon and select properties.
4. Select **Internet Protocol (TCP/IP)** and click **Properties**.
5. Record the current settings of the Internet Protocol (TCP/IP) properties window.
6. Select the **Use the following IP address** button. The Multinet IP address must be assigned as the gateway address of the laptop. For example, if an IP address of 192.168.1.2 has been assigned to the MultiNet, use that address as the gateway for the laptop. Similarly, set the IP address of the laptop to the gateway IP of the MultiNet. For example, set the laptop IP address to "192.168.1.1" if the gateway IP of the MultiNet is "192.168.1.1". The subnet mask is to remain the same. Fill in the corresponding fields – refer to the table below:

	Laptop	Multinet
IP Address	192.168.1.1	192.168.1.2
Gateway Address	192.168.1.2	192.168.1.1
Subnet	255.255.255.0	255.255.255.0



NOTE

The laptop has been configured as the gateway for MultiNet – do not connect the laptop back to the network without first restoring the settings for the IP address. Again, the IP address, Subnet and gateway supplied here are for this example only. Please change these values so that they correspond to the values assigned in your network.

7. Click **OK** to save the changes. Depending on your operating system, you may wish to restart your PC.

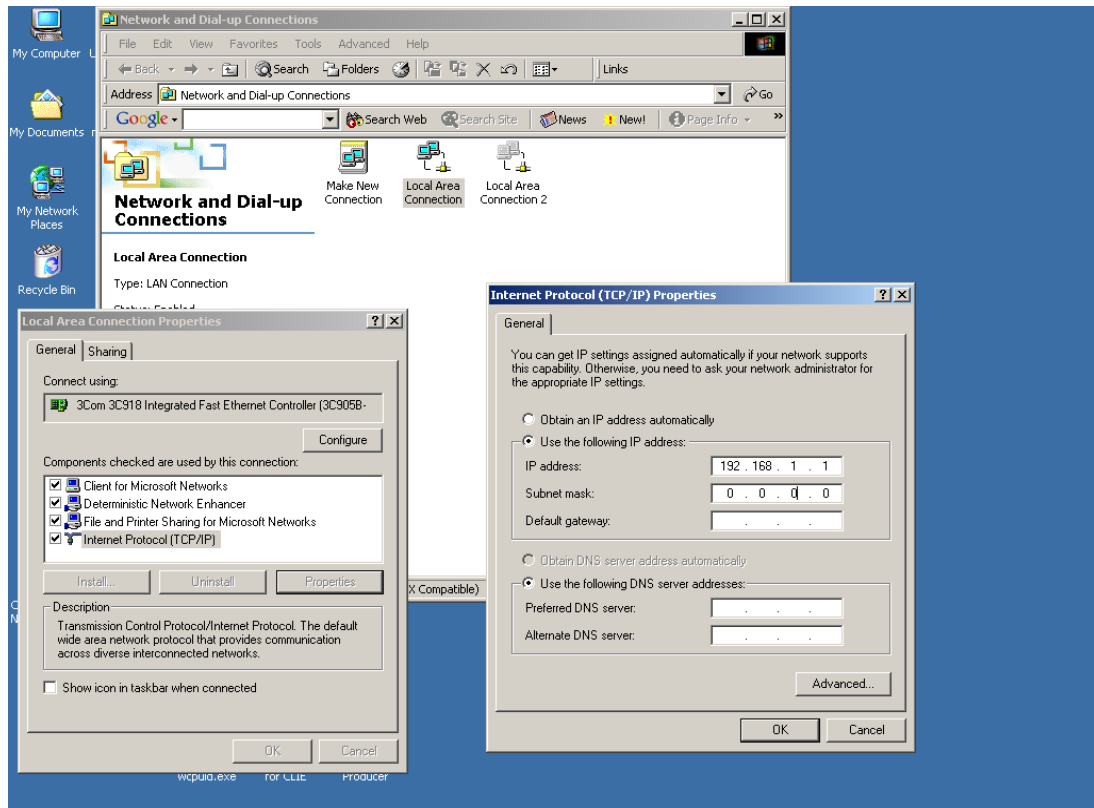
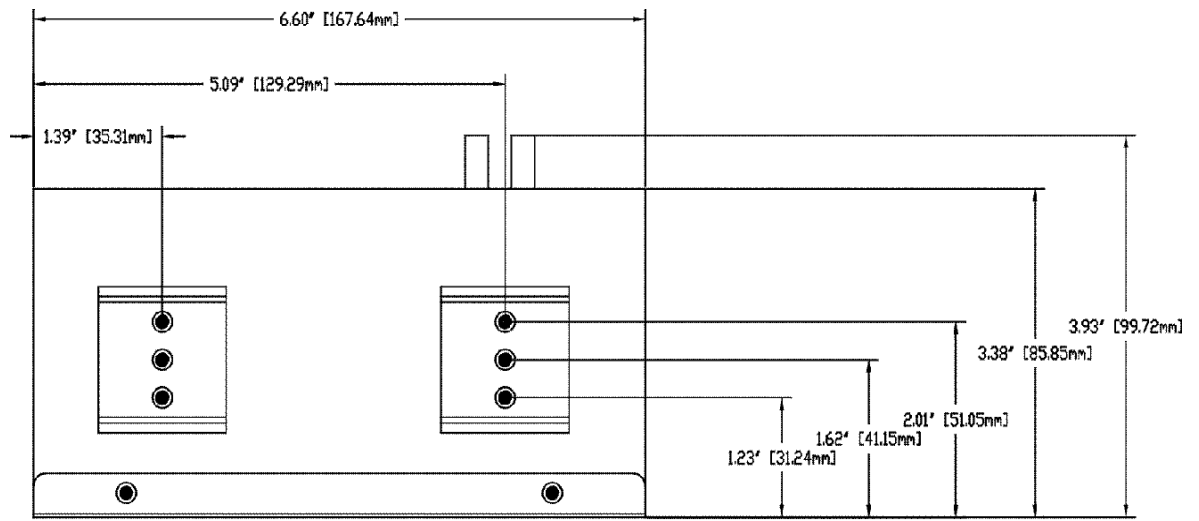

Figure -8: Setting the IP Address on a Laptop.

8. Open the Enervista MultiNet Setup program and follow the procedure detailed within the **CONFIGURATION** section. For this example use the IP address of 192.168.1.2, subnet of 255.255.255.0 and a gateway of 192.168.1.1.
9. Once the configuration of the MultiNet device is complete, return the laptop to its previous settings using the recorded values from step 5. If the MultiNet device was configured properly, communications may be tested on the connected network using EnerVista, as shown in the first example.

9. Dimensions



BOTTOM VIEW

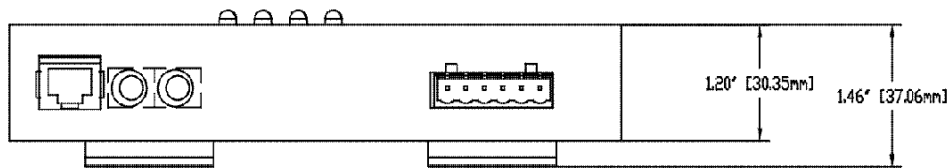

TOP VIEW

823701A1.DWG

FIGURE -1: MultiNet Dimensions

10. Order Code

Multinet	*	Modbus RTU to Modbus TCP/IP converter with RS485 communications
	FE	10BaseT Ethernet Port, and 10BaseF fiber optic port



The Multinet Serial to Ethernet Converter is sometimes called the Multinet, Multinet-FE, or Multinet E485 converter. All of these terms refer to the same product.

11. Specifications

ETHERNET

Version 2.0/IEEE 802.3

10BaseT:RJ45 connection*

10BaseF:820 nm, multi-mode, fiber optic with
ST connector

Modbus® TCP/IP

* Use a shielded RJ45 cable.



NOTE

RS485 PORT

RS485 2-wire, half duplex, isolated

Baud Rate:300 bps to 115.2 Kbps

Protocol:Modbus® RTU

INSTALLATION

Configuration through EnerVista Setup software

POWER INPUT

AC power:100 to 240 V AC ($\pm 10\%$) at 50/60 Hz,
20 VA max

Minimum/Maximum AC voltage: 90
VAC / 264 VAC

DC power:90 to 300 V DC, 5 W max.

MECHANICAL SPECIFICATIONS

Material:Metal enclosure

Dimensions:6.6" \times 3.98" \times 1.46"

Shipping box:12.9" \times 9" \times 3.25"

Ship weight:2 lbs.

TYPE TESTS

TEST	REFERENCE STANDARD	TEST LEVEL
Dielectric voltage withstand	EN60255-27	2300VAC
Impulse voltage withstand	EN60255-27	5KV
Insulation resistance	EN60255-27	500VDC >100Mohm
Electrostatic Discharge	IEC61000-4-2	Level 4
RF immunity	IEC61000-4-3	20V/m 80-1GHz
Fast Transient Disturbance	IEC61000-4-4	Class A and B
Surge Immunity	IEC61000-4-5	2KV & 1KV
Conducted RF Immunity	IEC61000-4-6	10Vrms
Radiated & Conducted Emissions	CISPR11 /CISPR22/ IEC60255-25	Class A
Power magnetic Immunity	IEC61000-4-8	Level 5
Pulsed Magnetic Immunity	IEC61000-4-9	1000A/m
Damped Oscillatory magnetic	IEC61000-4-10	100A/m
Voltage Dip & interruption	IEC61000-4-11	0,40,70,80% dips, 250/ 300 cycle interrupts
Damped Oscillatory	IEC61000-4-18/IEEE37.90.1	2.5KV / 1MHz

Ingress Protection	IEC60529	IP10 Front , IP40 remaining sides
--------------------	----------	-----------------------------------

APPROVALS

	Applicable Council Directive:	According to:
CE compliance	Low voltage directive	EN60255-27
	EMC Directive	EN61000-6-2
		EN61000-6-4
		UL508
North America	cULus e83849 - vol 1 section 10 (AC power only, DC sources pending)	C22.2.No 14
ISO	Manufactured under a ISO 9001 registered program	

ENVIRONMENTAL

Ambient temperatures	
Operating range:	-20°C to 70°C
Altitude:	2000m (max)
Insulation Class:	1
Pollution Degree:	II
Overvoltage Category:	II
Ingress protection:	IP10 Front IP40 top,bottom,back, left/right

12. Warranty

For products shipped as of 1 October 2013, GE warrants most of its GE manufactured products for 10 years. For warranty details including any limitations and disclaimers, see the Terms and Conditions at

<https://www.gegridsolutions.com/multilin/warranty.htm>

For products shipped before 1 October 2013, the standard 24-month warranty applies.

13. Revision History

Table –2: Revision History

Manual P/N	Release Date
1601-0117-A1	June 2003
1601-0117-A2	April 2009
1601-0117-A3	August 2011
1601-0117-A4	July 2017
1601-0117-A5	October 2019

For products shipped before 1 October 2013, the standard 24-month warranty applies.

Table –3: Major updates for A5

Section	Changes
cover	Manual number to A5
general	minor corrections throughout
7	Updated links and included full product names.
8	Updated configuration instructions to include correct menu path (Communications > Multinet Setup) and removed references to the product CD. Updated Figure 5 Enervista Viewpoint Monitoring screenshot.
10	Added note below order codes re. Multinet, Multinet-FE and Multinet E485 Converter all referring to the same product.
13	Added Revision History

Table –4: Major updates for A4

Section	Changes
cover	Manual number to A4 10 year warranty logo added. Contact information updated.
general	Branding to Grid Solutions and format updated. minor corrections throughout
1	Updated Feature list.
12	Updated warranty section to include 10 year warranty added.

