

# G30 Generator Protection System



## Instruction Manual

Product version: 7.7x

GE publication code: 1601-0166-AG2 (GEK-131039A)



Copyright © 2018 GE Multilin Inc. All rights reserved.

G30 Generator Protection System Instruction Manual for version 7.7x.

G30, FlexLogic, FlexElement, FlexCurve, FlexAnalog, FlexInteger, FlexState, EnerVista, CyberSentry, HardFiber, Multilin, and GE Multilin are trademarks or registered trademarks of GE Multilin Inc.

The contents of this manual are the property of GE Multilin Inc. This documentation is furnished on license and may not be reproduced in whole or in part without the permission of GE Multilin. The content of this manual is for informational use only and is subject to change without notice.

Part number: 1601-0166-AG2 (May 2018)

# G30 Generator Protection System

## Table of contents

---

<b>1</b>	<b>INTRODUCTION</b>	<b>1.1</b>	<b>Safety symbols and definitions .....</b>	<b>1-1</b>
		1.1.1	General cautions and warnings .....	1-1
		<b>1.2</b>	<b>For further assistance .....</b>	<b>1-2</b>

---

<b>2</b>	<b>PRODUCT DESCRIPTION</b>	<b>2.1</b>	<b>Product description .....</b>	<b>2-1</b>
		<b>2.2</b>	<b>Security .....</b>	<b>2-5</b>
		<b>2.3</b>	<b>Order codes .....</b>	<b>2-9</b>
		2.3.1	Order codes with enhanced CT/VT modules .....	2-9
		2.3.2	Order codes with process bus modules .....	2-12
		2.3.3	Replacement modules .....	2-15
		<b>2.4</b>	<b>Signal processing .....</b>	<b>2-18</b>
		2.4.1	UR signal processing .....	2-18
		<b>2.5</b>	<b>Specifications .....</b>	<b>2-20</b>
		2.5.1	Protection elements .....	2-20
		2.5.2	User-programmable elements .....	2-26
		2.5.3	Monitoring .....	2-28
		2.5.4	Metering .....	2-28
		2.5.5	Inputs .....	2-29
		2.5.6	Power supply .....	2-31
		2.5.7	Outputs .....	2-31
		2.5.8	Communication protocols .....	2-34
		2.5.9	Inter-relay communications .....	2-35
		2.5.10	CyberSentry security .....	2-36
		2.5.11	Graphical front panel .....	2-36
		2.5.12	Environmental .....	2-37
		2.5.13	Type tests .....	2-38
		2.5.14	Production tests .....	2-38
		2.5.15	Approvals .....	2-39
		2.5.16	Maintenance .....	2-39

---

<b>3</b>	<b>INSTALLATION</b>	<b>3.1</b>	<b>Unpack and inspect .....</b>	<b>3-1</b>
		<b>3.2</b>	<b>Panel cutouts .....</b>	<b>3-2</b>
		3.2.1	Horizontal units .....	3-2
		3.2.2	Vertical units .....	3-6

	3.2.3	Rear terminal layout.....	3-10
<b>3.3</b>		<b>Wiring .....</b>	<b>3-13</b>
	3.3.1	Typical wiring .....	3-13
	3.3.2	Dielectric strength .....	3-15
	3.3.3	Control power.....	3-16
	3.3.4	CT/VT modules .....	3-17
	3.3.5	Process bus modules .....	3-19
	3.3.6	Contact inputs and outputs.....	3-20
	3.3.7	Transducer inputs and outputs.....	3-32
	3.3.8	RS232 port.....	3-34
	3.3.9	CPU communication ports .....	3-35
	3.3.10	IRIG-B.....	3-37
<b>3.4</b>		<b>Direct input and output communications .....</b>	<b>3-38</b>
	3.4.1	Description .....	3-38
	3.4.2	Fiber: LED and ELED transmitters.....	3-40
	3.4.3	Fiber laser transmitters.....	3-40
	3.4.4	G.703 interface.....	3-41
	3.4.5	RS422 interface.....	3-45
	3.4.6	RS422 and fiber interface .....	3-47
	3.4.7	G.703 and fiber interface.....	3-48
	3.4.8	IEEE C37.94 interface .....	3-48
	3.4.9	C37.94SM interface .....	3-51
<b>3.5</b>		<b>Activate relay .....</b>	<b>3-54</b>
<b>3.6</b>		<b>Install software .....</b>	<b>3-55</b>
	3.6.1	EnerVista communication overview .....	3-55
	3.6.2	System requirements.....	3-56
	3.6.3	Install software.....	3-56
<b>3.7</b>		<b>Add device to software.....</b>	<b>3-57</b>
	3.7.1	Set IP address in UR.....	3-58
	3.7.2	Configure serial connection.....	3-64
	3.7.3	Configure Ethernet connection .....	3-65
	3.7.4	Configure modem connection.....	3-66
	3.7.5	Automatic discovery of UR devices.....	3-67
<b>3.8</b>		<b>Connect to the G30.....</b>	<b>3-68</b>
	3.8.1	Connect to the G30 in EnerVista .....	3-68
	3.8.2	Use Quick Connect via front RS232 port.....	3-69
	3.8.3	Use Quick Connect via front USB port .....	3-70
	3.8.4	Use Quick Connect via a rear Ethernet port.....	3-70
<b>3.9</b>		<b>Set up CyberSentry and change default password.....</b>	<b>3-71</b>
<b>3.10</b>		<b>Import settings .....</b>	<b>3-72</b>
<b>3.11</b>		<b>Connect to D400 gateway.....</b>	<b>3-73</b>
	3.11.1	Oscillography files.....	3-73
	3.11.2	Event records.....	3-73
	3.11.3	Log files.....	3-73
	3.11.4	Setting files.....	3-74
<hr/>			
<b>4</b>		<b>INTERFACES</b>	
	<b>4.1</b>	<b>EnerVista software interface.....</b>	<b>4-1</b>
	4.1.1	Introduction .....	4-1
	4.1.2	Settings files .....	4-1
	4.1.3	Event viewing.....	4-2
	4.1.4	File support .....	4-3
	4.1.5	EnerVista main window .....	4-3
	4.1.6	Protection summary window .....	4-4
	4.1.7	Settings templates.....	4-5
	4.1.8	Secure and lock FlexLogic equations .....	4-9



4.1.9	Settings file traceability .....	4-12
<b>4.2</b>	<b>Front panel interface .....</b>	<b>4-15</b>
4.2.1	Front panel .....	4-15
4.2.2	Front panel display .....	4-17
4.2.3	Front panel navigation keys .....	4-37
4.2.4	LED indicators .....	4-38
4.2.5	Front panel labelling .....	4-43
4.2.6	Menu navigation .....	4-49
4.2.7	Change settings .....	4-51
4.2.8	View actual values .....	4-56
4.2.9	Breaker control .....	4-57
4.2.10	Change passwords .....	4-58
4.2.11	Invalid password entry .....	4-59
<b>4.3</b>	<b>Logic diagrams .....</b>	<b>4-60</b>
<b>4.4</b>	<b>FlexLogic design using Engineer .....</b>	<b>4-61</b>
4.4.1	Design logic .....	4-63
4.4.2	Send file to and from device .....	4-73
4.4.3	Monitor logic .....	4-74
4.4.4	View front panel and print labels .....	4-75
4.4.5	Generate connectivity report .....	4-76
4.4.6	Preferences .....	4-76
4.4.7	Toolbars .....	4-80

---

## 5 SETTINGS

<b>5.1</b>	<b>Settings menu .....</b>	<b>5-1</b>
<b>5.2</b>	<b>Overview .....</b>	<b>5-4</b>
5.2.1	Introduction to elements .....	5-4
5.2.2	Introduction to AC sources .....	5-6
<b>5.3</b>	<b>Product setup .....</b>	<b>5-7</b>
5.3.1	Security .....	5-7
5.3.2	Display properties .....	5-26
5.3.3	Graphical front panel .....	5-28
5.3.4	Clear relay records .....	5-40
5.3.5	Communications .....	5-41
5.3.6	Modbus user map .....	5-109
5.3.7	Real time clock .....	5-110
5.3.8	User-programmable fault report .....	5-115
5.3.9	Oscillography .....	5-116
5.3.10	Data logger .....	5-118
5.3.11	User-programmable LEDs .....	5-120
5.3.12	User-programmable self-tests .....	5-124
5.3.13	Control pushbuttons .....	5-125
5.3.14	User-programmable pushbuttons .....	5-126
5.3.15	Flex state parameters .....	5-132
5.3.16	User-definable displays .....	5-133
5.3.17	Direct inputs and outputs .....	5-135
5.3.18	Teleprotection .....	5-141
5.3.19	Installation .....	5-142
<b>5.4</b>	<b>Remote resources .....</b>	<b>5-143</b>
5.4.1	Remote resources configuration .....	5-143
<b>5.5</b>	<b>System setup .....</b>	<b>5-144</b>
5.5.1	AC inputs .....	5-144
5.5.2	Power system .....	5-145
5.5.3	Signal sources .....	5-146
5.5.4	Transformer .....	5-149
5.5.5	Breakers .....	5-160

5.5.6	Disconnect switch control .....	5-165
5.5.7	FlexCurves .....	5-170
<b>5.6</b>	<b>FlexLogic.....</b>	<b>5-177</b>
5.6.1	FlexLogic operands .....	5-177
5.6.2	FlexLogic rules .....	5-190
5.6.3	FlexLogic evaluation.....	5-190
5.6.4	FlexLogic example.....	5-191
5.6.5	FlexLogic equation editor.....	5-196
5.6.6	FlexLogic timers.....	5-196
5.6.7	FlexElements .....	5-196
5.6.8	Non-volatile latches.....	5-200
<b>5.7</b>	<b>Grouped elements .....</b>	<b>5-202</b>
5.7.1	Overview .....	5-202
5.7.2	Setting group 1.....	5-202
5.7.3	Transformer.....	5-203
5.7.4	Phase current .....	5-210
5.7.5	Neutral current.....	5-222
5.7.6	Ground current .....	5-230
5.7.7	Negative sequence current.....	5-237
5.7.8	Generator unbalance (ANSI 46).....	5-241
5.7.9	Split phase protection (ANSI 50SP).....	5-243
5.7.10	Voltage elements .....	5-247
5.7.11	Loss of excitation (ANSI 40) .....	5-259
5.7.12	Accidental energization (ANSI 50/27) .....	5-261
5.7.13	Sensitive directional power (ANSI 32) .....	5-263
5.7.14	Stator ground.....	5-266
<b>5.8</b>	<b>Control elements .....</b>	<b>5-268</b>
5.8.1	Overview .....	5-268
5.8.2	Trip bus .....	5-268
5.8.3	Setting groups .....	5-270
5.8.4	Selector switch .....	5-272
5.8.5	Underfrequency (ANSI 81U).....	5-278
5.8.6	Overfrequency (ANSI 81O) .....	5-279
5.8.7	Frequency rate of change (ANSI 81R).....	5-280
5.8.8	Frequency out-of-band accumulation .....	5-282
5.8.9	Synchrocheck (ANSI 25) .....	5-283
5.8.10	Digital elements.....	5-289
5.8.11	Digital counters.....	5-292
5.8.12	Monitoring elements .....	5-294
<b>5.9</b>	<b>Inputs/outputs .....</b>	<b>5-303</b>
5.9.1	Contact inputs .....	5-303
5.9.2	Virtual inputs .....	5-305
5.9.3	Contact outputs.....	5-306
5.9.4	Virtual outputs.....	5-310
5.9.5	Resetting .....	5-310
5.9.6	Direct inputs and outputs .....	5-311
5.9.7	Teleprotection.....	5-315
<b>5.10</b>	<b>Transducer inputs/outputs.....</b>	<b>5-317</b>
5.10.1	DCmA inputs.....	5-317
5.10.2	RTD inputs .....	5-318
5.10.3	DCmA outputs .....	5-319
<b>5.11</b>	<b>Testing .....</b>	<b>5-323</b>
5.11.1	Test mode function .....	5-323
5.11.2	Test mode forcing.....	5-323
5.11.3	Force contact inputs .....	5-324
5.11.4	Force contact outputs .....	5-324

	<b>5.12 Simulation .....</b>	<b>5-325</b>
	5.12.1 GOOSE.....	5-325
<b>6 ACTUAL VALUES</b>		
	<b>6.1 Actual Values menu .....</b>	<b>6-1</b>
	<b>6.2 Front panel .....</b>	<b>6-3</b>
	6.2.1 Enhanced and basic front panels.....	6-3
	6.2.2 Graphical front panel.....	6-4
	<b>6.3 Status .....</b>	<b>6-5</b>
	6.3.1 Contact inputs .....	6-5
	6.3.2 Virtual inputs.....	6-5
	6.3.3 RxGOOSE boolean inputs.....	6-5
	6.3.4 RxGOOSE DPS inputs .....	6-5
	6.3.5 Teleprotection inputs.....	6-6
	6.3.6 Contact outputs .....	6-6
	6.3.7 Virtual outputs .....	6-6
	6.3.8 RxGOOSE status.....	6-7
	6.3.9 RxGOOSE statistics .....	6-7
	6.3.10 Digital counters.....	6-7
	6.3.11 Selector switches.....	6-8
	6.3.12 Flex States.....	6-8
	6.3.13 Ethernet .....	6-8
	6.3.14 Real time clock synchronizing.....	6-8
	6.3.15 Direct inputs.....	6-9
	6.3.16 Direct devices status .....	6-10
	6.3.17 EGD protocol status .....	6-10
	6.3.18 Teleprotection channel tests .....	6-11
	6.3.19 Remaining connection status.....	6-11
	6.3.20 Parallel Redundancy Protocol (PRP).....	6-12
	6.3.21 TxGOOSE status .....	6-12
	6.3.22 Protocol.....	6-13
	<b>6.4 Metering.....</b>	<b>6-13</b>
	6.4.1 Metering conventions.....	6-13
	6.4.2 Transformer .....	6-17
	6.4.3 Sources.....	6-18
	6.4.4 Synchrocheck.....	6-23
	6.4.5 Tracking frequency.....	6-23
	6.4.6 Frequency rate of change.....	6-24
	6.4.7 Frequency out-of-band accumulation.....	6-24
	6.4.8 FlexElements.....	6-24
	6.4.9 RxGOOSE analogs .....	6-25
	6.4.10 Sensitive directional power .....	6-25
	6.4.11 Stator ground.....	6-25
	6.4.12 Volts per hertz.....	6-26
	6.4.13 Restricted ground fault.....	6-26
	6.4.14 Transducer inputs and outputs .....	6-26
	<b>6.5 Records .....</b>	<b>6-26</b>
	6.5.1 User-programmable fault reports.....	6-26
	6.5.2 Event records .....	6-27
	6.5.3 Oscillography.....	6-28
	6.5.4 Data logger .....	6-29
	6.5.5 Breaker maintenance.....	6-29
	<b>6.6 Product information .....</b>	<b>6-30</b>
	6.6.1 Model information.....	6-30
	6.6.2 Firmware revisions .....	6-31

<b>7</b>	<b>COMMANDS AND TARGETS</b>	<b>7.1</b>	<b>Commands menu</b> ..... <b>7-1</b>
		7.1.1	Virtual inputs ..... 7-2
		7.1.2	Clear records ..... 7-2
		7.1.3	Set date and time ..... 7-3
		7.1.4	Relay maintenance ..... 7-3
		7.1.5	Security ..... 7-4
		<b>7.2</b>	<b>Targets menu</b> ..... <b>7-5</b>
		7.2.1	Target messages ..... 7-5
		7.2.2	Relay self-tests ..... 7-6
<b>8</b>	<b>APPLICATION OF SETTINGS</b>	<b>8.1</b>	<b>Overview</b> ..... <b>8-1</b>
		8.1.1	Introduction ..... 8-1
		8.1.2	In-zone transformer with VT on the high-voltage side ..... 8-1
		8.1.3	In-zone transformer with VT on the low-voltage side ..... 8-3
		8.1.4	No in-zone transformer ..... 8-4
		<b>8.2</b>	<b>Settings</b> ..... <b>8-6</b>
		8.2.1	System setup ..... 8-6
		8.2.2	Power system ..... 8-7
		8.2.3	Signal sources ..... 8-7
		8.2.4	Generator unbalance ..... 8-8
		8.2.5	Loss of excitation ..... 8-9
		8.2.6	Reverse power ..... 8-10
		8.2.7	System backup overcurrent ..... 8-10
		8.2.8	Overexcitation ..... 8-12
		8.2.9	Inputs/outputs ..... 8-13
		8.2.10	Frequency ..... 8-14
		8.2.11	Accidental energization ..... 8-15
		8.2.12	FlexLogic ..... 8-15
<b>9</b>	<b>COMMISSIONING</b>	<b>9.1</b>	<b>Testing</b> ..... <b>9-1</b>
		9.1.1	Testing underfrequency and overfrequency elements ..... 9-1
<b>10</b>	<b>THEORY OF OPERATION</b>	<b>10.1</b>	<b>Directional principle</b> ..... <b>10-1</b>
		10.1.1	Current directional protection ..... 10-1
		<b>10.2</b>	<b>Saturation detector</b> ..... <b>10-2</b>
		10.2.1	CT saturation detection ..... 10-2
<b>11</b>	<b>MAINTENANCE</b>	<b>11.1</b>	<b>Monitoring</b> ..... <b>11-1</b>
		11.1.1	Devices with Site Targets ..... 11-1
		11.1.2	Data with Modbus Analyzer ..... 11-1
		<b>11.2</b>	<b>General maintenance</b> ..... <b>11-3</b>
		11.2.1	In-service maintenance ..... 11-3
		11.2.2	Out-of-service maintenance ..... 11-3
		11.2.3	Unscheduled maintenance (system interruption) ..... 11-3
		<b>11.3</b>	<b>Retrieve files</b> ..... <b>11-3</b>
		11.3.1	CyberSentry security event files ..... 11-4
		<b>11.4</b>	<b>Convert device settings</b> ..... <b>11-5</b>
		<b>11.5</b>	<b>Copy settings to other device</b> ..... <b>11-7</b>
		<b>11.6</b>	<b>Copy settings to other device</b> ..... <b>11-7</b>
		<b>11.7</b>	<b>Compare settings</b> ..... <b>11-7</b>
		11.7.1	Compare against defaults ..... 11-8

TABLE OF CONTENTS

11.7.2	Compare two devices.....	11-8
<b>11.8</b>	<b>Back up and restore settings .....</b>	<b>11-9</b>
11.8.1	Back up settings.....	11-9
11.8.2	Restore settings .....	11-11
<b>11.9</b>	<b>Upgrade software .....</b>	<b>11-13</b>
<b>11.10</b>	<b>Upgrade firmware.....</b>	<b>11-14</b>
<b>11.11</b>	<b>Replace front panel .....</b>	<b>11-16</b>
<b>11.12</b>	<b>Replace module .....</b>	<b>11-24</b>
<b>11.13</b>	<b>Battery .....</b>	<b>11-26</b>
11.13.1	Replace battery.....	11-26
11.13.2	Dispose of battery.....	11-27
<b>11.14</b>	<b>Clear files and data after uninstall .....</b>	<b>11-30</b>
<b>11.15</b>	<b>Repairs .....</b>	<b>11-31</b>
<b>11.16</b>	<b>Storage.....</b>	<b>11-31</b>
<b>11.17</b>	<b>Disposal .....</b>	<b>11-32</b>

---

<b>A</b>	<b>FLEXANALOG OPERANDS</b>	<b>A.1</b>	<b>FlexAnalog items .....</b>	<b>A-1</b>
----------	----------------------------	------------	-------------------------------	------------

---

<b>B</b>	<b>RADIUS SERVER CONFIGURATION</b>	<b>B.1</b>	<b>RADIUS server configuration .....</b>	<b>B-1</b>
----------	------------------------------------	------------	--	------------

---

<b>C</b>	<b>COMMAND LINE INTERFACE</b>	<b>C.1</b>	<b>Command line interface .....</b>	<b>C-1</b>
----------	-------------------------------	------------	-------------------------------------	------------

---

<b>D</b>	<b>MISCELLANEOUS</b>	<b>D.1</b>	<b>Warranty .....</b>	<b>D-1</b>
		<b>D.2</b>	<b>Revision history .....</b>	<b>D-1</b>

---

ABBREVIATIONS

---

INDEX



# G30 Generator Protection System

## Chapter 1: Introduction

This chapter outlines safety and technical support information.

---

### 1.1 Safety symbols and definitions

Before attempting to install or use the device, review all safety indicators in this document to help prevent injury, equipment damage, or downtime.

The following safety and equipment symbols are used in this document.



Indicates a hazardous situation which, if not avoided, will result in death or serious injury.



Indicates a hazardous situation which, if not avoided, could result in death or serious injury.



Indicates a hazardous situation which, if not avoided, could result in minor or moderate injury.



Indicates practices not related to personal injury.

#### 1.1.1 General cautions and warnings

The following general safety precautions and warnings apply.



Ensure that all connections to the product are correct so as to avoid accidental risk of shock and/or fire, for example such as can arise from high voltage connected to low voltage terminals.

Follow the requirements of this manual, including adequate wiring size and type, terminal torque settings, voltage, current magnitudes applied, and adequate isolation/clearance in external wiring from high to low voltage circuits.

Use the device only for its intended purpose and application.

Ensure that all ground paths are uncompromised for safety purposes during device operation and service.

Ensure that the control power applied to the device, the alternating current (AC), and voltage input match the ratings specified on the relay nameplate. Do not apply current or voltage in excess of the specified limits.

## 1

Only qualified personnel are to operate the device. Such personnel must be thoroughly familiar with all safety cautions and warnings in this manual and with applicable country, regional, utility, and plant safety regulations. Hazardous voltages can exist in the power supply and at the device connection to current transformers, voltage transformers, control, and test circuit terminals. Make sure all sources of such voltages are isolated prior to attempting work on the device.

Hazardous voltages can exist when opening the secondary circuits of live current transformers. Make sure that current transformer secondary circuits are shorted out before making or removing any connection to the current transformer (CT) input terminals of the device.

For tests with secondary test equipment, ensure that no other sources of voltages or currents are connected to such equipment and that trip and close commands to the circuit breakers or other switching apparatus are isolated, unless this is required by the test procedure and is specified by appropriate utility/plant procedure.

When the device is used to control primary equipment, such as circuit breakers, isolators, and other switching apparatus, all control circuits from the device to the primary equipment must be isolated while personnel are working on or around this primary equipment to prevent any inadvertent command from this device.

Use an external disconnect to isolate the mains voltage supply.

Personal safety can be affected if the product is physically modified by the end user. Modifications to the product outside of recommended wiring configuration, hardware, or programming boundaries is not recommended end-use practice. Product disassembly and repairs are not permitted. All service needs to be conducted by the factory.



LED transmitters are classified as IEC 60825-1 Accessible Emission Limit (AEL) Class 1M. Class 1M devices are considered safe to the unaided eye. Do not view directly with optical instruments.

**NOTICE**

This product is rated to Class A emissions levels and is to be used in Utility, Substation Industrial environments. Not to be used near electronic devices rated for Class B levels.

## 1.2 For further assistance

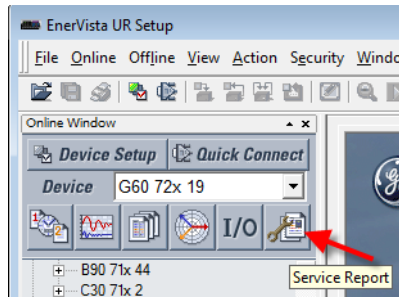
For product support, contact the information and call center as follows:

GE Grid Solutions  
650 Markland Street  
Markham, Ontario  
Canada L6C 0M1  
Worldwide telephone: +1 905 927 7070  
Europe/Middle East/Africa telephone: +34 94 485 88 54  
North America toll-free: 1 800 547 8629  
Fax: +1 905 927 5098  
Worldwide e-mail: [multilin.tech@ge.com](mailto:multilin.tech@ge.com)  
Europe e-mail: [multilin.tech.euro@ge.com](mailto:multilin.tech.euro@ge.com)  
Website: <http://www.gegridsolutions.com/multilin>

When contacting GE by e-mail, optionally include a device information file, which is generated in the EnerVista software by clicking the **Service Report** button. The service report also can be generated in the field, for example with a USB cable connected between the graphical front panel and a computer, and the Device Setup configured for the USB connection.



Figure 1-1: Generate service report in EnerVista software





# G30 Generator Protection System

## Chapter 2: Product description

This chapter outlines the product, order codes, and specifications.

---

### 2.1 Product description

The G30 Generator Protection System is part of the Universal Relay (UR) series of products. It is a microprocessor-based relay that provides protection, monitoring, control, and recording functions for AC generators driven by steam, gas, or hydraulic turbine. Current, voltage, and frequency protection are provided along with fault diagnostics.

Voltage, current, and power metering are built in as standard features. Current parameters are available as total waveform root mean square (RMS) magnitude, or as fundamental frequency only RMS magnitude and angle (phasor).

Diagnostic features include an event recorder that stores 1024 time-tagged events, oscillography capable of storing up to 64 records with programmable trigger, content and sampling rate, and data logger acquisition of up to 16 channels, with programmable content and sampling rate. The internal clock used for time-tagging can be synchronized with an IRIG-B signal, using the Simple Network Time Protocol (SNTP) over the Ethernet port, or using the Precision Time Protocol (PTP). This precise time stamping allows the sequence of events to be determined throughout the system. Events can also be programmed (via FlexLogic™ equations) to trigger oscillography data capture that can be set to record the measured parameters before and after the event for viewing on a computer. These tools significantly reduce troubleshooting time and simplify report generation in the event of a system fault.

Several options are available for communication. An RS232 port (USB port with the graphical front panel) can be used to connect to a computer to program settings and monitor actual values. The rear RS485 port allows independent access by operating and engineering staff. It can be connected to system computers with baud rates up to 115.2 kbps. All serial ports use the Modbus RTU protocol. The IEC 60870-5-103 protocol is supported on the RS485 interface. IEC 60870-5-103, DNP, and Modbus cannot be enabled simultaneously on this interface. Also only one of the DNP, IEC 60870-5-103, and IEC 60870-5-104 protocols can be enabled at any time on the relay. When the IEC 60870-5-103 protocol is chosen, the RS485 port has a fixed even parity and the baud rate can be either 9.6 kbps or 19.2 kbps. The 100Base-FX or 100Base-TX Ethernet interface provides fast, reliable communications in noisy environments. The Ethernet port supports IEC 61850, Modbus/TCP, TFTP, and PTP (according to IEEE Std. 1588-2008 or IEC 61588), and it allows access to the relay via any standard web browser (G30 web pages). The IEC 60870-5-104 protocol is supported on the Ethernet port. The Ethernet port also supports the Parallel Redundancy Protocol (PRP) of IEC 62439-3 (clause 4, 2012) when purchased as an option.

Secure Routable GOOSE (R-GOOSE) is supported with software options.

Settings and actual values can be accessed from the front panel or EnerVista software.

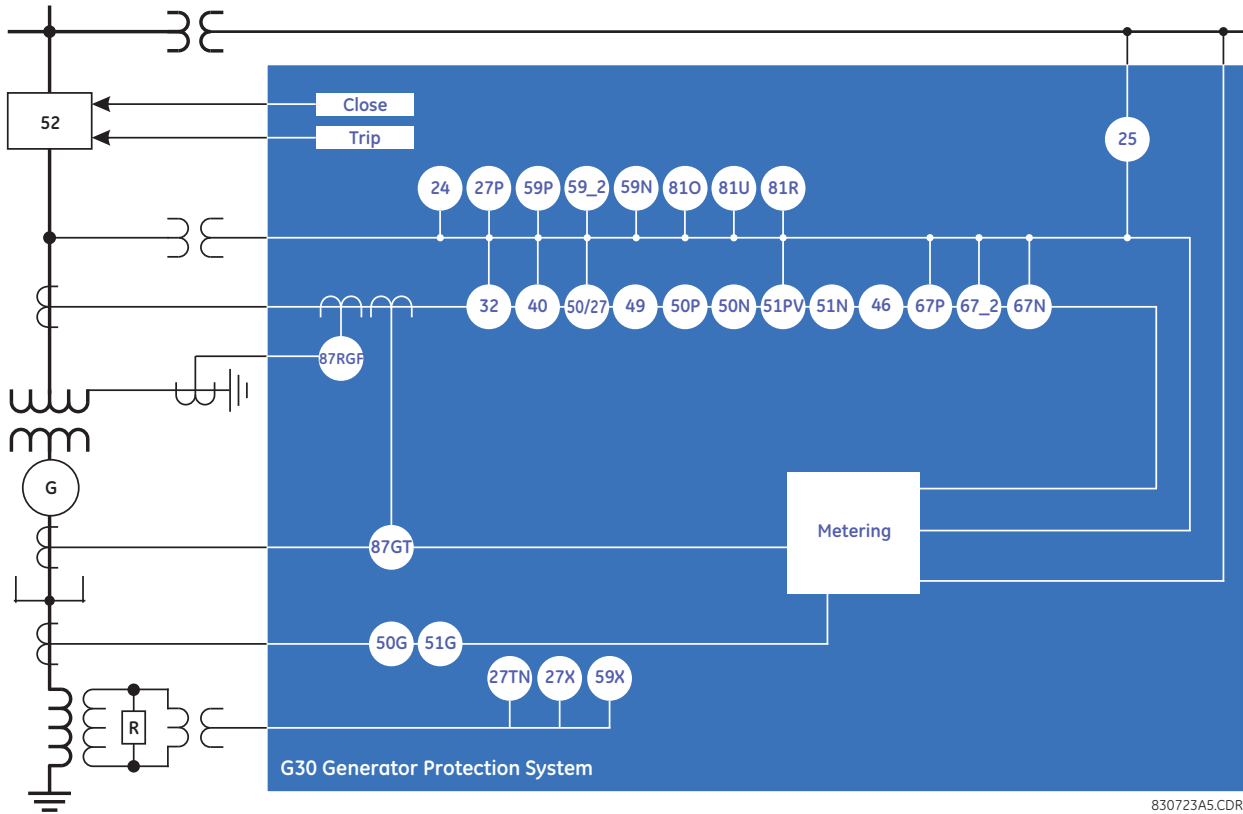
The G30 uses flash memory technology that allows field upgrading as new features are added. Firmware and software are upgradable.

The following single-line diagrams illustrate the relay functionality using American National Standards Institute (ANSI) device numbers.

**Table 2-1: ANSI device numbers and functions supported**

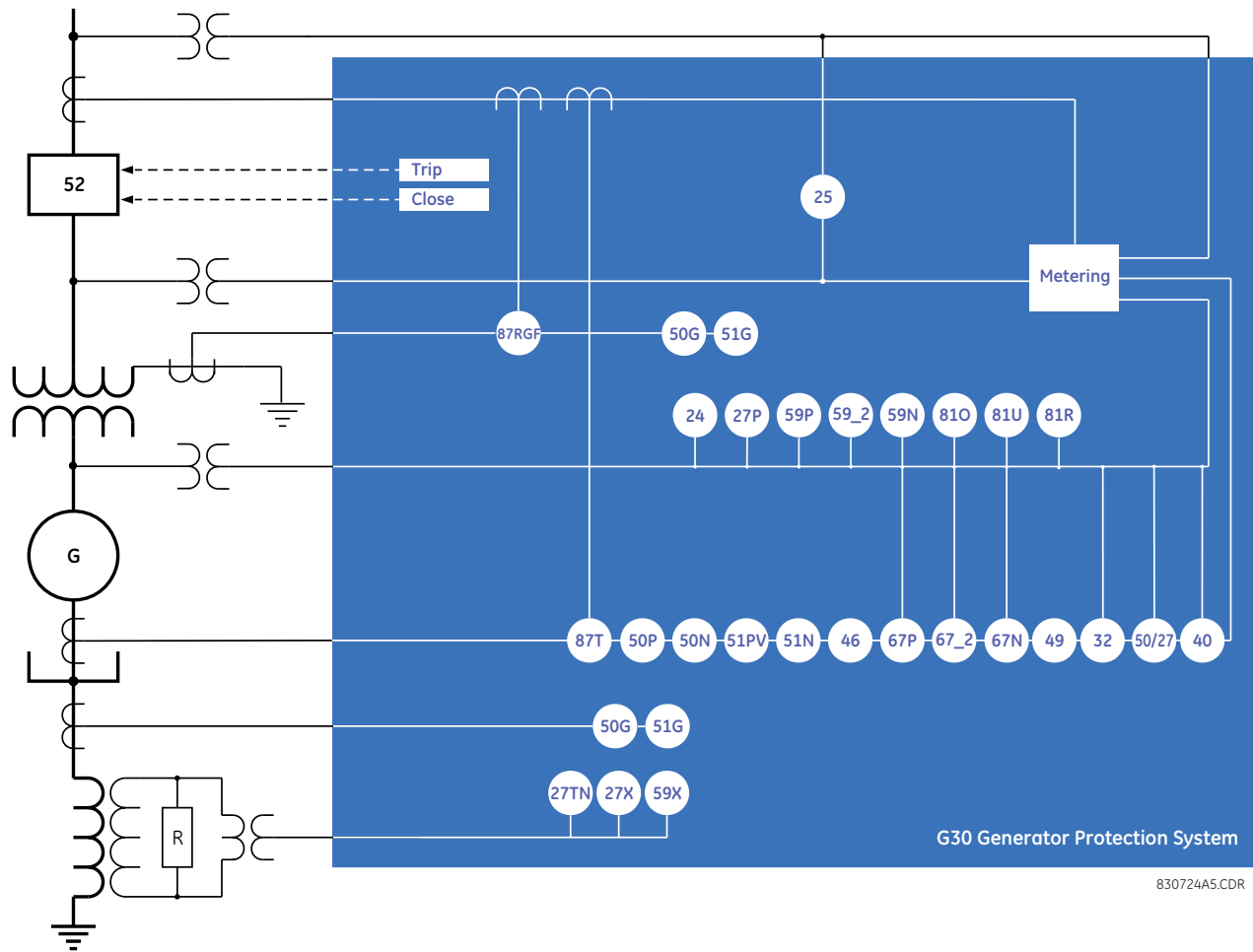
Device number	Function	Device number	Function
24	Volts per hertz	51N	Neutral time overcurrent
25	Synchrocheck	51PV	Phase time overcurrent with voltage restraint
27P	Phase undervoltage	59N	Neutral overvoltage
27TN	Third harmonic neutral undervoltage	59P	Phase overvoltage
27X	Auxiliary undervoltage	59X	Auxiliary overvoltage
32	Sensitive directional power	59_2	Negative-sequence overvoltage
40	Loss of excitation	67_2	Negative-sequence directional overcurrent
46	Generator unbalance	67N	Neutral directional overcurrent
49	Thermal overload protection	67P	Phase directional overcurrent
50G	Ground instantaneous overcurrent	81O	Overfrequency
50N	Neutral instantaneous overcurrent	81R	Rate of change of frequency
50P	Phase instantaneous overcurrent	81U	Underfrequency
50SP	Split phase protection	87RGF	Restricted ground fault
50/27	Accidental energization	87GT	Generator/transformer differential
51G	Ground time overcurrent		

**Figure 2-1: Single-line diagram PTS on transformer HV side**



830723A5.CDR

Figure 2-2: Single-line diagram PTS on transformer LV side (protection assigned to generator neutral CTS)



2

Figure 2-3: Single-line diagram, no transformer

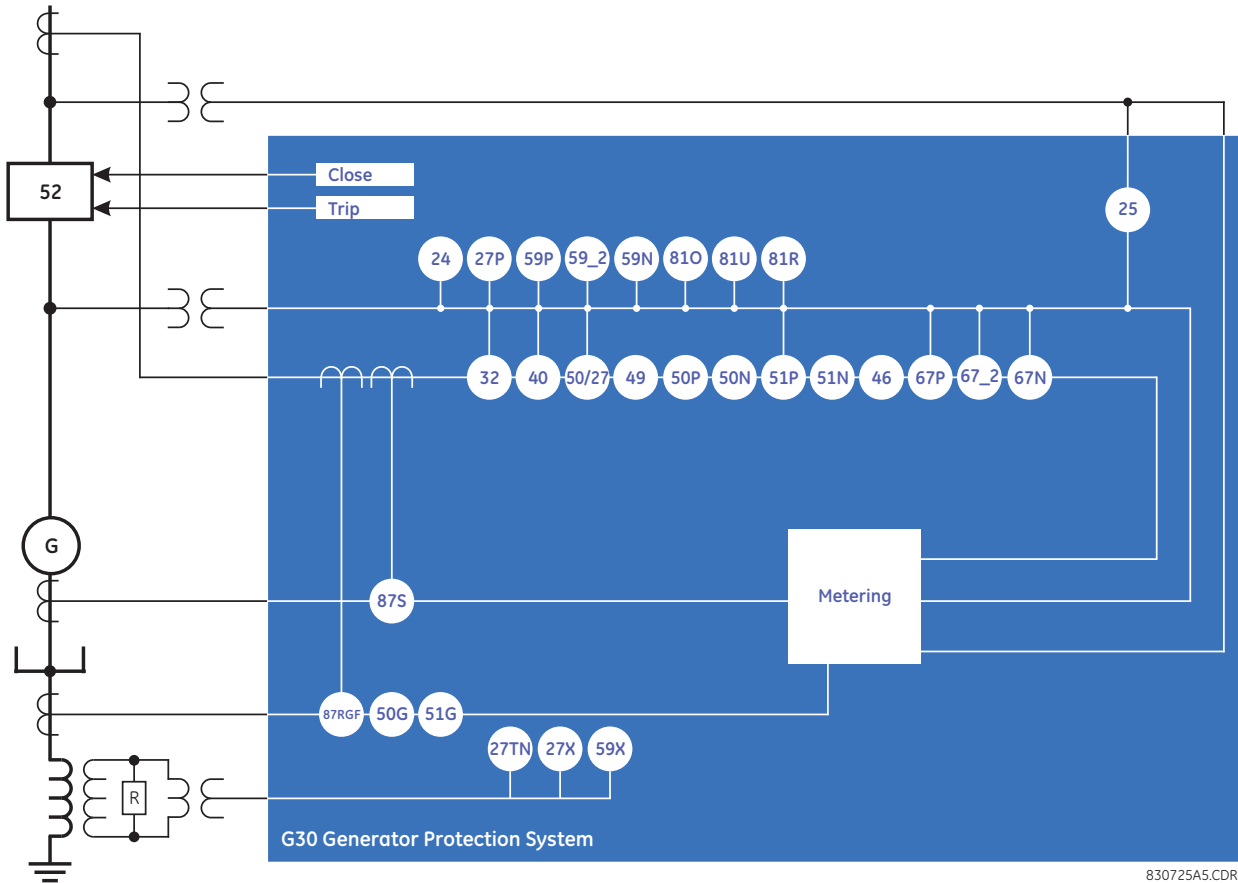


Table 2-2: Other device functions

Function	Function	Function
Breaker arcing current ( $I^2t$ )	FlexLogic equations	Transducer inputs and outputs
Breaker control	FlexElements™ (16)	Transformer aging factor
Contact inputs (up to 120)	IEC 60870-5-103 communications	Transformer hottest-spot temperature
Contact outputs (up to 72)	IEC 61850 communications	Transformer loss-of-life
Control pushbuttons	IEC 62351-9 data and communications security	Trip bus
CT failure detector	Metering: current, voltage, power, frequency, current THD, voltage THD	User-definable displays
CyberSentry™ security	Oscillography	User-programmable fault reports
Data logger	Modbus communications	User-programmable LEDs
Digital counters (8)	Modbus user map	User-programmable pushbuttons
Digital elements (48)	Non-volatile latches	User-programmable self-tests
Direct inputs and outputs (32)	Non-volatile selector switch	Virtual inputs (64)
Disconnect switches	Percent differential	Virtual outputs (96)
DNP 3.0 or IEC 60870-5-104 protocol	Setting groups (6)	VT fuse failure
Ethernet Global Data Protocol	Time synchronization over IRIG-B or IEEE 1588	
Event recorder	Time synchronization over SNTP	

## 2.2 Security

The following security features are available:

- Password security — Basic security present by default
- EnerVista security — Role-based access to various EnerVista software screens and configuration elements. The feature is present by default in the EnerVista software.
- CyberSentry security — Advanced security available using a software option. When purchased, the option is enabled automatically, and the default Password security and EnerVista security are disabled.

### 2.2.0.1 EnerVista security

The EnerVista security management system is a role-based access control (RBAC) system that allows an administrator to manage the privileges of multiple users. This allows for access control of UR devices by multiple personnel within a substation and conforms to the principles of RBAC as defined in ANSI INCITS 359-2004. The EnerVista security management system is disabled by default to allow the administrator direct access to the EnerVista software after installation. It is recommended that security be enabled before placing the device in service.

Basic password or enhanced CyberSentry security applies, depending on purchase.

### 2.2.0.2 Password security

Password security is a basic security feature present by default.

Two levels of password security are provided: command and setting. Use of a password for each level controls whether all users can enter commands and/or change settings.

Two types of connection security are provided: password entry from local or remote connection. Local access is defined as access to settings or commands via the front panel interface. This includes both keypad entry and the through a front panel port. Remote access is defined as access to settings or commands via any rear communications port. This includes both Ethernet and RS485 connections. These two settings are on by default and apply to all users.

When entering a settings or command password via EnerVista or any serial interface, the user must enter the corresponding connection password. If the connection is to the back of the G30, the remote password is used. If the connection is to a front panel port, the local password applies. (These two local and remote password settings are not shown the figure.)

Password access events are logged in the Event Recorder.

Figure 2-4: Access control by passwords and connection type

SETTING	PARAMETER
Command Password	Change
Setting Password	Change
Command Password Access Timeout	5 min
Setting Password Access Timeout	30 min
Invalid Password Attempts	3
Password Lockout Duration	5 min
Password Access Events	Disabled
Local Setting Authorized	ON
Remote Setting Authorized	ON
Access Authorized Timeout	30 min

### 2.2.0.3 CyberSentry security

CyberSentry security is available using software options that provide advanced security. When the option is purchased, the basic password security is disabled automatically.

CyberSentry provides security through the following features:

- An Authentication, Authorization, Accounting (AAA) Remote Authentication Dial-In User Service (RADIUS) client that is managed centrally, enables user attribution, provides accounting of all user activities, and uses secure standards-based strong cryptography for authentication and credential protection. In other words, this option uses a RADIUS server for user authentication.
- A Role-Based Access Control (RBAC) system that provides a permission model that allows access to UR device operations and configurations based on specific roles and individual user accounts configured on the AAA server. That is, Administrator, Supervisor, Engineer, Operator, and Observer roles are used.
- Security event reporting through the Syslog protocol for supporting Security Information Event Management (SIEM) systems for centralized cybersecurity monitoring
- Strong encryption of all access and configuration network messages between the EnerVista software and UR devices using the Secure Shell (SSH) protocol, the Advanced Encryption Standard (AES), and 128-bit keys in Galois Counter Mode (GCM) as specified in the U.S. National Security Agency Suite B extension for SSH and approved by the National Institute of Standards and Technology (NIST) FIPS-140-2 standards for cryptographic systems

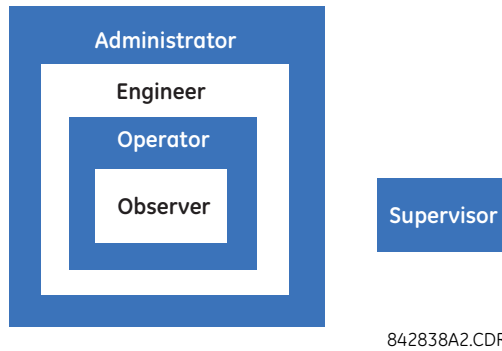
### CyberSentry user roles

CyberSentry user roles (Administrator, Supervisor, Engineer, Operator, Observer) limit the levels of access to various UR functions. This means that the EnerVista software allows for access to functionality based on the user's logged in role.

**Example:** Administrative functions can be segmented from common operator functions, or engineering type access, all of which are defined by separate roles so that access of UR devices by multiple personnel within a substation is allowed.

One role of one type is allowed to be logged in at a time. For example, one Operator can be logged in but not a second Operator at the same time. This prevents subsets of settings from being changed at the same time.

Figure 2-5: CyberSentry user roles



The table lists user roles and permissions.

Table 2-3: Permissions by user role with CyberSentry

	Administrator	Engineer	Operator	Supervisor	Observer
Summary	Complete access	Complete access except for CyberSentry Security	Command menu	Authorizes writing	Default role
Device Definition	R	R	R	R	R
Settings					
----- Product Setup					



	Administrator	Engineer	Operator	Supervisor	Observer
----- Security (CyberSentry)	RW	R	R	R	R
----- Supervisory	See table notes	R	R	See table notes	R
----- Display Properties	RW	RW	R	R	R
----- Clear Relay Records (settings)	RW	RW	R	R	R
----- Communications	RW	RW	R	R	R
----- Modbus User Map	RW	RW	R	R	R
----- Real Time Clock	RW	RW	R	R	R
----- Oscillography	RW	RW	R	R	R
----- Data Logger	RW	RW	R	R	R
----- Demand	RW	RW	R	R	R
----- User-Programmable LEDs	RW	RW	R	R	R
----- User-Programmable Self Tests	RW	RW	R	R	R
----- Control Pushbuttons	RW	RW	R	R	R
----- User-Programmable Pushbuttons	RW	RW	R	R	R
----- Flex state Parameters	RW	RW	R	R	R
----- User-Definable Displays	RW	RW	R	R	R
----- Direct I/O	RW	RW	R	R	R
----- Teleprotection	RW	RW	R	R	R
----- Installation	RW	RW	R	R	R
----- System Setup	RW	RW	R	R	R
----- FlexLogic	RW	RW	R	R	R
----- Grouped Elements	RW	RW	R	R	R
----- Control Elements	RW	RW	R	R	R
----- Inputs / Outputs	RW	RW	R	R	R
----- Contact Inputs	RW	RW	R	R	R
----- Contact Input threshold	RW	RW	R	R	R
----- Virtual Inputs	RW	RW	R	R	R
----- Contact Outputs	RW	RW	R	R	R
----- Virtual Outputs	RW	RW	R	R	R
----- Resetting	RW	RW	R	R	R
----- Direct Inputs	RW	RW	R	R	R
----- Direct Outputs	RW	RW	R	R	R
----- Teleprotection	RW	RW	R	R	R
----- Direct Analogs	RW	RW	R	R	R
----- Direct Integers	RW	RW	R	R	R
----- Transducer I/O	RW	RW	R	R	R
----- Testing	RW	RW	R	R	R
----- Front Panel Label Designer	NA	NA	NA	NA	NA
----- Protection Summary	NA	NA	NA	NA	NA
Commands	RW	RW	RW	R	R
----- Virtual Inputs	RW	RW	RW	R	R

	Administrator	Engineer	Operator	Supervisor	Observer
----- Clear Records	RW	RW	RW	R	R
----- Set Date and Time	RW	RW	RW	R	R
User Displays	R	R	R	R	R
Targets	R	R	R	R	R
Actual Values	R	R	R	R	R
----- Front Panel	R	R	R	R	R
----- Status	R	R	R	R	R
----- Metering	R	R	R	R	R
----- Transducer I/O	R	R	R	R	R
----- Records	R	R	R	R	R
----- Product Info	R	R	R	R	R
Maintenance	RW	RW	R	R	R
----- Modbus Analyzer	NA	NA	NA	NA	NA
----- Change front panel	RW	RW	RW	R	R
----- Update firmware	Yes	No	No	No	No
----- Retrieve file	Yes	No	No	No	No

Table Notes:

RW = read and write access

R = read access

Supervisor = RW (default), Administrator = R (default), Administrator = RW (only if Supervisor role is disabled)

NA = the permission is not enforced by CyberSentry security

### CyberSentry user authentication

The following types of authentication are supported by CyberSentry to access the UR device:

- Device Authentication (local UR device authenticates)
- Server Authentication (RADIUS server authenticates)

The EnerVista software allows access to functionality that is determined by the user role, which comes either from the local UR device or the RADIUS server.

The EnerVista software has a device authentication option on the login screen for accessing the UR device. When the "Device" button is selected, the UR uses its local authentication database and not the RADIUS server to authenticate the user. In this case, it uses its built-in roles (Administrator, Engineer, Supervisor, Observer, Operator, or Administrator and Supervisor when Device Authentication is disabled) as login names and the associated passwords are stored on the UR device. As such, when using the local accounts, access is not user-attributable.

In cases where user-attributable access is required especially to facilitate auditable processes for compliance reasons, use RADIUS authentication.

When the "Server" Authentication Type option is selected, the UR uses the RADIUS server and not its local authentication database to authenticate the user.

No password or security information is displayed in plain text by the EnerVista software or UR device, nor is such information ever transmitted without cryptographic protection.

### CyberSentry server authentication

The UR has been designed to direct automatically the authentication requests based on user names. In this respect, local account names on the UR are considered as reserved and not used on a RADIUS server.

The UR detects automatically whether an authentication request is to be handled remotely or locally. As there are five local accounts possible on the UR, if the user ID credential does not match one of the five local accounts, the UR forwards automatically the request to a RADIUS server when one is provided.

If a RADIUS server is provided, but is unreachable over the network, server authentication requests are denied. In this situation, use local UR accounts to gain access to the UR system.

## 2.3 Order codes

The order code is on the product label and indicates the product options applicable.

The G30 is available as a 19-inch rack horizontal mount or reduced-size (¾) vertical unit. It consists of the following modules: power supply, CPU, CT/VT, contact input and output, transducer input and output, and inter-relay communications. Module options are specified at the time of ordering.

The order codes shown here are subject to change without notice. See the web page for the product for the latest options.

The order code depends on the mounting option (horizontal or vertical) and the type of CT/VT modules (enhanced diagnostic CT/VT modules or HardFiber™ process bus module). The process bus module provides an interface to HardFiber Bricks.



The R-GOOSE protocol described in IEC 61850-8-1 is available through the IEC 61850 software option. R-GOOSE security requires the CyberSentry software option.

For Japanese, the settings display in Japanese on the graphical front panel, while the keys printed on the panel are in English.

### 2.3.1 Order codes with enhanced CT/VT modules

Table 2-4: G30 order codes for horizontal units

BASE UNIT	G30	-	*	**	-	*	*	-	F	**	-	H	**	-	M	**	-	P	**	-	U	**	-	W/X	**	Full Size Horizontal Mount
CPU	G30	T																								Base Unit RS485 and Three Multi-mode fiber 100Base-FX (SFP with LC) RS485 and Two Multi-mode fiber 100Base-FX (SFP with LC), One 10/100Base-TX (SFP with RJ45) RS485 and Three 10/100Base-TX (SFP with RJ45) RS485 with Two 100Base-FX Ethernet, multimode ST + 10/100Base-TX Ethernet, RJ-45
SOFTWARE OPTIONS		V																								No Software Options
		W																								Ethernet Global Data (EGD) IEC 61850 Ethernet Global Data (EGD) and IEC 61850 CyberSentry Lvl 1 CyberSentry Lvl 1 and Ethernet Global Data (EGD) CyberSentry Lvl 1 and IEC 61850 CyberSentry Lvl 1 and IEC 61850 and Ethernet Global Data (EGD) IEEE 1588 IEEE 1588 and Ethernet Global Data (EGD) IEEE 1588 and IEC 61850 IEEE 1588 and IEC 61850 and Ethernet Global Data (EGD) Parallel Redundancy Protocol (PRP) PRP and Ethernet Global Data PRP and IEC 61850 PRP, Ethernet Global Data, and IEC 61850 IEEE 1588 and CyberSentry Lvl 1 IEEE 1588 and CyberSentry Lvl 1 and Ethernet Global Data (EGD) IEEE 1588 and CyberSentry Lvl 1 and IEC 61850 IEEE 1588 and CyberSentry Lvl 1 and IEC 61850 and Ethernet Global Data (EGD) IEEE 1588 and PRP IEEE 1588, PRP, and Ethernet Global Data IEEE 1588, PRP, and IEC 61850 IEEE 1588, PRP, Ethernet Global Data, and IEC 61850 PRP and CyberSentry Lvl1 PRP, CyberSentry Lvl1, and Ethernet Global Data PRP, CyberSentry Lvl 1, and IEC 61850 PRP, CyberSentry Lvl 1, Ethernet Global Data, and IEC 61850 IEEE 1588, PRP, and CyberSentry Lvl 1 IEEE 1588, PRP, CyberSentry Lvl 1, Ethernet Global Data IEEE 1588, PRP, CyberSentry Lvl 1, and IEC 61850 IEEE 1588, PRP, CyberSentry Lvl 1, Ethernet Global Data, and IEC 61850 IEC 60870-5-103 IEC 60870-5-103 + EGD IEC 60870-5-103 + IEC 61850 IEC 60870-5-103 + EGD + IEC 61850 IEEE 1588 + PRP + IEC 60870-5-103 IEEE 1588 + PRP + IEC 60870-5-103 + EGD IEEE 1588 + PRP + IEC 60870-5-103 + IEC 61850 IEEE 1588 + PRP + IEC 60870-5-103 + EGD + IEC 61850 IEC 60870-5-103 + IEEE 1588 + PRP + CyberSentry Lvl 1 IEC 60870-5-103 + IEEE 1588 + PRP + CyberSentry Lvl 1 + EGD IEC 60870-5-103 + IEEE 1588 + PRP + CyberSentry Lvl 1 + IEC 61850 IEC 60870-5-103 + IEEE 1588 + PRP + CyberSentry Lvl 1 + EGD + IEC 61850

	G30	- *	**	- *	* -	P **	- H **	- M **	- P **	- U **	- W/X **			
MOUNT/COATING	H											Full Size Horizontal Mount		
	A											Horizontal (19" rack)		
FRONT PANEL + INTERFACE	C											Horizontal (19" rack) with harsh environmental coating		
	D											English display		
	R											French display		
	A											Russian display		
	P											Chinese display		
	G											English display with 4 small and 12 large programmable pushbuttons		
	S											French display with 4 small and 12 large programmable pushbuttons		
	B											Russian display with 4 small and 12 large programmable pushbuttons		
	K											Chinese display with 4 small and 12 large programmable pushbuttons		
	M											Enhanced front panel with English display		
	Q											Enhanced front panel with French display		
	U											Enhanced front panel with Russian display		
	L											Enhanced front panel with Chinese display		
	N											Enhanced front panel with English display and user-programmable pushbuttons		
	T											Enhanced front panel with French display and user-programmable pushbuttons		
	V											Enhanced front panel with Russian display and user-programmable pushbuttons		
	W											Enhanced front panel with Chinese display and user-programmable pushbuttons		
	Y											Enhanced front panel with Turkish display		
	I											Enhanced front panel with Turkish display and user-programmable pushbuttons		
	J											Enhanced front panel with German display		
	H											Enhanced front panel with German display and user-programmable pushbuttons		
	O											Enhanced front panel with Polish display		
	E											Enhanced front panel with Polish display and user-programmable pushbuttons		
												7" Graphical front panel display in multiple languages with USB front port and user-programmable pushbuttons (English, French, Chinese, Russian, Turkish, German, Polish, Japanese)		
POWER SUPPLY	H											125 / 250 V AC/DC power supply		
(redundant supply must be same type as main supply)	L											125 / 250 V AC/DC with redundant 125 / 250 V AC/DC power supply		
	L											24 to 48 V (DC only) power supply		
	L											24 to 48 V (DC only) with redundant 24 to 48 V DC power supply		
ENHANCED DIAGNOSTICS CT/VT DSP								XX				No DSP module (slot M only)		
(requires all DSP to be enhanced diagnostic)								8L				Standard 4CT/4VT with enhanced diagnostics		
								8M				Sensitive Ground 4CT/4VT with enhanced diagnostics		
								8N				Standard 8CT with enhanced diagnostics		
								8R				Sensitive Ground 8CT with enhanced diagnostics		
CONTACT INPUTS/OUTPUTS								XX				No Module		
								4A	4A	4A	4A	4A	4 Solid-State (no monitoring) MOSFET outputs	
								4B	4B	4B	4B	4B	4 Solid-State (voltage with optional current) MOSFET outputs	
								4C	4C	4C	4C	4C	4 Solid-State (current with optional voltage) MOSFET outputs	
								4D	4D	4D	4D	4D	16 Contact inputs with Auto-Burnishing (maximum of three modules within a case)	
								4L	4L	4L	4L	4L	14 Form-A (no monitoring) Latching outputs	
								67	67	67	67	67	8 Form-A (no monitoring) outputs	
								6A	6A	6A	6A	6A	2 Form-A (voltage with optional current) and 2 Form-C outputs, 8 contact inputs	
								6B	6B	6B	6B	6B	2 Form-A (voltage with optional current) and 4 Form-C outputs, 4 contact inputs	
								6C	6C	6C	6C	6C	8 Form-C outputs	
								6D	6D	6D	6D	6D	16 Contact inputs	
								6E	6E	6E	6E	6E	4 Form-C outputs, 8 contact inputs	
								6F	6F	6F	6F	6F	8 Fast Form-C outputs	
								6G	6G	6G	6G	6G	4 Form-A (voltage with optional current) outputs, 8 contact inputs	
								6H	6H	6H	6H	6H	6 Form-A (voltage with optional current) outputs, 8 contact inputs	
								6K	6K	6K	6K	6K	4 Form-C and 4 Fast Form-C outputs	
								6L	6L	6L	6L	6L	2 Form-A (current with optional voltage) and 2 Form-C outputs, 8 contact inputs	
								6M	6M	6M	6M	6M	2 Form-A (current with optional voltage) and 4 Form-C outputs, 4 contact inputs	
								6N	6N	6N	6N	6N	4 Form-A (current with optional voltage) outputs, 8 contact inputs	
								6P	6P	6P	6P	6P	6 Form-A (current with optional voltage) outputs, 4 contact inputs	
								6R	6R	6R	6R	6R	2 Form-A (no monitoring) and 2 Form-C outputs, 8 contact inputs	
								6S	6S	6S	6S	6S	2 Form-A (no monitoring) and 4 Form-C outputs, 4 contact inputs	
								6T	6T	6T	6T	6T	4 Form-A (no monitoring) outputs, 8 contact inputs	
								6U	6U	6U	6U	6U	6 Form-A (no monitoring) outputs, 4 contact inputs	
								6V	6V	6V	6V	6V	2 Form-A outputs, 1 Form-C output, 2 Form-A (no monitoring) latching outputs, 8 contact inputs	
								6W	6W	6W	6W	6W	30 Contact inputs - pin terminals (max 4 modules)	
								6X	6X	6X	6X	6X	18 Form-A (no monitoring) outputs - pin terminals (max 4 modules)	
TRANSDUCER INPUTS/OUTPUTS								5A	5A	5A	5A	5A	4 DCmA inputs, 4 DCmA outputs (only one 5A or 5D module is allowed)	
(select a maximum of 3 per unit)								5C	5C	5C	5C	5C	8 RTD inputs	
								5D	5D	5D	5D	5D	4 RTD inputs, 4 DCmA outputs (only one 5A or 5D module is allowed)	
								5E	5E	5E	5E	5E	4 RTD inputs, 4 DCmA inputs	
								5F	5F	5F	5F	5F	8 DCmA inputs	
INTER-RELAY COMMUNICATIONS													2A	C37.94SM, 1300nm single-mode, ELED, 1 channel single-mode
(select a maximum of 1 per unit)													2B	C37.94SM, 1300nm single-mode, ELED, 2 channel single-mode
													2E	Bi-phase, single channel
													2F	Bi-phase, dual channel
													2G	IEEE C37.94, 820 nm, 128 kbps, multimode, LED, 1 Channel
													2H	IEEE C37.94, 820 nm, 128 kbps, multimode, LED, 2 Channels
													2I	Channel 1 - IEEE C37.94, MM, 64/128 kbps; Channel 2 - 1300 nm, single-mode, Laser
													2J	Channel 1 - IEEE C37.94, MM, 64/128 kbps; Channel 2 - 1550 nm, single-mode, Laser
													72	1550 nm, single-mode, LASER, 1 Channel
													73	1550 nm, single-mode, LASER, 2 Channel
													74	Channel 1 - RS422; Channel 2 - 1550 nm, single-mode, Laser
													75	Channel 1 - G.703; Channel 2 - 1550 nm, single-mode Laser
													76	IEEE C37.94, 820 nm, 64 kbps, multimode, LED, 1 Channel
													77	IEEE C37.94, 820 nm, 64 kbps, multimode, LED, 2 Channels
													7A	820 nm, multimode, LED, 1 Channel
													7B	1300 nm, multimode, LED, 1 Channel
													7C	1300 nm, single-mode, ELED, 1 Channel
													7D	1300 nm, single-mode, Laser, 1 Channel
													7E	Channel 1 - G.703; Channel 2 - 820 nm, multimode
													7F	Channel 1 - G.703; Channel 2 - 1300 nm, multimode
													7G	Channel 1 - G.703; Channel 2 - 1300 nm, single-mode ELED
													7H	820 nm, multimode, LED, 2 Channels
													7I	1300 nm, multimode, LED, 2 Channels
													7J	1300 nm, single-mode, ELED, 2 Channels
													7K	1300 nm, single-mode, Laser, 2 Channels
													7L	Channel 1 - RS422; Channel 2 - 820 nm, multimode, LED
													7M	Channel 1 - RS422; Channel 2 - 1300 nm, multimode, LED
													7N	Channel 1 - RS422; Channel 2 - 1300 nm, single-mode, ELED
													7P	Channel 1 - RS422; Channel 2 - 1300 nm, single-mode, Laser
													7Q	Channel 1 - G.703; Channel 2 - 1300 nm, single-mode Laser
													7R	G.703, 1 Channel

G30	-	*	**	-	*	*	*	-	F	**	-	H	**	-	M	**	-	P	**	-	U	**	-	W/X	**	Full Size Horizontal Mount
																									7S	G,703, 2 Channels
																									7T	RS422, 1 Channel
																									7W	RS422, 2 Channels

Table 2-5: G30 order codes for reduced-size vertical units

Category	Code	Description
BASE UNIT	G30	Reduced Size Vertical Mount (see note regarding P/R slot below)
CPU	T	Base Unit
	U	RS485 and Three Multi-mode fiber 100Base-FX (SFP with LC)
	V	RS485 and Two Multi-mode fiber 100Base-FX (SFP with LC), One 10/100Base-TX (SFP with RJ45)
	W	RS485 and Three 10/100Base-TX (SFP with RJ45)
SOFTWARE OPTIONS	00	RS485 with Two 100Base-FX Ethernet, multimode ST + 10/100Base-TX Ethernet, RJ-45
	01	No Software Options
	03	Ethernet Global Data (EGD)
	04	IEC 61850
	A0	Ethernet Global Data (EGD) and IEC 61850
	A1	CyberSentry Lvl 1
	A3	CyberSentry Lvl 1 and Ethernet Global Data (EGD)
	A4	CyberSentry Lvl 1 and IEC 61850
	B0	CyberSentry Lvl 1 and IEC 61850 and Ethernet Global Data (EGD)
	B1	IEEE 1588
	B3	IEEE 1588 and Ethernet Global Data (EGD)
	B4	IEEE 1588 and IEC 61850
	C0	IEEE 1588 and IEC 61850 and Ethernet Global Data (EGD)
	C1	Parallel Redundancy Protocol (PRP)
	C3	PRP and Ethernet Global Data
	C4	PRP and IEC 61850
	D0	PRP, Ethernet Global Data, and IEC 61850
	D1	IEEE 1588 and CyberSentry Lvl 1
	D3	IEEE 1588 and CyberSentry Lvl 1 and Ethernet Global Data (EGD)
	D4	IEEE 1588 and CyberSentry Lvl 1 and IEC 61850
	E0	IEEE 1588 and CyberSentry Lvl 1 and IEC 61850 and Ethernet Global Data (EGD)
	E1	IEEE 1588 and PRP
	E3	IEEE 1588, PRP, and Ethernet Global Data
	E4	IEEE 1588, PRP, and IEC 61850
	F0	IEEE 1588, PRP, Ethernet Global Data, and IEC 61850
	F1	PRP and CyberSentry Lvl1
	F3	PRP, CyberSentry Lvl1, and Ethernet Global Data
	F4	PRP, CyberSentry Lvl 1, and IEC 61850
	G0	PRP, CyberSentry Lvl 1, Ethernet Global Data, and IEC 61850
	G1	IEEE 1588, PRP, and CyberSentry Lvl 1
	G3	IEEE 1588, PRP, CyberSentry Lvl 1, Ethernet Global Data
	G4	IEEE 1588, PRP, CyberSentry Lvl 1, and IEC 61850
	J0	IEEE 1588, PRP, CyberSentry Lvl 1, Ethernet Global Data, and IEC 61850
	J1	IEC 60870-5-103
	J3	IEC 60870-5-103 + EGD
	J4	IEC 60870-5-103 + IEC 61850
	K0	IEC 60870-5-103 + EGD + IEC 61850
	K1	IEEE 1588 + PRP + IEC 60870-5-103
	K3	IEEE 1588 + PRP + IEC 60870-5-103 + EGD
	K4	IEEE 1588 + PRP + IEC 60870-5-103 + IEC 61850
	L0	IEEE 1588 + PRP + IEC 60870-5-103 + EGD + IEC 61850
	L1	IEC 60870-5-103 + IEEE 1588 + PRP + CyberSentry Lvl 1
	L3	IEC 60870-5-103 + IEEE 1588 + PRP + CyberSentry Lvl 1 + EGD
	L4	IEC 60870-5-103 + IEEE 1588 + PRP + CyberSentry Lvl 1 + IEC 61850
MOUNT/COATING	V	Vertical (3/4 rack)
	B	Vertical (3/4 rack) with harsh environmental coating
FRONT PANEL + INTERFACE	F	English display
	D	French display
	R	Russian display
	A	Chinese display
	K	Enhanced front panel with English display
	M	Enhanced front panel with French display
	Q	Enhanced front panel with Russian display
	U	Enhanced front panel with Chinese display
	L	Enhanced front panel with English display and user-programmable pushbuttons
	N	Enhanced front panel with French display and user-programmable pushbuttons
	T	Enhanced front panel with Russian display and user-programmable pushbuttons
	V	Enhanced front panel with Chinese display and user-programmable pushbuttons
	W	Enhanced front panel with Turkish display
	Y	Enhanced front panel with Turkish display and user-programmable pushbuttons
	I	Enhanced front panel with German display
	J	Enhanced front panel with German display and user-programmable pushbuttons



	G30	-	*	**	-	*	*	-	F	**	-	H	**	-	M	**	-	P/R	**	
POWER SUPPLY																				Reduced Size Vertical Mount (see note regarding P/R slot below)
																				125 / 250 V AC/DC power supply
																				24 to 48 V (DC only) power supply
ENHANCED DIAGNOSTICS CT/VT																				No DSP module (slot M only)
DSP										8L										Standard 4CT/4VT with enhanced diagnostics
(requires all DSP to be enhanced diagnostic)										8M										Sensitive Ground 4CT/4VT with enhanced diagnostics
										8N										Standard 8CT with enhanced diagnostics
										8R										Sensitive Ground 8CT with enhanced diagnostics
CONTACT INPUTS/OUTPUTS																				No Module
																				4 Solid-State (no monitoring) MOSFET outputs
																				4 Solid-State (voltage with optional current) MOSFET outputs
																				4 Solid-State (current with optional voltage) MOSFET outputs
																				16 Contact inputs with Auto-Burnishing (maximum of three modules within a case)
																				14 Form-A (no monitoring) Latching outputs
																				8 Form-A (no monitoring) outputs
																				2 Form-A (voltage with optional current) and 2 Form-C outputs, 8 contact inputs
																				2 Form-A (voltage with optional current) and 4 Form-C outputs, 4 contact inputs
																				8 Form-C outputs
																				16 Contact inputs
																				4 Form-C outputs, 8 contact inputs
																				8 Fast Form-C outputs
																				4 Form-A (voltage with optional current) outputs, 8 contact inputs
																				6 Form-A (voltage with optional current) outputs, 4 contact inputs
																				4 Form-C and 4 Fast Form-C outputs
																				2 Form-A (current with optional voltage) and 2 Form-C outputs, 8 contact inputs
																				2 Form-A (current with optional voltage) and 4 Form-C outputs, 4 contact inputs
																				4 Form-A (current with optional voltage) outputs, 8 contact inputs
																				6 Form-A (current with optional voltage) outputs, 4 contact inputs
																				2 Form-A (no monitoring) and 2 Form-C outputs, 8 contact inputs
																				2 Form-A (no monitoring) and 4 Form-C outputs, 4 contact inputs
																				4 Form-A (no monitoring) outputs, 8 contact inputs
																				6 Form-A (no monitoring) outputs, 4 contact inputs
																				2 Form-A outputs, 1 Form-C output, 2 Form-A (no monitoring) latching outputs, 8 contact inputs
																				30 Contact inputs - pin terminals (max 4 modules)
																				18 Form-A (no monitoring) outputs - pin terminals (max 4 modules)
TRANSDUCER INPUTS/OUTPUTS										5A		5A								4 DCmA inputs, 4 DCmA outputs (only one 5A or 5D module is allowed)
										5C		5C								8 RTD inputs
										5D		5D								4 RTD inputs, 4 DCmA outputs (only one 5A or 5D module is allowed)
										5E		5E								4 RTD inputs, 4 DCmA inputs
										5F		5F								8 DCmA inputs
INTER-RELAY COMMUNICATIONS																				2A C37.94SM, 1300 nm single-mode, ELED, 1 channel single-mode
(select a maximum of 1 per unit)																				2B C37.94SM, 1300 nm single-mode, ELED, 2 channel single-mode
For the last module, rear slot P is used for digital and transducer input/output modules; rear slot R is used for inter-relay communications modules.																				2E Bi-phase, single channel
																				2F Bi-phase, dual channel
																				2G IEEE C37.94, 820 nm, 128 kbps, multimode, LED, 1 Channel
																				2H IEEE C37.94, 820 nm, 128 kbps, multimode, LED, 2 Channels
																				2I Channel 1 - IEEE C37.94, MM, 64/128 kbps; Channel 2 - 1300 nm, single-mode, Laser
																				2J Channel 1 - IEEE C37.94, MM, 64/128 kbps; Channel 2 - 1550 nm, single-mode, Laser
																				72 1550 nm, single-mode, LASER, 1 Channel
																				73 1550 nm, single-mode, LASER, 2 Channel
																				74 Channel 1 - RS422; Channel 2 - 1550 nm, single-mode, Laser
																				75 Channel 1 - G.703; Channel 2 - 1550 nm, single-mode Laser
																				76 IEEE C37.94, 820 nm, 64 kbps, multimode, LED, 1 Channel
																				77 IEEE C37.94, 820 nm, 64 kbps, multimode, LED, 2 Channels
																				7A 820 nm, multimode, LED, 1 Channel
																				7B 1300 nm, multimode, LED, 1 Channel
																				7C 1300 nm, single-mode, ELED, 1 Channel
																				7D 1300 nm, single-mode, LASER, 1 Channel
																				7E Channel 1 - G.703; Channel 2 - 820 nm, multimode
																				7F Channel 1 - G.703; Channel 2 - 1300 nm, multimode
																				7G Channel 1 - G.703; Channel 2 - 1300 nm, single-mode ELED
																				7H 820 nm, multimode, LED, 2 Channels
																				7I 1300 nm, multimode, LED, 2 Channels
																				7J 1300 nm, single-mode, ELED, 2 Channels
																				7K 1300 nm, single-mode, Laser, 2 Channels
																				7L Channel 1 - RS422; Channel 2 - 820 nm, multimode, LED
																				7M Channel 1 - RS422; Channel 2 - 1300 nm, multimode, LED
																				7N Channel 1 - RS422; Channel 2 - 1300 nm, single-mode, ELED
																				7P Channel 1 - RS422; Channel 2 - 1300 nm, single-mode, Laser
																				7Q Channel 1 - G.703; Channel 2 - 1300 nm, single-mode Laser
																				7R G.703, 1 Channel
																				7S G.703, 2 Channels
																				7T RS422, 1 Channel
																				7W RS422, 2 Channels

### 2.3.2 Order codes with process bus modules

Table 2-6: G30 order codes for horizontal units with process bus

	G30	-	*	**	-	*	*	-	F	**	-	H	**	-	M	**	-	P	**	-	U	**	-	W/X	**	
BASE UNIT	G30																									Full Size Horizontal Mount
CPU																										Base Unit
																										RS485 and Three Multi-mode fiber 100Base-FX (SFP with LC)
																										RS485 and Two Multi-mode fiber 100Base-FX (SFP with LC), One 10/100Base-TX (SFP with RJ45)
																										RS485 and Three 10/100Base-TX (SFP with RJ45)
																										RS485 with Two 100Base-FX Ethernet, multimode ST + 10/100Base-TX Ethernet, RJ-45





G30 - * ** - * * * - P ** - H ** - M ** - P ** - U ** - W/X **		Full Size Horizontal Mount
INTER-RELAY COMMUNICATIONS (select a maximum of 1 per unit)		18 Form-A (no monitoring) outputs - pin terminals (max 4 modules)
2A	C37.94SM, 1300 nm single-mode, ELED, 1 channel single-mode	
2B	C37.94SM, 1300 nm single-mode, ELED, 2 channel single-mode	
2E	Bi-phase, single channel	
2F	Bi-phase, dual channel	
2G	IEEE C37.94, 820 nm, 128 kbps, multimode, LED, 1 Channel	
2H	IEEE C37.94, 820 nm, 128 kbps, multimode, LED, 2 Channels	
2I	Channel 1 - IEEE C37.94, MM, 64/128 kbps; Channel 2 - 1300 nm, single-mode, Laser	
2J	Channel 1 - IEEE C37.94, MM, 64/128 kbps; Channel 2 - 1550 nm, single-mode, Laser	
72	1550 nm, single-mode, Laser, 1 Channel	
73	1550 nm, single-mode, Laser, 2 Channel	
74	Channel 1 - RS422; Channel 2 - 1550 nm, single-mode, Laser	
75	Channel 1 - G.703; Channel 2 - 1550 nm, single-mode Laser	
76	IEEE C37.94, 820 nm, 64 kbps, multimode, LED, 1 Channel	
77	IEEE C37.94, 820 nm, 64 kbps, multimode, LED, 2 Channels	
7A	820 nm, multimode, LED, 1 Channel	
7B	1300 nm, multimode, LED, 1 Channel	
7C	1300 nm, single-mode, ELED, 1 Channel	
7D	1300 nm, single-mode, Laser, 1 Channel	
7E	Channel 1 - G.703; Channel 2 - 820 nm, multimode	
7F	Channel 1 - G.703; Channel 2 - 1300 nm, multimode	
7G	Channel 1 - G.703; Channel 2 - 1300 nm, single-mode ELED	
7H	820 nm, multimode, LED, 2 Channels	
7I	1300 nm, multimode, LED, 2 Channels	
7J	1300 nm, single-mode, ELED, 2 Channels	
7K	1300 nm, single-mode, Laser, 2 Channels	
7L	Channel 1 - RS422; Channel 2 - 820 nm, multimode, LED	
7M	Channel 1 - RS422; Channel 2 - 1300 nm, multimode, LED	
7N	Channel 1 - RS422; Channel 2 - 1300 nm, single-mode, ELED	
7P	Channel 1 - RS422; Channel 2 - 1300 nm, single-mode, Laser	
7Q	Channel 1 - G.703; Channel 2 - 1300 nm, single-mode Laser	
7R	G.703, 1 Channel	
7S	G.703, 2 Channels	
7T	RS422, 1 Channel	
7W	RS422, 2 Channels	

Table 2-7: G30 order codes for reduced-size vertical units with process bus

G30 - * ** - * * * - P ** - H ** - M ** - P/R **		Reduced Size Vertical Mount (see note regarding P/R slot below)
BASE UNIT	G30	Base Unit
CPU	T U V W	RS485 and Three Multi-mode fiber 100Base-FX (SFP with LC) RS485 and Two Multi-mode fiber 100Base-FX (SFP with LC), One 10/100Base-TX (SFP with RJ45) RS485 and Three 10/100Base-TX (SFP with RJ45) RS485 with Two 100Base-FX Ethernet, multimode ST + 10/100Base-TX Ethernet, RJ-45
SOFTWARE OPTIONS	00 01 03 04 A0 A1 A3 A4 B0 B1 B3 B4 C0 C1 C3 C4 D0 D1 D3 D4 E0 E1 E3 E4 F0 F1 F3 F4 G0 G1 G3 G4 J0 J1 J3 J4 K0 K1 K3 K4 L0 L1 L3 L4	No Software Options Ethernet Global Data (EGD) IEC 61850 Ethernet Global Data (EGD) and IEC 61850 CyberSentry Lvl 1 CyberSentry Lvl 1 and Ethernet Global Data (EGD) CyberSentry Lvl 1 and IEC 61850 CyberSentry Lvl 1 and IEC 61850 and Ethernet Global Data (EGD) IEEE 1588 IEEE 1588 and Ethernet Global Data (EGD) IEEE 1588 and IEC 61850 IEEE 1588 and IEC 61850 and Ethernet Global Data (EGD) Parallel Redundancy Protocol (PRP) PRP and Ethernet Global Data PRP and IEC 61850 PRP, Ethernet Global Data, and IEC 61850 IEEE 1588 and CyberSentry Lvl 1 IEEE 1588 and CyberSentry Lvl 1 and Ethernet Global Data (EGD) IEEE 1588 and CyberSentry Lvl 1 and IEC 61850 IEEE 1588 and CyberSentry Lvl 1 and IEC 61850 and Ethernet Global Data (EGD) IEEE 1588 and PRP IEEE 1588, PRP, and Ethernet Global Data IEEE 1588, PRP, and IEC 61850 IEEE 1588, PRP, Ethernet Global Data, and IEC 61850 PRP and CyberSentry Lvl1 PRP, CyberSentry Lvl1, and Ethernet Global Data PRP, CyberSentry Lvl 1, and IEC 61850 PRP, CyberSentry Lvl 1, Ethernet Global Data, and IEC 61850 IEEE 1588, PRP, and CyberSentry Lvl 1 IEEE 1588, PRP, CyberSentry Lvl 1, Ethernet Global Data IEEE 1588, PRP, CyberSentry Lvl 1, and IEC 61850 IEEE 1588, PRP, CyberSentry Lvl 1, Ethernet Global Data, and IEC 61850 IEC 60870-5-103 IEC 60870-5-103 + EGD IEC 60870-5-103 + IEC 61850 IEC 60870-5-103 + EGD + IEC 61850 IEEE1588 + PRP + IEC 60870-5-103 IEEE1588 + PRP + IEC 60870-5-103 + EGD IEEE1588 + PRP + IEC 60870-5-103 + IEC 61850 IEEE1588 + PRP + IEC 60870-5-103 + EGD + IEC 61850 IEC 60870-5-103 + IEEE1588 + PRP + CyberSentry Lvl 1 IEC 60870-5-103 + IEEE1588 + PRP + CyberSentry Lvl 1 + EGD IEC 60870-5-103 + IEEE1588 + PRP + CyberSentry Lvl 1 + IEC 61850 IEC 60870-5-103 + IEEE1588 + PRP + CyberSentry Lvl 1 + EGD + IEC 61850
MOUNT/COATING	V B	Vertical (3/4 rack) Vertical (3/4 rack) with harsh environmental coating
FRONT PANEL + INTERFACE	C D R A K M Q	English display French display Russian display Chinese display Enhanced front panel with English display Enhanced front panel with French display Enhanced front panel with Russian display



Module Type	Code	Description
	G30 - * ** - * * * - P ** - H ** - M ** - P/R **	Reduced Size Vertical Mount (see note regarding P/R slot below)
	U	Enhanced front panel with Chinese display
	L	Enhanced front panel with English display and user-programmable pushbuttons
	N	Enhanced front panel with French display and user-programmable pushbuttons
	T	Enhanced front panel with Russian display and user-programmable pushbuttons
	V	Enhanced front panel with Chinese display and user-programmable pushbuttons
	W	Enhanced front panel with Turkish display
	Y	Enhanced front panel with Turkish display and user-programmable pushbuttons
	I	Enhanced front panel with German display
	J	Enhanced front panel with German display and user-programmable pushbuttons
POWER SUPPLY	H	125 / 250 V AC/DC power supply
	L	24 to 48 V (DC only) power supply
PROCESS BUS MODULE		Eight-port digital process bus module
CONTACT INPUTS/OUTPUTS	XX	No Module
	81	4A 4 Solid-State (no monitoring) MOSFET outputs
	XX	4B 4 Solid-State (voltage with optional current) MOSFET outputs
	XX	4C 4 Solid-State (current with optional voltage) MOSFET outputs
	XX	4D 16 Contact inputs with Auto-Burnishing (maximum of three modules within a case)
	XX	4L 14 Form-A (no monitoring) Latching outputs
	XX	67 8 Form-A (no monitoring) outputs
	XX	6A 2 Form-A (voltage with optional current) and 2 Form-C outputs, 8 contact inputs
	XX	6B 2 Form-A (voltage with optional current) and 4 Form-C outputs, 4 contact inputs
	XX	6C 8 Form-C outputs
	XX	6D 16 Contact inputs
	XX	6E 4 Form-C outputs, 8 contact inputs
	XX	6F 8 Fast Form-C outputs
	XX	6G 4 Form-A (voltage with optional current) outputs, 8 contact inputs
	XX	6H 6 Form-A (voltage with optional current) outputs, 4 contact inputs
	XX	6K 4 Form-C and 4 Fast Form-C outputs
	XX	6L 2 Form-A (current with optional voltage) and 2 Form-C outputs, 8 contact inputs
	XX	6M 2 Form-A (current with optional voltage) and 4 Form-C outputs, 4 contact inputs
	XX	6N 4 Form-A (current with optional voltage) outputs, 8 contact inputs
	XX	6P 6 Form-A (current with optional voltage) outputs, 4 contact inputs
	XX	6R 2 Form-A (no monitoring) and 2 Form-C outputs, 8 contact inputs
	XX	6S 2 Form-A (no monitoring) and 4 Form-C outputs, 4 contact inputs
	XX	6T 4 Form-A (no monitoring) outputs, 8 contact inputs
	XX	6U 6 Form-A (no monitoring) outputs, 4 contact inputs
	XX	6V 2 Form-A outputs, 1 Form-C output, 2 Form-A (no monitoring) latching outputs, 8 contact inputs
	XX	6W 30 Contact inputs - pin terminals (max 4 modules)
	XX	6X 18 Form-A (no monitoring) outputs - pin terminals (max 4 modules)
INTER-RELAY COMMUNICATIONS	2A	C37.94SM, 1300 nm single-mode, ELED, 1 channel single-mode
	2B	C37.94SM, 1300 nm single-mode, ELED, 2 channel single-mode
	2E	Bi-phase, single channel
	2F	Bi-phase, dual channel
	2G	IEEE C37.94, 820 nm, 128 kbps, multimode, LED, 1 Channel
	2H	IEEE C37.94, 820 nm, 128 kbps, multimode, LED, 2 Channels
	2I	Channel 1 - IEEE C37.94, MM, 64/128 kbps; Channel 2 - 1300 nm, single-mode, Laser
	2J	Channel 1 - IEEE C37.94, MM, 64/128 kbps; Channel 2 - 1550 nm, single-mode, Laser
	72	1550 nm, single-mode, Laser, 1 Channel
	73	1550 nm, single-mode, Laser, 2 Channel
	74	Channel 1 - RS422; Channel 2 - 1550 nm, single-mode, Laser
	75	Channel 1 - G.703; Channel 2 - 1550 nm, single-mode Laser
	76	IEEE C37.94, 820 nm, 64 kbps, multimode, LED, 1 Channel
	77	IEEE C37.94, 820 nm, 64 kbps, multimode, LED, 2 Channels
	7A	820 nm, multimode, LED, 1 Channel
	7B	1300 nm, multimode, LED, 1 Channel
	7C	1300 nm, single-mode, ELED, 1 Channel
	7D	1300 nm, single-mode, Laser, 1 Channel
	7E	Channel 1 - G.703; Channel 2 - 820 nm, multimode
	7F	Channel 1 - G.703; Channel 2 - 1300 nm, multimode
	7G	Channel 1 - G.703; Channel 2 - 1300 nm, single-mode ELED
	7H	820 nm, multimode, LED, 2 Channels
	7I	1300 nm, multimode, LED, 2 Channels
	7J	1300 nm, single-mode, ELED, 2 Channels
	7K	1300 nm, single-mode, Laser, 2 Channels
	7L	Channel 1 - RS422; Channel 2 - 820 nm, multimode, LED
	7M	Channel 1 - RS422; Channel 2 - 1300 nm, multimode, LED
	7N	Channel 1 - RS422; Channel 2 - 1300 nm, single-mode, ELED
	7P	Channel 1 - RS422; Channel 2 - 1300 nm, single-mode, Laser
	7Q	Channel 1 - G.703; Channel 2 - 1300 nm, single-mode Laser
	7R	G.703, 1 Channel
	7S	G.703, 2 Channels
	7T	RS422, 1 Channel
	7W	RS422, 2 Channels



### 2.3.3 Replacement modules

Replacement modules can be ordered separately. When ordering a replacement CPU module or front panel, provide the serial number of your existing unit.

Not all replacement modules apply to the G30 relay. The modules specified in the order codes for the G30 are available as replacement modules for the G30.

The order codes shown here are subject to change without notice. See the web page for the product for the latest options.

**Table 2-8: UR order codes for replacement modules, horizontal units**

Module Type	Code	Description
POWER SUPPLY	SH	125 / 300 V AC/DC
redundant supply only available in horizontal units and must be same type as main supply	SL	24 to 48 V (DC only)
CPU	T	RS485 with 3 100Base-FX Ethernet, multimode, SFP with LC
	U	RS485 with 1 100Base-TX Ethernet, SFP RJ-45 + 2 100Base-FX Ethernet, multimode, SFP with LC
	V	RS485 with 3 100Base-TX Ethernet, SFP with RJ-45
	W	RS485 with 2 100Base-FX Ethernet, multimode ST + 10/100Base-TX Ethernet, RJ-45

	UR	- ** - *
FRONT PANEL + INTERFACE	3C	Horizontal front panel with keypad and English display
	3D	Horizontal front panel with keypad and French display
	3R	Horizontal front panel with keypad and Russian display
	3A	Horizontal front panel with keypad and Chinese display
	3P	Horizontal front panel with keypad, user-programmable pushbuttons, and English display
	3G	Horizontal front panel with keypad, user-programmable pushbuttons, and French display
	3S	Horizontal front panel with keypad, user-programmable pushbuttons, and Russian display
	3B	Horizontal front panel with keypad, user-programmable pushbuttons, and Chinese display
	3K	Enhanced front panel with English display
	3M	Enhanced front panel with French display
	3Q	Enhanced front panel with Russian display
	3U	Enhanced front panel with Chinese display
	3L	Enhanced front panel with English display and user-programmable pushbuttons
	3N	Enhanced front panel with French display and user-programmable pushbuttons
	3T	Enhanced front panel with Russian display and user-programmable pushbuttons
	3V	Enhanced front panel with Chinese display and user-programmable pushbuttons
	3I	Enhanced front panel with German display
	3J	Enhanced front panel with German display and user-programmable pushbuttons
	3H	Enhanced front panel with Polish display
	3O	Enhanced front panel with Polish display and user-programmable pushbuttons
	3Z	Enhanced front panel with Japanese display
3X	Enhanced front panel with Japanese display and user-programmable pushbuttons	
3E	7" Graphical front panel display in multiple languages with USB front port and user-programmable pushbuttons	
CONTACT INPUTS AND OUTPUTS	4A	4 Solid-State (no monitoring) MOSFET outputs
	4B	4 Solid-State (voltage with optional current) MOSFET outputs
	4C	4 Solid-State (current with optional voltage) MOSFET outputs
	4D	16 Contact inputs with Auto-Burnishing
	4L	14 Form-A (no monitoring) Latching outputs
	67	8 Form-A (no monitoring) outputs
	6A	2 Form-A (voltage with optional current) and 2 Form-C outputs, 8 contact inputs
	6B	2 Form-A (voltage with optional current) and 4 Form-C outputs, 4 contact inputs
	6C	8 Form-C outputs
	6D	16 Contact inputs
	6E	4 Form-C outputs, 8 contact inputs
	6F	8 Fast Form-C outputs
	6G	4 Form-A (voltage with optional current) outputs, 8 contact inputs
	6H	6 Form-A (voltage with optional current) outputs, 4 contact inputs
	6K	4 Form-C and 4 Fast Form-C outputs
	6L	2 Form-A (current with optional voltage) and 2 Form-C outputs, 8 contact inputs
	6M	2 Form-A (current with optional voltage) and 4 Form-C outputs, 4 contact inputs
	6N	4 Form-A (current with optional voltage) outputs, 8 contact inputs
	6P	6 Form-A (current with optional voltage) outputs, 4 contact inputs
	6R	2 Form-A (no monitoring) and 2 Form-C outputs, 8 contact inputs
	6S	2 Form-A (no monitoring) and 4 Form-C outputs, 4 contact inputs
6T	4 Form-A (no monitoring) outputs, 8 contact inputs	
6U	6 Form-A (no monitoring) outputs, 4 contact inputs	
6V	2 Form-A outputs, 1 Form-C output, 2 Form-A (no monitoring) latching outputs, 8 contact inputs	
6W	30 Contact inputs - pin terminals (max 4 modules)	
6X	18 Form-A (no monitoring) outputs - pin terminals (max 4 modules)	
CT/VT MODULES (not available for the C30)	8L	Standard 4CT/4VT with enhanced diagnostics
	8N	Standard 8CT with enhanced diagnostics
	8M	Sensitive Ground 4CT/4VT with enhanced diagnostics
	8R	Sensitive Ground 8CT with enhanced diagnostics
INTER-RELAY COMMUNICATIONS	2A	C37.94SM, 1300 nm single-mode, ELED, 1 channel single-mode
	2B	C37.94SM, 1300 nm single-mode, ELED, 2 channel single-mode
	2E	Bi-phase, single channel
	2F	Bi-phase, dual channel
	2G	IEEE C37.94, 820 nm, 128 kbps, multimode, LED, 1 Channel
	2H	IEEE C37.94, 820 nm, 128 kbps, multimode, LED, 2 Channels
	2I	Channel 1 - IEEE C37.94, multimode, 64/128 kbps; Channel 2 - 1300 nm, single-mode, Laser
	2J	Channel 1 - IEEE C37.94, multimode, 64/128 kbps; Channel 2 - 1550 nm, single-mode, Laser
	72	1550 nm, single-mode, Laser, 1 Channel
	73	1550 nm, single-mode, Laser, 2 Channel
	74	Channel 1 - RS422; Channel 2 - 1550 nm, single-mode, Laser
	75	Channel 1 - G.703; Channel 2 - 1550 nm, single-mode Laser
	76	IEEE C37.94, 820 nm, multimode, LED, 1 Channel
	77	IEEE C37.94, 820 nm, multimode, LED, 2 Channels
	7A	820 nm, multimode, LED, 1 Channel
	7B	1300 nm, multimode, LED, 1 Channel
	7C	1300 nm, single-mode, ELED, 1 Channel
	7D	1300 nm, single-mode, Laser, 1 Channel
	7E	Channel 1 - G.703; Channel 2 - 820 nm, multimode
	7F	Channel 1 - G.703; Channel 2 - 1300 nm, multimode
	7G	Channel 1 - G.703; Channel 2 - 1300 nm, single-mode ELED
7H	820 nm, multimode, LED, 2 Channels	
7I	1300 nm, multimode, LED, 2 Channels	
7J	1300 nm, single-mode, ELED, 2 Channels	
7K	1300 nm, single-mode, Laser, 2 Channels	
7L	Channel 1 - RS422; Channel 2 - 820 nm, multimode, LED	
7M	Channel 1 - RS422; Channel 2 - 1300 nm, multimode, LED	
7N	Channel 1 - RS422; Channel 2 - 1300 nm, single-mode, ELED	
7P	Channel 1 - RS422; Channel 2 - 1300 nm, single-mode, Laser	
7Q	Channel 1 - G.703; Channel 2 - 1300 nm, single-mode Laser	
7R	G.703, 1 Channel	
7S	G.703, 2 Channels	
7T	RS422, 1 Channel	
7W	RS422, 2 Channels	
TRANSDUCER INPUTS/OUTPUTS	5A	4 DCmA inputs, 4 DCmA outputs (only one 5A or 5D module is allowed)
	5C	8 RTD inputs
	5D	4 RTD inputs, 4 DCmA outputs (only one 5A or 5D module is allowed)
	5E	4 DCmA inputs, 4 RTD inputs
	5F	8 DCmA inputs

Table 2-9: UR order codes for replacement modules, vertical units

	UR	-	**	-	*	
POWER SUPPLY	SH	B				125 / 300 V AC/DC
	SL	V				24 to 48 V (DC only)
CPU	T					RS485 with 3 100Base-FX Ethernet, multimode, SFP with LC
	U					RS485 with 1 100Base-TX Ethernet, SFP RJ-45 + 2 100Base-FX Ethernet, multimode, SFP with LC
	V					RS485 with 3 100Base-TX Ethernet, SFP with RJ-45
	W					RS485 with 2 100Base-FX Ethernet, multimode ST + 10/100Base-TX Ethernet, RJ-45
FRONT PANEL + INTERFACE	3F					Vertical front panel with keypad and English display
	3D					Vertical front panel with keypad and French display
	3R					Vertical front panel with keypad and Russian display
	3A					Vertical front panel with keypad and Chinese display
	3K					Enhanced front panel with English display
	3M					Enhanced front panel with French display
	3Q					Enhanced front panel with Russian display
	3U					Enhanced front panel with Chinese display
	3L					Enhanced front panel with English display and user-programmable pushbuttons
	3N					Enhanced front panel with French display and user-programmable pushbuttons
	3T					Enhanced front panel with Russian display and user-programmable pushbuttons
	3V					Enhanced front panel with Chinese display and user-programmable pushbuttons
	3I					Enhanced front panel with German display
	3J					Enhanced front panel with German display and user-programmable pushbuttons
CONTACT INPUTS/OUTPUTS	4A					4 Solid-State (no monitoring) MOSFET outputs
	4B					4 Solid-State (voltage with optional current) MOSFET outputs
	4C					4 Solid-State (current with optional voltage) MOSFET outputs
	4D					16 Contact inputs with Auto-Burnishing
	4L					14 Form-A (no monitoring) Latching outputs
	67					8 Form-A (no monitoring) outputs
	6A					2 Form-A (voltage with optional current) and 2 Form-C outputs, 8 contact inputs
	6B					2 Form-A (voltage with optional current) and 4 Form-C outputs, 4 contact inputs
	6C					8 Form-C outputs
	6D					16 Contact inputs
	6E					4 Form-C outputs, 8 contact inputs
	6F					8 Fast Form-C outputs
	6G					4 Form-A (voltage with optional current) outputs, 8 contact inputs
	6H					6 Form-A (voltage with optional current) outputs, 4 contact inputs
	6K					4 Form-C and 4 Fast Form-C outputs
	6L					2 Form-A (current with optional voltage) and 2 Form-C outputs, 8 contact inputs
	6M					2 Form-A (current with optional voltage) and 4 Form-C outputs, 4 contact inputs
	6N					4 Form-A (current with optional voltage) outputs, 8 contact inputs
	6P					6 Form-A (current with optional voltage) outputs, 4 contact inputs
	6R					2 Form-A (no monitoring) and 2 Form-C outputs, 8 contact inputs
	6S					2 Form-A (no monitoring) and 4 Form-C outputs, 4 contact inputs
	6T					4 Form-A (no monitoring) outputs, 8 contact inputs
	6U					6 Form-A (no monitoring) outputs, 4 contact inputs
	6V					2 Form-A outputs, 1 Form-C output, 2 Form-A (no monitoring) latching outputs, 8 contact inputs
	6W					30 Contact inputs - pin terminals (max 4 modules)
	6X					18 Form-A (no monitoring) outputs - pin terminals (max 4 modules)
CT/VT MODULES (not available for the C30)	8L					Standard 4CT/4VT with enhanced diagnostics
	8N					Standard 8CT with enhanced diagnostics
	8M					Sensitive Ground 4CT/4VT with enhanced diagnostics
	8R					Sensitive Ground 8CT with enhanced diagnostics
INTER-RELAY COMMUNICATIONS	2A					C37.94SM, 1300 nm single-mode, ELED, 1 channel single-mode
	2B					C37.94SM, 1300 nm single-mode, ELED, 2 channel single-mode
	2E					Bi-phase, single channel
	2F					Bi-phase, dual channel
	2G					IEEE C37.94, 820 nm, 128 kbps, multimode, LED, 1 Channel
	2H					IEEE C37.94, 820 nm, 128 kbps, multimode, LED, 2 Channels
	2I					Channel 1 - IEEE C37.94, multimode, 64/128 kbps; Channel 2 - 1300 nm, single-mode, Laser
	2J					Channel 1 - IEEE C37.94, multimode, 64/128 kbps; Channel 2 - 1550 nm, single-mode, Laser
	72					1550 nm, single-mode, Laser, 1 Channel
	73					1550 nm, single-mode, Laser, 2 Channel
	74					Channel 1 - RS422; Channel 2 - 1550 nm, single-mode, Laser
	75					Channel 1 - G.703; Channel 2 - 1550 nm, single-mode Laser
	76					IEEE C37.94, 820 nm, 64 kbps, multimode, LED, 1 Channel
	77					IEEE C37.94, 820 nm, 64 kbps, multimode, LED, 2 Channels
	7A					820 nm, multimode, LED, 1 Channel
	7B					1300 nm, multimode, LED, 1 Channel
	7C					1300 nm, single-mode, ELED, 1 Channel
	7D					1300 nm, single-mode, Laser, 1 Channel
	7E					Channel 1 - G.703; Channel 2 - 820 nm, multimode
	7F					Channel 1 - G.703; Channel 2 - 1300 nm, multimode
	7G					Channel 1 - G.703; Channel 2 - 1300 nm, single-mode ELED
	7H					820 nm, multimode, LED, 2 Channels
	7I					1300 nm, multimode, LED, 2 Channels
	7J					1300 nm, single-mode, ELED, 2 Channels
	7K					1300 nm, single-mode, Laser, 2 Channels
	7L					Channel 1 - RS422; Channel 2 - 820 nm, multimode, LED
	7M					Channel 1 - RS422; Channel 2 - 1300 nm, multimode, LED
	7N					Channel 1 - RS422; Channel 2 - 1300 nm, single-mode, ELED
	7P					Channel 1 - RS422; Channel 2 - 1300 nm, single-mode, Laser
	7Q					Channel 1 - G.703; Channel 2 - 1300 nm, single-mode Laser
	7R					G.703, 1 Channel
	7S					G.703, 2 Channels
	7T					RS422, 1 Channel
	7V					RS422, 2 Channels
TRANSDUCER INPUTS/OUTPUTS	5A					4 DCmA inputs, 4 DCmA outputs (only one 5A or 5D module is allowed)
	5C					8 RTD inputs
	5D					4 RTD inputs, 4 DCmA outputs (only one 5A or 5D module is allowed)
	5E					4 DCmA inputs, 4 RTD inputs
	5F					8 DCmA inputs



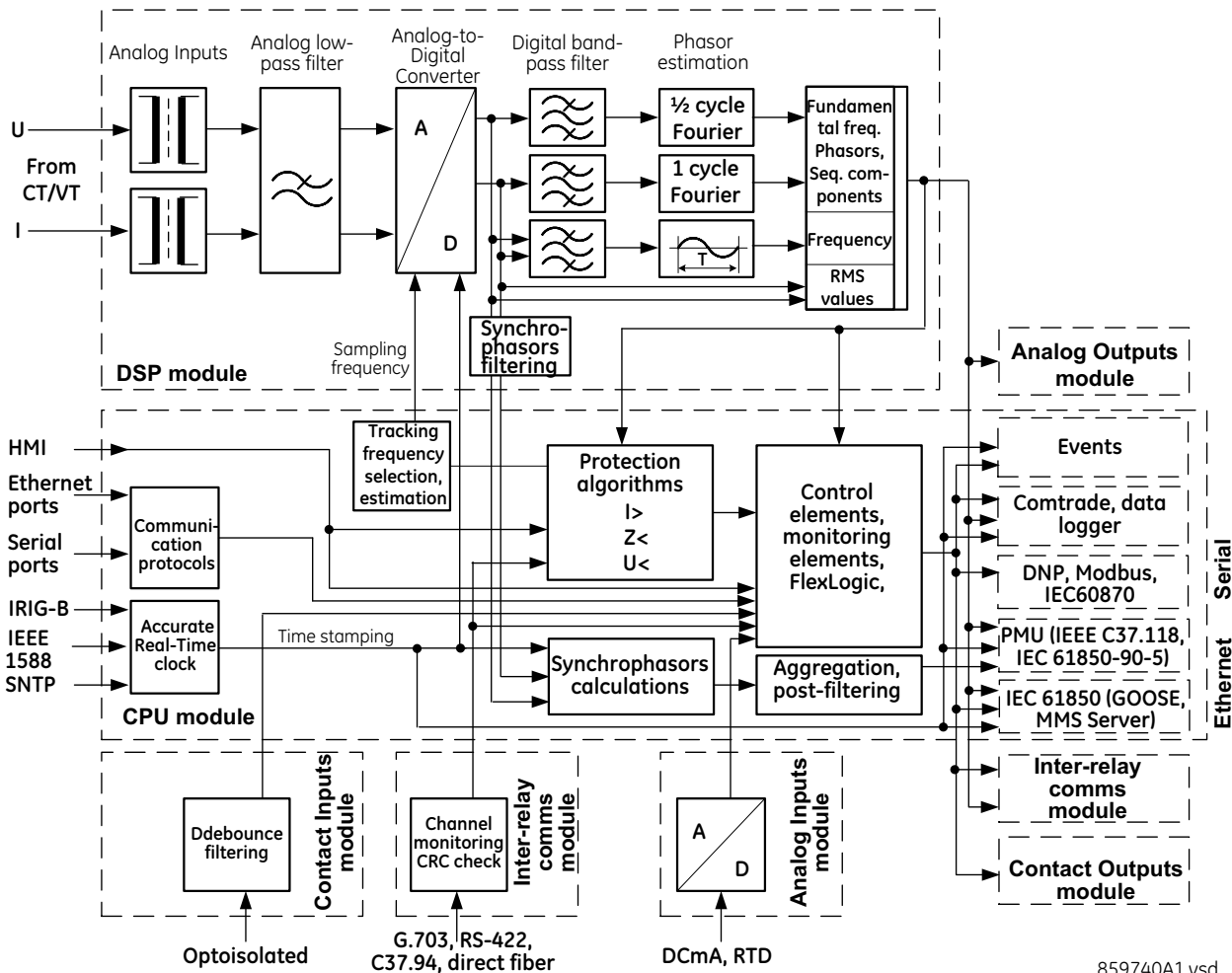
## 2.4 Signal processing

### 2.4.1 UR signal processing

The URs are microprocessor-based protective relays that are designed to measure power system conditions directly via CT and VT inputs and via other sources of information, such as analog inputs, communications inputs, and contact inputs. The following figure shows the overall signal processing in URs.

An analog low pass anti-aliasing filter with a 3 dB corner frequency is set at 2.4 kHz and is used for current and voltage analog filtering as well as signal conditioning. The same filtering is applied for phase, ground currents, phase-to-phase (when applicable), and auxiliary voltages. The 2.4 kHz cut-off frequency applies to both 50 and 60 Hz applications and fixed in the hardware, and thus is not dependent on the system nominal frequency setting.

Figure 2-6: UR signal processing



The UR samples its AC signals at 64 samples per cycle, that is, at 3840 Hz in 60 Hz systems, and 3200 Hz in 50 Hz systems. The sampling rate is adjusted dynamically to the actual system frequency by an accurate and fast frequency tracking system.

The analog/digital converter has the following ranges of AC signals:

Voltages:

$$\pm\sqrt{2} \cdot 260(\text{V}) \quad \text{Eq. 2-1}$$

Currents:

$$\pm\sqrt{2} \cdot 46\text{rated}(\text{A}) \quad \text{Eq. 2-2}$$

Current harmonics are estimated based on raw samples with the use of the full-cycle Fourier filter. Harmonics 2nd through 25th are estimated.

True RMS value for the current is calculated on a per-phase basis. The true RMS can be used for demand recording or as an input signal to Time Overcurrent function, if the latter is intended for thermal protection. The true RMS is calculated as per the widely accepted definition:

$$I_{\text{RMS}(t)} = \sqrt{\frac{1}{T} \int_{(t-T)}^t i^2(t) dt} \quad \text{Eq. 2-3}$$

RMS values include harmonics, inter-harmonics, DC components, and so on, along with fundamental frequency values. The true RMS value reflects thermal effects of the current and is used for the thermal related monitoring and protection functions.

Protection and control functions respond to phasors of the fundamental and/or harmonic frequency components (magnitudes and angles), with an exception for some functions that have an option for RMS or fundamental measurements, or some function responding to RMS only. This type of response is explained typically in each element's section in this instruction manual.

Currents are pre-filtered using a Finite Impulse Response (FIR) digital filter. The filter is designed to reject DC components and low-frequency distortions, without amplifying high-frequency noise. This filter is referred to as a modified MIMIC filter, which provides excellent filtering and overall balance between speed and accuracy of filtering. The filter is cascaded with the full-cycle Fourier filter for the current phasor estimation.

Voltages are pre-filtered using a patented FIR digital filter. The filter has been optimized to reject voltage-transformer-specific distortions, such as Capacitive Voltage Transformer (CVT) noise and high-frequency oscillatory components. The filter is cascaded with the half-cycle Fourier filter for the voltage phasor estimation.

The URs measure power system frequency using the Clarke transformation by estimating the period of the waveform from two consecutive zero-crossings in the same direction (negative-to-positive). Voltage or current samples are pre-filtered using a Finite Impulse Response (FIR) digital filter to remove high frequency noise contained in the signal. The period is used after several security conditions are met, such as true RMS signal must be above 6% nominal for a certain time. If these security conditions are not met, the last valid measurement is used for a specific time after which the UR reverts to nominal system frequency.

Synchrophasors are calculated using a patented convolution integral algorithm. This algorithm allows use of the same time-stamped samples, which are used for protection and taken at the same sampling frequency. This allows URs to use one sampling clock for both protection algorithms and synchrophasors.

Synchrophasors on firmware versions 7.23 and up have been tested and certified to meet IEEE C37.118-2011 and C37.118.1a-2014 standards for both metering and protection classes with outputs available up to 60 synchrophasors per second for the metering class and 120 synchrophasors per second for the protection class. Synchrophasors measurement is also available via IEC 61850-90-5 protocol.

The contact inputs threshold is settable in the firmware with 17, 33, 84, and 166 V DC settings available. Inputs are scanned every 0.5 ms and can be conditioned for the critical applications, using debounce time timer, settable from 0.0 to 16.0 ms. Contact inputs with auto-burnishing are available as well, when external contacts are exposed to the contamination in a harsh industrial environment.

All measured values are available in the UR metering section on the front panel and via communications protocols. Measured analog values and binary signals can be captured in COMTRADE format with sampling rates from 8 to 64 samples per power cycle. Analog values can be captured with the Data Logger, allowing much slower rates extended over a long period of time.

Other advanced UR order code options are available to support IEC 61850 (including fast GOOSE, ICD/CID/IID files, and so on), IEEE 1588 (IEEE C37.238 power profile) based time synchronization, CyberSentry (advanced cyber security), the Parallel Redundancy Protocol (PRP), IEC 60870-5-103, and so on.

## 2.5 Specifications

Specifications are subject to change without notice.

### 2.5.1 Protection elements

The operating times include the activation time of a trip rated form-A output contact unless otherwise indicated. FlexLogic operands of a given element are 4 ms faster. Take this into account when using FlexLogic to interconnect with other protection or control elements of the relay, building FlexLogic equations, or interfacing with other intelligent electronic devices (IEDs) or power system devices via communications or different output contacts. If not specified, the operate times given here are for a 60 Hz system at nominal system frequency. Operate times for a 50 Hz system are 1.2 times longer.

#### PERCENT DIFFERENTIAL

Characteristic:	Differential restraint pre-set
Number of zones:	1
Minimum pickup:	0.05 to 1.00 pu in steps of 0.001
Slope 1 range:	15 to 100% in steps of 1%
Slope 2 range:	50 to 100% in steps of 1%
Kneepoint 1:	1.0 to 2.0 pu in steps of 0.001
Kneepoint 2:	2.0 to 30.0 pu in steps of 0.001
2 <sup>nd</sup> harmonic inhibit level:	1.0 to 40.0% in steps of 0.1
2 <sup>nd</sup> harmonic inhibit function:	Adaptive, Traditional, Disabled
2 <sup>nd</sup> harmonic inhibit mode:	Per-phase, 2-out-of-3, Average, 1-out-of-3
5 <sup>th</sup> harmonic inhibit range:	1.0 to 40.0% in steps of 0.1
Operate times:	
Harmonic inhibits selected:	20 to 30 ms at 60 Hz; 20 to 35 ms at 50 Hz
No harmonic inhibits selected:	5 to 20 ms
Dropout level:	97 to 98% of pickup
Level accuracy:	±0.5% of reading or ±1% of rated (whichever is greater) for two windings setup

#### RESTRICTED GROUND FAULT

Pickup:	0.005 to 30.000 pu in steps of 0.001
Dropout:	97 to 98% of pickup
Slope:	0 to 100% in steps of 1%
Level accuracy:	
0.1 to 2.0 × CT rating:	±0.5% of reading or ±1% of rated (whichever is greater)
>2.0 × CT rating	±1.5% of reading
Pickup delay:	0 to 600.00 s in steps of 0.01
Dropout delay:	0 to 600.00 s in steps of 0.01
Operate time:	<1 power system cycle

#### PHASE/NEUTRAL/GROUND TOC

Current:	Phasor or RMS
Pickup level:	0.020 to 30.000 pu in steps of 0.001
Dropout level:	97% to 98% of pickup
Level accuracy:	
0.1 to 2.0 × CT:	±0.5% of reading or ±0.4% of rated (whichever is greater)
> 2.0 × CT:	±1.5% of reading > 2.0 × CT rating

Curve shapes:	IEEE Moderately/Very/Extremely Inverse; IEC (and BS) A/B/C and Short Inverse; GE IAC Inverse, Short/Very/Extremely Inverse; I <sup>2</sup> t; FlexCurves™ (programmable); Definite Time (0.01 s base curve)
Curve multiplier:	Time Dial = 0.00 to 600.00 in steps of 0.01
Reset type:	Instantaneous/Timed (per IEEE)
Curve timing accuracy at 1.03 to 20 × pickup:	±3.5% of operate time or ±½ cycle (whichever is greater) from pickup to operate
Voltage restraint:	Modifies pickup current for voltage in the range of 0.1 < V < 0.9 VT Nominal in a fixed linear relationship

**PHASE/NEUTRAL/GROUND IOC**

Pickup level:	0.020 to 30.000 pu in steps of 0.001
Dropout level:	97 to 98% of pickup
Level accuracy:	
0.1 to 2.0 × CT rating:	±0.5% of reading or ±0.4% of rated (whichever is greater)
> 2.0 × CT rating:	±1.5% of reading
Overreach:	<2%
Pickup delay:	0.00 to 600.00 s in steps of 0.01
Reset delay:	0.00 to 600.00 s in steps of 0.01
Operate time:	<16 ms at 3 × pickup at 60 Hz (Phase/Ground IOC) <20 ms at 3 × pickup at 60 Hz (Neutral IOC)
Timer accuracy:	±3% of operate time or ±1/4 cycle (whichever is greater)

**PHASE DIRECTIONAL OVERCURRENT**

Relay connection:	90° (quadrature)
Quadrature voltage:	ABC phase seq.: phase A (V <sub>BC</sub> ), phase B (V <sub>CA</sub> ), phase C (V <sub>AB</sub> ); ACB phase seq.: phase A (V <sub>CB</sub> ), phase B (V <sub>AC</sub> ), phase C (V <sub>BA</sub> )
Polarizing voltage threshold:	0.004 to 3.000 pu in steps of 0.001
Current sensitivity threshold:	0.05 pu
Characteristic angle:	0 to 359° in steps of 1
Angle accuracy:	±2°
Operation time (FlexLogic operands):	
Tripping (reverse load, forward fault):	<12 ms, typically
Blocking (forward load, reverse fault):	<8 ms, typically

**NEUTRAL DIRECTIONAL OVERCURRENT**

Directionality:	Co-existing forward and reverse
Polarizing:	Voltage, Current, Dual, Dual-V, Dual-I
Polarizing voltage:	V <sub>0</sub> or VX
Polarizing current:	I <sub>G</sub>
Operating current:	I <sub>0</sub>
Level sensing:	3 × ( I <sub>0</sub>   - K ×  I <sub>1</sub>  ), I <sub>G</sub>
Restraint, K:	0.000 to 0.500 in steps of 0.001
Characteristic angle:	-90 to 90° in steps of 1
Limit angle:	40 to 90° in steps of 1, independent for forward and reverse
Angle accuracy:	±2°
Offset impedance:	0.00 to 250.00 Ω in steps of 0.01
Pickup level:	0.002 to 30.000 pu in steps of 0.01
Dropout level:	97 to 98%
Operation time:	<16 ms at 3 × pickup at 60 Hz

**NEGATIVE SEQUENCE DIRECTIONAL OC**

Directionality:	Co-existing forward and reverse
Polarizing:	Voltage
Polarizing voltage:	V <sub>2</sub>
Operating current:	I <sub>2</sub>
Level sensing:	
Zero-sequence:	I <sub>0</sub>   - K ×  I <sub>1</sub>



Negative-sequence:	$ I_{-2}  - K \times  I_{-1} $
Restraint, K:	0.000 to 0.500 in steps of 0.001
Characteristic angle:	0 to 90° in steps of 1
Limit angle:	40 to 90° in steps of 1, independent for forward and reverse
Angle accuracy:	$\pm 2^\circ$
Offset impedance:	0.00 to 250.00 $\Omega$ in steps of 0.01
Pickup level:	0.015 to 30.000 pu in steps of 0.01
Dropout level:	97 to 98%
Operation time:	<16 ms at 3 × pickup at 60 Hz

**GENERATOR UNBALANCE**

Gen. nominal current:	0.000 to 1.250 pu in steps of 0.001
Stages:	2 ( $I^2t$ with linear reset and definite time)
Pickup level:	0.00 to 100.00% in steps of 0.01
Dropout level:	97 to 98% of pickup
Level accuracy:	
0.1 to 2 × CT rating:	$\pm 0.5\%$ of reading or 1% of rated (whichever is greater)
> 2.0 × CT rating:	$\pm 1.5\%$ of reading
Time dial (K-value):	0.00 to 100.00 in steps of 0.01
Pickup delay:	0.0 to 1000.0 s in steps of 0.1
Reset delay:	0.0 to 1000.0 s in steps of 0.1
Timer accuracy:	$\pm 3\%$ of operate time or $\pm 20$ ms, whichever is greater
Operate time:	<50 ms at 60 Hz

**SPLIT PHASE PROTECTION**

Operating quantity:	split phase CT current biased by generator load current
Pickup level:	0.020 to 1.500 pu in steps of 0.001
Dropout level:	97 to 98% of pickup
Level accuracy:	$\pm 0.5\%$ of reading or $\pm 1\%$ of rated
Pickup delay:	0.000 to 65.535 s in steps of 0.001
Timer accuracy:	$\pm 3\%$ of operate time or $\pm 5$ cycles, whichever is greater
Operate time:	<5 cycles at 1.10 × pickup at 60 Hz

**SENSITIVE DIRECTIONAL POWER**

Measured power:	3-phase, true RMS
Number of stages:	2
Characteristic angle:	0 to 359° in steps of 1
Calibration angle:	0.00 to 0.95° in steps of 0.05
Minimum power:	-1.200 to 1.200 pu in steps of 0.001
Pickup level accuracy:	$\pm 1\%$ or $\pm 0.001$ pu, whichever is greater
Hysteresis:	2% or 0.001 pu, whichever is greater
Pickup delay:	0 to 600.00 s in steps of 0.01
Timer accuracy:	$\pm 3\%$ of operate time or $\pm 1/4$ cycle (whichever is greater)
Operate time:	<50 ms

**PHASE UNDERVOLTAGE**

Pickup level:	0.004 to 3.000 pu in steps of 0.001
Dropout level:	102 to 103% of pickup
Level accuracy:	$\pm 0.5\%$ of reading from 10 to 208 V
Curve shapes:	GE IAV Inverse; Definite Time (0.1 s base curve)
Curve multiplier:	Time dial = 0.00 to 600.00 in steps of 0.01
Curve timing accuracy at <0.90 × pickup:	$\pm 3.5\%$ of operate time or $\pm 1/2$ cycle (whichever is greater) from pickup to operate
Operate time:	<30 ms at 0.9 pickup at 60 Hz for Definite Time mode

**AUXILIARY UNDERVOLTAGE**

Pickup level:	0.004 to 3.000 pu in steps of 0.001
---------------	-------------------------------------



Dropout level:	102 to 103% of pickup
Level accuracy:	±0.5% of reading from 10 to 208 V
Curve shapes:	GE IAV Inverse, Definite Time
Curve multiplier:	Time Dial = 0 to 600.00 in steps of 0.01
Curve timing accuracy at <math>0.90 \times \text{pickup}</math>:	±3.5% of operate time or ±1/2 cycle (whichever is greater) from pickup to operate
Operate time:	<math><30 \text{ ms}</math> at 0.9 pickup at 60 Hz for Definite Time mode

### THIRD HARMONIC NEUTRAL UNDERVOLTAGE

Operating quantity:	3rd harmonic of auxiliary undervoltage
Undervoltage:	
Pickup level:	0.0010 to 3.0000 pu in steps of 0.0001
Dropout level:	102 to 103% of pickup
Accuracy:	±2% of reading from 1 to 120 V
Power:	
Pickup level:	0.000 to 1.250 pu in steps of 0.001
Dropout level:	97 to 98% of pickup
Accuracy:	±5% or ±0.01 pu, whichever is greater
Undervoltage Inhibit	
Level:	0.000 to 1.250 pu in steps of 0.001 pu
Accuracy:	±0.5% of reading from 10 to 208 V
Pickup delay:	0 to 600.00 s in steps of 0.01
Timer accuracy:	±3% of operate time or ±20 ms, whichever is greater
Operate time:	<math><30 \text{ ms}</math> at 0.9 × pickup at 60 Hz

### PHASE OVERVOLTAGE

Voltage:	Phasor only
Pickup level:	0.004 to 3.000 pu in steps of 0.001
Dropout level:	97 to 98% of pickup
Level accuracy:	±0.5% of reading from 10 to 208 V
Pickup delay:	0.00 to 600.00 in steps of 0.01 s
Operate time:	<math><30 \text{ ms}</math> at 1.10 × pickup at 60 Hz
Timer accuracy:	±3% of operate time or ±1/4 cycle (whichever is greater)

### NEUTRAL OVERVOLTAGE

Pickup level:	0.004 to 3.000 pu in steps of 0.001
Dropout level:	97 to 98% of pickup
Level accuracy:	±0.5% of reading from 10 to 208 V
Pickup delay:	0.00 to 600.00 s in steps of 0.01 (definite time) or user-defined curve
Reset delay:	0.00 to 600.00 s in steps of 0.01
Curve timing accuracy at >1.1 pickup:	±3.5% of operate time or ±1 cycle (whichever is greater) from pickup to operate
Operate time:	<math><30 \text{ ms}</math> at 1.10 pickup at 60 Hz

### AUXILIARY OVERVOLTAGE

Pickup level:	0.004 to 3.000 pu in steps of 0.001
Dropout level:	97 to 98% of pickup
Level accuracy:	±0.5% of reading from 10 to 208 V
Pickup delay:	0 to 600.00 s in steps of 0.01
Reset delay:	0 to 600.00 s in steps of 0.01
Timer accuracy:	±3% of operate time or ±1/4 cycle (whichever is greater)
Operate time:	<math><30 \text{ ms}</math> at 1.10 × pickup at 60 Hz

### NEGATIVE SEQUENCE OVERVOLTAGE

Pickup level:	0.004 to 1.250 pu in steps of 0.001
Dropout level:	97 to 98% of pickup
Level accuracy:	±0.5% of reading from 10 to 208 V
Pickup delay:	0 to 600.00 s in steps of 0.01

Reset delay:	0 to 600.00 s in steps of 0.01
Timer accuracy:	±3% of operate time or ±20 ms, whichever is greater
Operate time:	<30 ms at 1.10 × pickup at 60 Hz

**VOLTS PER HERTZ**

Voltage:	Phasor only
Pickup level:	0.80 to 4.00 in steps of 0.01 pu V/Hz
Dropout level:	97 to 98% of pickup
Level accuracy:	±0.02 pu
Pickup delay:	0 to 600.00 s in steps of 0.01
Timing curves:	Definite Time; Inverse A, B, and C, FlexCurves™ A, B, C, and D
TD Multiplier:	0.05 to 600.00 s in steps of 0.01
Reset delay:	0.0 to 1000.0 s in steps of 0.1
Timer accuracy:	±3% of operate time or ±3 cycles (whichever is greater) for values greater than 1.1 × pickup

**TRANSFORMER HOTTEST-SPOT TEMPERATURE**

Operating quantity:	computed temperature in °C
Pickup level:	50 to 300°C in steps of 1
Dropout level:	1°C below pickup
Pickup delay:	0 to 30000 min. in steps of 1

**TRANSFORMER AGING FACTOR**

Operating quantity:	computed aging acceleration factor (pu)
Pickup level:	1 to 10 pu in steps of 0.1
Pickup delay:	0 to 30000 min. in steps of 1

**TRANSFORMER LOSS OF LIFE**

Operating quantity:	computed accumulated transformer loss of life, in hours
Pickup level:	0 to 500000 hours in steps of 1

**UNDERFREQUENCY**

Minimum signal:	0.10 to 1.25 pu in steps of 0.01
Pickup level:	20.00 to 65.00 Hz in steps of 0.01
Dropout level:	pickup + 0.03 Hz
Level accuracy:	±0.001 Hz
Time delay:	0 to 65.535 s in steps of 0.001
Timer accuracy:	±3% of operate time or ±1/4 cycle (whichever is greater)
Operate time:	typically 4 cycles at 0.1 Hz/s change typically 3.5 cycles at 0.3 Hz/s change typically 3 cycles at 0.5 Hz/s change

Typical times are average operate times including variables, such as frequency change instance, and test method, and can vary by ±0.5 cycles.

**OVERFREQUENCY**

Pickup level:	20.00 to 65.00 Hz in steps of 0.01
Dropout level:	pickup – 0.03 Hz
Level accuracy:	±0.001 Hz
Time delay:	0 to 65.535 s in steps of 0.001
Timer accuracy:	±3% of operate time or ±1/4 cycle (whichever is greater)
Operate time:	typically 4 cycles at 0.1 Hz/s change typically 3.5 cycles at 0.3 Hz/s change typically 3 cycles at 0.5 Hz/s change

Typical times are average operate times including variables such as frequency change instance, test method, and so on, and can vary by ±0.5 cycles.

**RATE OF CHANGE OF FREQUENCY**

df/dt trend:	increasing, decreasing, bi-directional
df/dt pickup level:	0.10 to 15.00 Hz/s in steps of 0.01

df/dt dropout level:	96% of pickup
df/dt level accuracy:	80 mHz/s or 3.5%, whichever is greater
Overvoltage supv.:	0.100 to 3.000 pu in steps of 0.001
Overcurrent supv.:	0.020 to 30.000 pu in steps of 0.001
Pickup delay:	0 to 65.535 s in steps of 0.001
Reset delay:	0 to 65.535 s in steps of 0.001
Timer accuracy:	±3% of operate time or ±1/4 cycle (whichever is greater)
95% settling time for df/dt:	<24 cycles
Operate time:	typically 9.5 cycles at 2 × pickup typically 8.5 cycles at 3 × pickup typically 6.5 cycles at 5 × pickup

Typical times are average operate times including variables such as frequency change instance, test method, and so on, and can vary by ±0.5 cycles.

### TURBINE FREQUENCY OUT-OF-BAND (OOB) ACCUMULATED OPERATING TIME

Frequency OOB accumulation:	7 sets; 20 to 70 Hz in steps of 0.01
Frequency OOB accumulation pickup:	1 to 65536 s in steps of 1
Frequency OOB accumulator preset:	1 to 65536 s in steps of 1
Level accuracy:	±0.01 Hz
Minimum volt/amp supervision:	0.1 to 1.25 pu of V <sub>1</sub> or I <sub>1</sub>
Timer accuracy of accumulation:	±1% or 1 second, whichever is greater

### BREAKER ARCING CURRENT

Principle:	accumulates breaker duty ( $I^2t$ ) and measures fault duration
Initiation:	programmable per phase from any FlexLogic operand
Compensation for auxiliary relays:	0 to 65.535 s in steps of 0.001
Alarm threshold:	0 to 50000 kA <sup>2</sup> -cycle in steps of 1
Fault duration accuracy:	0.25 of a power cycle
Availability:	1 per CT bank with a minimum of 2

### SYNCHROCHECK

Max voltage difference:	0 to 400000 V in steps of 1
Max angle difference:	0 to 100° in steps of 1
Max freq. difference:	0.00 to 2.00 Hz in steps of 0.01
Hysteresis for max. freq. diff.:	0.00 to 0.10 Hz in steps of 0.01
Dead source function:	None, LV1 & DV2, DV1 & LV2, DV1 or DV2, DV1 xor DV2, DV1 & DV2 (L = Live, D = Dead)
S-CLS MAX dF:	0.10 to 2.00 Hz in steps of 0.01
S-CLS MIN dF:	0.00 to 1.00 Hz in steps of 0.01
V2 MAG CORR FACTOR:	0.10 to 10.00 in steps of 0.01
V2 ANGLE SHIFT:	-180° to +180° in steps of 1°

### ACCIDENTAL ENERGIZATION

Operating condition:	Overcurrent
Arming condition:	Undervoltage and/or Machine Offline
Overcurrent:	
Pickup level:	0.020 to 3.000 pu in steps of 0.001
Dropout level:	97 to 98% of pickup
Level accuracy:	±0.5% of reading from 0.1 to 2.0 × CT rating
Undervoltage:	
Pickup level:	0.004 to 3.000 pu in steps of 0.001
Dropout level:	102 to 103% of pickup
Level accuracy:	±0.5% of reading 10 to 208 V
Operate Time:	<30 ms at 1.10 × pickup at 60 Hz

### LOSS OF EXCITATION

Operating condition:	Positive-sequence impedance
Characteristic:	2 independent offset mho circles

Center:	0.10 to 300.0 $\Omega$ (sec.) in steps of 0.01
Radius:	0.10 to 300.0 $\Omega$ (sec.) in steps of 0.01
Reach accuracy:	$\pm 3\%$
Undervoltage supervision	
Level:	0.000 to 1.250 pu in steps of 0.001
Accuracy:	$\pm 0.5\%$ of reading from 10 to 208 V
Pickup delay:	0 to 65.535 s in steps of 0.001
Timer accuracy:	$\pm 3\%$ of operate time or $\pm 20$ ms, whichever is greater
Operate time:	<50 ms

### THERMAL OVERLOAD PROTECTION

Thermal overload curves:	IEC 255-8 curve
Base current:	0.20 to 3.00 pu in steps of 0.01
Overload (k) factor:	1.00 to 1.20 pu in steps of 0.05
Trip time constant:	0 to 1000 min. in steps of 1
Reset time constant:	0 to 1000 min. in steps of 1
Minimum reset time:	0 to 1000 min. in steps of 1
Timer accuracy (cold curve):	$\pm 100$ ms or 2%, whichever is greater
Timer accuracy (hot curve):	$\pm 500$ ms or 2%, whichever is greater for $I_p < 0.9 \times k \times I_b$ and $I / (k \times I_b) > 1.1$

### TRIP BUS (TRIP WITHOUT FLEXLOGIC)

Number of elements:	6
Number of inputs:	16
Operate time:	<2 ms at 60 Hz
Timer accuracy:	$\pm 3\%$ or 10 ms, whichever is greater

## 2.5.2 User-programmable elements

### FLEXLOGIC

Programming language:	Reverse Polish Notation with graphical visualization (keypad programmable)
Lines of code:	1024
Internal variables:	64
Supported operations:	NOT, XOR, OR (2 to 16 inputs), AND (2 to 16 inputs), NOR (2 to 16 inputs), NAND (2 to 16 inputs), latch (reset-dominant), edge detectors, timers
Inputs:	any logical variable, contact, or virtual input
Number of timers:	32
Pickup delay:	0 to 60000 (ms, sec., min.) in steps of 1
Dropout delay:	0 to 60000 (ms, sec., min.) in steps of 1

### FLEXCURVES™

Number:	4 (A through D)
Reset points:	40 (0 through 1 of pickup)
Operate points:	80 (1 through 20 of pickup)
Time delay:	0 to 65535 ms in steps of 1

### FLEX STATES

Number:	up to 256 logical variables grouped under 16 Modbus addresses
Programmability:	any logical variable, contact, or virtual input

### FLEXELEMENTS™

Number of elements:	16
Operating signal:	any analog actual value, or two values in differential mode
Operating signal mode:	signed or absolute value
Operating mode:	level, delta
Comparator direction:	over, under
Pickup Level:	-90.000 to 90.000 pu in steps of 0.001

Hysteresis:	0.1 to 50.0% in steps of 0.1
Delta dt:	20 ms to 60 days
Pickup and dropout delay:	0.000 to 65.535 s in steps of 0.001

**NON-VOLATILE LATCHES**

Type:	set-dominant or reset-dominant
Number:	16 (individually programmed)
Output:	stored in non-volatile memory
Execution sequence:	as input prior to protection, control, and FlexLogic

**USER-PROGRAMMABLE LEDs (Enhanced and basic front panels)**

Number:	48 plus trip and alarm
Programmability:	from any logical variable, contact, or virtual input
Reset mode:	self-reset or latched

**LED TEST**

Initiation:	from any contact input or user-programmable condition
Number of tests:	3, interruptible at any time
Duration of full test:	approximately 3 minutes
Test sequence 1:	all LEDs on
Test sequence 2:	all LEDs off, one LED at a time on for 1 s
Test sequence 3:	all LEDs on, one LED at a time off for 1 s

**USER-DEFINABLE DISPLAYS (Enhanced and basic front panels)**

Number of displays:	16
Lines of display:	2 × 20 alphanumeric characters
Parameters:	up to 5, any Modbus register addresses
Invoking and scrolling:	keypad, or any user-programmable condition, including pushbuttons

**CONTROL PUSHBUTTONS (Enhanced and basic front panels)**

Number of pushbuttons:	7
Operation:	drive FlexLogic operands

**USER-PROGRAMMABLE PUSHBUTTONS (Optional)**

Number of pushbuttons:	12 on basic front panel 16 on enhanced horizontal front panel 6 on enhanced vertical front panel 16 on graphical front panel (8 physical pushbuttons, 8 graphical interface pushbuttons)
Mode:	self-reset, latched
Display message:	2 lines of 20 characters each
Drop-out timer:	0.00 to 60.00 s in steps of 0.05
Autoreset timer:	0.2 to 600.0 s in steps of 0.1
Hold timer:	0.0 to 10.0 s in steps of 0.1

**SELECTOR SWITCH**

Number of elements:	2
Upper position limit:	1 to 7 in steps of 1
Selecting mode:	time-out or acknowledge
Time-out timer:	3.0 to 60.0 s in steps of 0.1
Control inputs:	step-up and 3-bit
Power-up mode:	restore from non-volatile memory or synchronize to a 3-bit control input or synch/restore mode

**DIGITAL ELEMENTS**

Number of elements:	48
Operating signal:	any FlexLogic operand
Pickup delay:	0.000 to 999999.999 s in steps of 0.001
Dropout delay:	0.000 to 999999.999 s in steps of 0.001
Timing accuracy:	±3% or ±4 ms, whichever is greater

## 2.5.3 Monitoring

### OSCILLOGRAPHY

Maximum records:	64
Sampling rate:	64 samples per power cycle
Triggers:	any element pickup, dropout, or operate; contact input change of state; contact output change of state; FlexLogic equation
Data:	AC input channels; element state; contact input state; contact output state
Data storage:	in non-volatile memory

### EVENT RECORDER

Capacity:	1024 events
Time-tag:	to 1 microsecond
Triggers:	any element pickup, dropout, or operate; contact input change of state; contact output change of state; self-test events
Data storage:	in non-volatile memory

### USER-PROGRAMMABLE FAULT REPORT

Number of elements:	2
Pre-fault trigger:	any FlexLogic operand
Fault trigger:	any FlexLogic operand
Recorder quantities:	32 (any FlexAnalog™ value)

### DATA LOGGER

Number of channels:	1 to 16
Parameters:	any available analog actual value
Sampling rate:	15 to 3600000 ms in steps of 1
Trigger:	any FlexLogic operand
Mode:	continuous or triggered
Storage capacity:	(NN is dependent on memory)
	1-second rate:
	01 channel for NN days
	16 channels for NN days
	↓
	60-minute rate:
	01 channel for NN days
	16 channels for NN days

## 2.5.4 Metering

### RMS CURRENT: PHASE, NEUTRAL, AND GROUND

Accuracy at	
0.1 to 2.0 × CT rating:	±0.25% of reading or ±0.1% of rated (whichever is greater)
> 2.0 × CT rating:	±1.0% of reading

### RMS VOLTAGE

Accuracy:	±0.5% of reading from 10 to 208 V
-----------	-----------------------------------

### REAL POWER (WATTS)

Accuracy at 0.1 to 1.5 × CT rating and 0.8 to 1.2 × VT rating:	±1.0% of reading at $-1.0 \leq PF < -0.8$ and $0.8 < PF \leq 10$
--	--

### REACTIVE POWER (VARs)

Accuracy at 0.1 to 1.5 × CT rating and 0.8 to 1.2 × VT rating:	±1.0% of reading at $-0.2 \leq PF \leq 0.2$
--	---

**APPARENT POWER (VA)**

Accuracy at 0.1 to 1.5 × CT rating and 0.8 to 1.2 × VT rating:  
±1.0% of reading

**WATT-HOURS (POSITIVE AND NEGATIVE)**

Accuracy: ±2.0% of reading  
Range: ±0 to 1 × 10<sup>6</sup> MWh  
Parameters: three-phase only  
Update rate: 50 ms

**VAR-HOURS (POSITIVE AND NEGATIVE)**

Accuracy: ±2.0% of reading  
Range: ±0 to 1 × 10<sup>6</sup> Mvarh  
Parameters: three-phase only  
Update rate: 50 ms

**CURRENT HARMONICS**

Harmonics: 2nd to 25th harmonic: per phase, displayed as a % of  $f_1$  (fundamental frequency phasor)  
THD: per phase, displayed as a % of  $f_1$

Accuracy:

**HARMONICS:** 1.  $f_1 > 0.4pu$ : (0.20% + 0.035% / harmonic) of reading or 0.15% of 100%, whichever is greater  
2.  $f_1 < 0.4pu$ : as above plus %error of  $f_1$

**THD:** 1.  $f_1 > 0.4pu$ : (0.25% + 0.035% / harmonic) of reading or 0.20% of 100%, whichever is greater  
2.  $f_1 < 0.4pu$ : as above plus %error of  $f_1$

**VOLTAGE HARMONICS**

Harmonics: 2nd to 25th harmonic: per phase, displayed as a % of  $f_1$  (fundamental frequency phasor)  
THD: per phase, displayed as a % of  $f_1$

Accuracy:

**HARMONICS:** 1.  $f_1 > 0.4pu$ : (0.20% + 0.035% / harmonic) of reading or 0.15% of 100%, whichever is greater  
2.  $f_1 < 0.4pu$ : as above plus %error of  $f_1$

**THD:** 1.  $f_1 > 0.4pu$ : (0.25% + 0.035% / harmonic) of reading or 0.20% of 100%, whichever is greater  
2.  $f_1 < 0.4pu$ : as above plus %error of  $f_1$

**FREQUENCY**

Accuracy at  
V = 0.8 to 1.2 pu: ±0.001 Hz (when voltage signal is used for frequency measurement)  
I = 0.1 to 0.25 pu: ±0.005 Hz  
I > 0.25 pu: ±0.02 Hz (when current signal is used for frequency measurement)

## 2.5.5 Inputs

**AC CURRENT**

CT rated primary: 1 to 50000 A  
CT rated secondary: 1 or 5 A by connection  
Relay burden: < 0.2 VA at rated secondary  
Conversion range:  
Standard CT: 0.02 to 46 × CT rating RMS symmetrical  
Sensitive Ground CT module: 0.002 to 4.6 × CT rating RMS symmetrical  
Current withstand:  
20 ms at 250 times rated  
1 sec at 100 times rated  
continuous 4×I<sub>nom</sub>  
Short circuit rating: 150000 RMS symmetrical amperes, 250 V maximum (primary current to external CT)

**AC VOLTAGE**

VT rated secondary: 50.0 to 240.0 V  
VT ratio: 1.00 to 24000.00

Relay burden:	< 0.25 VA at 120 V
Conversion range:	1 to 275 V
Voltage withstand:	continuous at 260 V to neutral 1 min/hr at 420 V to neutral

**FREQUENCY**

Nominal frequency setting:	25 to 60 Hz
Sampling frequency:	64 samples per power cycle
Tracking frequency range:	3 to 70 Hz

**CONTACT INPUTS**

Dry contacts:	1000 $\Omega$ maximum
Wet contacts:	300 V DC maximum
Selectable thresholds:	17 V, 33 V, 84 V, 166 V
Tolerance:	$\pm 10\%$
Contacts per common return:	4
Recognition time:	< 1 ms
Debounce time:	0.0 to 16.0 ms in steps of 0.5
Continuous current draw:	4 mA (when energized)

**CONTACT INPUTS WITH AUTO-BURNISHING**

Dry contacts:	1000 $\Omega$ maximum
Wet contacts:	300 V DC maximum
Selectable thresholds:	17 V, 33 V, 84 V, 166 V
Tolerance:	$\pm 10\%$
Contacts per common return:	2
Recognition time:	< 1 ms
Debounce time:	0.0 to 16.0 ms in steps of 0.5
Continuous current draw:	4 mA (when energized)
Auto-burnish impulse current:	50 to 70 mA
Duration of auto-burnish impulse:	25 to 50 ms

**DCMA INPUTS**

Current input (mA DC):	0 to -1, 0 to +1, -1 to +1, 0 to 5, 0 to 10, 0 to 20, 4 to 20 (programmable)
Input impedance:	379 $\Omega \pm 10\%$
Conversion range:	-1 to + 20 mA DC
Accuracy:	$\pm 0.2\%$ of full scale
Type:	Passive

**RTD INPUTS**

Types (3-wire):	100 $\Omega$ Platinum, 100 and 120 $\Omega$ Nickel, 10 $\Omega$ Copper
Sensing current:	5 mA
Range:	-50 to +250°C
Accuracy:	$\pm 2^\circ\text{C}$
Isolation:	36 V pk-pk

**IRIG-B INPUT**

IRIG formats accepted:	B000...B007, B120...B127
IRIG control bits:	IEEE Std C37.118.1-2011
Amplitude modulation:	1 to 10 V pk-pk
DC shift:	TTL-Compatible
Input impedance:	50 k $\Omega$
Isolation:	2 kV

**DIRECT INPUTS**

Input points:	32
Remote devices:	16
Default states on loss of comms.:	On, Off, Latest/Off, Latest/On



Ring configuration:	Yes, No
Data rate:	64 or 128 kbps
CRC:	32-bit
CRC alarm:	
Responding to:	Rate of messages failing the CRC
Monitoring message count:	10 to 10000 in steps of 1
Alarm threshold:	1 to 1000 in steps of 1
Unreturned message alarm:	
Responding to:	Rate of unreturned messages in the ring configuration
Monitoring message count:	10 to 10000 in steps of 1
Alarm threshold:	1 to 1000 in steps of 1

### TELEPROTECTION

Input points:	16
Remote devices:	3
Default states on loss of comms.:	On, Off, Latest/Off, Latest/On
Ring configuration:	No
Data rate:	64 or 128 kbps
CRC:	32-bit

## 2.5.6 Power supply

### LOW RANGE

Nominal DC voltage:	24 to 48 V
Minimum DC voltage:	20 V
Maximum DC voltage:	75 V for SL power supply module
Voltage loss hold-up:	200 ms duration at maximum load

NOTE: Low range is DC only.

### HIGH RANGE

Nominal DC voltage:	125 to 250 V
Minimum DC voltage:	88 V
Maximum DC voltage:	300 V
Nominal AC voltage:	100 to 240 V at 50/60 Hz
Minimum AC voltage:	88 V at 25 to 100 Hz
Maximum AC voltage:	265 V at 25 to 100 Hz
Voltage loss hold-up:	200 ms duration at maximum load

### ALL RANGES

Volt withstand:	2 × Highest Nominal Voltage for 10 ms
Power consumption:	typical = 15 to 20 W/VA maximum = 45 W/VA contact factory for exact order code consumption

### INTERNAL FUSE

Ratings:	
Low range power supply:	8 A / 250 V
High range power supply:	4 A / 250 V
Interrupting capacity:	
AC:	100 000 A RMS symmetrical
DC:	10 000 A

## 2.5.7 Outputs

### FORM-A RELAY

Make and carry for 0.2 s:	30 A as per ANSI C37.90
---------------------------	-------------------------

Carry continuous: 6 A  
 Break (DC inductive, L/R = 40 ms):

Voltage	Current
24 V	1 A
48 V	0.5 A
125 V	0.3 A
250 V	0.2 A

Operate time: < 4 ms  
 Contact material: silver alloy

**LATCHING RELAY**

Make and carry for 0.2 s: 30 A as per ANSI C37.90  
 Carry continuous: 6 A as per IEEE C37.90  
 Break (DC resistive as per IEC61810-1):

Voltage	Current
24 V	6 A
48 V	1.6 A
125 V	0.4 A
250 V	0.2 A

Operate time: < 4 ms  
 Contact material: silver alloy  
 Control: separate operate and reset inputs  
 Control mode: operate-dominant or reset-dominant

**FORM-A VOLTAGE MONITOR**

Applicable voltage: approx. 15 to 250 V DC  
 Trickle current: approx. 1 to 2.5 mA

**FORM-A CURRENT MONITOR**

Threshold current: approx. 80 to 100 mA

**FORM-C AND CRITICAL FAILURE RELAY**

Make and carry for 0.2 s: 30 A as per ANSI C37.90  
 Carry continuous: 8 A  
 Break (DC inductive, L/R = 40 ms):

Voltage	Current
24 V	1 A
48 V	0.5 A
125 V	0.3 A
250 V	0.2 A

Operate time: < 8 ms  
 Contact material: silver alloy

**FAST FORM-C RELAY**

Make and carry: 0.1 A max. (resistive load)

Minimum load impedance:

Input voltage	Impedance	
	2 W Resistor	1 W Resistor
250 V DC	20 K $\Omega$	50 K $\Omega$
120 V DC	5 K $\Omega$	2 K $\Omega$
48 V DC	2 K $\Omega$	2 K $\Omega$
24 V DC	2 K $\Omega$	2 K $\Omega$

Note: values for 24 V and 48 V are the same due to a required 95% voltage drop across the load impedance.

Operate time: < 0.6 ms  
Internal Limiting Resistor: 100  $\Omega$ , 2 W

### SOLID-STATE OUTPUT RELAY

Operate and release time: <100  $\mu$ s  
Maximum voltage: 265 V DC  
Maximum leakage current in off state  
(excluding voltage monitor circuit current): 100  $\mu$ A  
Maximum continuous current: 5 A at 45°C; 4 A at 65°C  
Make and carry:  
for 0.2 s: 30 A as per ANSI C37.90  
for 0.03 s: 300 A  
Breaking capacity:

Specification	UL 508	Utility application (autoreclose scheme)	Industrial application
Operations per interval	5000 operations, 1 second on, 9 seconds off	5 operations 0.2 seconds on 0.2 seconds off within 1 minute	10000 operations 0.2 seconds on 30 seconds off
	1000 operations 0.5 seconds on, 0.5 seconds off		
Break capability (0 to 250 V DC)	3.2 A at L/R = 10 ms	10 A at L/R = 40 ms	10 A at L/R = 40 ms
	1.6 A at L/R = 20 ms		
	0.8 A L/R = 40 ms		

### CONTROL POWER EXTERNAL OUTPUT (For dry contact input)

Capacity: 100 mA DC at 48 V DC  
Isolation:  $\pm$ 300 Vpk

### DIRECT OUTPUTS

Output points: 32

### DCMA OUTPUTS

Range: -1 to 1 mA, 0 to 1 mA, 4 to 20 mA  
Max. load resistance: 12 k $\Omega$  for -1 to 1 mA range  
12 k $\Omega$  for 0 to 1 mA range  
600  $\Omega$  for 4 to 20 mA range  
Accuracy:  $\pm$ 0.75% of full-scale for 0 to 1 mA range  
 $\pm$ 0.5% of full-scale for -1 to 1 mA range  
 $\pm$ 0.75% of full-scale for 0 to 20 mA range  
99% Settling time to a step change: 100 ms  
Isolation: 1.5 kV  
Driving signal: any FlexAnalog quantity  
Upper and lower limit for the driving signal: -90 to 90 pu in steps of 0.001

## 2.5.8 Communication protocols

### IEC 61850

IEC 61850: Supports IEC 61850 Editions 1.0 and 2.0. See the UR Family Communications Guide and its conformance statements.

### RS232 (Enhanced and basic front panels)

Front port: 19.2 kbps, Modbus RTU

### USB (Graphical front panel)

Front port: USB 2.0 type B

### RS485

1 rear port: up to 115 kbps, Modbus RTU, DNP 3, IEC 60870-5-103

Typical distance: 1200 m

Isolation: 2 kV, isolated together at 36 Vpk

### FIBER ETHERNET PORT

Parameter	Fiber type
	100 Mb multimode
Wavelength	1310 nm
Connector	LC
Transmit power	-20 dBm
Receiver sensitivity	-30 dBm
Power budget	10 dB
Maximum input power	-14 dBm
Typical distance	2 km
Full duplex	yes
Redundancy	yes

### ETHERNET (10/100 MB TWISTED PAIR)

Modes: 10 Mb, 10/100 Mb (auto-detect)

Connector: RJ45

### SIMPLE NETWORK TIME PROTOCOL (SNTP)

Clock synchronization error: <10 ms (typical)

### PRECISION TIME PROTOCOL (PTP)

PTP IEEE Std 1588 2008 (version 2)

Power Profile (PP) per IEEE Standard PC37.238TM2011

Slave-only ordinary clock

Peer delay measurement mechanism

### PARALLEL REDUNDANCY PROTOCOL (PRP) (IEC 62439-3 CLAUSE 4, 2012)

Ethernet ports used: 2 and 3

Networks supported: 10/100 Mb Ethernet

### OTHER

TFTP, SFTP, HTTP, IEC 60870-5-104, Ethernet Global Data (EGD), IEEE C37.118

## 2.5.9 Inter-relay communications

### SHIELDED TWISTED-PAIR INTERFACE OPTIONS

Interface type	Typical distance
RS422	1200 m
G.703	100 m



RS422 distance is based on transmitter power and does not take into consideration the clock source provided by the user.

NOTE

### LINK POWER BUDGET AND MAXIMUM OPTICAL INPUT POWER

The following specifications apply to filter interface modules manufactured from January 2012.

Emitter, fiber type	Cable type	Transmit power	Received sensitivity	Power budget	Maximum optical input power
820 nm, Multimode	62.5/125 $\mu\text{m}$	-16 dBm	-32 dBm	16 dBm	-8 dBm
	50/125 $\mu\text{m}$	-20 dBm		12 dBm	
1300 nm, Multimode	62.5/125 $\mu\text{m}$	-16 dBm	-32 dBm	16 dBm	-8 dBm
	50/125 $\mu\text{m}$	-20 dBm		12 dBm	
1300 nm, Single mode	9/125 $\mu\text{m}$	-15 dBm	-32 dBm	17 dBm	-8 dBm
1300 nm Laser, Single mode	9/125 $\mu\text{m}$	0 dBm	-34 dBm	34 dBm	-8 dBm
1550 nm Laser, Single mode	9/125 $\mu\text{m}$	5 dBm	-34 dBm	39 dBm	-10 dBm

The following specifications apply to filter interface modules implemented before January 2012.

Emitter, fiber type	Transmit power	Received sensitivity	Power budget	Maximum optical input power
820 nm LED, Multimode	-20 dBm	-30 dBm	10 dB	-7.6 dBm
1300 nm LED, Multimode	-21 dBm	-30 dBm	9 dB	-11 dBm
1300 nm ELED, Single mode	-23 dBm	-32 dBm	9 dB	-14 dBm
1300 nm Laser, Single mode	-1 dBm	-30 dBm	29 dB	-14 dBm
1550 nm Laser, Single mode	+5 dBm	-30 dBm	35 dB	-14 dBm



The power budgets are calculated from the manufacturer's worst-case transmitter power and worst case receiver sensitivity.

NOTE

The power budgets for the 1300 nm ELED are calculated from the manufacturer's transmitter power and receiver sensitivity at ambient temperature. At extreme temperatures these values deviate based on component tolerance. On average, the output power decreases as the temperature is increased by a factor of 1 dB / 5 °C.

**TYPICAL LINK DISTANCE**

Emitter, fiber type	Cable type	Connector type	Typical distance	
			Before January 2012	From January 2012
820 nm LED, multimode	62.5/125 μm	ST	1.65 km	2 km
	50/125 μm	ST	1.65 km	2 km
1300 nm LED, multimode	62.5/125 μm	ST	4 km	5 km
	50/125 μm	ST	4 km	5 km
1300 nm ELED, single mode	9/125 μm	ST	11.4 km	20 km
1300 nm Laser, single mode	9/125 μm	ST	64 km	65 km
1550 nm Laser, single mode	9/125 μm	ST	105 km	125 km



Typical distances listed are based on the following assumptions for system loss. As actual losses vary from one installation to another, the distance covered by your system can vary.

**CONNECTOR LOSSES (Total of both ends)**

ST connector: 0.7 dB (each)

**FIBER LOSSES**

820 nm multimode: 3 dB/km  
 1300 nm multimode: 1 dB/km  
 1300 nm single mode: 0.35 dB/km  
 1550 nm single mode: 0.25 dB/km  
 Splice losses: one splice every 2 km at 0.05 dB loss per splice

**SYSTEM MARGIN**

3 dB additional loss added to calculations to compensate for all other losses.

Compensated difference in transmitting and receiving (channel asymmetry) channel delays using GPS satellite clock: 10 ms

**2.5.10 CyberSentry security**

**OPTIONS**

Software options: Level 1

**2.5.11 Graphical front panel**

**DISPLAY**

Type: color graphical back-lit LCD display  
 Size: 7 inches (17.8 cm)  
 Resolution: 800 by 480 pixels  
 Pages: 5 single-line diagram pages with controls, status, and metering values  
 up to 8 annunciator pages with total of 96 annunciator windows  
 1 phasor metering page for each AC Source  
 5 tabular metering pages with dynamic metering and status  
 event records page with dynamic update  
 product information page  
 settings, actual values, error messages (targets)

**LED INDICATORS**

Functions: 5 device status indicators  
 9 event cause indicators  
 8 user-programmable pushbutton indicators

**PUSHBUTTONS**

Type: membrane  
 Functions: 5 bottom Tab pushbuttons and 1 Home pushbutton for page recall  
 4 directional, 1 ENTER, and 1 ESCAPE pushbutton element selection  
 10 side pushbuttons for power system element control  
 RESET pushbutton  
 8 physical user-programmable pushbuttons, 8 graphical interface pushbuttons

**INGRESS PROTECTION**

IP code: IP54 front, IP10 back (IP20 back with IP20 cover accessory)

**2.5.12 Environmental****AMBIENT TEMPERATURES**

Storage temperature: -40 to 85°C  
 Operating temperature: -40 to 60°C; the LCD contrast can be impaired at temperatures less than -20°C

**HUMIDITY**

Humidity: operating up to 95% (non-condensing) at 55°C (as per IEC60068-2-30 variant 1, 6 days)

**OTHER**

Altitude: 2000 m (maximum)  
 Pollution degree: II  
 Overvoltage category: II  
 Ingress protection: IP20 front, IP10 back (basic front panel and Rev. 1 enhanced front panel)  
 IP40 front, IP10 back (Rev. 2 enhanced front panel)  
 IP54 front with IP54 mounting collar accessory (Rev. 2 enhanced front panel)  
 Ingress protection with IP20 cover accessory: IP20 back  
 Noise: 0 dB

## 2.5.13 Type tests

### G30 TYPE TESTS

Test	Reference standard	Test level
Dielectric voltage withstand	EN 60255-5 <sup>1</sup>	2.2 kV
Impulse voltage withstand	EN 60255-5 <sup>1</sup>	5 kV
Damped oscillatory	IEC 61000-4-18 / IEC 60255-22-1	2.5 kV CM, 1 kV DM
Electrostatic discharge	EN 61000-4-2 / IEC 60255-22-2	Level 3
RF immunity	EN 61000-4-3 / IEC 60255-22-3	Level 3
Fast transient disturbance	EN 61000-4-4 / IEC 60255-22-4	Class A and B
Surge immunity	EN 61000-4-5 / IEC 60255-22-5	Level 3 and 4
Conducted RF immunity	EN 61000-4-6 / IEC 60255-22-6	Level 3
Power frequency immunity	EN 61000-4-7 <sup>1</sup> / IEC 60255-22-7	Class A and B
Voltage interruption and ripple DC	IEC 60255-11	12% ripple, 200 ms interrupts
Radiated and conducted emissions	CISPR11 / CISPR22 / IEC 60255-25	Class A
Sinusoidal vibration	IEC 60255-21-1	Class 1
Shock and bump	IEC 60255-21-2	Class 1
Seismic	IEC 60255-21-3	Class 1
Power magnetic immunity	IEC 61000-4-8	Level 5
Pulse magnetic immunity	IEC 61000-4-9	Level 4
Damped magnetic immunity	IEC 61000-4-10	Level 4
Voltage dip and interruption	IEC 61000-4-11	0, 40, 70, 80% dips; 250 / 300 cycle interrupts
Damped oscillatory	IEC 61000-4-12 <sup>1</sup>	2.5 kV CM, 1 kV DM
Conducted RF immunity, 0 to 150 kHz	IEC 61000-4-16	Level 4
Voltage ripple	IEC 61000-4-17	15% ripple
Ingress protection	IEC 60529 <sup>1</sup>	IP20 front, IP10 back
Cold	IEC 60068-2-1	-40°C for 16 hours
Hot	IEC 60068-2-2	85°C for 16 hours
Humidity	IEC 60068-2-30	6 days, variant 1
Damped oscillatory	IEEE/ANSI C37.90.1	2.5 kV, 1 MHz
RF immunity	IEEE/ANSI C37.90.2	20 V/m, 80 MHz to 1 GHz
Safety	UL 508	e83849 NKCR
		Section 43 - Temperature test Energization of Contact Inputs and/or Contact Outputs for continuous duty is not to exceed a total of 31 W of power
Safety	UL C22.2-14	e83849 NKCR7
Safety	UL 1053	e83849 NKCR
Safety	IEC 60255-27	Insulation: class 1, Pollution degree: 2, Over voltage cat II

<sup>1</sup> Not tested by third party.

## 2.5.14 Production tests

### THERMAL

Products go through an environmental test based upon an Accepted Quality Level (AQL) sampling process.



## 2.5.15 Approvals

### APPROVALS

Compliance	Applicable council directive	According to
CE	Low voltage directive	EN 60255-5
	EMC directive	EN 60255-26 / EN 50263
		EN 61000-6-5
C-UL-US	---	UL 508
		UL 1053
		C22.2 No. 14

## 2.5.16 Maintenance

### MOUNTING

Attach mounting brackets using 20 inch-pounds ( $\pm 2$  inch-pounds) of torque.

### CLEANING

Normally, cleaning is not required. When dust has accumulated on the front panel display, wipe with a dry cloth.

### **NOTICE**

To avoid deterioration of electrolytic capacitors, power up units that are stored in a de-energized state once per year, for one hour continuously.

2

# G30 Generator Protection System

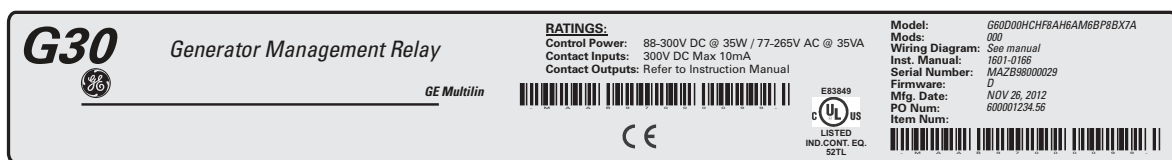
## Chapter 3: Installation

This chapter outlines installation of hardware and software. You unpack, mount, wire the unit, turn on power, then install the software and configure settings.

### 3.1 Unpack and inspect

To unpack and inspect the unit:

1. Open the relay package and check that the following items have been delivered:
  - G30
  - Mounting screws
  - GE EnerVista™ DVD (software and documentation)
  - G30 Instruction Manual (soft copy on DVD; printed copy if ordered)
  - UR Family Communications Guide (soft copy on DVD; printed copy if Instruction Manual ordered)
  - Certificate of Calibration
  - Test Report
  - EC Declaration of Conformity
  - Front panel label package
2. Inspect the unit for physical damage.
3. View the rear nameplate and verify that the correct model has been delivered. The model number is at the top right.



4. Any protective plastic film on the front panel is normally peeled off, but also can be left on.
5. For any issues, contact GE as outlined in the For Further Assistance section in chapter 1.
6. Check that you have the latest copy of the G30 Instruction Manual and the UR Family Communications Guide, for the applicable firmware version, at <http://www.gegridsolutions.com/multilin/manuals/index.htm>

The Instruction Manual outlines how to install, configure, and use the unit. The Communications Guide is for advanced use with communication protocols. The warranty is included at the end of this instruction manual and on the GE Grid Solutions website.

---

## 3.2 Panel cutouts

This section does not apply to the HardFiber Brick; see its instruction manual.

Install the relay in an indoor environment within the environmental specifications. The relay complies with Pollution Category II, which means installation in an office, laboratory, or testing environment.

### 3.2.1 Horizontal units

The G30 is available as a 19-inch rack horizontal mount unit with a removable front panel. The front panel is specified as enhanced, basic, or graphical at the time of ordering. The enhanced and graphical front panels have additional user-programmable pushbuttons and LED indicators, while the basic front panel has additional user-programmable pushbuttons.

The modular design allows the relay to be upgraded and repaired by qualified service personnel. The front panel is hinged to allow access to the modules. The front panel is itself removable to allow mounting on doors with limited rear depth and for upgrading.

In November 2017, GE began transitioning to Rev. 2 of the enhanced horizontal front panel. This panel can be identified by the use of a screw instead of a knob to close the panel. It can conform to an IP54 rating with the IP54 mounting collar purchased separately. The IP54 mounting collar can be used in panel-mount installations, not 19-inch rack-mount installations. The IP54 mounting collar cannot be used with Rev. 1 enhanced front panels.

The case dimensions are shown in the following figures, along with panel cutout details for panel mounting. When planning the location of your panel cutout, ensure that provision is made for the front panel to swing open without interference to or from adjacent equipment.

Mount the relay such that the front panel sits semi-flush with the panel or switchgear door, allowing the operator access to the keypad and the front communications port.

Figure 3-1: Horizontal dimensions (Rev. 1 enhanced front panel)

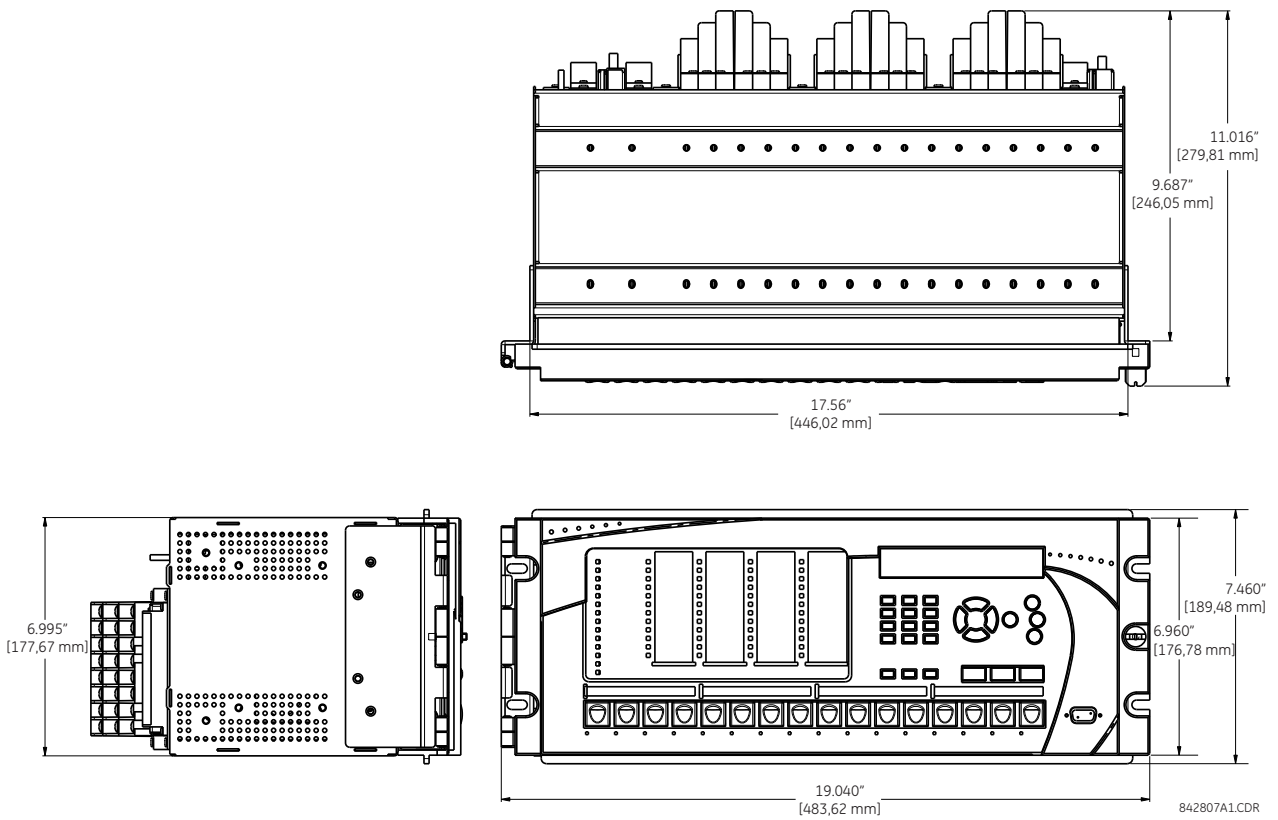


Figure 3-2: Horizontal dimensions (Rev. 2 enhanced front panel)

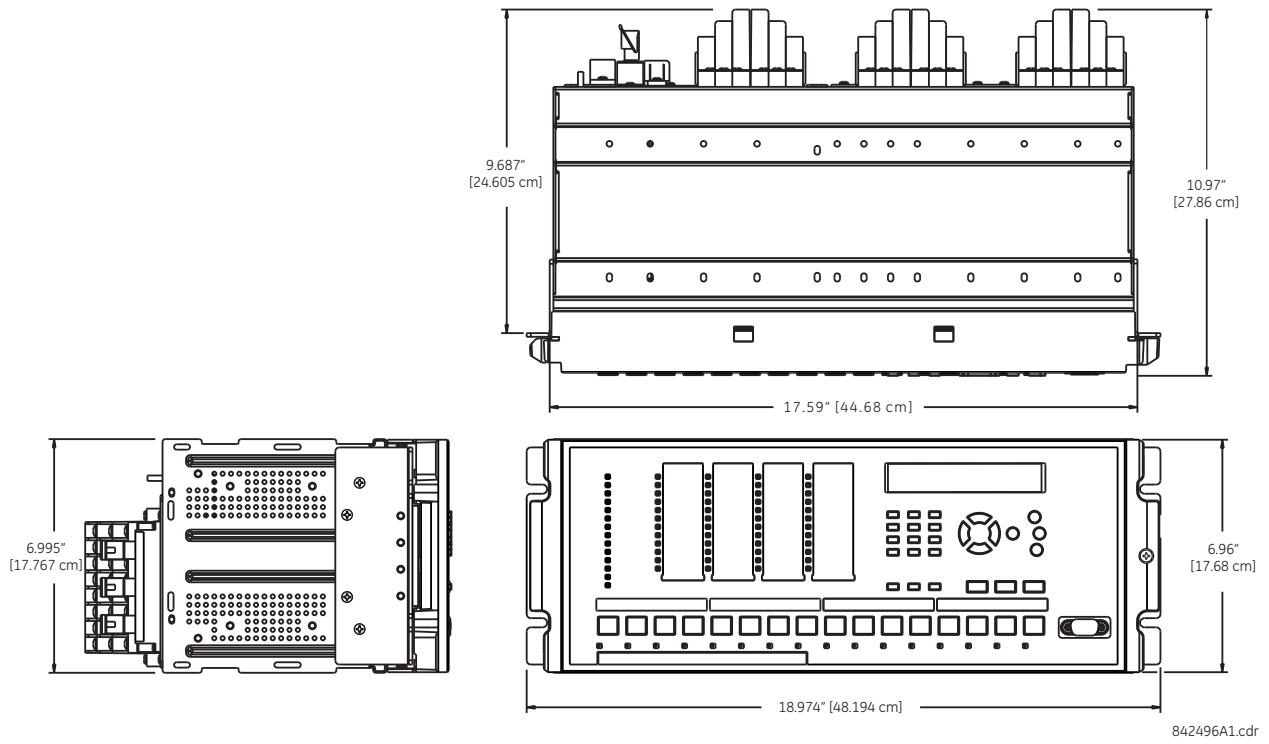


Figure 3-3: Horizontal mounting (enhanced and graphical front panels)

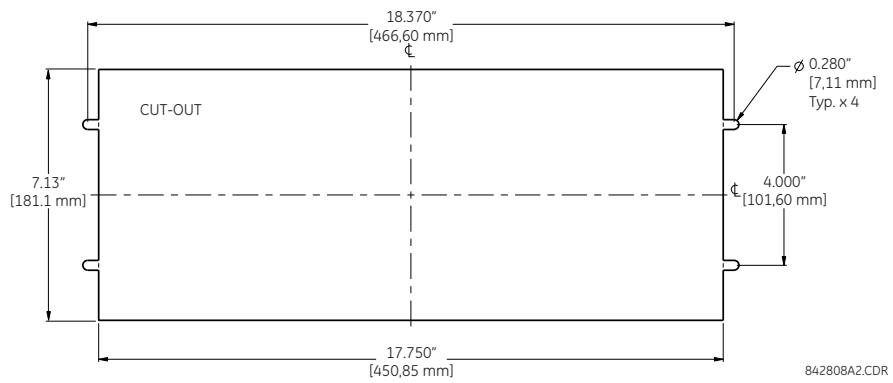


Figure 3-4: Horizontal dimensions and mounting (basic front panel)

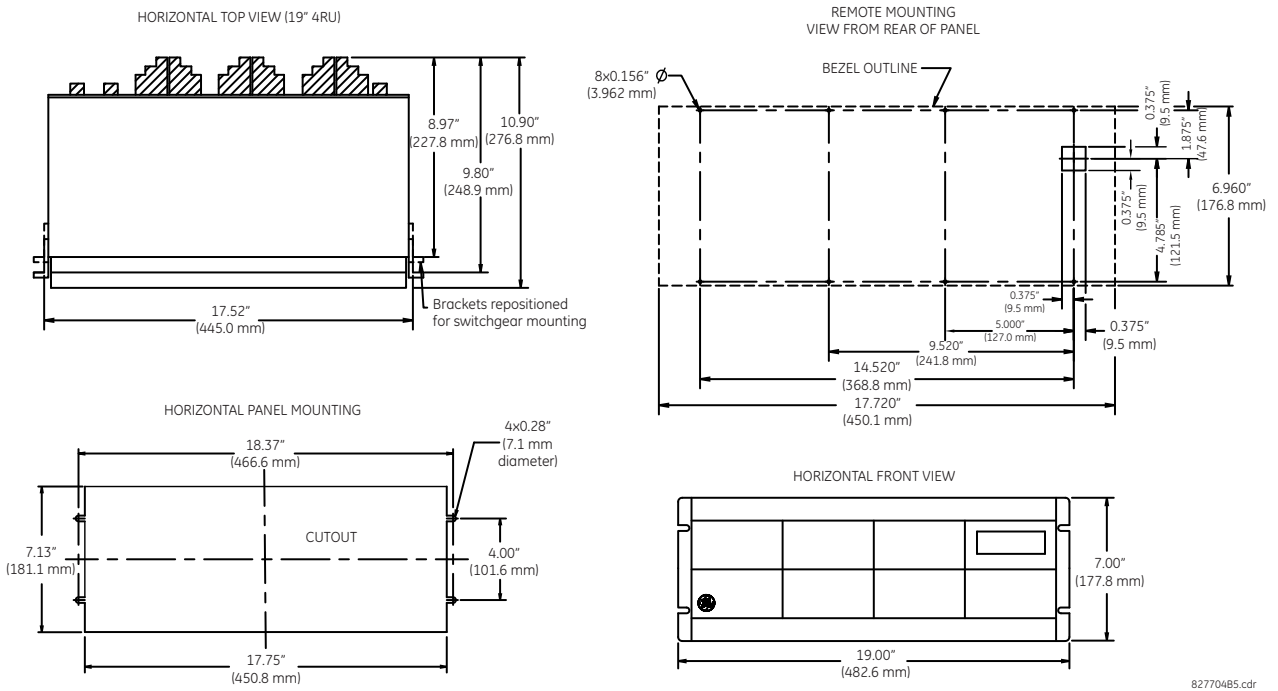


Figure 3-5: Horizontal dimensions (graphical front panel)

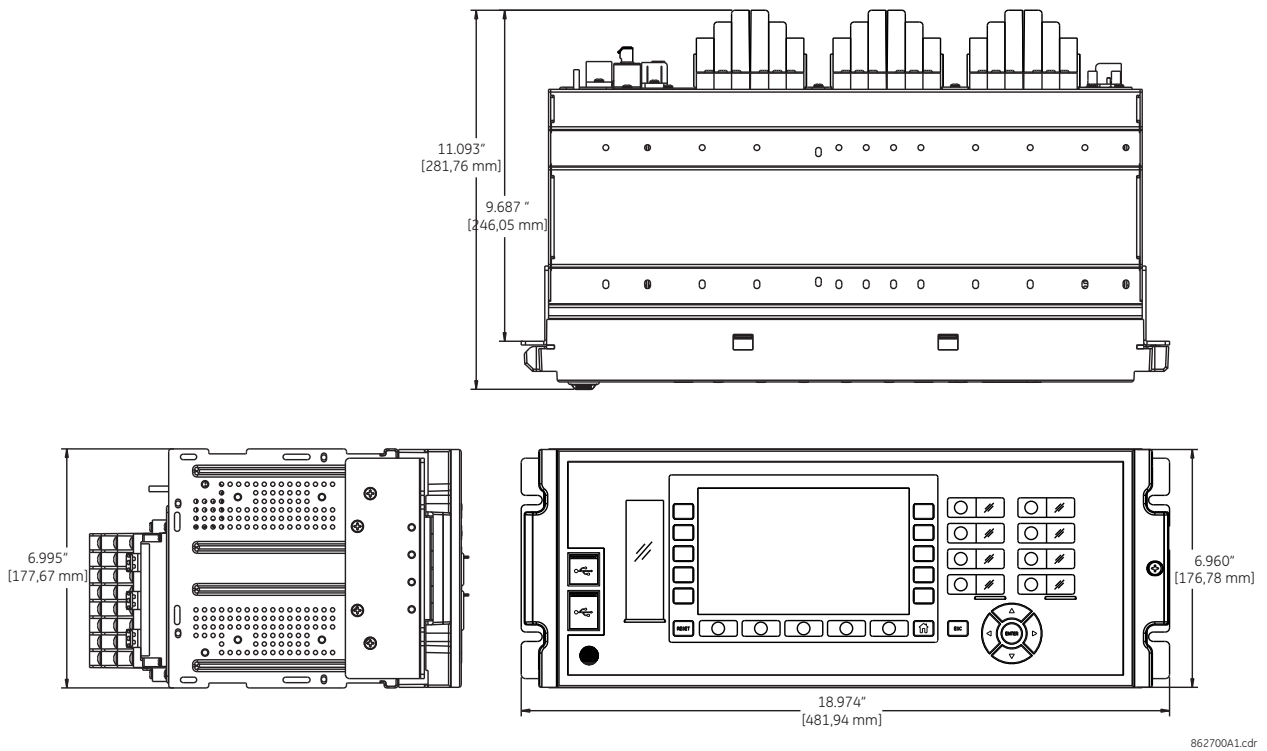
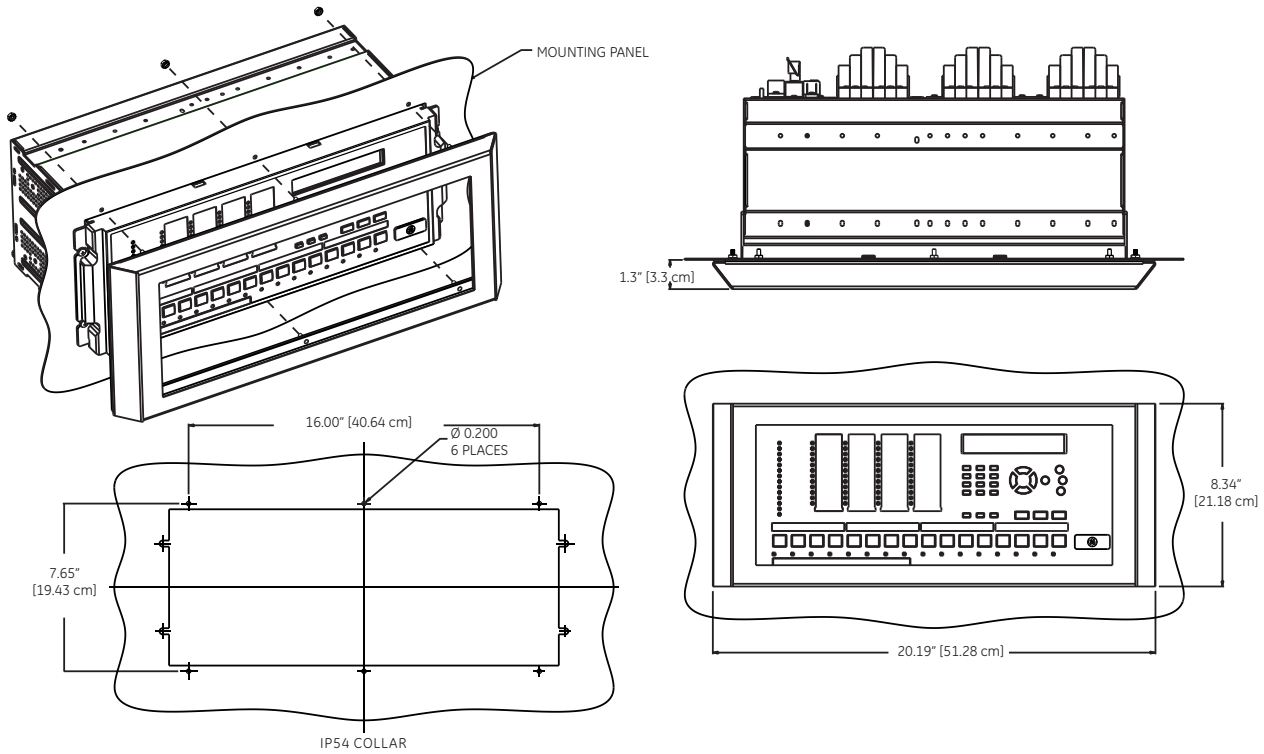


Figure 3-6: Horizontal dimensions (IP54 mounting collar)



- NOTES
1. INSPECT THE COLLAR BEFORE INSTALLATION. VERIFY GASKET IS ADHERED TO THE METAL ON ALL SIDES
  2. MAKE SURE THE RELAY IS POSITIONED CENTER TO THE CUT OUT
  3. INSTALL IP-54 COLLAR, CONFIRM THE GASKET PROPERLY MATES WITH THE PANEL ON ALL SIDES SECURE USING #8-32 HEX NUT AT 6 PLACES.

842497A1.cdr

### 3.2.2 Vertical units

The G30 is available as a reduced size (¾) vertical mount unit, with a removable front panel. The front panel is specified as enhanced or basic at the time of ordering. The enhanced front panel contains additional user-programmable pushbuttons and LED indicators, while the basic front panel has additional user-programmable pushbuttons.

The modular design allows the relay to be upgraded and repaired by qualified service personnel. The front panel is hinged to allow easy access to the modules. The front panel is itself removable to allow mounting on doors with limited rear depth and for upgrading.

The case dimensions are shown in the following figures, along with panel cutout details for panel mounting. When planning the location of your panel cutout, ensure that provision is made for the front panel to swing open without interference to or from adjacent equipment.

Mount the relay such that the front panel sits semi-flush with the panel or switchgear door, allowing the operator access to the keypad and the RS232 communications port.

3



Figure 3-7: Vertical dimensions and mounting (enhanced front panel)

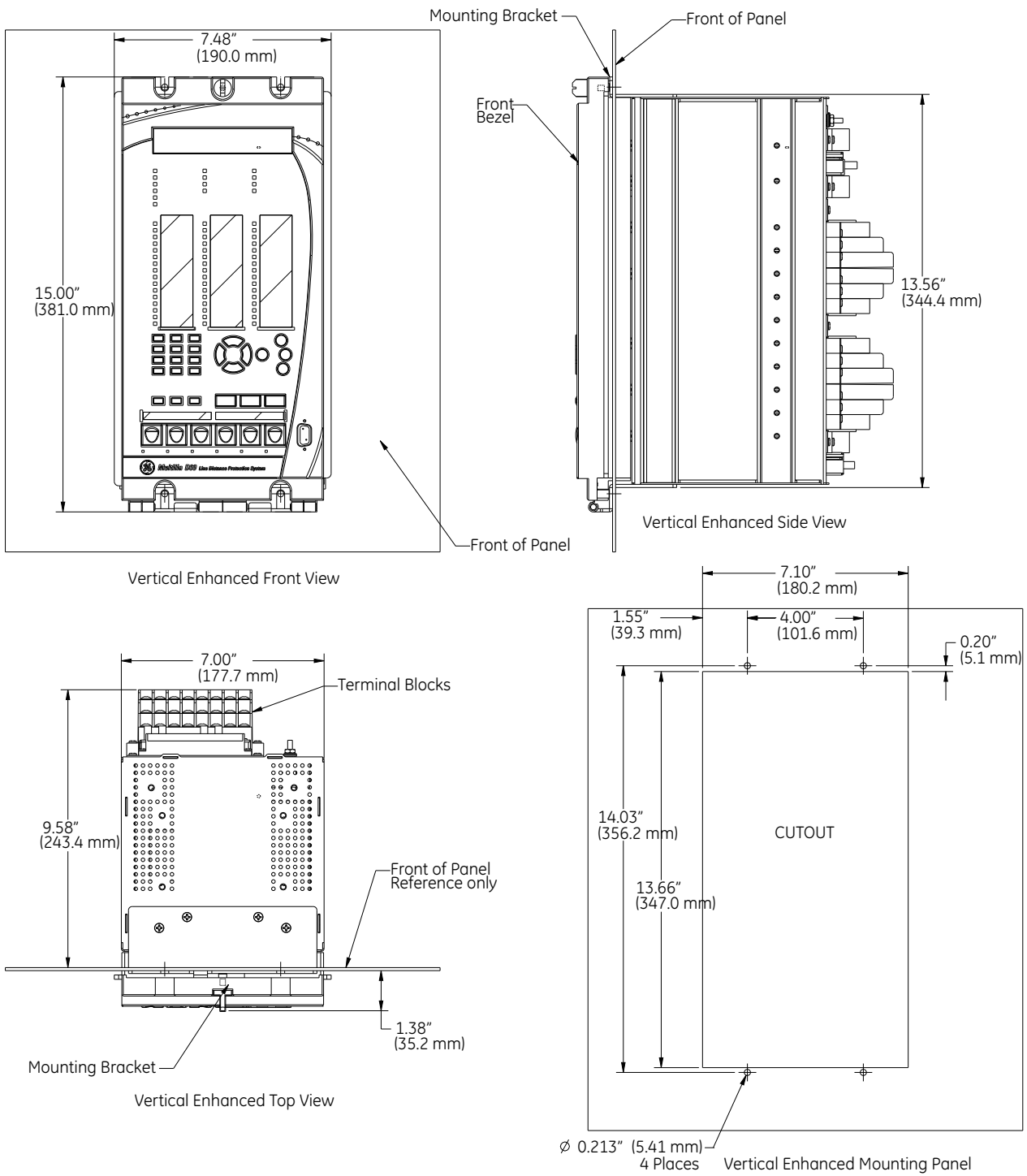
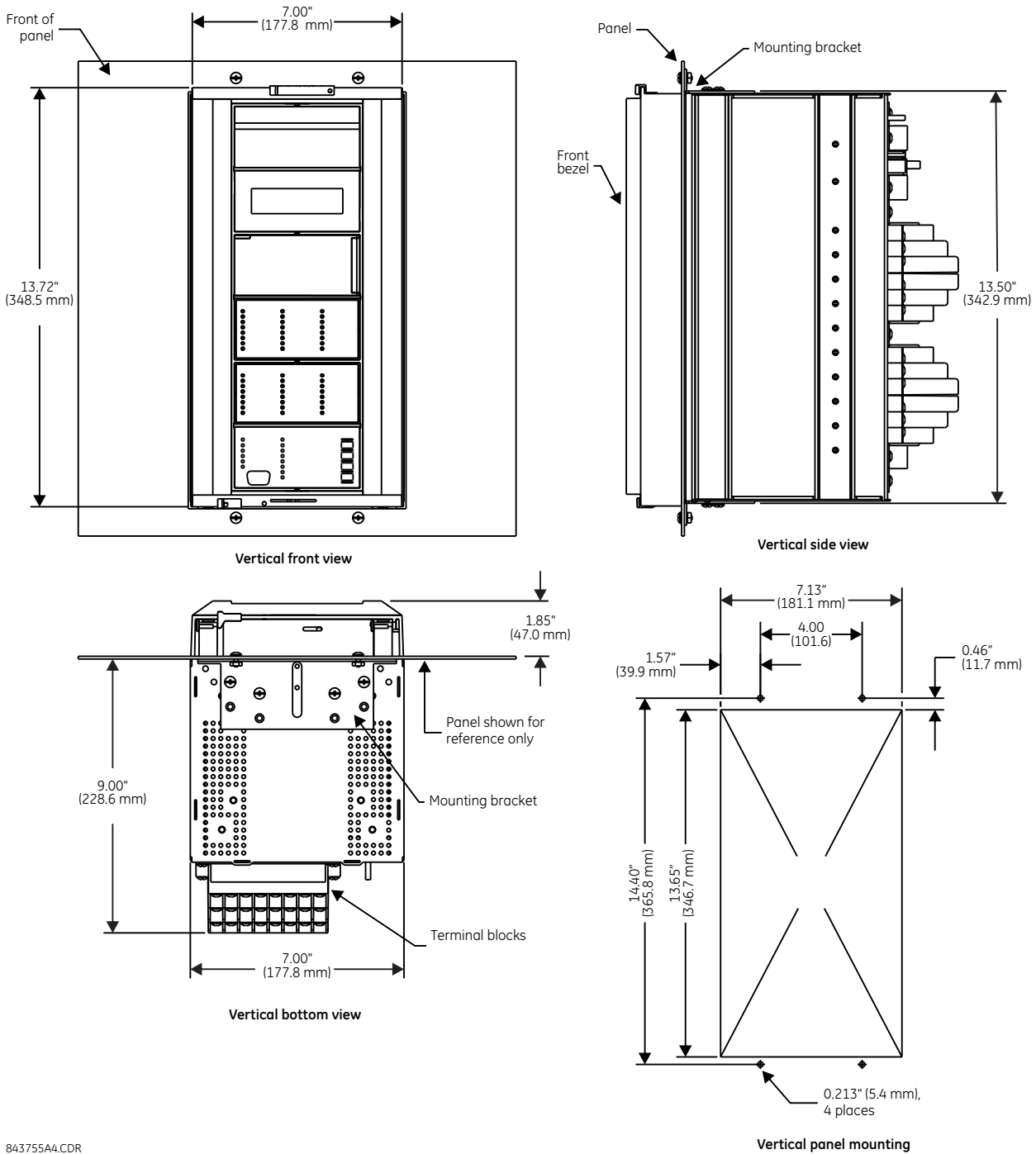


Figure 3-8: Vertical dimensions and mounting (basic front panel)



843755A4.CDR

For side-mounting G30 devices with the enhanced front panel, see the following documents available on the UR DVD and the GE Grid Solutions website:

- [GEK-113180](#) — UR-Series UR-V Side-Mounting Front Panel Assembly Instructions
- [GEK-113181](#) — Connecting a Remote UR-V Enhanced Front Panel to a Vertical UR Device Instruction Sheet
- [GEK-113182](#) — Connecting a Remote UR-V Enhanced Front Panel to a Vertically-Mounted Horizontal UR Device Instruction Sheet

For side-mounting G30 devices with the basic front panel, use the following figures.

Figure 3-9: Vertical side-mounting installation (basic front panel)

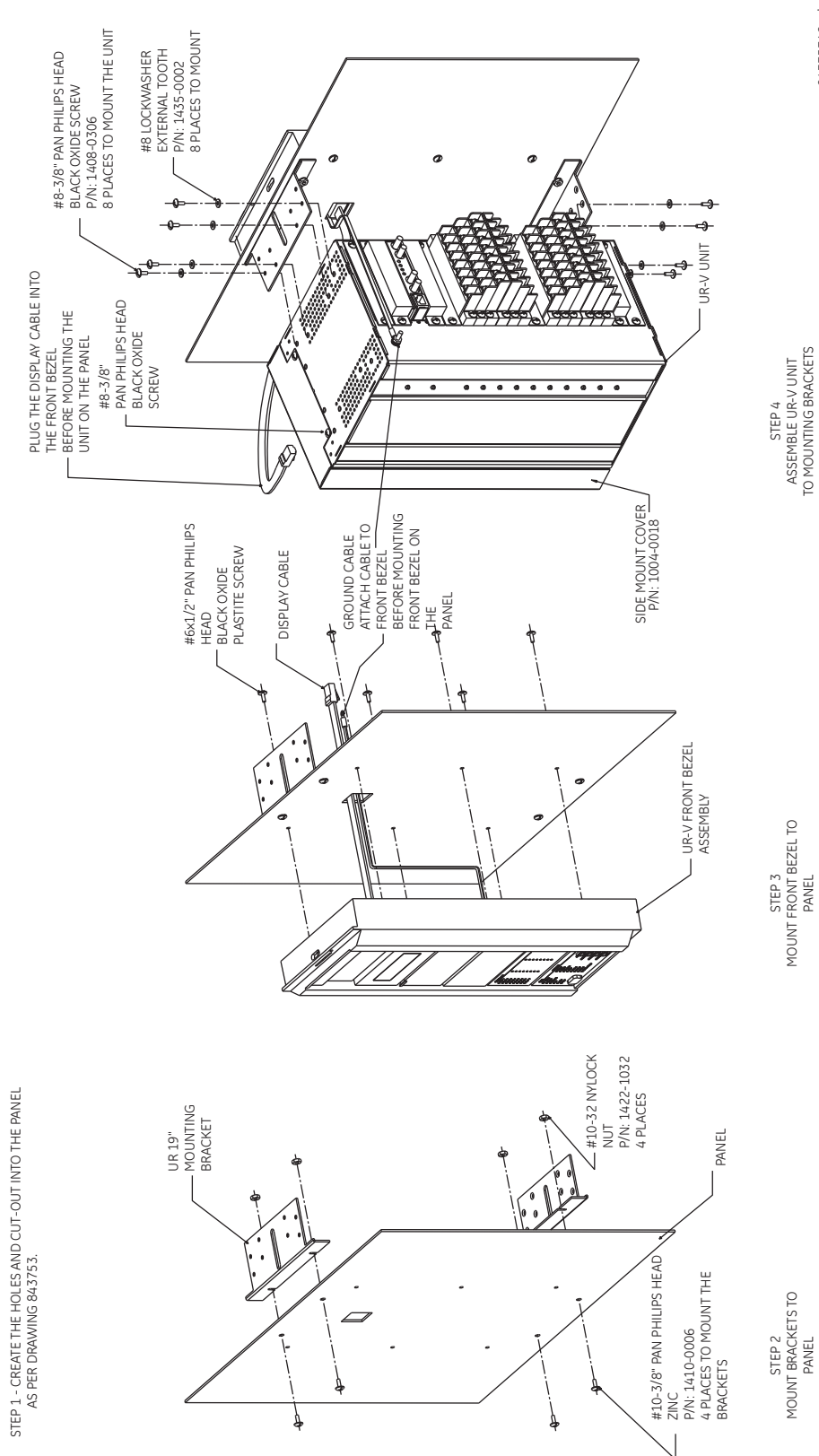
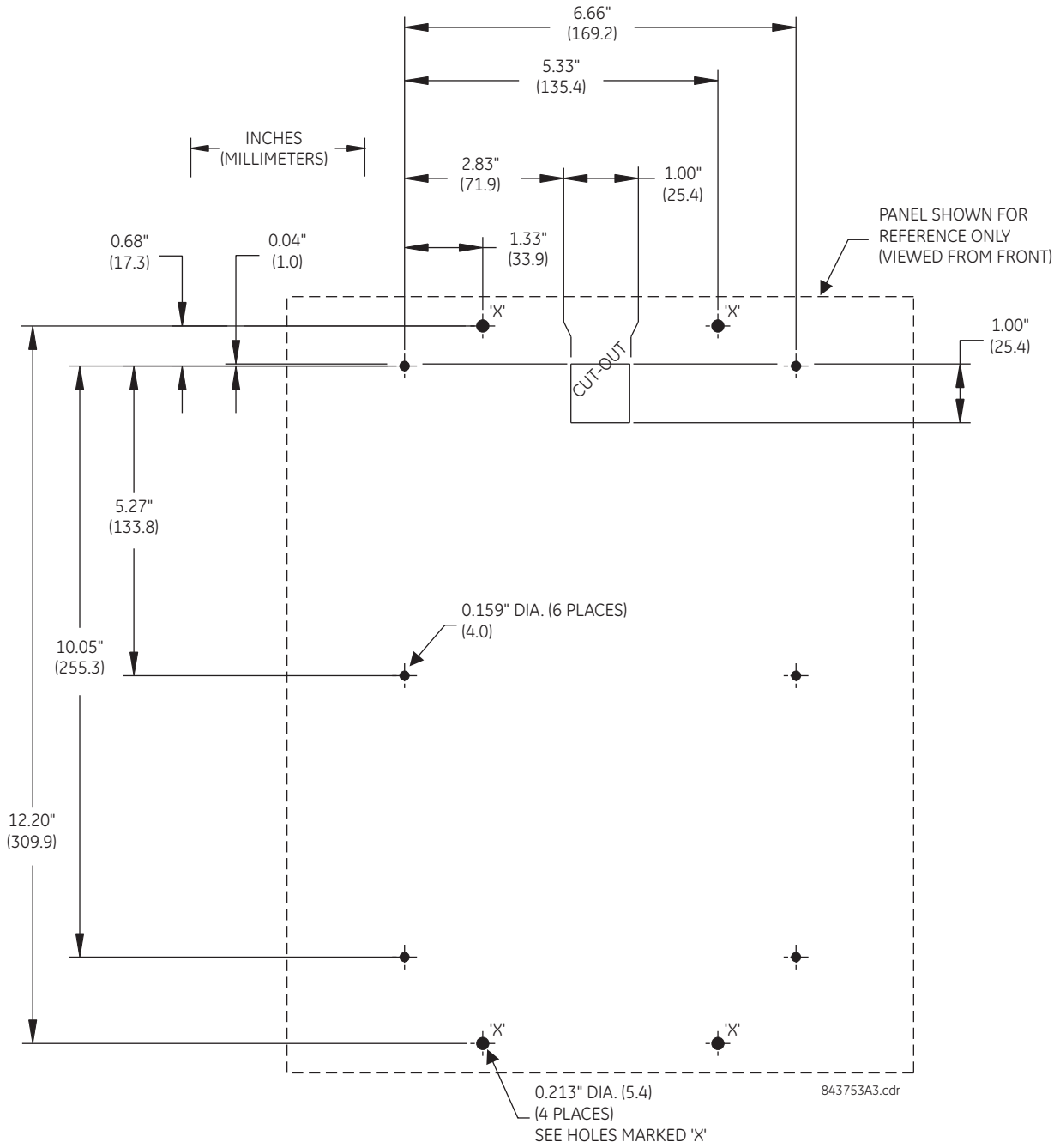
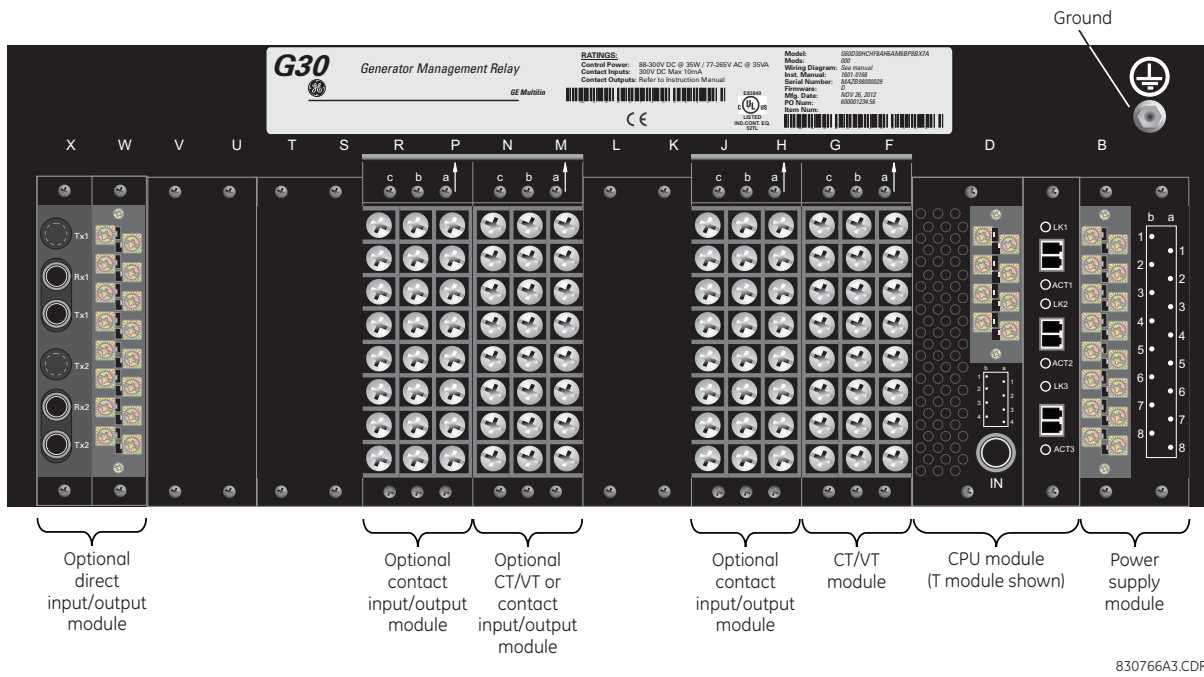


Figure 3-10: Vertical side-mounting rear dimensions (basic front panel)



### 3.2.3 Rear terminal layout

The rear terminals depend on order code. An example is shown.



**WARNING**

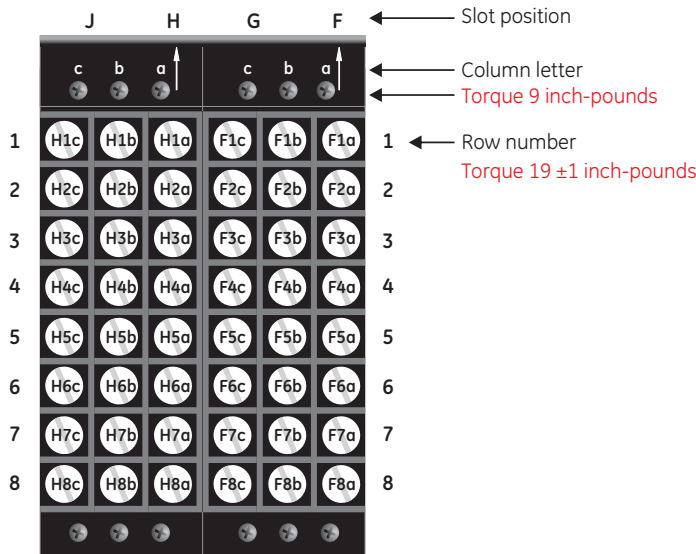
Do not touch any rear terminals while the relay is energized, else death or serious injury can result from electrical shock.

**NOTICE**

Small form-factor pluggable ports (SFPs) are pluggable transceivers. They transmit, receive, and convert electrical signals to optical signals and vice-versa. Supplied with the device, they are inserted into the Ethernet ports on the CPU module. A photo in the Maintenance chapter shows this plug-in device. Do not use non-validated transceivers or install validated transceivers in the wrong Ethernet slot, else damage can occur.

Terminal number assignments are three characters long and assigned by module slot position, row number, and column letter. Two-slot wide modules take their slot designation from the first slot position (nearest to CPU module), indicated by an arrow on the terminal block. The figure shows an example of rear terminal assignments.

Figure 3-11: Example of modules in F and H slots

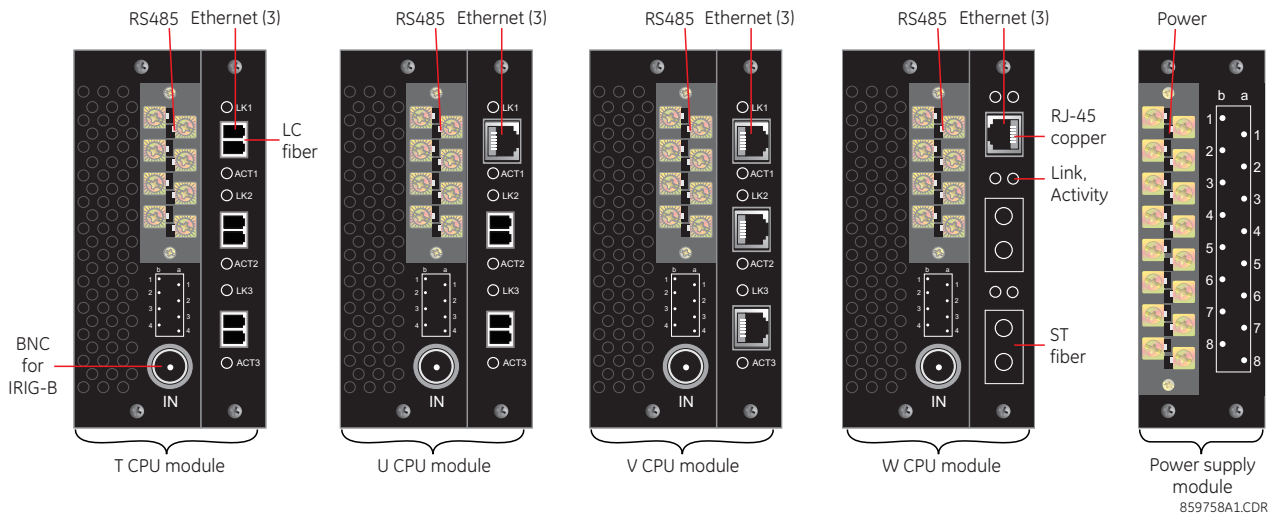


842761A2.CDR

The torque used to connect the screws that connect the terminal blocks (top screws a, b, c) and the metal plates over empty slots to the chassis is 9 inch-pounds. For the screws used to wire the terminal blocks (rows 1 to 8), use 19±1 inch-pounds.

The CPU module type depends on order code. During manufacturing, the power supply and CPU modules are installed in slots B and D of the chassis with 13 inch-pounds of torque on the screws at the top and bottom of the modules. Wire connections to these two modules at 13 inch-pounds.

Figure 3-12: CPU modules and power supply



859758A1.CDR

The following figure shows the optical connectors for CPU modules.

Figure 3-13: LC fiber connector (left) and ST fiber connector (right)



### 3.3 Wiring

#### 3.3.1 Typical wiring

Figure 3-14: Typical wiring diagram (T module shown for CPU)

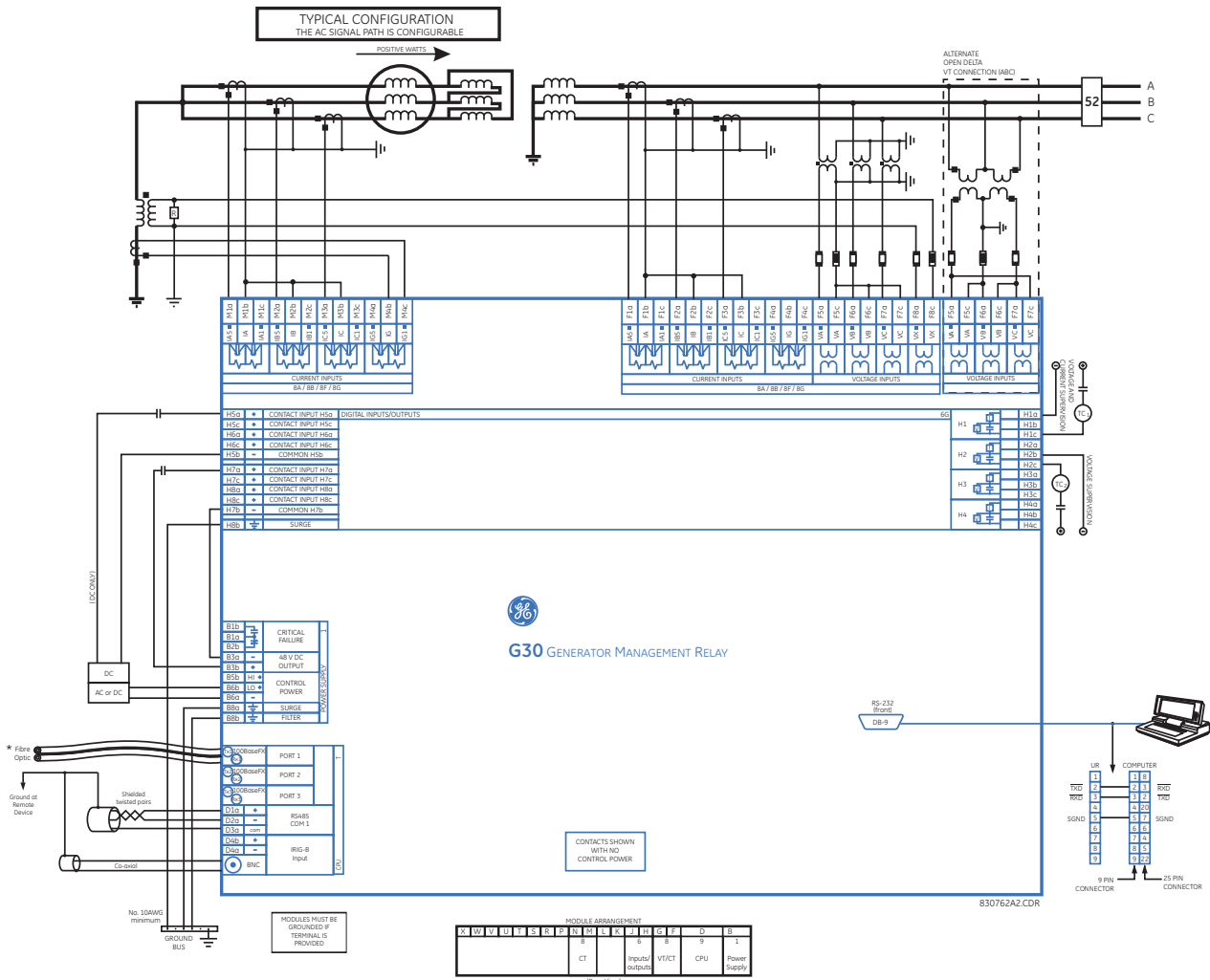
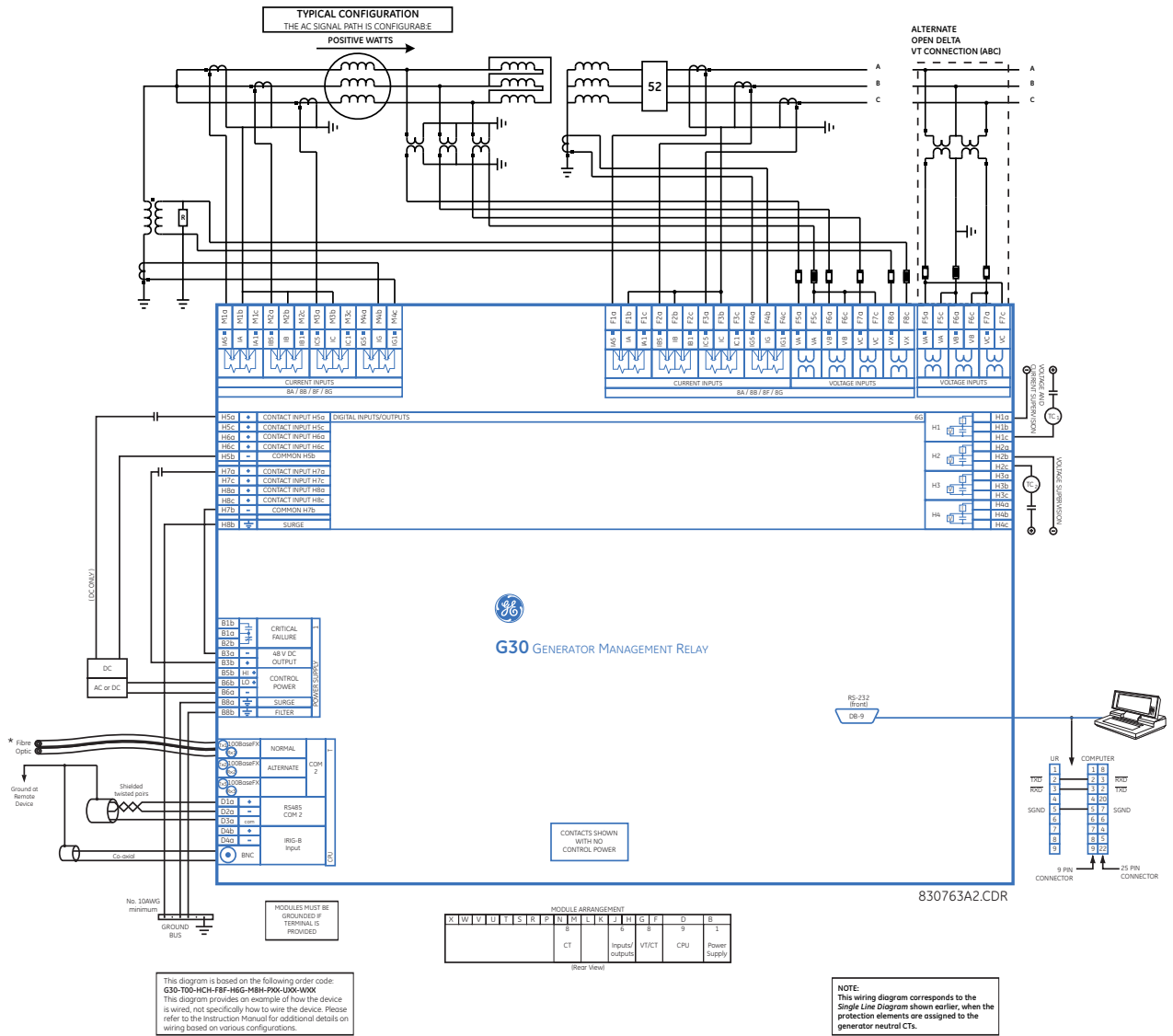


Figure 3-15: Typical wiring diagram, PTS on the transformer LV-side (T module shown for CPU)

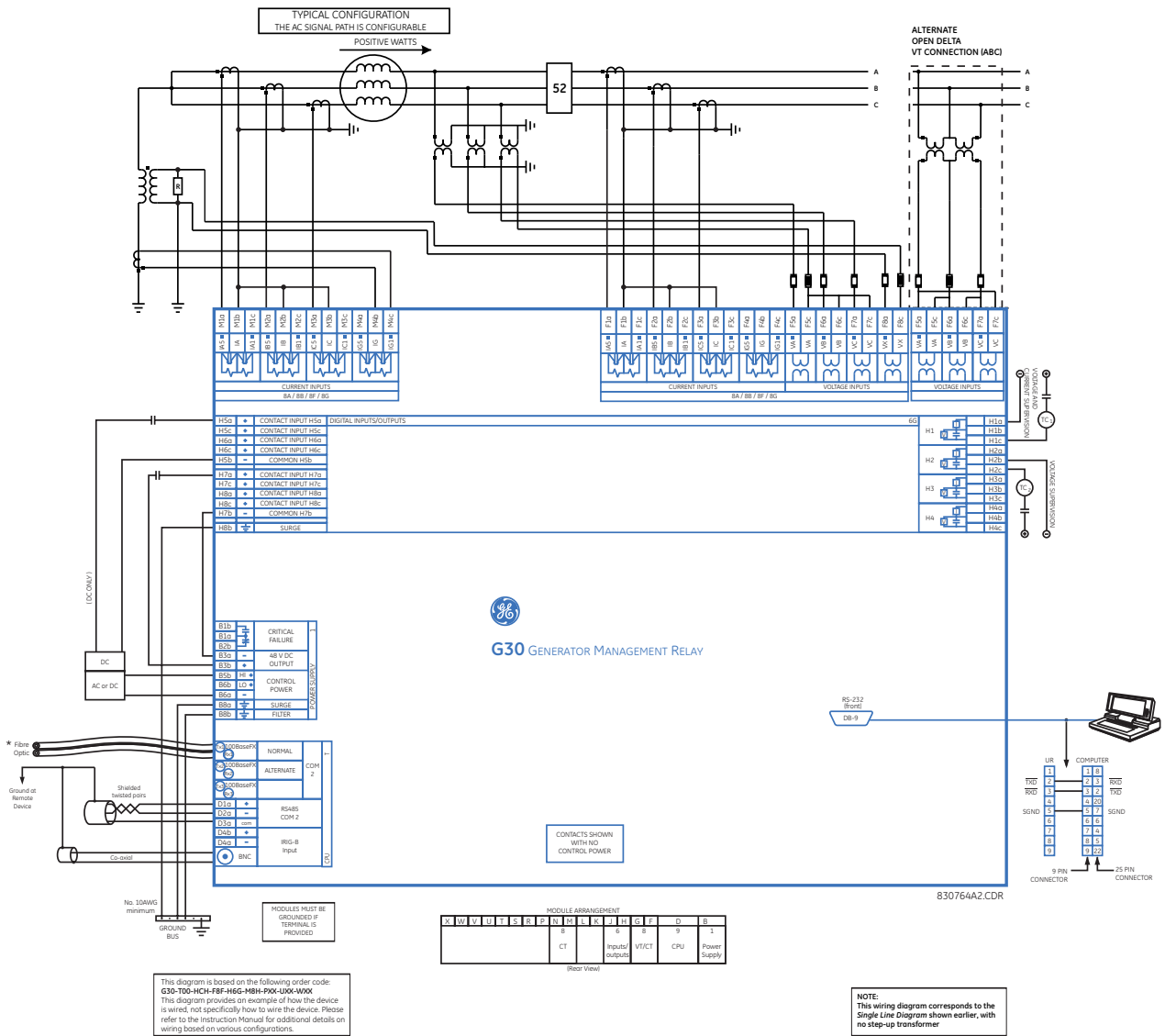
3



This diagram is based on the following order code: G30-700-HCH-RF-H6G-H8H-P90-1000-W00. This diagram provides an example of how the device is wired, not specifically how to wire the device. Please refer to the Instruction Manual for additional details on wiring based on various configurations.



Figure 3-16: Typical wiring diagram, no transformer (T module shown for CPU)



### 3.3.2 Dielectric strength

Dielectric strength is the maximum electric strength that can be sustained without breakdown. It is measured in volts. The table shows the dielectric strength of the UR-series module hardware.

**Table 3-1: Dielectric strength of UR modules**

Module type	Module function	Terminals		Dielectric strength
		From	To	
1	Power supply	High (+); Low (+); (-)	Chassis	2000 V AC for 1 minute
1	Power supply	48 V DC (+) and (-)	Chassis	2000 V AC for 1 minute
1	Power supply	Relay terminals	Chassis	2000 V AC for 1 minute
2	Reserved	N/A	N/A	N/A
3	Reserved	N/A	N/A	N/A
4	Digital contact inputs/ outputs	All	Chassis	2000 V AC for 1 minute
5	Analog inputs/outputs	All except 8b	Chassis	< 50 V DC
6	Digital contact inputs/ outputs	All	Chassis	2000 V AC for 1 minute
7	G.703	All except 2b, 3a, 7b, 8a	Chassis	2000 V AC for 1 minute
	RS422	All except 6a, 7b, 8a	Chassis	< 50 V DC
8	CT/VT	All	Chassis	2000 V AC for 1 minute
9	CPU	All	Chassis	2000 V AC for 1 minute

**NOTICE**

Filter networks and transient protection clamps are used in the hardware to prevent damage caused by high peak voltage transients, radio frequency interference (RFI), and electromagnetic interference (EMI). These protective components can be damaged by application of the ANSI/IEEE C37.90 specified test voltage for longer than the specified minute.

### 3.3.3 Control power

**NOTICE**

Power supplied to the relay must be connected to the matching power supply range of the relay. If incorrect voltage is applied or voltage is applied to the wrong terminals, damage can occur.

The G30, like almost all electronic relays, contains electrolytic capacitors. These capacitors are well-known to deteriorate over time if voltage is not applied periodically. Deterioration can be avoided by powering up the relay at least once a year.

The power supply module is ordered with one of two possible voltage ranges, and the G30 can be ordered with or without a redundant power supply module option. Each range has a dedicated input connection for proper operation. The ranges are as follows (see the Specifications section of chapter 2 for details):

- Low (LO) range – 24 to 48 V (DC only) nominal
- High (HI) range – 125 to 250 V nominal

The power supply module provides power to the relay and supplies power for dry contact input connections.

The power supply module provides 48 V DC power for dry contact input connections and a critical failure relay (see the Typical Wiring Diagram earlier). The critical failure relay is a form-C device that is energized once control power is applied and the relay has successfully booted up with no critical self-test failures. If ongoing self-test diagnostic checks detect a critical failure (see the Self-Test Errors section in chapter 7) or control power is lost, the relay de-energizes.

**WARNING**

**Connect all wires at be back of a UR before connecting to power, else death or serious injury can result from electrical shock.**

To connect power to the relay:

1. On the power supply module in the first slot, slot B, on the back of the device, connect the three wires to the terminals, or connect two to the terminals and the third to the ground screw. 14 gauge stranded wire with disconnect devices is recommended. Use 13 inch-pounds torque. Connect all wires to the relay before turning on power.

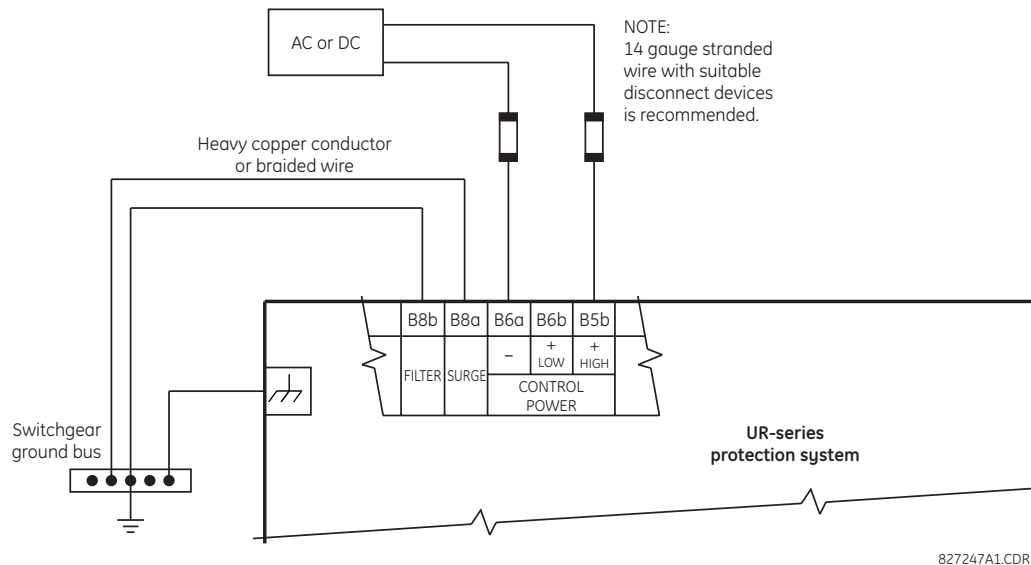
For high-reliability systems, the G30 has a redundant option in which two G30 power supplies are placed in parallel on the bus. If one of the power supplies becomes faulted, the second power supply assumes the full load of the relay without any interruptions. Each power supply has a green LED on the front of the module to indicate that it is functional. The critical fail relay of the module also indicates a faulted power supply.

An LED on the front of the control power module shows the status of the power supply, as outlined in the table.

**Table 3-2: Power supply LED on module**

LED indication	Power supply
Continuous on	OK
On/off cycling	Failure
Off	Failure or no power

**Figure 3-17: Control power connection**



### 3.3.3.1 Non-volatile data storage

Non-volatile data is temporary data required after a power cycle for relay state, such as latch status before reboot. The relay saves this data in non-volatile storage every two minutes or when a state change occurs.

If a state change occurs just before a power down (less than two minutes) and the relay power is cycled, some temporary data can be saved and the prior state is retained at power up. Otherwise, a two-minute powered on period after a state change ensures that all temporary state changes required after reboot have been saved. A command also is available to initiate saving of data in the compact flash memory using **Commands > Relay Maintenance > Save Volatile Data**.

### 3.3.4 CT/VT modules

The CT and VT inputs are analog current transformer and voltage transformer signals used to monitor AC power lines. The UR-series relays support 1 A and 5 A CTs.

A CT/VT module can have current or voltage inputs on channels 1 through 4 inclusive, or channels 5 through 8 inclusive. Channels 1 and 5 are intended for connection to phase A, and are labelled as such in the relay. Likewise, channels 2 and 6 are intended for connection to phase B, and channels 3 and 7 are intended for connection to phase C.

Channels 4 and 8 are intended for connection to a single-phase source. For voltage inputs, these channels are labelled as auxiliary voltage (VX). For current inputs, these channels are intended for connection to a CT between system neutral and ground, and are labelled as ground current (IG).

**NOTICE**

Verify that the connection made to the relay terminals for nominal current of 1 A or 5 A matches the secondary rating of the connected CTs. Unmatched CTs can result in equipment damage or inadequate protection.

To connect to the module, size 12 American Wire Gauge (AWG) is used commonly; the maximum size is 10 AWG.

CT/VT modules can be ordered with a standard ground current input that is the same as the phase current input. Each AC current input has an isolating transformer and an automatic shorting mechanism that shorts the input when the module is withdrawn from the chassis. There are no internal ground connections on the current inputs. Current transformers with 1 to 50000 A primaries and 1 A or 5 A secondaries can be used.

CT/VT modules with a sensitive ground input are also available. The ground CT input of the sensitive ground modules is 10 times more sensitive than the ground CT input of standard CT/VT modules. However, the phase CT inputs and phase VT inputs are the same as those of regular CT/VT modules.

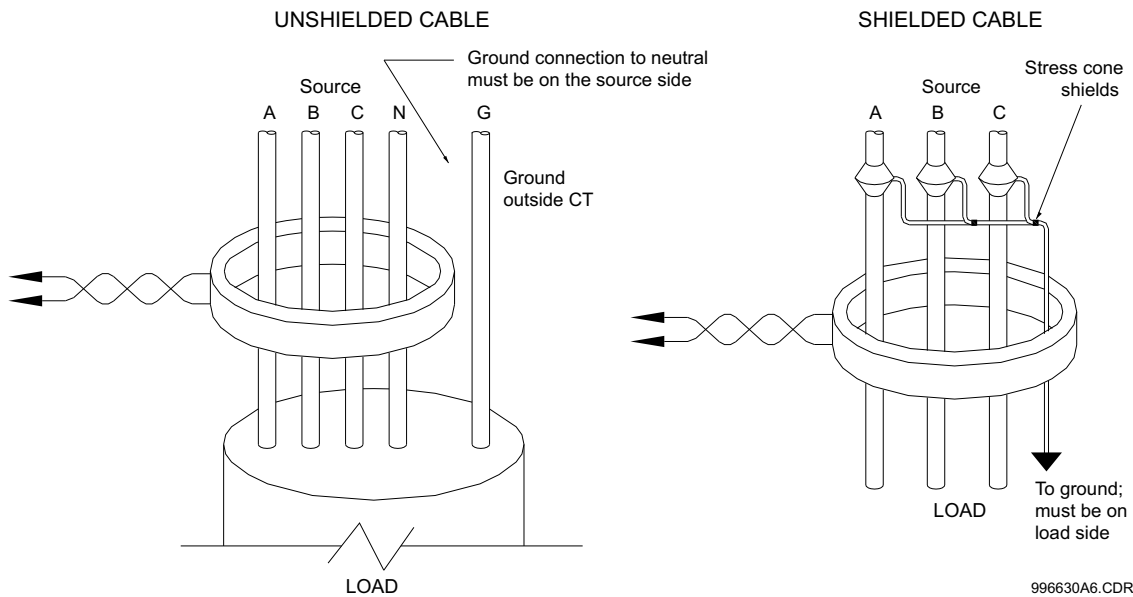
These modules have enhanced diagnostics that can detect automatically CT/VT hardware failure and take the relay out of service.

CT connections for both ABC and ACB phase rotations are identical, as shown in the Typical Wiring Diagram.

The exact placement of a zero-sequence core balance CT to detect ground fault current is shown as follows. Twisted-pair cabling on the zero-sequence CT is recommended.

3

**Figure 3-18: Zero-sequence core balance CT installation**

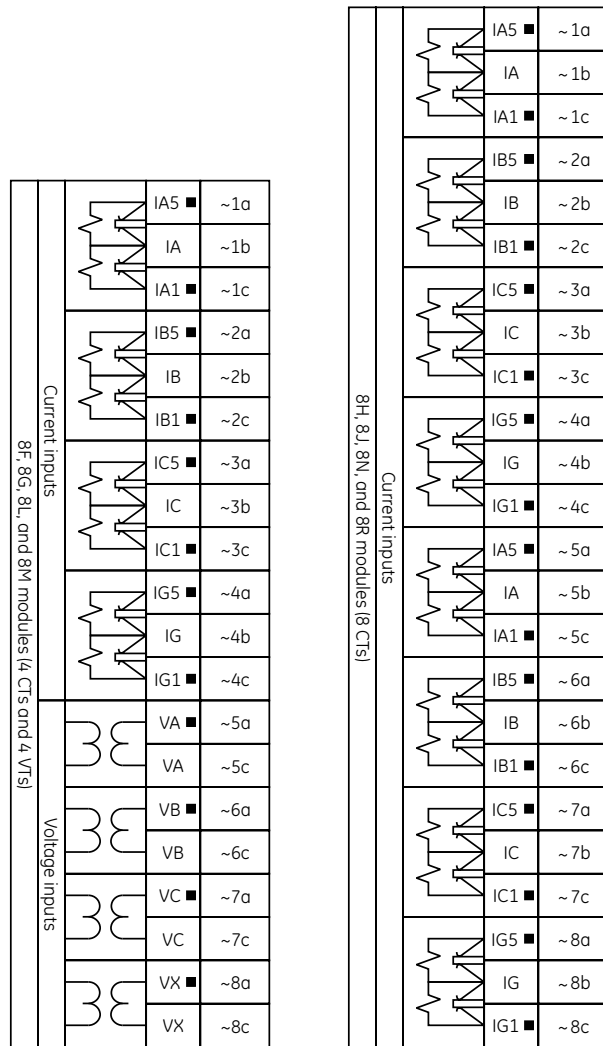


The phase voltage channels are used for most metering and protection purposes. The auxiliary voltage channel is used as input for the synchrocheck and volts-per-hertz features, which are optional features for some UR models.



Substitute the tilde “~” symbol with the slot position of the module in the following figure.

Figure 3-19: CT/VT module wiring



842766A4.CDR

### 3.3.5 Process bus modules

The G30 can be ordered with a process bus interface module. The module interfaces with the HardFiber Process Bus System, or HardFiber Brick, allowing bidirectional IEC 61850 fiber-optic communications with up to eight HardFiber Bricks. The HardFiber system integrates seamlessly with the existing UR-series applications, including protection functions, FlexLogic, metering, and communications.

This process bus system offers the following benefits:

- Reduces labor associated with design, installation, and testing of protection and control applications using the UR by reducing the number of individual copper terminations
- Integrates seamlessly with existing UR applications, since the IEC 61850 process bus interface module replaces the traditional CT/VT modules
- Communicates using open standard IEC 61850 messaging

For details on the HardFiber system, see its Instruction Manual.

### 3.3.6 Contact inputs and outputs

Nearly all contact input/output modules have 24 terminal connections. The connections are arranged typically as three terminals per row, with eight rows in total. A given row of three terminals can be used for the outputs of one relay. For example, for form-C relay outputs, the terminals connect to the normally open (NO), normally closed (NC), and common contacts of the relay. For a form-A output, there are options of using current or voltage detection for feature supervision, depending on the module ordered. The terminal configuration for contact inputs is different for the two applications.

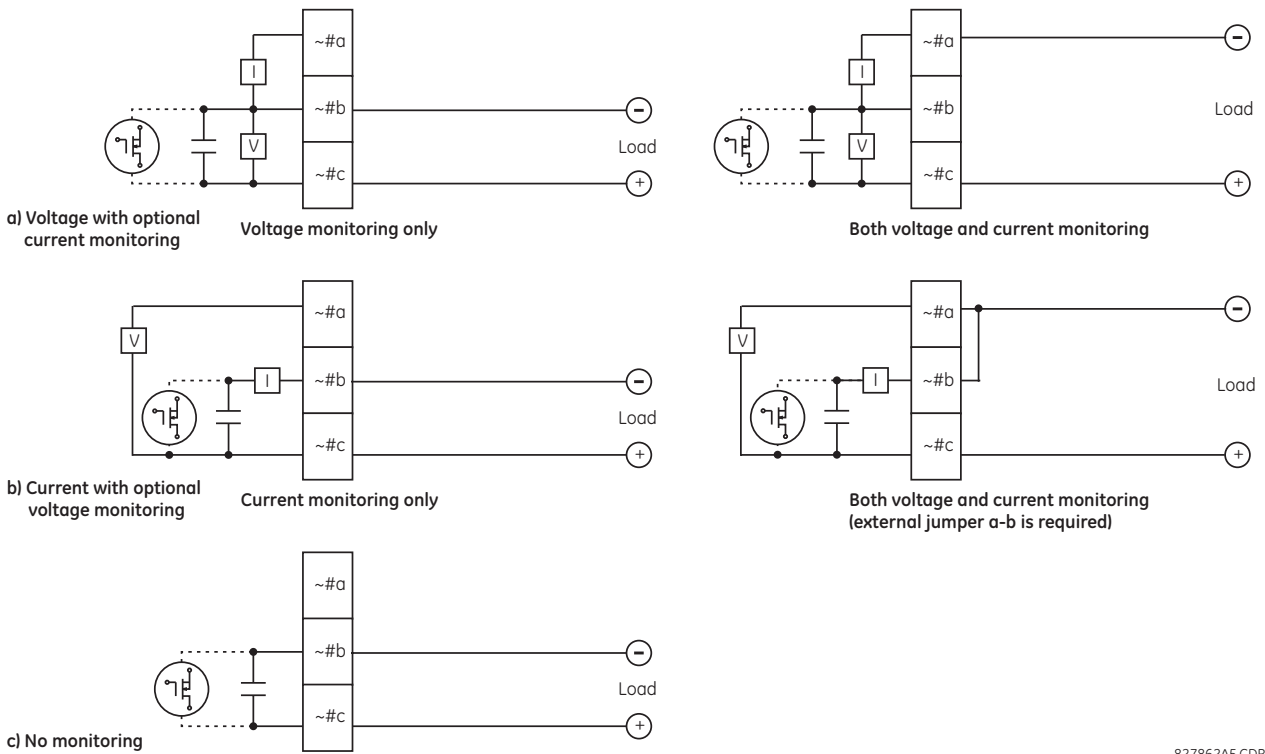
The contact inputs are grouped with a common return. The input/output modules have three versions of grouping: four inputs per common return, five inputs per common return on a high-density module, and two inputs per common return. When a contact input/output module is ordered, four inputs per common is used. If the inputs must be isolated per row, then two inputs per common return are selected (4D module). If the space limitation in the relay requires use of a high-density input module (6W), five inputs share one common return and the module has six banks of inputs.

The tables and diagrams that follow illustrate the module types (6A and so on) and contact arrangements that can be ordered for the relay. Since an entire row is used for a single contact output, the name is assigned using the module slot position and row number. However, since there are two contact inputs per row, these names are assigned by module slot position, row number, and column position.

Some form-A / solid-state relay outputs include circuits to monitor the DC voltage across the output contact when it is open, and the DC current through the output contact when it is closed. Each of the monitors contains a level detector whose output is set to logic "On = 1" when the current in the circuit is above the threshold setting. The voltage monitor is set to "On = 1" when there is a voltage across open contact (the detector allows a current of about 1 to 2.5 mA), and the current monitor is set to "On = 1" when the current flowing through the closed contact exceeds about 80 to 100 mA. The voltage monitor is intended to check the health of the overall trip circuit, and the current monitor can be used to seal-in the output contact until an external contact has interrupted current flow. If enabled, the current monitoring can be used as a seal-in signal to ensure that the form-A contact does not attempt to break the energized inductive coil circuit and weld the output contacts.

Block diagrams are shown as follows for form-A and solid-state relay outputs with optional voltage monitor, optional current monitor, and with no monitoring. The actual values shown for contact output 1 are the same for all contact outputs. Form-A contact output with or without a current or voltage monitoring option is not polarity sensitive. The polarity shown in the figure is required for solid-state contact output connection.

Figure 3-20: Form-A and solid-state contact outputs with voltage and current monitoring



827862A5.CDR

The operation of voltage and current monitors is reflected with the corresponding FlexLogic operands (`CONT OP # VON`, `CONT OP # VOFF`, and `CONT OP # ION`) that can be used in protection, control, and alarm logic. The typical application of the voltage monitor is breaker trip circuit integrity monitoring; a typical application of the current monitor is seal-in of the control command.

See the Digital Elements section of chapter 5 for an example of how form-A and solid-state relay contacts can be applied for breaker trip circuit integrity monitoring.

**WARNING** Consider relay contacts unsafe to touch when the unit is energized. Death or serious injury can result from touching live relay contacts.

**USE OF FORM-A AND SOLID-STATE RELAY OUTPUTS IN HIGH-IMPEDANCE CIRCUITS**

**NOTE** For form-A and solid-state relay output contacts internally equipped with a voltage measuring circuit across the contact, the circuit has an impedance that can cause a problem when used in conjunction with external high-input impedance monitoring equipment, such as modern relay test set trigger circuits. These monitoring circuits can continue to read the form-A contact as being closed after it has closed and subsequently opened, when measured as an impedance.

The solution is to use the voltage measuring trigger input of the relay test set, and connect the form-A contact through a voltage-dropping resistor to a DC voltage source. If the 48 V DC output of the power supply is used as a source, a 500 Ω, 10 W resistor is appropriate. In this configuration, the voltage across either the form-A contact or the resistor can be used to monitor the state of the output.

**NOTE** Where a tilde “~” symbol appears, substitute the slot position of the module. Where a number sign “#” appears, substitute the contact number.

**NOTICE**

When current monitoring is used to seal-in the form-A and solid-state relay contact outputs, give the FlexLogic operand driving the contact output a reset delay of 10 ms to prevent damage of the output contact (in situations when the element initiating the contact output is bouncing, at values in the region of the pickup value).

For high-density input/output modules 6W and 6X, use the following guidelines to connect. The new I/O modules use pin type terminal blocks instead of the current ring type. The new terminals are required to achieve higher I/O count per module.

- 12 to 24 AWG (3.3 mm<sup>2</sup> to 0.2 mm<sup>2</sup>), single wire termination
- 16 to 24 AWG (1.31 mm<sup>2</sup> to 0.2 mm<sup>2</sup>), multiple wire termination with matching wire sizes and stranding. Two wires maximum per circuit.
- Suggested wiring screw tightening torque is a minimum 4.43 in-lb (0.5 Nm) and maximum 5.31 in-lb (0.6 Nm)
- Minimum suggested temperature rating for the conductors is 75°C
- Wire type: copper

**Table 3-3: Contact input and output module assignments**

~6A module	
Terminal assignment	Output or input
~1	Form-A
~2	Form-A
~3	Form-C
~4	Form-C
~5a, ~5c	2 Inputs
~6a, ~6c	2 Inputs
~7a, ~7c	2 Inputs
~8a, ~8c	2 Inputs

~6B module	
Terminal assignment	Output or input
~1	Form-A
~2	Form-A
~3	Form-C
~4	Form-C
~5	Form-C
~6	Form-C
~7a, ~7c	2 Inputs
~8a, ~8c	2 Inputs

~6C module	
Terminal assignment	Output
~1	Form-C
~2	Form-C
~3	Form-C
~4	Form-C
~5	Form-C
~6	Form-C
~7	Form-C
~8	Form-C

~6D module	
Terminal assignment	Output
~1a, ~1c	2 Inputs
~2a, ~2c	2 Inputs
~3a, ~3c	2 Inputs
~4a, ~4c	2 Inputs
~5a, ~5c	2 Inputs
~6a, ~6c	2 Inputs
~7a, ~7c	2 Inputs
~8a, ~8c	2 Inputs

~6E module	
Terminal assignment	Output or input
~1	Form-C
~2	Form-C
~3	Form-C
~4	Form-C
~5a, ~5c	2 Inputs
~6a, ~6c	2 Inputs
~7a, ~7c	2 Inputs
~8a, ~8c	2 Inputs

~6F module	
Terminal assignment	Output
~1	Fast Form-C
~2	Fast Form-C
~3	Fast Form-C
~4	Fast Form-C
~5	Fast Form-C
~6	Fast Form-C
~7	Fast Form-C
~8	Fast Form-C

~6G module	
Terminal assignment	Output or input
~1	Form-A
~2	Form-A
~3	Form-A
~4	Form-A
~5a, ~5c	2 Inputs
~6a, ~6c	2 Inputs
~7a, ~7c	2 Inputs
~8a, ~8c	2 Inputs

~6H module	
Terminal assignment	Output or input
~1	Form-A
~2	Form-A
~3	Form-A
~4	Form-A
~5	Form-A
~6	Form-A
~7a, ~7c	2 Inputs
~8a, ~8c	2 Inputs

~6K module	
Terminal assignment	Output
~1	Form-C
~2	Form-C
~3	Form-C
~4	Form-C
~5	Fast Form-C

~6L module	
Terminal assignment	Output or input
~1	Form-A
~2	Form-A
~3	Form-C
~4	Form-C
~5a, ~5c	2 Inputs

~6M module	
Terminal assignment	Output or input
~1	Form-A
~2	Form-A
~3	Form-C
~4	Form-C
~5	Form-C

~6N module	
Terminal assignment	Output or input
~1	Form-A
~2	Form-A
~3	Form-A
~4	Form-A
~5a, ~5c	2 Inputs



~6K module	
Terminal assignment	Output
~6	Fast Form-C
~7	Fast Form-C
~8	Fast Form-C

~6L module	
Terminal assignment	Output or input
~6a, ~6c	2 Inputs
~7a, ~7c	2 Inputs
~8a, ~8c	2 Inputs

~6M module	
Terminal assignment	Output or input
~6	Form-C
~7a, ~7c	2 Inputs
~8a, ~8c	2 Inputs

~6N module	
Terminal assignment	Output or input
~6a, ~6c	2 Inputs
~7a, ~7c	2 Inputs
~8a, ~8c	2 Inputs

~6P module	
Terminal assignment	Output or input
~1	Form-A
~2	Form-A
~3	Form-A
~4	Form-A
~5	Form-A
~6	Form-A
~7a, ~7c	2 Inputs
~8a, ~8c	2 Inputs

~6R module	
Terminal assignment	Output or input
~1	Form-A
~2	Form-A
~3	Form-C
~4	Form-C
~5a, ~5c	2 Inputs
~6a, ~6c	2 Inputs
~7a, ~7c	2 Inputs
~8a, ~8c	2 Inputs

~6S module	
Terminal assignment	Output or input
~1	Form-A
~2	Form-A
~3	Form-C
~4	Form-C
~5	Form-C
~6	Form-C
~7a, ~7c	2 Inputs
~8a, ~8c	2 Inputs

~6T module	
Terminal assignment	Output or input
~1	Form-A
~2	Form-A
~3	Form-A
~4	Form-A
~5a, ~5c	2 Inputs
~6a, ~6c	2 Inputs
~7a, ~7c	2 Inputs
~8a, ~8c	2 Inputs

~6U module	
Terminal assignment	Output or input
~1	Form-A
~2	Form-A
~3	Form-A
~4	Form-A
~5	Form-A
~6	Form-A
~7a, ~7c	2 Inputs
~8a, ~8c	2 Inputs
---	---
---	---
---	---
---	---
---	---
---	---
---	---
---	---
---	---
---	---
---	---
---	---

~6V module	
Terminal assignment	Output or input
~1	Form-A
~2	Form-A
~3	Form-C
~4	2 Outputs
~5a, ~5c	2 Inputs
~6a, ~6c	2 Inputs
~7a, ~7c	2 Inputs
~8a, ~8c	2 Inputs
---	---
---	---
---	---
---	---
---	---
---	---
---	---
---	---
---	---
---	---
---	---

~6W module	
Terminal assignment	Output or input
~1a - ~2a	Output
~3a - ~4a	Output
~5a - ~6a	Output
~7a - ~8a	Output
~9a - ~10a	Output
~11a - ~12a	Output
~13a - ~14a	Output
~15a - ~16a	Output
~17a - ~18a	Output
~1b - ~2b	Output
~3b - ~4b	Output
~5b - ~6b	Output
~7b - ~8b	Output
~9b - ~10b	Output
~11b - ~12b	Output
~13b - ~14b	Output
~15b - ~16b	Output
~17b - ~18b	Output

6X module	
Terminal assignment	Output or input
~1a, ~1b	2 Inputs
~2a, ~2b	2 Inputs
~3a, ~3b	2 Inputs
~4a, ~4b	2 Inputs
~5a, ~5b	2 Inputs
~7a, ~7b	2 Inputs
~8a, ~8b	2 Inputs
~9a, ~9b	2 Inputs
~10a, ~10b	2 Inputs
~11a, ~11b	2 Inputs
~13a, ~13b	2 Inputs
~14a, ~14b	2 Inputs
~15a, ~15b	2 Inputs
~16a, ~16b	2 Inputs
~17a, ~17b	2 Inputs
---	---
---	---
---	---

~67 module	
Terminal assignment	Output
~1	Form-A
~2	Form-A

~4A module	
Terminal assignment	Output
~1	Not Used
~2	Solid-State

~4B module	
Terminal assignment	Output
~1	Not Used
~2	Solid-State

~4C module	
Terminal assignment	Output
~1	Not Used
~2	Solid-State

~67 module	
Terminal assignment	Output
~3	Form-A
~4	Form-A
~5	Form-A
~6	Form-A
~7	Form-A
~8	Form-A

~4A module	
Terminal assignment	Output
~3	Not Used
~4	Solid-State
~5	Not Used
~6	Solid-State
~7	Not Used
~8	Solid-State

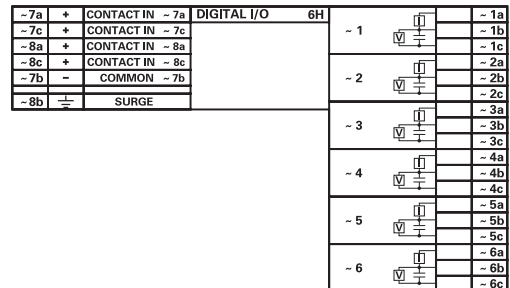
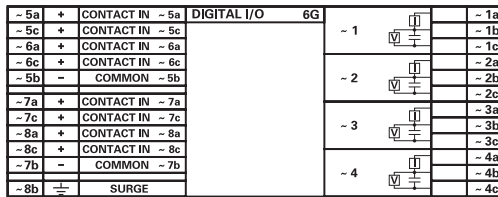
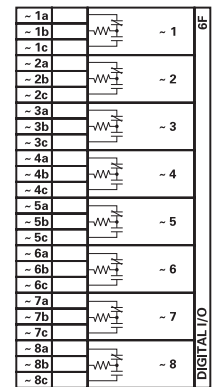
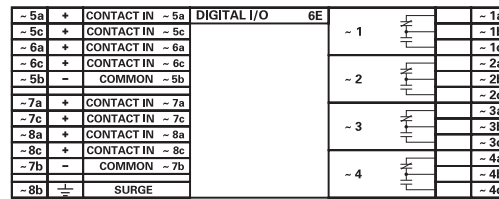
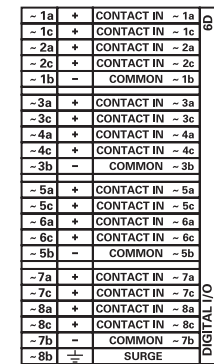
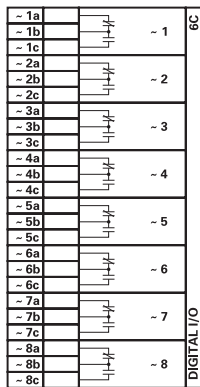
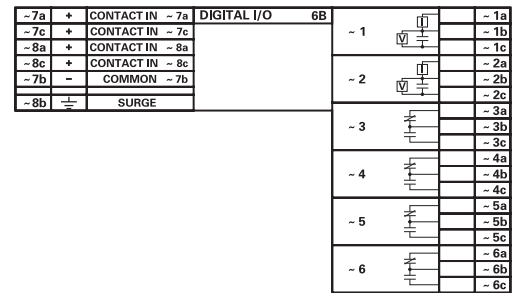
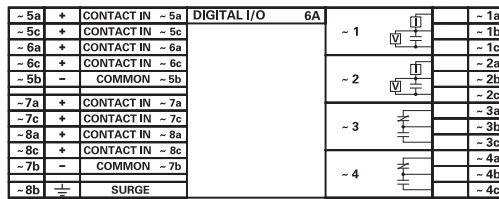
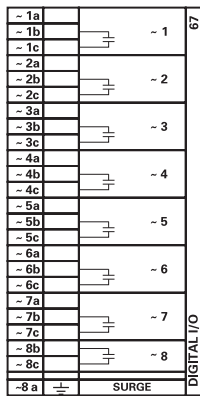
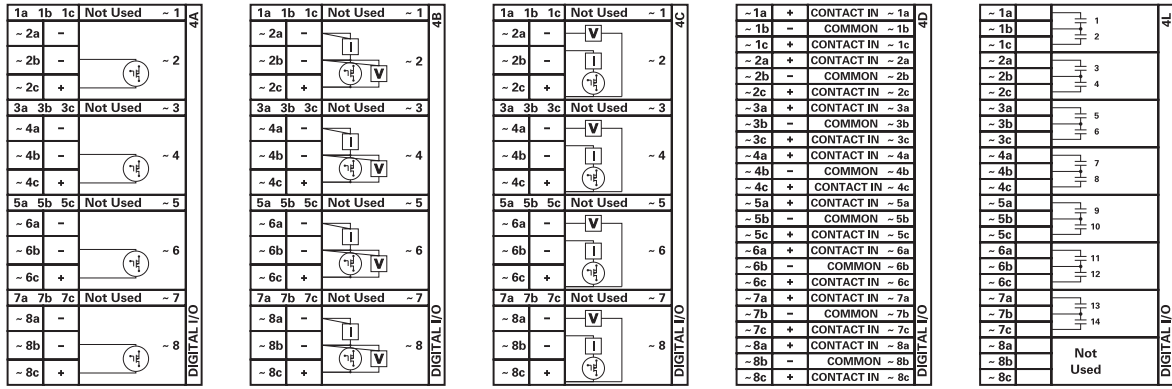
~4B module	
Terminal assignment	Output
~3	Not Used
~4	Solid-State
~5	Not Used
~6	Solid-State
~7	Not Used
~8	Solid-State

~4C module	
Terminal assignment	Output
~3	Not Used
~4	Solid-State
~5	Not Used
~6	Solid-State
~7	Not Used
~8	Solid-State

~4D module	
Terminal assignment	Output
~1a, ~1c	2 Inputs
~2a, ~2c	2 Inputs
~3a, ~3c	2 Inputs
~4a, ~4c	2 Inputs
~5a, ~5c	2 Inputs
~6a, ~6c	2 Inputs
~7a, ~7c	2 Inputs
~8a, ~8c	2 Inputs

~4L module	
Terminal assignment	Output
~1	2 Outputs
~2	2 Outputs
~3	2 Outputs
~4	2 Outputs
~5	2 Outputs
~6	2 Outputs
~7	2 Outputs
~8	Not Used

Figure 3-21: Contact input and output module wiring (Sheet 1 of 3)



842762A4.CDR





Figure 3-23: Contact input and output module wiring (Sheet 3 of 3)

DIGITAL I/O				6W			
~1b	+	CONTACT IN ~16	CONTACT IN ~1	+	~1a		
~2b	+	CONTACT IN ~17	CONTACT IN ~2	+	~2a		
~3b	+	CONTACT IN ~18	CONTACT IN ~3	+	~3a		
~4b	+	CONTACT IN ~19	CONTACT IN ~4	+	~4a		
~5b	+	CONTACT IN ~20	CONTACT IN ~5	+	~5a		
~6b		COMMON	COMMON		~6a		
~7b	+	CONTACT IN ~21	CONTACT IN ~8	+	~7a		
~8b	+	CONTACT IN ~22	CONTACT IN ~7	+	~8a		
~9b	+	CONTACT IN ~23	CONTACT IN ~8	+	~9a		
~10b	+	CONTACT IN ~24	CONTACT IN ~9	+	~10a		
~11b	+	CONTACT IN ~25	CONTACT IN ~10	+	~11a		
~12b		COMMON	COMMON		~12a		
~13b	+	CONTACT IN ~26	CONTACT IN ~11	+	~13a		
~14b	+	CONTACT IN ~27	CONTACT IN ~12	+	~14a		
~15b	+	CONTACT IN ~28	CONTACT IN ~13	+	~15a		
~16b	+	CONTACT IN ~29	CONTACT IN ~14	+	~16a		
~17b	+	CONTACT IN ~30	CONTACT IN ~15	+	~17a		
~18b		COMMON	COMMON		~18a		

DIGITAL I/O				6X			
~1b			~10	-	1		~1a
~2b					2		~2a
~3b			~11	-	2		~3a
~4b					3		~4a
~5b			~12	-	3		~5a
~6b					4		~6a
~7b			~13	-	4		~7a
~8b					5		~8a
~9b			~14	-	5		~9a
~10b					6		~10a
~11b			~15	-	6		~11a
~12b					7		~12a
~13b			~16	-	7		~13a
~14b					8		~14a
~15b			~17	-	8		~15a
~16b					9		~16a
~17b			~18	-	9		~17a
~18b							~18a

859759A1.CDR

**NOTICE**

For proper functionality, observe the polarity shown in the figures for all contact input and output connections.

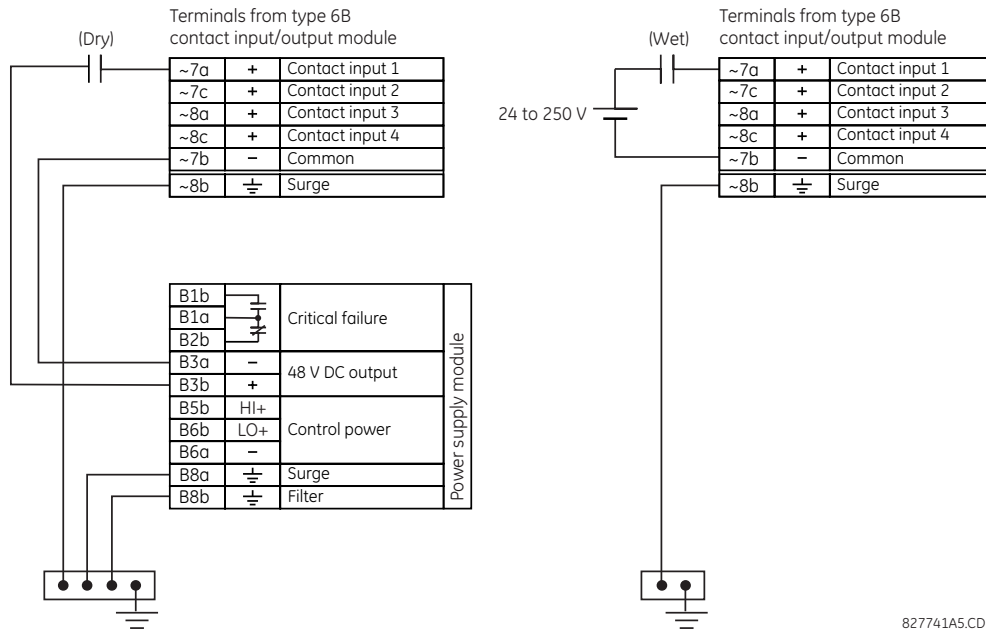
3.3.6.1 Contact inputs

A dry contact has one side connected to terminal B3b. This is the positive 48 V DC voltage rail supplied by the power supply module. The other side of the dry contact is connected to the required contact input terminal. Each contact input group has its own common (negative) terminal that must be connected to the DC negative terminal (B3a) of the power supply module. When a dry contact closes, a current of 1 to 3 mA flows through the associated circuit.

A wet contact has one side connected to the positive terminal of an external DC power supply. The other side of this contact is connected to the required contact input terminal. If a wet contact is used, then the negative side of the external source must be connected to the relay common (negative) terminal of each contact group. The maximum external source voltage for this arrangement is 300 V DC.

The voltage threshold at which each group of four contact inputs detects a closed contact input is programmable as 17 V DC for 24 V sources, 33 V DC for 48 V sources, 84 V DC for 110 to 125 V sources, and 166 V DC for 250 V sources.

Figure 3-24: Dry and wet contact input connections



827741A5.CDR



Where a tilde “~” symbol appears, substitute the slot position of the module.

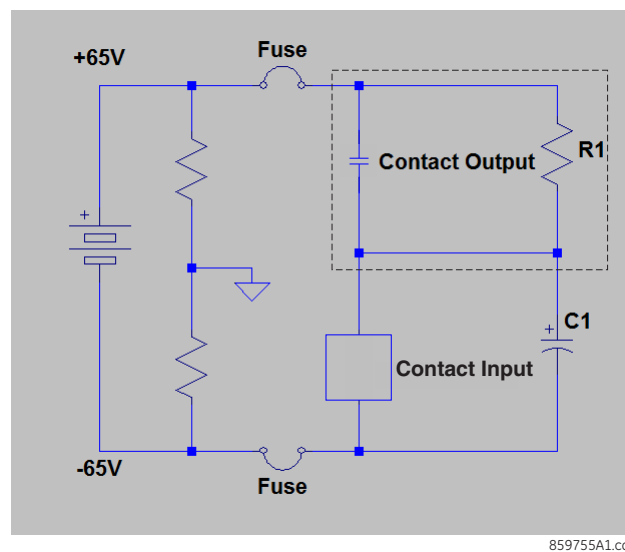
There is no provision in the relay to detect a DC ground fault on 48 V DC control power external output. We recommend using an external DC supply.

### 3.3.6.2 General application considerations

Contacts outputs of protective relays, auxiliary contacts from breakers, disconnectors and other devices are connected generally to contacts inputs of protective relays. In some situations, the contact outputs of some protective relays can have high impedance connected across it. When such a contact output is connected across a G30 contact input, it can spuriously operate the G30 input even when the output is open, if there is a substantial distributed capacitance (represented by C1) present in the wiring between the output and the G30 input, and the debounce time setting in the G30 relay is low enough. This false assertion of the contact input, when there is inadvertent ground present at the DC positive terminal, can be prevented by inserting a resistor across the G30 input.

The following figure shows a typical DC circuit, with battery ground detection, of contact input. The contact output has parallel impedance across it (represented by R1).

Figure 3-25: Typical contact input DC circuit



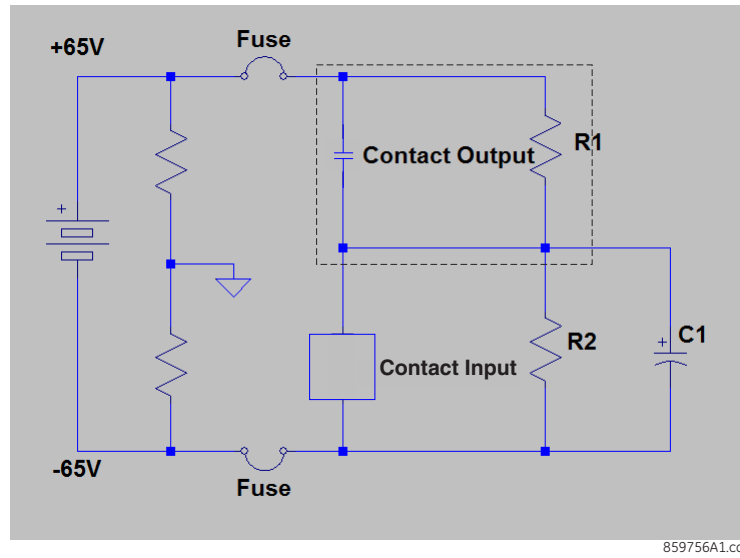
859755A1.cdr

The presence of the impedance path (R1) across the contact output allows the stray (distributed) capacitance C1 to charge as shown, thus developing a voltage across the contact input enough to momentarily operate the input while the capacitance discharges in the presence of DC ground on the positive terminal of the battery.

The duration of the discharge depends on the value of the distributed capacitance, the initial voltage of the distributed capacitance, and the input impedance of the contact input. If the duration is greater than the debounce time setting, then the contact input operates.

The application example that follows describes how to mitigate this issue by connecting a resistor across the contact input, as shown in the next figure, or by adjusting the debounce time setting to a value greater than the discharge time to prevent spurious operation of the contact input only if the voltage (with output open) across the contact input due to trickle current is less than the threshold voltage. This operation of contact inputs also can be prevented by using the Auto-Burnish contact inputs or contact inputs with active impedance.

Figure 3-26: Contact input connected to a contact output with resistor (R2) across the input



**Application example**

This example is for illustrative purposes only and the calculations present the worst-case scenario. In practice, the value of debounce time can be lower.

Contact input ON state impedance used in the calculation of the discharge period is based on the following table.

**Table 3-4: Discharge period**

Battery voltage (V)	Input impedance (kΩ)
130	50
250	97

Debounce time setting = 2 ms

Assume a stray capacitance of 0.1 μF.

Assume an initial voltage across the stray capacitance "Vinitial" = 19 V (Vthreshold - 65 V), where Vthreshold = 84 V. The initial voltage Vinitial depends on values of impedance of R1 and contact inputs when the contact input is OFF (non-activated state).

Therefore, discharge time constant (τ) = 50 kΩ \* 0.1 μF = 5 ms.

Discharge period t is calculated from the following equation:

$$V_{threshold} = (V_{batt} - V_{initial}) * e^{(-t/\tau)}$$

$$84 = -149 * e^{(t/0.005)}$$

Eq. 3-1

$$T = -0.005 * \ln(84/149) = 0.0029 \text{ s}$$

Therefore, in this example the contact inputs operate.

To prevent this operation, the debounce time must be increased to 4 ms (set debounce time as per the following table) or insert a resistor less than or equal to "R" as calculated later.

**Table 3-5: Typical debounce time setting**

Stray capacitance (μF)	Battery voltage (V)	Debounce time (ms)
0.05	130	2
0.1	130	4
0.2	130	6
0.05	250	3

Stray capacitance (µF)	Battery voltage (V)	Debounce time (ms)
0.1	250	6 *
0.2	250	11

\* Default debounce time on contact inputs is 6 ms.

The value of this resistor "R" is calculated as follows:

1. Determine the minimum voltage (V threshold) required to turn on the input. This is determined by direct measurement or referenced in the input specifications.
2. Calculate the resistance necessary to limit the voltage to 1/3 V threshold (when the contact is OFF, the non-activated state) as follows:

$$R = (V_{\text{threshold}} / 3) / (2 \text{ mA}) \tag{Eq. 3-2}$$

The 2 mA current is used in case the contact input is connected across the GE Form A contact output with voltage monitoring. Otherwise use the amperage of the active circuit connected to the contact input when its contact output is open and the voltage across the contact input is third trigger threshold to calculate the resistor value.

3. When the contact is ON (operate state), the battery voltage appears across the resistor. The wattage rating of the resistor is then:

$$PR = 1.3 * (V_{\text{batt}})^2 / R \text{ Watts} \tag{Eq. 3-3}$$

4. Applying the following equation to our example:

$$R = 84 \text{ V} / 3 * (1 / 2 \text{ mA}) = 14 \text{ k}\Omega$$

$$PR = 1.57 \text{ Watts} \tag{Eq. 3-4}$$

5. Calculating the voltage across the contact input with the Burden Resistor, Voltage across the contact Input:

$$V_{\text{resistor}} = 2 \text{ mA} * 14 \text{ Kohm} = 28 \text{ V}$$

$$V_{\text{resistor}} < \text{contact input threshold (84 V)} \tag{Eq. 3-5}$$

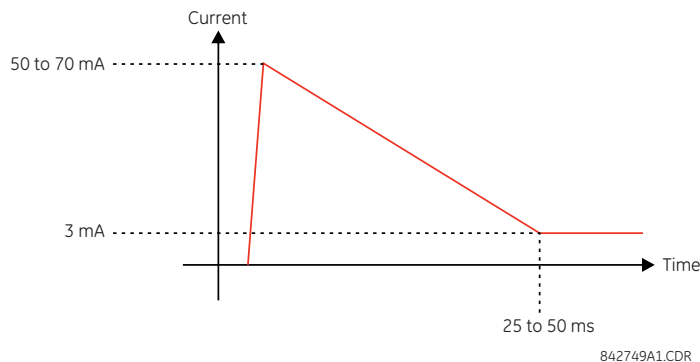
In conclusion, in this example, the contact input does NOT operate falsely with the Burden Resistor across its input AND when a battery ground is present.

### 3.3.6.3 Use of contact inputs with auto-burnishing

The contact inputs sense a change of state of the external device contact based on the measured current. When external devices are located in a harsh industrial environment (either outdoor or indoor), their contacts can be exposed to various types of contamination. Normally, there is a thin film of insulating sulfidation, oxidation, or contaminates on the surface of the contacts, sometimes making it difficult or impossible to detect a change of state. This film must be removed to establish circuit continuity — an impulse of higher than normal current can accomplish this.

The contact inputs with auto-burnish create a high current impulse when the threshold is reached to burn off this oxidation layer as a maintenance to the contacts. Afterwards the contact input current is reduced to a steady-state current. The impulse has a five-second delay after a contact input changes state.

Figure 3-27: Current through contact inputs with auto-burnishing



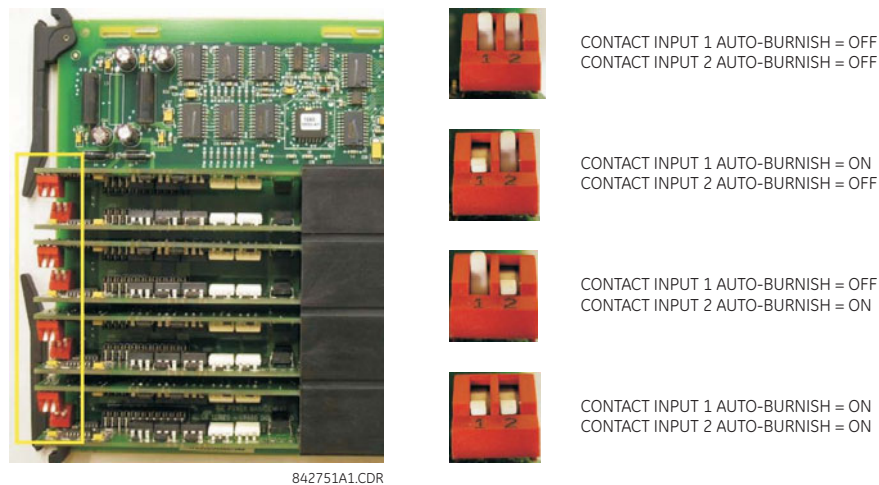


Regular contact inputs limit current to less than 3 mA to reduce station battery burden. In contrast, contact inputs with auto-burnishing allow currents up to 50 to 70 mA at the first instance when the change of state is sensed. Then, within 25 to 50 ms, this current is slowly reduced to 3 mA as indicated. The 50 to 70 mA peak current burns any film on the contacts, allowing for proper sensing of state changes. If the external device contact is bouncing, the auto-burnishing starts when external device contact bouncing is over.

Another important difference between the auto-burnishing input module and the regular input modules is that only two contact inputs have common ground, as opposed to four contact inputs sharing one common ground (see the Contact Input and Output Module Wiring diagrams). This is beneficial when connecting contact inputs to separate voltage sources. Consequently, the threshold voltage setting is also defined per group of two contact inputs.

The auto-burnish feature can be disabled or enabled using the DIP switches found on each daughter card. There is a DIP switch for each contact, for a total of 16 inputs.

Figure 3-28: Auto-burnish DIP switches



The auto-burnish circuitry has an internal fuse for safety purposes. During regular maintenance, check the auto-burnish functionality using an oscilloscope.

### 3.3.6.4 Use of contact inputs with active impedance

Contact inputs can be susceptible to parasitic capacitance, caused by long cable runs affected by switching surges from external circuits. This can result in inadvertent activation of contact inputs with the external contact open. In this case, GE recommends using the contact I/O module with active impedance circuit.

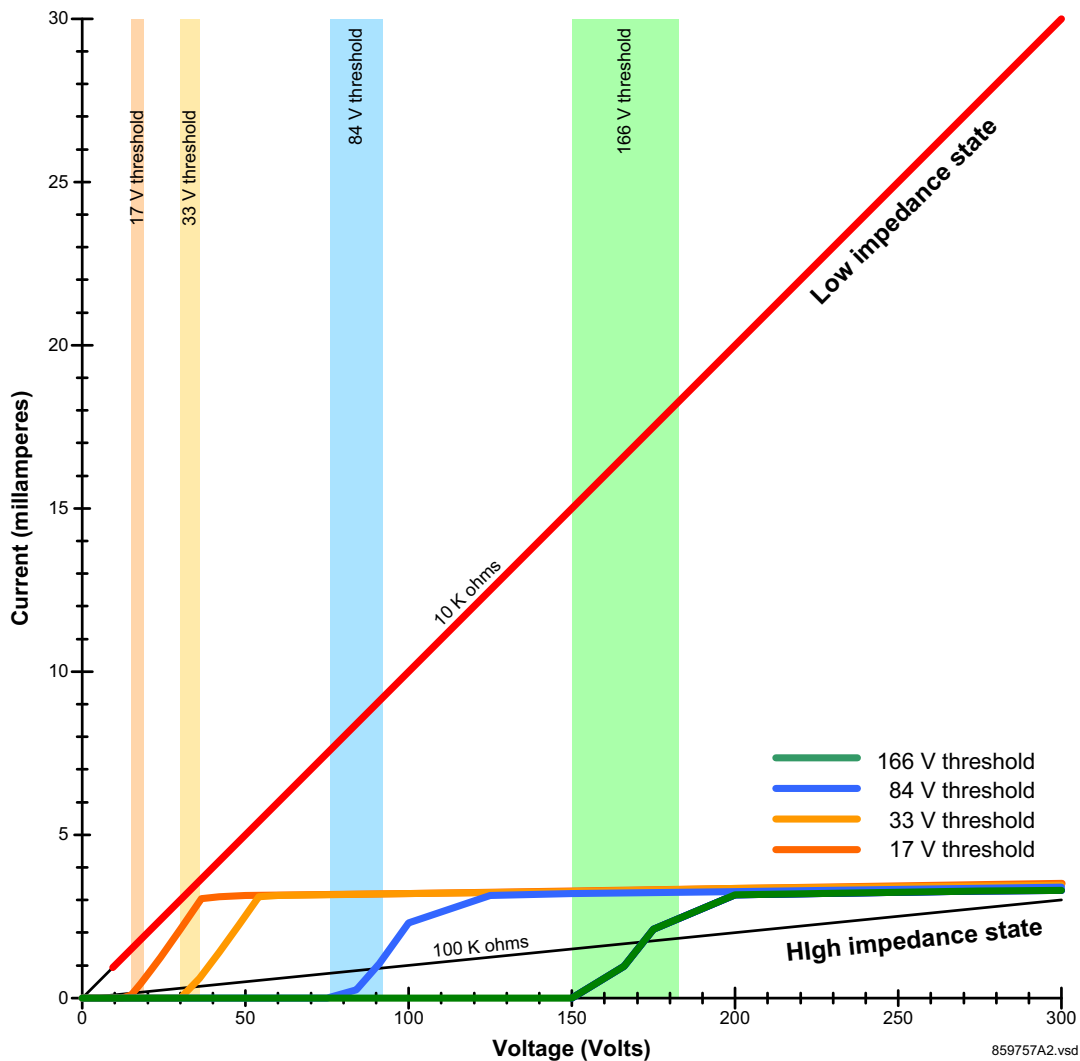
Active impedance contact input can tolerate external cable capacitance of up to 0.2  $\mu\text{F}$ , without entering the ON state for more than 2 ms. The contact input debounce time can still be set above 2 ms for added security to prevent contact input activations caused by external transient ON states.

An active impedance contact input is normally in Low impedance mode during OFF contact state (non-activated condition). During Low impedance state, contact input impedance is maintained at 10 K Ohms impedance to allow fast discharge of the stray capacitance of the long cables.

When the contact input voltage exceeds the set threshold, active impedance maintains 10 K Ohms impedance. If voltage starts rapidly decreasing, this indicates that stray capacitance is being discharged through the contact input. If, however, voltage stabilizes above the set threshold, the input impedance is switched to High impedance mode of 100 K Ohms. This value reduces the input current to <3 mA, and contact input switches to the ON state (operated state).

The figure shows the active impedance contact input V-I characteristic. Different thresholds with their corresponding characteristics are shown by color. The contact input is in the ON (operated) state if the input voltage is to the right of the colored threshold band (+/-10% tolerance), and the contact input is in the OFF (non-activated) state when input voltage is to the left of the band. A contact input is in LOW state during non-operated system condition, and actively switches to HIGH state upon detection of input voltage above the settable threshold.

Figure 3-29: Active impedance contact input V-I characteristic



### 3.3.7 Transducer inputs and outputs

Transducer input modules receive input signals from external DCmA output transducers (DCmA In) or resistance temperature detectors (RTDs). Hardware and software are provided to receive signals from these external transducers and convert these signals into a digital format for use as required.

Transducer output modules provide DC current outputs in several standard DCmA ranges. Software is provided to configure virtually any analog quantity used in the relay to drive the analog outputs.

Each transducer input/output module has 24 terminal connections. These connections are arranged as three terminals per row over eight rows. A given row can be used for either inputs or outputs, with terminals in column "a" having positive polarity and terminals in column "c" having negative polarity. Since an entire row is used for a single input/output channel, the name of the channel is assigned using the module slot position and row number.

Each module also requires that a connection from an external ground bus be made to terminal 8b. The current outputs require a twisted-pair shielded cable, where the shield is grounded at one end only. The following figure illustrates the transducer module types (5A, 5C, 5D, 5E, and 5F) and channel arrangements that can be ordered for the relay.



Where a tilde “~” symbol appears, substitute the slot position of the module.

Figure 3-30: Transducer input/output module wiring

~1a	+	dcmA In	~1	ANALOG I/O
~1c	-			
~2a	+	dcmA In	~2	
~2c	-			
~3a	+	dcmA In	~3	
~3c	-			
~4a	+	dcmA In	~4	
~4c	-			
~5a	+	dcmA Out	~5	
~5c	-			
~6a	+	dcmA Out	~6	
~6c	-			
~7a	+	dcmA Out	~7	
~7c	-			
~8a	+	dcmA Out	~8	
~8c	-			
~8b	⏏	SURGE		

~1a	Hot	RTD	~1	ANALOG I/O
~1c	Comp			
~1b	Return	for RTD ~1& ~2		
~2a	Hot	RTD	~2	
~2c	Comp			
~3a	Hot	RTD	~3	
~3c	Comp			
~3b	Return	for RTD ~3& ~4		
~4a	Hot	RTD	~4	
~4c	Comp			
~5a	Hot	RTD	~5	
~5c	Comp			
~5b	Return	for RTD ~5& ~6		
~6a	Hot	RTD	~6	
~6c	Comp			
~7a	Hot	RTD	~7	
~7c	Comp			
~7b	Return	for RTD ~7& ~8		
~8a	Hot	RTD	~8	
~8c	Comp			
~8b	⏏	SURGE		

~1a	Hot	RTD	~1	ANALOG I/O
~1c	Comp			
~1b	Return	for RTD ~1& ~2		
~2a	Hot	RTD	~2	
~2c	Comp			
~3a	Hot	RTD	~3	
~3c	Comp			
~3b	Return	for RTD ~3& ~4		
~4a	Hot	RTD	~4	
~4c	Comp			
~5a	+	dcmA Out	~5	
~5c	-			
~6a	+	dcmA Out	~6	
~6c	-			
~7a	+	dcmA Out	~7	
~7c	-			
~8a	+	dcmA Out	~8	
~8c	-			
~8b	⏏	SURGE		

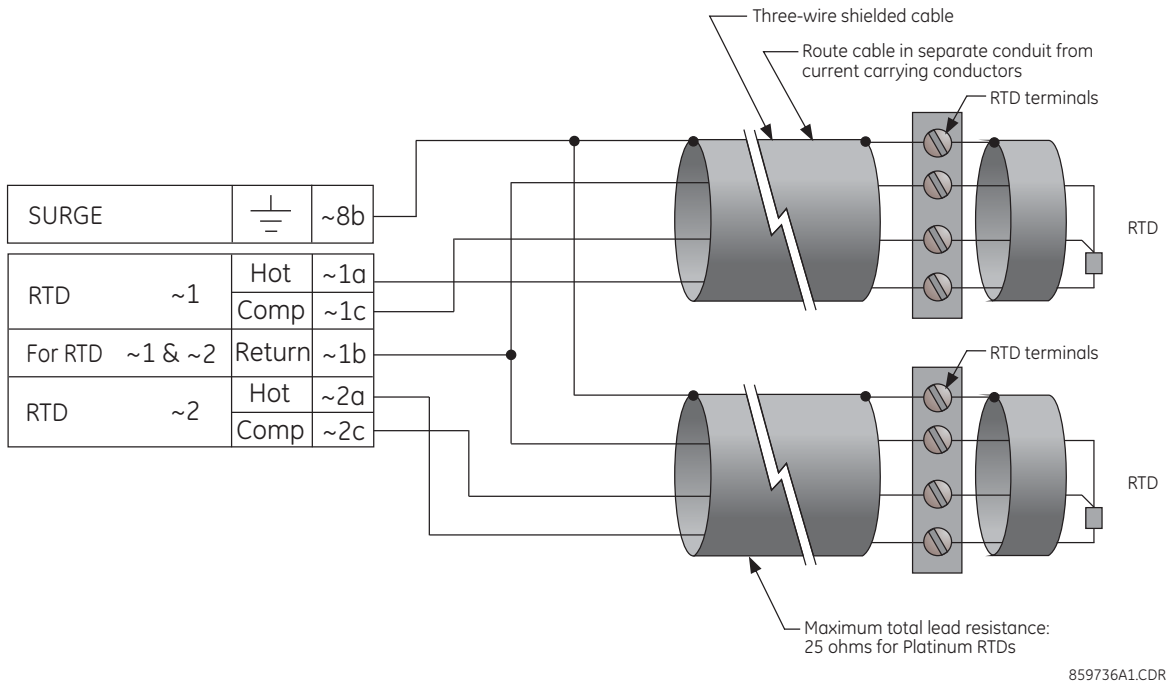
~1a	+	dcmA In	~1	ANALOG I/O
~1c	-			
~2a	+	dcmA In	~2	
~2c	-			
~3a	+	dcmA In	~3	
~3c	-			
~4a	+	dcmA In	~4	
~4c	-			
~5a	Hot	RTD	~5	
~5c	Comp			
~5b	Return	for RTD ~5& ~6		
~6a	Hot	RTD	~6	
~6c	Comp			
~7a	Hot	RTD	~7	
~7c	Comp			
~7b	Return	for RTD ~7& ~8		
~8a	Hot	RTD	~8	
~8c	Comp			
~8b	⏏	SURGE		

~1a	+	dcmA In	~1	ANALOG I/O
~1c	-			
~2a	+	dcmA In	~2	
~2c	-			
~3a	+	dcmA In	~3	
~3c	-			
~4a	+	dcmA In	~4	
~4c	-			
~5a	+	dcmA In	~5	
~5c	-			
~6a	+	dcmA In	~6	
~6c	-			
~7a	+	dcmA In	~7	
~7c	-			
~8a	+	dcmA In	~8	
~8c	-			
~8b	⏏	SURGE		

842764A1.CDR

The following figure show how to connect RTDs.

Figure 3-31: RTD connections

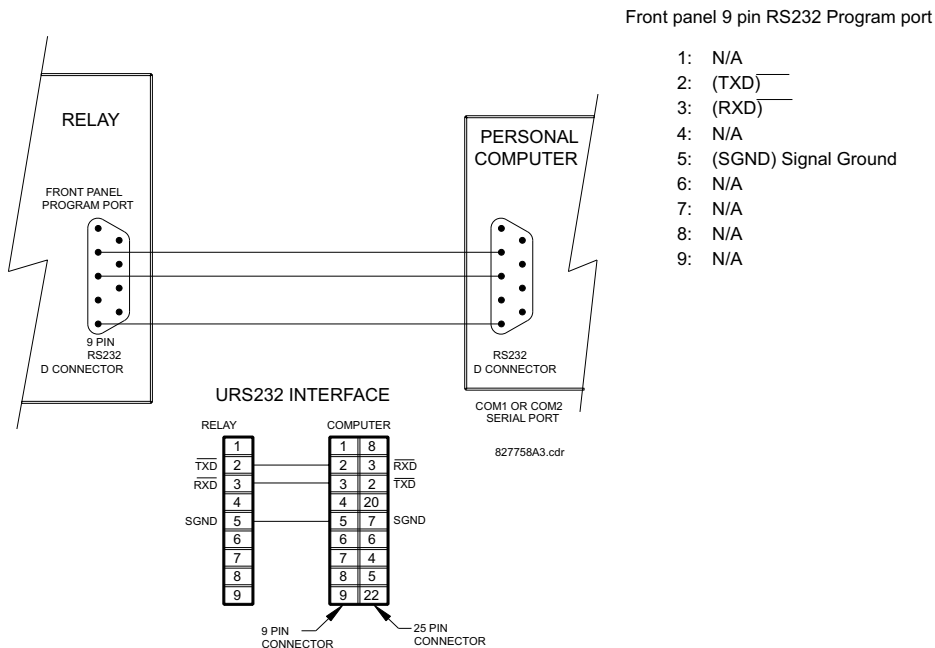


### 3.3.8 RS232 port

On the enhanced and basic front panels is a nine-pin RS232C serial port for programming with a computer. All that is required to use this interface is a computer running the EnerVista UR Setup software provided with the relay. Cabling for the RS232 port is shown in the following figure for the nine-pin connector on the UR and nine or 25-pin connector on a computer.

The baud rate for this port can be set, with a default of 115200 bps.

Figure 3-32: RS232 front panel port connection

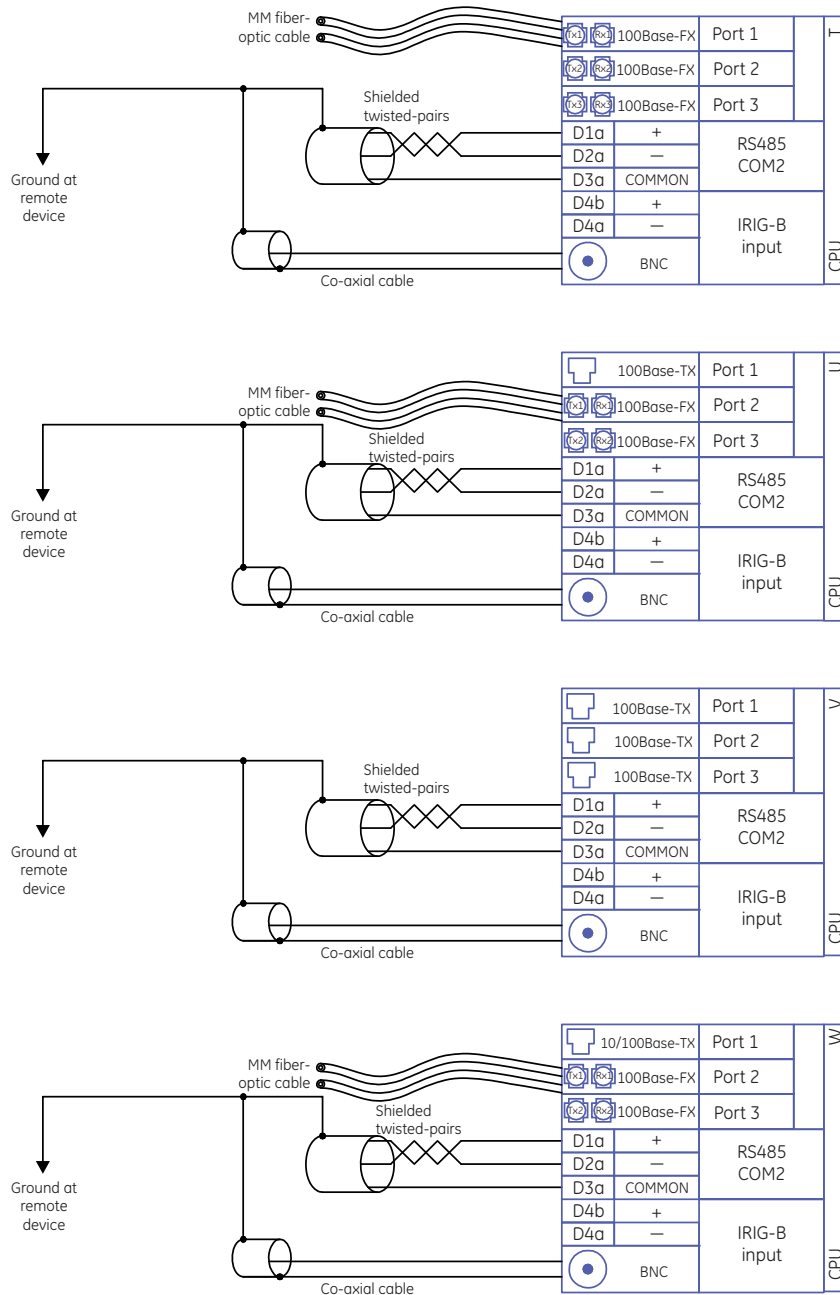


### 3.3.9 CPU communication ports

#### 3.3.9.1 Overview

There is a rear RS485 communication port on the CPU module. The CPU module does not require a surge ground connection.

Figure 3-33: CPU module communications wiring



859774A1.CDR

### 3.3.9.2 RS485 port

RS485 data transmission and reception are accomplished over a single twisted-pair wire with transmit and receive data alternating over the same two wires. Through the use of the port, continuous monitoring and control from a remote computer, SCADA system, or Power Line Carrier (PLC) is possible.

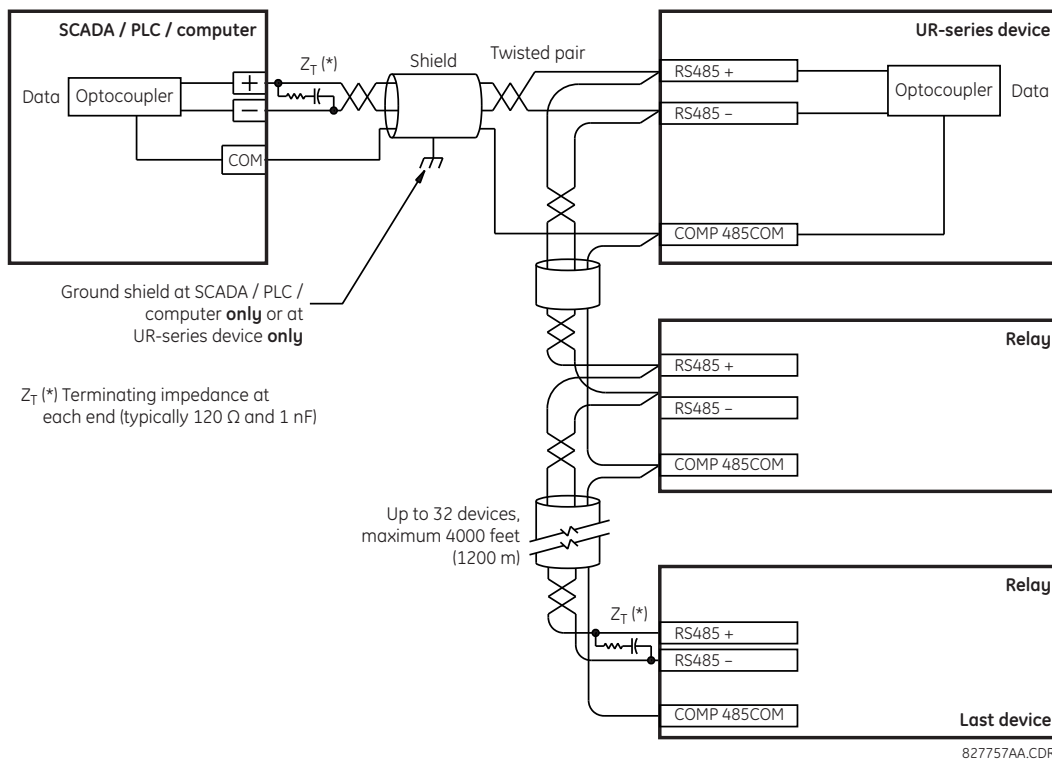
To minimize errors from noise, the use of shielded twisted-pair wire is recommended. Correct polarity must be observed. For instance, the relays must be connected with all RS485 “+” terminals connected together, and all RS485 “-” terminals connected together. Though data is transmitted over a two-wire twisted pair, all RS485 devices require a shared reference, or common voltage. This common voltage is implied to be a power supply common. Some systems allow the shield (drain wire) to be used as common wire and to connect directly to the G30 COM terminal (#3); others function correctly only if the common wire is connected to the G30 COM terminal, but insulated from the shield.

To avoid loop currents, ground the shield at only one point. If other system considerations require the shield to be grounded at more than one point, install resistors (typically 100 ohms) between the shield and ground at each grounding point. Each relay needs to be daisy-chained to the next one in the link. A maximum of 32 relays can be connected in this manner without exceeding driver capability. For larger systems, additional serial channels must be added. It is also possible to use commercially available repeaters to have more than 32 relays on a single channel. Avoid star or stub connections entirely.

Lightning strikes and ground surge currents can cause large momentary voltage differences between remote ends of the communication link. For this reason, surge protection devices are provided internally at both communication ports. An isolated power supply with an optocoupled data interface also acts to reduce noise coupling. To ensure maximum reliability, ensure that all equipment has similar transient protection devices installed.

Terminate both ends of the RS485 circuit with an impedance as shown in the figure.

Figure 3-34: RS485 serial connection



### 3.3.9.3 100Base-FX fiber optic ports

The fiber-optic communication ports allow for fast and efficient communications between relays at 100 Mbps. Optical fiber can be connected to the relay supporting a wavelength of 1310 nm in multimode.

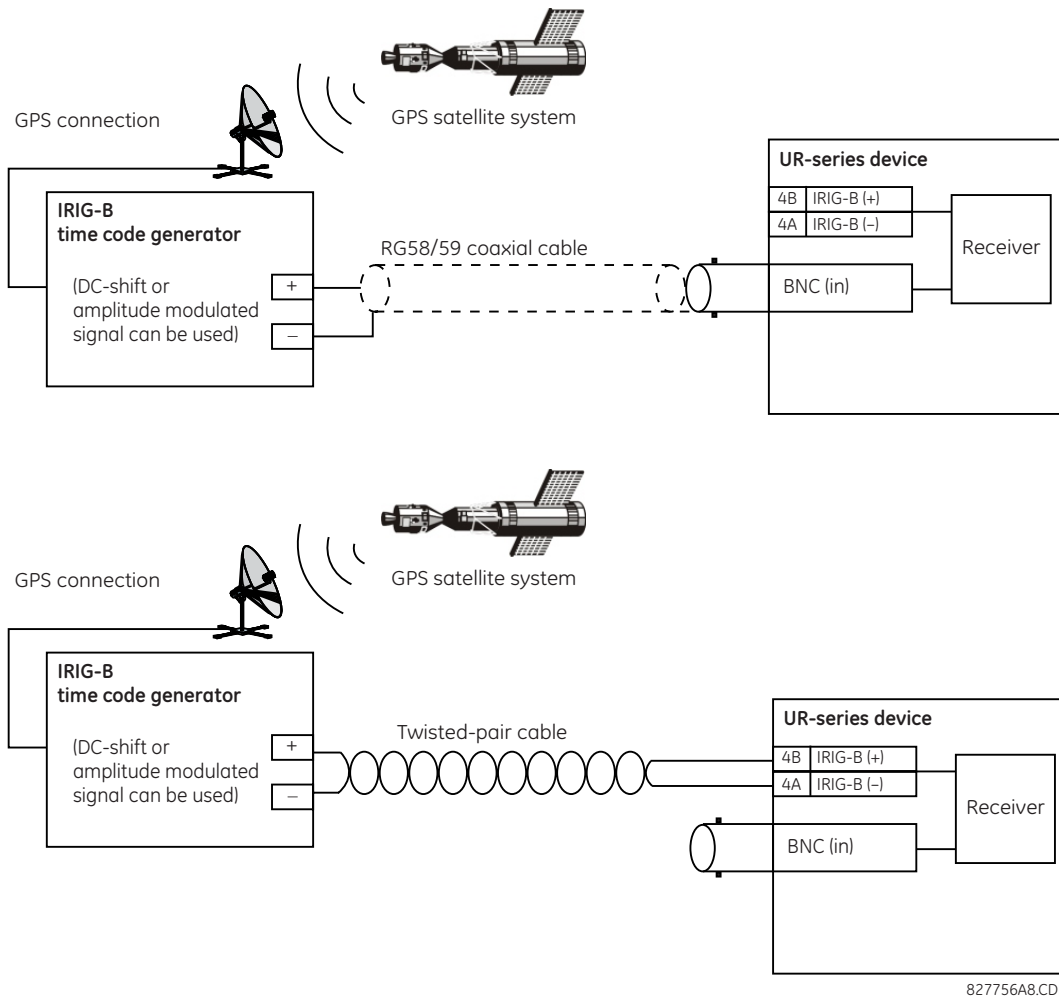
Ensure that the dust covers are installed when the fiber is not in use. Dirty or scratched connectors can lead to high losses on a fiber link.

### 3.3.10 IRIG-B

There is a round IRIG-B connector at the back of the CPU module, marked "IN". Use is optional.

IRIG-B is a standard time code format that allows stamping of events to be synchronized among connected devices. The IRIG-B code allows time accuracies of up to 100 ns. The GE MultiSync 100 1588 GPS Clock as well as third-party equipment are available for generating the IRIG-B signal. This equipment can use a global positioning system (GPS) satellite system to obtain the time reference so that devices at different geographic locations can be synchronized. The IRIG time code formats are serial, pulse width-modulated codes that can be either DC level shifted or amplitude modulated (AM). Using IRIG-B input, the G30 operates an internal oscillator with 1  $\mu$ s resolution and accuracy.

Figure 3-35: Options for IRIG-B connection



Using an amplitude-modulated receiver causes errors up to 1 ms in event time stamping.

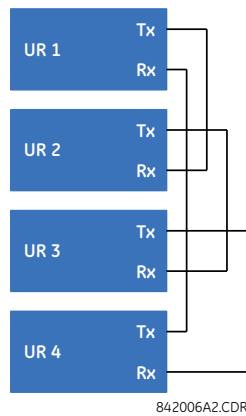
### 3.4 Direct input and output communications

#### 3.4.1 Description

The direct inputs and outputs feature makes use of the type 7 series of communications modules and allows direct messaging between UR devices. The communications modules are outlined in the table later in this section.

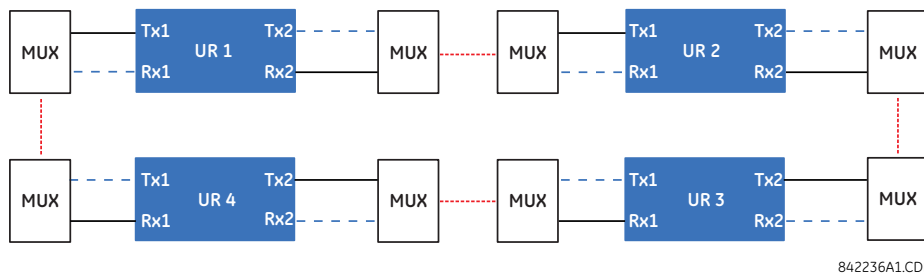
The communications channels are normally connected in a ring configuration, as shown in the following figure. The transmitter of one module is connected to the receiver of the next module. The transmitter of this second module is then connected to the receiver of the next module in the ring. This is continued to form a communications ring. The figure illustrates a ring of four UR-series relays with the following connections: UR1-Tx to UR2-Rx, UR2-Tx to UR3-Rx, UR3-Tx to UR4-Rx, and UR4-Tx to UR1-Rx. A maximum of 16 URs can be connected in a single ring.

Figure 3-36: Direct input and output single-channel connection



Inter-relay communication (IRC) modules with protocol C37.94 and G.703 are designed for back-to-back communication connections, so the ring configuration shown in the previous figure does not apply. To establish inter-relay communication in more than two URs, you need to have a two-channel IRC module and enable the **DIRECT I/O CHANNEL CROSSOVER** setting in all relays, as shown in the next figure. This configuration can be expanded to 16 URs, and this configuration does not provide a redundancy ring since both channels are made into a single ring by the channel crossover function. As per the figure entitled Typical Pin Interconnection between Two G.703 Interfaces later in this chapter, the clock is supplied typically by multiplexer (MUX) and all URs are in Loop Timing Mode. If there is no MUX, then UR1 and UR3 can be in Internal Timing Mode and UR2 and UR4 can be in Loop Timing Mode. That is, connected channels must have opposite timing modes.

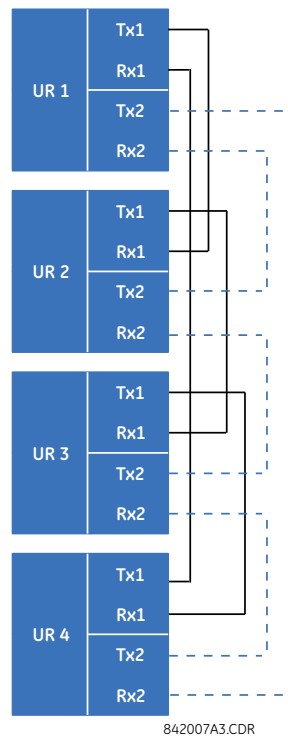
Figure 3-37: Ring configuration for C37.94 module (concept also applies to G.703)



The interconnection for dual-channel type 7 communications modules is shown as follows. Two-channel modules allow for a redundant ring configuration. That is, two rings can be created to provide an additional independent data path. The required connections are: UR1-Tx1 to UR2-Rx1, UR2-Tx1 to UR3-Rx1, UR3-Tx1 to UR4-Rx1, and UR4-Tx1 to UR1-Rx1 for the first ring; and UR1-Tx2 to UR4-Rx2, UR4-Tx2 to UR3-Rx2, UR3-Tx2 to UR2-Rx2, and UR2-Tx2 to UR1-Rx2 for the second ring.

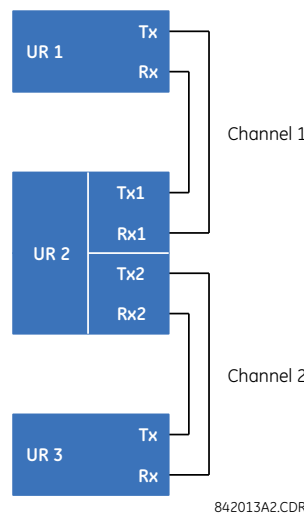


Figure 3-38: Direct input and output dual-channel connection



The following figure shows the connection for three UR-series relays using two independent communication channels. UR1 and UR3 have single type 7 communication modules; UR2 has a dual-channel module. The two communication channels can be of different types, depending on the type 7 modules used. To allow the direct input and output data to cross-over from channel 1 to channel 2 on UR2, set the **DIRECT I/O CHANNEL CROSSOVER** setting to “Enabled” on UR2. This forces UR2 to forward messages received on Rx1 out Tx2, and messages received on Rx2 out Tx1.

Figure 3-39: Direct input and output single/dual channel combination connection

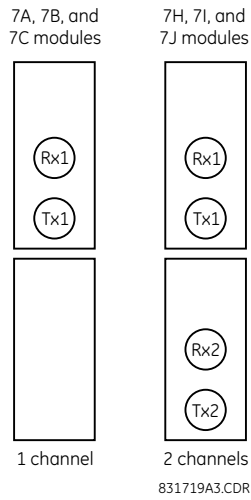


The inter-relay communications modules are available with several interfaces and some are outlined here in more detail. Those that apply depend on options purchased. The options are outlined in the Inter-Relay Communications section of the Order Code tables in Chapter 2. All of the fiber modules use ST type connectors.

### 3.4.2 Fiber: LED and ELED transmitters

The following figure shows the configuration for the 7A, 7B, 7C, 7H, 7I, and 7J fiber-only modules.

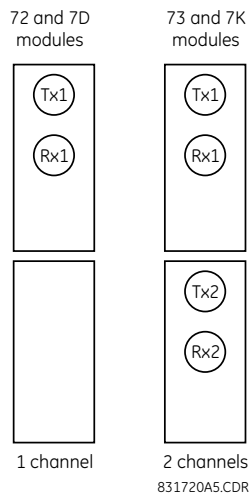
Figure 3-40: LED and ELED fiber modules



### 3.4.3 Fiber laser transmitters

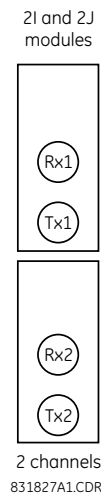
The following figure shows the configuration for the 72, 73, 7D, and 7K fiber-laser modules.

Figure 3-41: 7x Laser fiber modules



The following figure shows configuration for the 2I and 2J fiber-laser modules.

Figure 3-42: 2I and 2J laser fiber modules



**CAUTION**

Observing any fiber transmitter output can injure the eye.

**NOTICE**

When using a laser Interface, attenuators can be necessary to ensure that you do not exceed the maximum optical input power to the receiver.

### 3.4.4 G.703 interface

#### 3.4.4.1 Description

G.703 is an International Telecommunications Union (ITU) standard for the transmission of data and voice signals. Modules 7R (one channel) and 7S (two channels) apply.

The following figure shows the 64K ITU G.703 co-directional interface configuration. This is module 7S.

The G.703 module is fixed at 64 kbps. The **SETTINGS** ⇒ **PRODUCT SETUP** ⇒ **DIRECT I/O** ⇒ **DIRECT I/O DATA RATE** setting is not applicable to this module.

AWG 24 twisted shielded pair wiring is recommended for external connections, with the shield grounded only at one end. Connecting the shield to pin X1a or X6a grounds the shield since these pins are connected internally to ground. Thus, if pin X1a or X6a is used to ground the shield at one end, do not ground the shield at the other end. This interface module is protected by surge suppression devices.

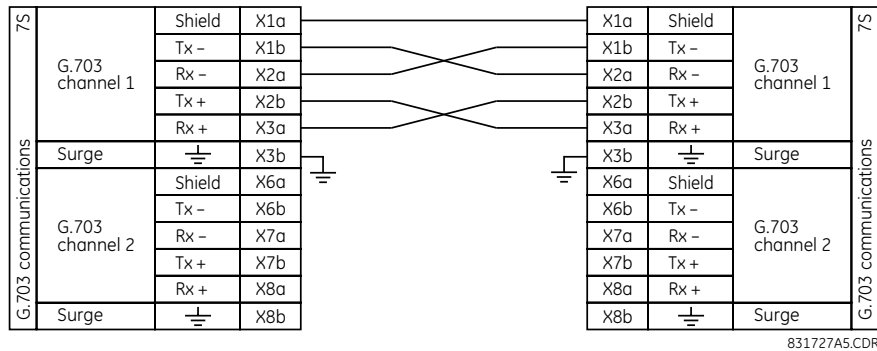
Figure 3-43: G.703 interface configuration


7S G.703 communications	G.703 channel 1	Shield	~1a
		Tx -	~1b
		Rx -	~2a
		Tx +	~2b
		Rx +	~3a
	Surge		~3b
	G.703 channel 2	Shield	~6a
		Tx -	~6b
		Rx -	~7a
		Tx +	~7b
Rx +		~8a	
Surge		~8b	

842773A3.CDR

The following figure shows the typical pin interconnection between two G.703 interfaces. For the actual physical arrangement of these pins, see the Rear Terminal Layout section earlier in this chapter. All pin interconnections are to be maintained for a connection to a multiplexer.

**Figure 3-44: Typical pin interconnection between two G.703 interfaces**



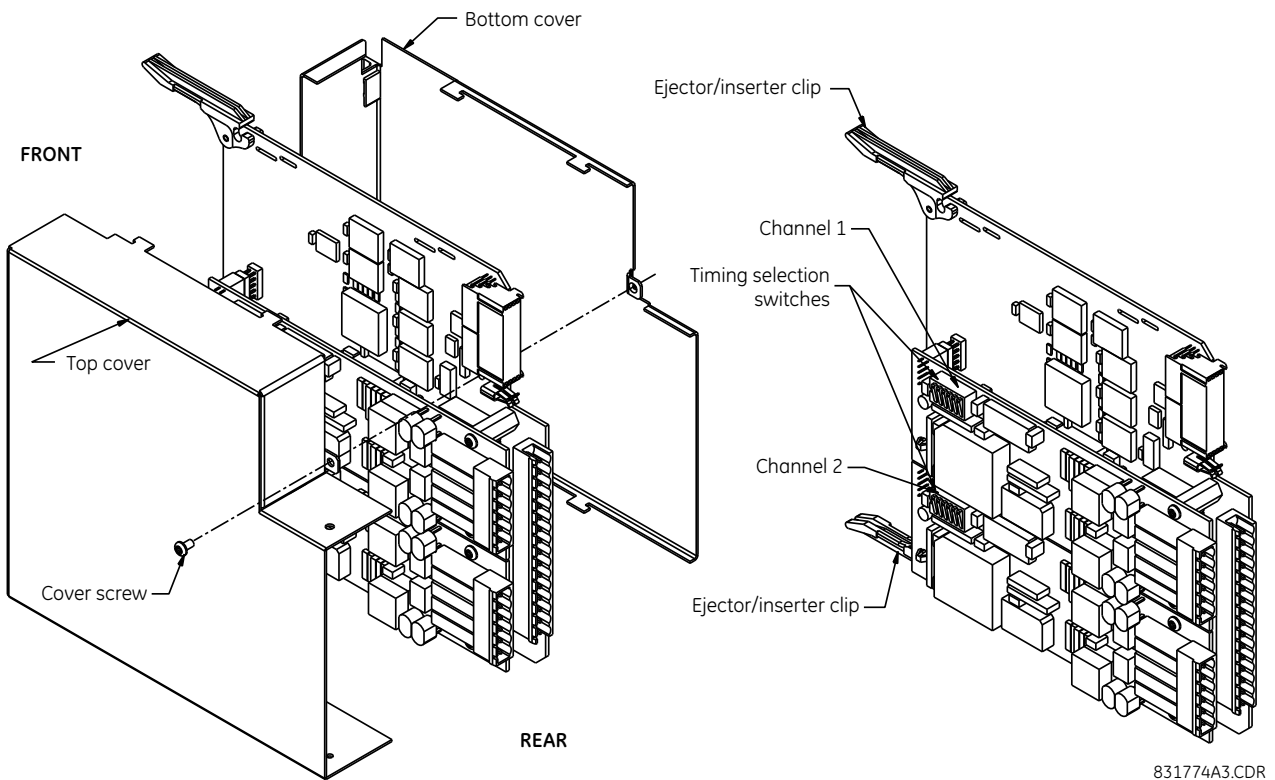
 Pin nomenclature differs from one manufacturer to another. It is not uncommon to see pinouts numbered TxA, TxB, RxA, and RxB. In such cases, assume that "A" is equivalent to "+" and "B" is equivalent to "-."

**NOTE**

### 3.4.4.2 G.703 selection switch procedures

1. With the power to the relay off, remove the G.703 module (7R or 7S) as follows. Record the original location of the module to help ensure that the same or replacement module is inserted into the correct slot.
2. Simultaneously pull the ejector/insert clips located at the top and at the bottom of each module in order to release the module for removal. (For more information on accessing modules, see the Maintenance chapter.)
3. Remove the module cover screw.
4. Remove the top cover by sliding it towards the rear and then lift it upwards.
5. Set the timing selection switches (channels 1 and 2) to the required timing modes.
6. Replace the top cover and the cover screw.
7. Re-insert the G.703 module. Take care to ensure that the correct module type is inserted into the correct slot position. The ejector/insert clips located at the top and bottom of each module must be in the disengaged position as the module is inserted smoothly into the slot. Once the clips have cleared the raised edge of the chassis, engage the clips simultaneously. When the clips have locked into position, the module is inserted fully.

Figure 3-45: G.703 timing selection switch setting



831774A3.CDR

Table 3-6: G.703 timing selections

Switches	Function
S1	OFF → octet timing disabled ON → octet timing 8 kHz
S5 and S6	S5 = OFF and S6 = OFF → loop timing mode S5 = ON and S6 = OFF → internal timing mode S5 = OFF and S6 = ON → minimum remote loopback mode S5 = ON and S6 = ON → dual loopback mode

### 3.4.4.3 G.703 octet timing

If octet timing is enabled (ON), this 8 kHz signal is asserted during the violation of bit 8 (LSB) necessary for connecting to higher order systems. When G30s are connected back-to-back, octet timing is disabled (OFF).

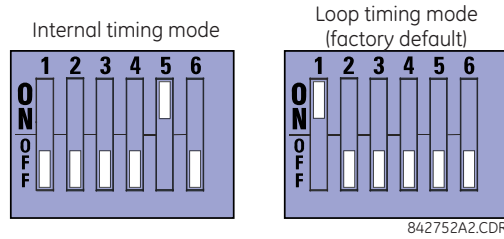
### 3.4.4.4 G.703 timing modes

There are two timing modes for the G.703 module: internal timing mode and loop timing mode (default).

- **Internal Timing Mode** — The system clock is generated internally. Therefore, set the G.703 timing selection to internal timing mode for back-to-back (UR-to-UR) connections. For back-to-back connections, set octet timing (S1 = OFF) and timing mode to internal timing (S5 = ON and S6 = OFF).
- **Loop Timing Mode** — The system clock is derived from the received line signal. Therefore, set the G.703 timing selection to loop timing mode for connections to higher order systems. For connection to a higher order system (UR-to-multiplexer, factory defaults), set to octet timing (S1 = ON) and set timing mode to loop timing (S5 = OFF and S6 = OFF).

The switch settings for the internal and loop timing modes are shown.

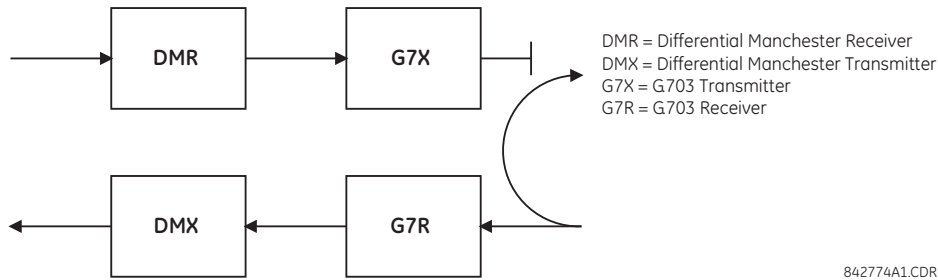
Figure 3-46: Switches



3.4.4.5 G.703 test modes

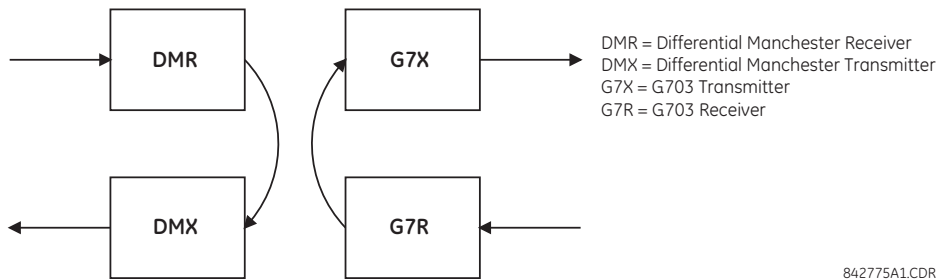
In *minimum remote loopback mode*, the multiplexer is enabled to return the data from the external interface without any processing to assist in diagnosing G.703 line-side problems irrespective of clock rate. Data enters from the G.703 inputs, passes through the data stabilization latch that also restores the proper signal polarity, passes through the multiplexer, and then returns to the transmitter. The differential received data is processed and passed to the G.703 transmitter module after which point the data is discarded. The G.703 receiver module is fully functional and continues to process data and passes it to the differential Manchester transmitter module. Since timing is returned as it is received, the timing source is expected to be from the G.703 line side of the interface.

Figure 3-47: G.703 minimum remote loopback mode



In *dual loopback mode*, the multiplexers are active and the functions of the circuit are divided into two with each receiver/transmitter pair linked together to deconstruct and then reconstruct their respective signals. Differential Manchester data enters the Differential Manchester receiver module and then is returned to the differential Manchester transmitter module. Likewise, G.703 data enters the G.703 receiver module and is passed through to the G.703 transmitter module to be returned as G.703 data. Because of the complete split in the communications path and because, in each case, the clocks are extracted and reconstructed with the outgoing data, in this mode there must be two independent sources of timing. One source lies on the G.703 line side of the interface while the other lies on the differential Manchester side of the interface.

Figure 3-48: G.703 dual loopback mode



### 3.4.5 RS422 interface

#### 3.4.5.1 Description

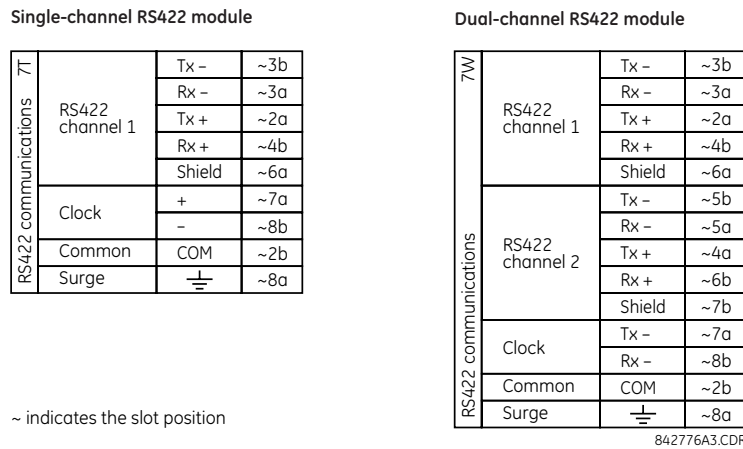
There are two RS422 inter-relay communications modules available: single-channel (module 7T) and dual-channel (module 7W). The modules can be configured to run at 64 kbps or 128 kbps. AWG 20 to 24 twisted shielded pair cable is recommended for external connections. These modules are protected by optically-isolated surge suppression devices. The shield pins (6a and 7b) are connected internally to the ground pin (8a). Proper shield termination is as follows:

The shield pins (6a and 7b) are connected internally to the ground pin (8a). Proper shield termination is as follows:

- Site 1 — Terminate shield to pins 6a or 7b or both
- Site 2 — Terminate shield to COM pin 2b

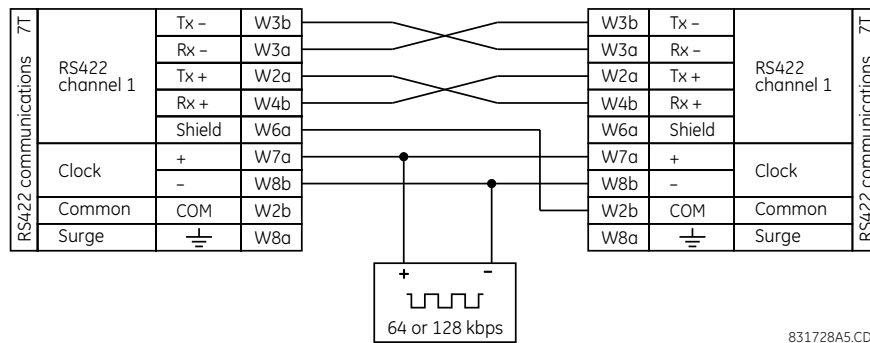
Match the clock terminating impedance with the impedance of the line.

Figure 3-49: RS422 interface connections



The following figure shows the typical pin interconnection between two single-channel RS422 interfaces installed in slot W. All pin interconnections are to be maintained for a connection to a multiplexer.

Figure 3-50: Typical pin interconnect between two RS422 interfaces

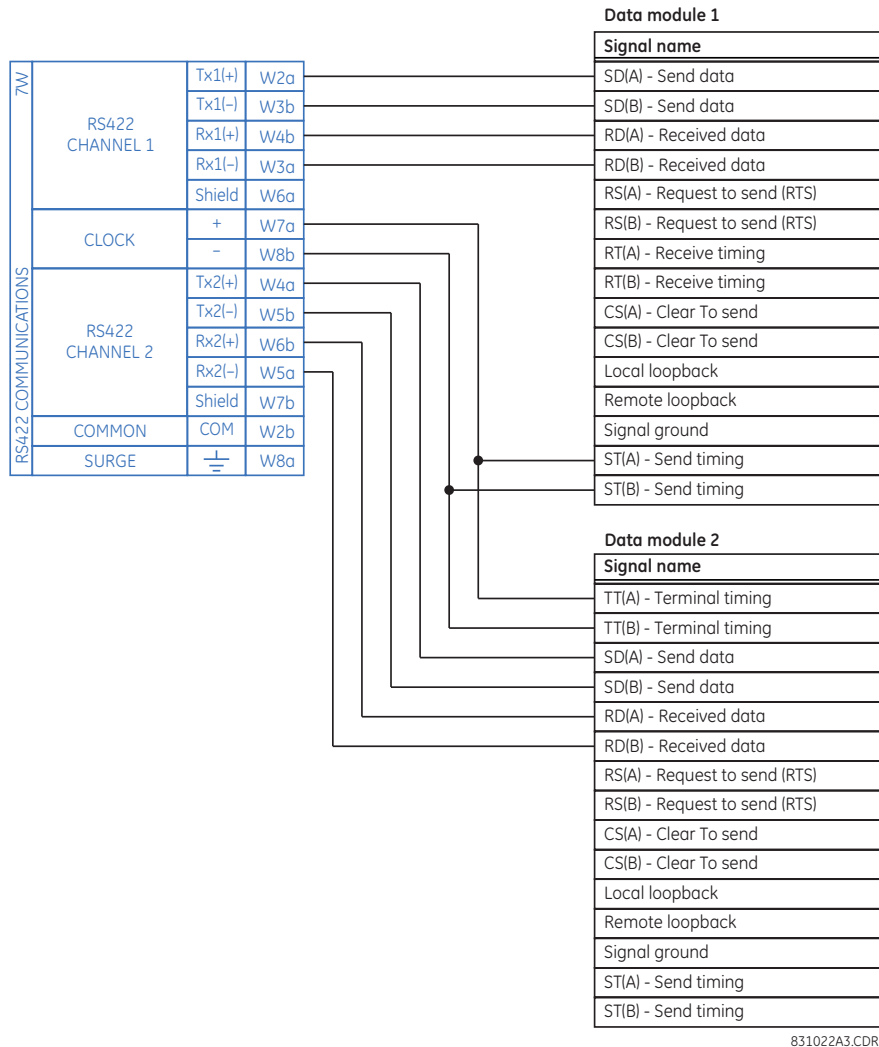


#### 3.4.5.2 Two-channel application via multiplexers

The RS422 interface can be used for single-channel or two-channel applications over SONET/SDH or multiplexed systems. When used in single-channel applications, the RS422 interface links to higher-order systems in a typical way, observing transmit (Tx), receive (Rx), and send timing (ST) connections. However, when used in two-channel applications, certain criteria must be followed since there is one clock input for the two RS422 channels. The system functions correctly when the following connections are observed and your data module has a terminal timing feature. Terminal timing is a common feature in most synchronous data units that allows the module to accept timing from an external source. Using the terminal timing feature, two-channel applications can be achieved if these connections are followed: the send timing

outputs from the multiplexer (data module 1) connects to the clock inputs of the UR RS422 interface in the usual way. In addition, the send timing outputs of data module 1 are also paralleled to the terminal timing inputs of data module 2. By using this configuration, the timing for both data modules and both UR RS422 channels is derived from a single clock source. As a result, data sampling for both of the UR RS422 channels is synchronized via the send timing leads on data module 1, shown as follows. If the terminal timing feature is not available or this type of connection is not wanted, the G.703 interface is a viable option that does not impose timing restrictions.

**Figure 3-51: Timing configuration for RS422 two-channel, three-terminal application**



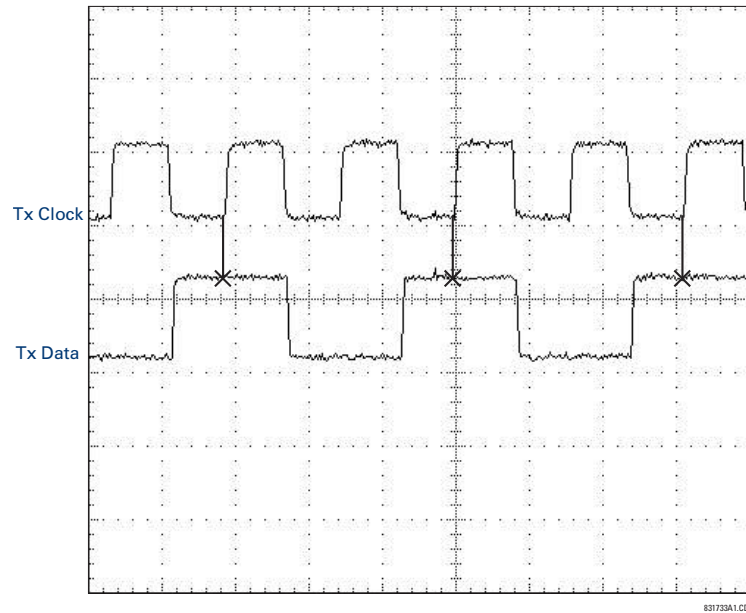
Data module 1 provides timing to the G30 RS422 interface via the ST(A) and ST(B) outputs. Data module 1 also provides timing to data module 2 TT(A) and TT(B) inputs via the ST(A) and AT(B) outputs. The data module pin numbers have been omitted in the figure because they vary by manufacturer.

### 3.4.5.3 Transmit timing

The RS422 interface accepts one clock input for transmit timing. It is important that the rising edge of the 64 kHz transmit timing clock of the multiplexer interface is sampling the data in the center of the transmit data window. Therefore, it is important to confirm clock and data transitions to ensure proper system operation. For example, the following figure shows the positive edge of the Tx clock in the center of the Tx data bit.



Figure 3-52: Clock and data transitions



### 3.4.5.4 Receive timing

The RS422 interface utilizes NRZI-MARK modulation code and therefore does not rely on an Rx clock to recapture data. NRZI-MARK is an edge-type, invertible, self-clocking code.

To recover the Rx clock from the data-stream, an integrated digital phase lock loop (DPLL) circuit is utilized. The DPLL is driven by an internal clock, which is 16-times over-sampled, and uses this clock along with the data-stream to generate a data clock that can be used as the serial communication controller (SCC) receive clock.

### 3.4.6 RS422 and fiber interface

The following figure shows the combined RS422 plus fiberoptic interface configuration at 64 K baud. The 7L, 7M, 7N, 7P, and 74 modules are used in two-terminal with a redundant channel or three-terminal configurations where channel 1 is employed via the RS422 interface (possibly with a multiplexer) and channel 2 via direct fiber.

AWG 20 to 24 twisted shielded pair wiring is recommended for external RS422 connections. Ground the shield only at one end. For the direct fiber channel, address power budget issues properly.

**NOTICE** When using a laser interface, attenuators can be necessary to ensure that you do not exceed maximum optical input power to the receiver.

Figure 3-53: RS422 and fiber interface connection

7L, 7M, 7N, 7P, and 74	Clock channel 1	+	~1a	
		-	~1b	
	Common	COM	~2b	
		RS422 channel 1	Tx -	~3b
			Rx -	~3a
			Tx +	~2a
Rx +			~4b	
Shield	~6a			
RS422 communications	Fiber channel 2	(Tx2) (Rx2)		
	Surge	⏏	~8a	

842777A3.CDR

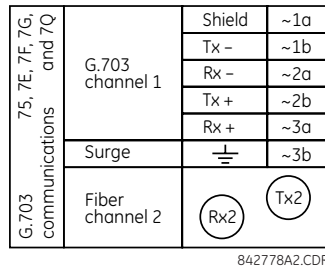
The connections shown in the figure are for multiplexers configured as data communications equipment (DCE) units.

### 3.4.7 G.703 and fiber interface

The following figure shows the combined G.703 plus fiber-optic interface configuration at 64 kbps. The 7E, 7F, 7G, 7Q, and 75 modules are used in configurations where channel 1 is employed via the G.703 interface (possibly with a multiplexer) and channel 2 via direct fiber. AWG 24 twisted shielded pair wiring is recommended for external G.703 connections connecting the shield to pin 1a at one end only. For the direct fiber channel, address power budget issues properly. See previous sections for details on the G.703 and fiber interfaces.

**NOTICE** When using a laser interface, attenuators can be necessary to ensure that you do not exceed the maximum optical input power to the receiver.

Figure 3-54: G.703 and fiber interface connection



### 3.4.8 IEEE C37.94 interface

IEEE C37.94 is a standard interface between teleprotection equipment and digital multiplexers.

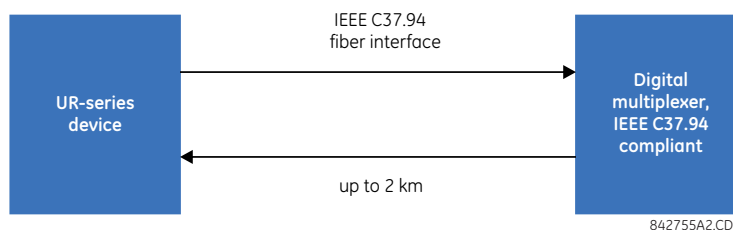
The UR-series IEEE C37.94 modules (module types 2I, 2J, 76, and 77) are designed to interface with IEEE C37.94 compliant digital multiplexers or an IEEE C37.94 compliant interface converter for use with direct input and output applications. The IEEE C37.94 standard defines a point-to-point optical link for synchronous data between a multiplexer and a teleprotection device. Data speed is typically 64 kbps, but the standard provides for speeds up to 64n kbps, where n = 1, 2, ..., 12. The UR-series C37.94 communication modules are either 64 kbps (with n fixed at 1) or 128 kbps (with n fixed at 2). The frame is a valid International Telecommunications Union (ITU-T) recommended G.704 pattern from the standpoint of framing and data rate. The frame is 256 bits and is repeated at a frame rate of 8000 Hz, with a resultant bit rate of 2048 kbps.

The specifications for the module are as follows:

- IEEE standard — C37.94 for 2 × 64 kbps optical fiber interface (for 76 and 77 modules)
- Fiber-optic cable type — 50 nm or 62.5 μm core diameter optical fiber
- Fiber-optic mode — multimode
- Fiber-optic cable length — up to 2 km
- Fiber-optic connector — type ST
- Wavelength — 820 ±40 nm
- Connection — as per all fiber-optic connections, a Tx-to-Rx connection is required

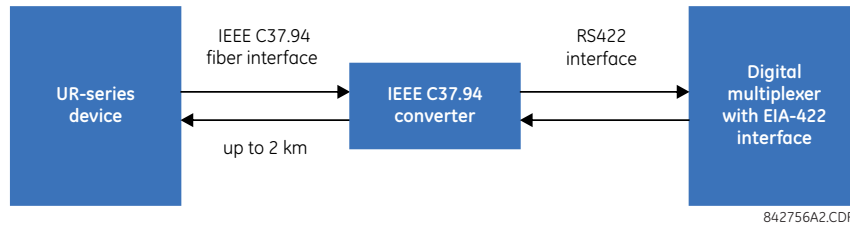
The UR-series C37.94 module can be connected directly to any compliant digital multiplexer that supports the IEEE C37.94 standard. The figure shows the concept.

Figure 3-55: IEEE C37.94 connection to compliant digital multiplexer



The UR-series C37.94 communication module can be connected to the electrical interface (G.703, RS422, or X.21) of a non-compliant digital multiplexer via an optical-to-electrical interface converter that supports the IEEE C37.94 standard. The following figure shows the concept.

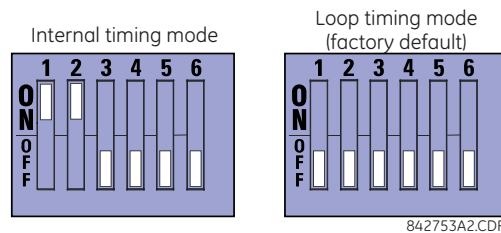
**Figure 3-56: IEEE C37.94 connection to non-compliant digital multiplexer**



In 2008, GE Grid Solutions released revised modules 76 and 77 for C37.94 communication to enable multi-ended fault location functionality with firmware 5.60 release and higher. All modules 76 and 77 shipped since the change support this feature and are fully backward compatible with firmware releases below 5.60. For customers using firmware release 5.60 and higher, the module can be identified with "Rev D" printed on it and is to be used on all ends of G30 communication for two and three terminal applications. Failure to use it at all ends results in intermittent communication alarms. For customers using firmware revisions below 5.60, it is not required to match the revision of the modules installed.

The UR-series C37.94 communication module has six switches to set the clock configuration. The following figure shows the functions of these control switches.

**Figure 3-57: Switches**



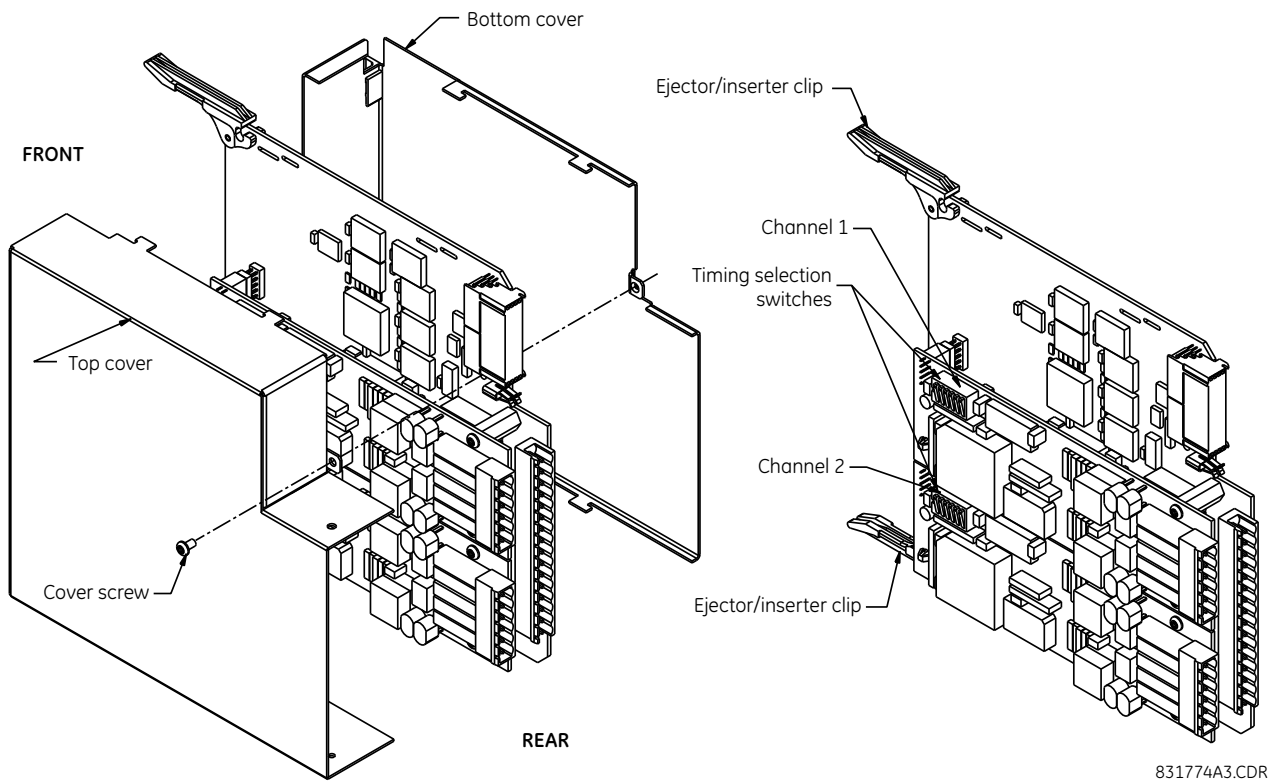
For the internal timing mode, the system clock is generated internally. Therefore, set the timing switch selection to internal timing for relay 1 and loop timed for relay 2. There must be only one timing source configured.

For the looped timing mode, the system clock is derived from the received line signal. Therefore, set the timing selection to loop timing mode for connections to higher order systems.

The IEEE C37.94 communications module cover removal procedure is as follows:

1. With power to the relay off, remove the IEEE C37.94 module (type 2I, 2J, 76, or 77 module) as follows. Record the original location of the module to help ensure that the same or replacement module is inserted into the correct slot.
2. Simultaneously pull the ejector/inserter clips located at the top and bottom of each module in order to release the module for removal.
3. Remove the module cover screw.
4. Remove the top cover by sliding it towards the rear and then lift it upwards.
5. Set the timing selection switches (channels 1 and 2) to the required timing modes (see description earlier).
6. Replace the top cover and the cover screw.
7. Re-insert the IEEE C37.94 module. Take care to ensure that the correct module type is inserted into the correct slot position. The ejector/inserter clips located at the top and at the bottom of each module must be in the disengaged position as the module is inserted smoothly into the slot. Once the clips have cleared the raised edge of the chassis, engage the clips simultaneously. When the clips have locked into position, the module is inserted fully.

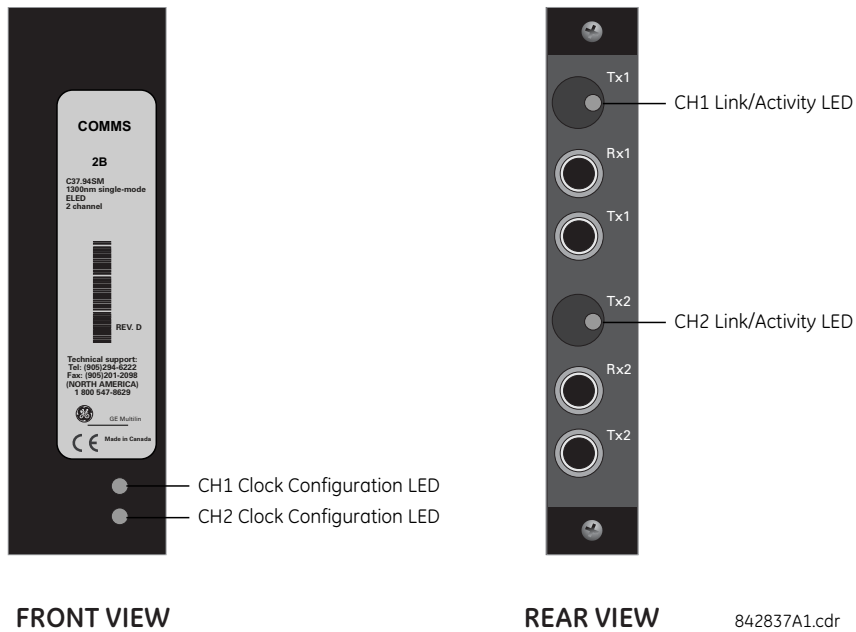
Figure 3-58: IEEE C37.94 timing selection switch setting



831774A3.CDR

Modules shipped since January 2012 have status LEDs that indicate the status of the DIP switches, as shown in the following figure.

Figure 3-59: Status LEDs



842837A1.cdr

The clock configuration LED status is as follows:

- Flashing green — loop timing mode while receiving a valid data packet
- Flashing yellow — internal mode while receiving a valid data packet
- Solid red — (switch to) internal timing mode while not receiving a valid data packet

The link/activity LED status is as follows:

- Flashing green — FPGA is receiving a valid data packet
- Solid yellow — FPGA is receiving a "yellow bit" and remains yellow for each "yellow bit"
- Solid red — FPGA is not receiving a valid packet or the packet received is invalid

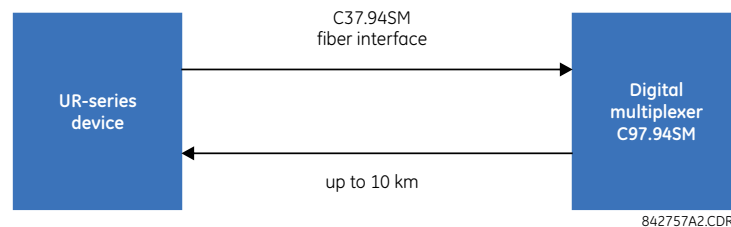
### 3.4.9 C37.94SM interface

The UR-series C37.94SM communication modules (2A and 2B) are designed to interface with modified IEEE C37.94 compliant digital multiplexers or IEEE C37.94 compliant interface converters that have been converted from 820 nm multi-mode fiber optics to 1300 nm ELED single-mode fiber optics. The IEEE C37.94 standard defines a point-to-point optical link for synchronous data between a multiplexer and a teleprotection device. This data is typically 64 kbps, but the standard provides for speeds up to  $64n$  kbps, where  $n = 1, 2, \dots, 12$ . The UR-series C37.94SM communication module is 64 kbps only with  $n$  fixed at 1. The frame is a valid ITU-recommended G.704 pattern from the standpoint of framing and data rate. The frame is 256 bits and is repeated at a frame rate of 8000 Hz, with a resultant bit rate of 2048 kbps.

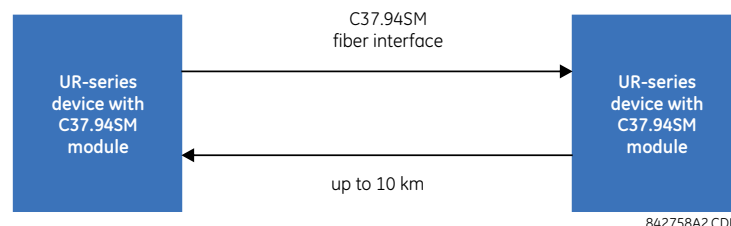
The specifications for the module are as follows:

- Emulated IEEE standard — Emulates C37.94 for  $1 \times 64$  kbps optical fiber interface (modules set to  $n = 1$  or 64 kbps)
- Fiber-optic cable type — 9/125  $\mu\text{m}$  core diameter optical fiber
- Fiber-optic mode — Single-mode, ELED compatible with HP HFBR-1315T transmitter and HP HFBR-2316T receiver
- Fiber-optic cable length — Up to 11.4 km
- Fiber-optic connector — Type ST
- Wavelength — 1300  $\pm 40$  nm
- Connection — As per all fiber-optic connections, a Tx-to-Rx connection is required

The UR-series C37.94SM communication module can be connected directly to any compliant digital multiplexer that supports C37.94SM, as shown.



It also can be connected directly to any other UR-series relay with a C37.94SM module, as shown.

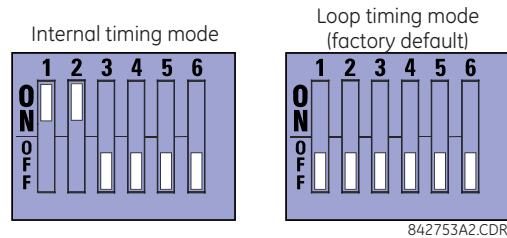


In 2008, GE Grid Solutions released revised modules 2A and 2B for C37.94SM communication to enable multi-ended fault location functionality with firmware 5.60 release and higher. All modules 2A and 2B shipped since the change support this feature and are fully backward compatible with firmware releases below 5.60. For customers using firmware release 5.60

and higher, the module can be identified with "Rev D" printed on it and is to be used on all ends of G30 communication for two and three terminal applications. Failure to use it at all ends results in intermittent communication alarms. For customers using firmware revisions below 5.60, it is not required to match the revision of the modules installed.

The UR-series C37.94SM module has six switches that are used to set the clock configuration. The following figure shows the functions of these control switches.

Figure 3-60: Switches



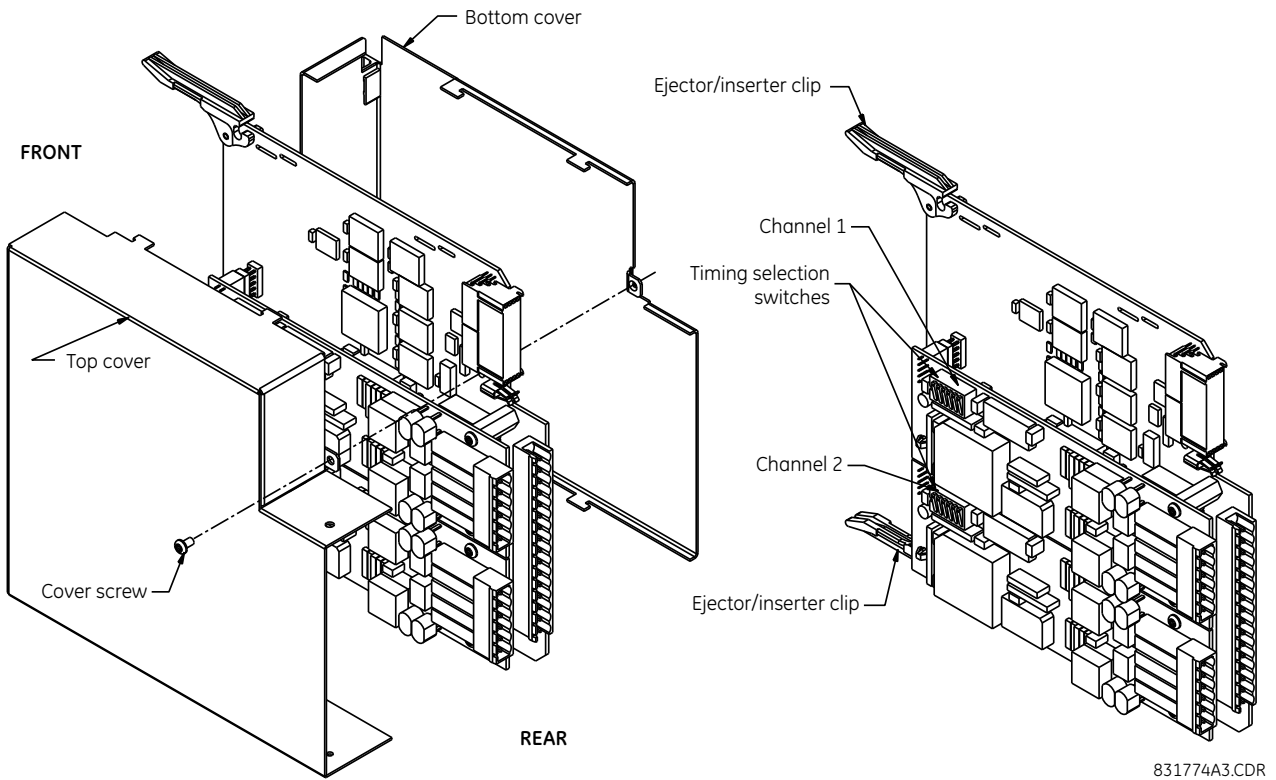
For the internal timing mode, the system clock is generated internally. Therefore, set the timing switch selection to internal timing for relay 1 and loop timed for relay 2. There must be only one timing source configured.

For the looped timing mode, the system clock is derived from the received line signal. Therefore, set the timing selection to loop timing mode for connections to higher-order systems.

The C37.94SM communications module cover removal procedure is as follows:

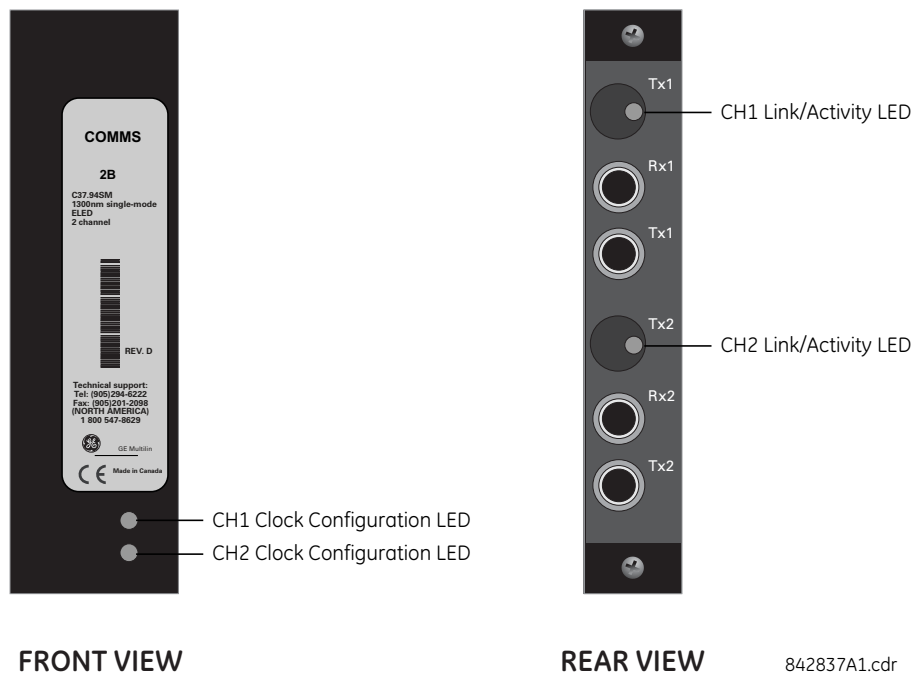
1. With power to the relay off, remove the C37.94SM module (module 2A or 2B) as follows. Record the original location of the module to help ensure that the same or replacement module is inserted into the correct slot.
2. Simultaneously pull the ejector/inserters clips located at the top and at the bottom of each module in order to release the module for removal.
3. Remove the module cover screw.
4. Remove the top cover by sliding it towards the rear and then lift it upwards.
5. Set the timing selection switches (channels 1 and 2) to the required timing modes (see description earlier).
6. Replace the top cover and the cover screw.
7. Re-insert the C37.94SM module. Take care to ensure that the correct module type is inserted into the correct slot position. The ejector/inserters clips located at the top and at the bottom of each module must be in the disengaged position as the module is inserted smoothly into the slot. Once the clips have cleared the raised edge of the chassis, engage the clips simultaneously. When the clips have locked into position, the module is inserted fully.

Figure 3-61: C37.94SM timing selection switch setting



Modules shipped since January 2012 have status LEDs that indicate the status of the DIP switches, as shown in the following figure.

Figure 3-62: Status LEDs



The clock configuration LED status is as follows:

- Flashing green — loop timing mode while receiving a valid data packet
- Flashing yellow — internal mode while receiving a valid data packet
- Solid red — (switch to) internal timing mode while not receiving a valid data packet

The link/activity LED status is as follows:

- Flashing green — FPGA is receiving a valid data packet
- Solid yellow — FPGA is receiving a "yellow bit" and remains yellow for each "yellow bit"
- Solid red — FPGA is not receiving a valid packet or the packet received is invalid

### 3.5 Activate relay

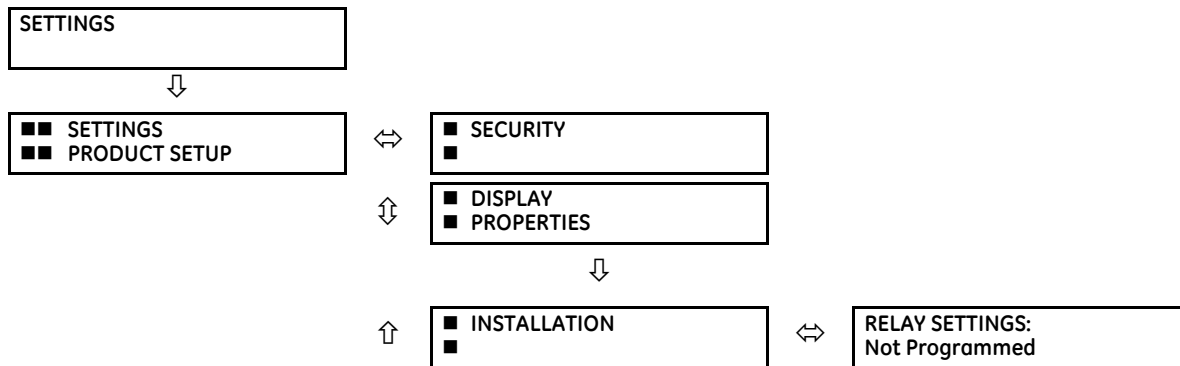
The relay is in the default "Not Programmed" state when it leaves the factory. When powered up successfully, looking at the front panel, the "Trouble" LED is on and the "In Service" LED is off. The relay in the "Not Programmed" state blocks signaling of any output relay. These conditions remain until the relay is explicitly put into "Programmed" state.

<b>RELAY SETTINGS: Not Programmed</b>	When the relay is powered up, the "Trouble LED" is on, the "In Service" LED is off, and this message displays, indicating that the relay is in the "Not Programmed" state and is safeguarding (output relays blocked) against the installation of a relay whose settings have not been entered. This message remains until the relay is explicitly put into "Programmed" state.
---	---

The relay can be activated on the front panel or in the EnerVista software.

To activate the relay using the front panel:

1. Press the **MENU** key until the **SETTINGS** header flashes momentarily and the **PRODUCT SETUP** message displays.
2. Press the **MESSAGE** right arrow until the **SECURITY** message displays.
3. Press the **MESSAGE** down arrow until the **INSTALLATION** message displays.
4. Press the **MESSAGE** right arrow until the **RELAY SETTINGS: Not Programmed** message displays.



5. After the **RELAY SETTINGS: Not Programmed** message displays, press a **VALUE** key to change the selection to "Programmed."
6. Press the **ENTER** key to save the change.



7. When the "NEW SETTING HAS BEEN STORED" message appears, the relay is in "Programmed" state and the "In Service" LED turns on.



To activate the relay using EnerVista software:

1. Navigate to **Settings > Product Setup > Installation** and change the **Relay Settings** field to "Programmed."
2. Save the change.

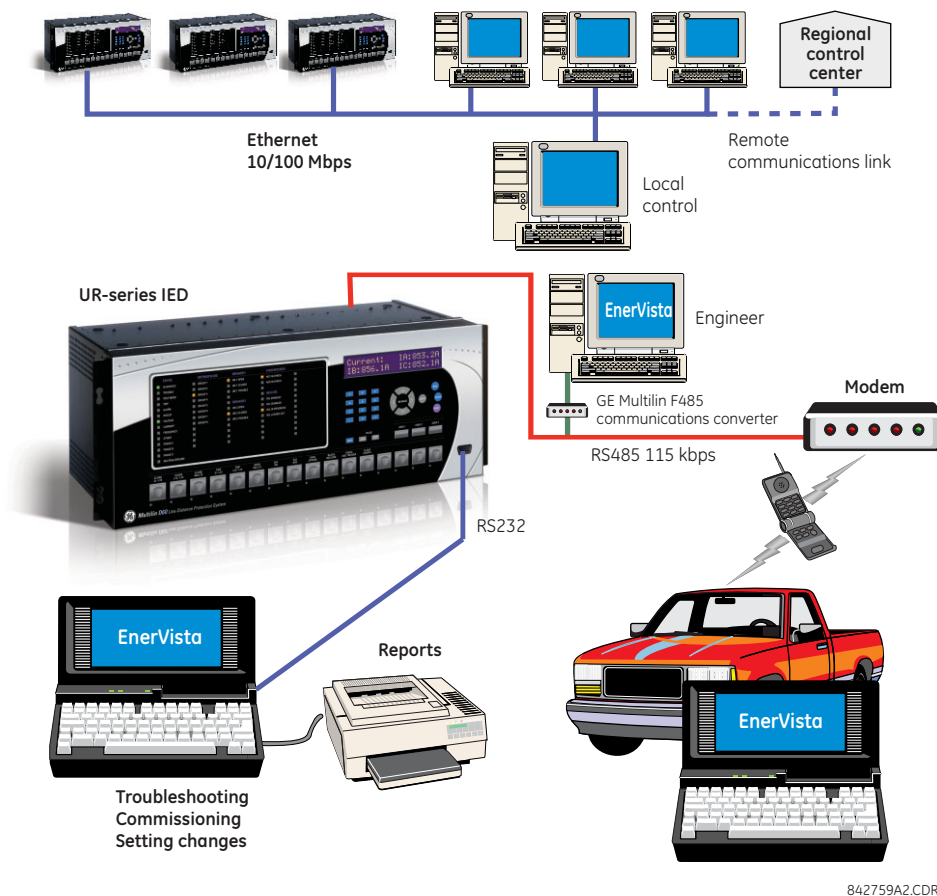
## 3.6 Install software

### 3.6.1 EnerVista communication overview

The EnerVista UR Setup software communicates to the relay via the front panel RS232 or USB port or the rear RS485 / Ethernet ports.

To communicate via the RS232 port, use a standard straight-through serial cable. Connect the DB-9 male end to the relay and the DB-9 or DB-25 female end to the computer COM2 port as described in the CPU Communication Ports section earlier in this chapter.

Figure 3-63: Relay communication options



842759A2.CDR

To communicate through the G30 rear RS485 port from a computer RS232 port, the GE Grid Solutions RS232/RS485 converter box is required. This device (catalog number F485) connects to the computer using a straight-through serial cable. A shielded twisted-pair wire (20, 22, or 24 AWG) connects the F485 converter to the G30 rear communications port. The converter terminals (+, -, GND) are connected to the G30 communication module (+, -, COM) terminals. See the CPU Communication Ports section in chapter 3 for details. The line is terminated with an R-C network (that is, 120  $\Omega$ , 1 nF) as described in this chapter.

## 3.6.2 System requirements

The relay front panel or the EnerVista UR Setup software can be used to communicate with the relay. The software interface is the preferred method to edit settings and view actual values because the computer monitor can display more information.

The system requirements for the EnerVista software are as follows:

- Intel Pentium processor (dual core) or (recommended) Core Duo
- Microsoft Windows 7 with Service Pack 1 (32-bit or 64-bit), Windows 10, Windows Server 2008 Release 2 with Service Pack 1 (64-bit), or Windows Server 2012 Release 2 (64-bit), in the required EnerVista language, such as French or Japanese
- 1 GB free hard drive space
- 2 GB RAM
- 1280 x 800 display screen

## 3.6.3 Install software

After ensuring that the requirements for using EnerVista UR Setup software are met, there are three ways to install the software:

- From the DVD
- Download EnerVista Launchpad software from <http://www.gegridsolutions.com/multilin> and install it
- Download the EnerVista UR Setup software from <http://www.gegridsolutions.com/multilin> and install it

Install on a computer that has an operating system in the required language, for example a German operating system for use with EnerVista software in German.



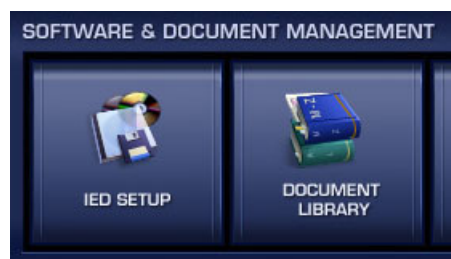
The front panel can be switched in the EnerVista software between enhanced and basic panels under **Maintenance > Change Front Panel**.

NOTE

To install the software from the DVD and using EnerVista Launchpad:

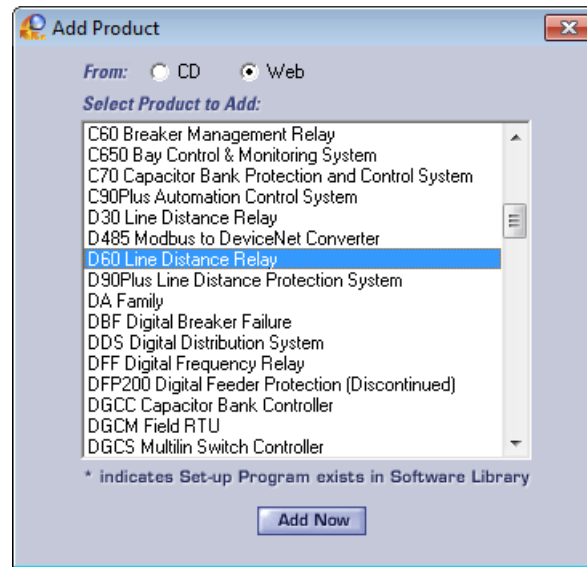
1. Insert the DVD into the DVD drive of your computer.
2. Click the **Install Now** button and follow the instructions.
3. When installation is complete, start the EnerVista Launchpad application.
4. Click the **IED Setup** section of the **Launch Pad** window.

Figure 3-64: Adding a UR device in Launchpad window



5. In the EnerVista Launch Pad window, click the **Add Product** button and select the appropriate product as follows. Select the **Web** option to ensure the most recent software release, or select **CD** if you do not have an Internet connection, then click the **Add Now** button to list software items for the product. EnerVista Launchpad obtains the software from the Internet or DVD and automatically starts the installation program after prompting about updates. From the web, the software is downloaded. A wizard opens.

Figure 3-65: Identifying the UR device type



- In the wizard, click the **Next** button and complete the process. The files are installed in the directory indicated, and the installation program automatically creates icons and adds an entry to the Windows start menu. The UR device is added to the EnerVista Launchpad window, as shown.

Figure 3-66: UR device added to Launchpad window



- For other than English, configure the language for the front panel in the EnerVista software under **Settings > Product Setup > Display Properties**. User-entered strings are not translated, for example relay names, so setting the language now ensures that the names are entered/displayed in the required language. For the EnerVista software language, access the **View > Language** menu item.

## 3.7 Add device to software

You connect remotely to the G30 through the rear RS485 or Ethernet port with a computer running the EnerVista UR Setup software. The G30 also can be accessed locally with a computer through the front panel RS232 or USB port or the rear Ethernet port using the Quick Connect feature.

The following procedures are outlined:

- Add device for serial access; see the Configure Serial Connection section
- Add device for the rear Ethernet port; see the Configure Ethernet Connection section
- Add device for access using a modem; see the Configure Modem Connection section

- Connect locally with a computer through either the front RS232 or USB port or rear Ethernet port; see the Connect to the G30 section
- Discover automatically UR devices within a network; see the Automatic Discovery of UR Devices section

Devices in the Device Setup window are listed in the order entered.

Devices in the main software window are listed alphabetically. Use the **Device Name** to order them as required, for example B30 Odessa, B30 Truro, B90, T35.

You cannot import a file to add a device to the software. You can import settings as outlined at the end of the chapter.

The Quick Connect button also can be used to add devices. The device is added to a Quick Connect menu item in the Online Window area, cannot be moved from it to another grouping, and needs to be renamed in the Device Setup window. GE instead recommends using the Device Setup window to add devices, as outlined here.

3

### 3.7.1 Set IP address in UR

Implement IP addresses for the computer and a G30 device as follows.

The UR family supports the use of subnetworks as documented in RFC 950, which divides class-based networks into subnetworks (non-CIDR). The classes and IP address ranges are defined as follows.

**Table 3-7: IP address classes**

Classes	IP address range	Default subnet mask address	UR devices
A	1.0.0.0 to 127.255.255.255	255.0.0.0	65,535 or more
B	128.0.0.0 to 191.255.255.255	255.255.0.0	255 to 65,534
C	192.0.0.0 to 223.255.255.255	255.255.255.0	0 to 254
D	224.0.0.0 to 239.255.255.255	(Reserved for multicasting)	
E	240.0.0.0 to 255.255.255.255	(Reserved)	

Both network and subnet addresses are contained within a range. The number of hosts determines the class and addresses as follows:

- Class A 255.0.0.0 — The first octet (255) specifies the network, the second to fourth octets (0) specify the subnet and host. Use this class when you have more than 65,535 hosts (UR devices).
- Class B 255.255.0.0 — The first two octets (255) specify the network, the third octet (0) specifies the subnet, and the fourth octet (0) specifies the host. Use this class when you have 255 to 65,534 hosts (UR devices).
- Class C 255.255.255.0 — The first three octets (255) specify the network and the last octet (0) specifies the subnet and host. Use this class when you have up to 254 hosts (UR devices).

An example of implementation is one computer and one UR device. Because there is one UR device, class C addressing is required. So we use UR 192.167.2.x with subnet mask 255.255.255.0 and computer 192.167.3.x with subnet mask 255.255.255.0.

For older, non-CIDR routing protocols, such as RIP version 1, follow these restrictions:

- Identical subnet masks — Use a single mask for all subnets within a network
- Contiguous subnets — The subnets must be contiguous and not split among networks. The subnets cannot pass traffic through other networks.

The IP and subnet addresses need to be added to the UR for Ethernet communication.

For serial communication, for example using any front RS232 port and the Quick Connect feature, the addresses are not required, but typically they are entered to add/configure devices for regular use.

To add the IP addresses:

1. On the front of the UR, press the **MENU** key until the **SETTINGS** menu displays.
2. Navigate to **SETTINGS** ⇒ **PRODUCT SETUP** ⇩ ⇒ **COMMUNICATIONS** ⇩ ⇒ **NETWORK** ⇒ **PRT IP ADDRESS SETTING**.
3. Enter an IP address, for example 10.11.33.1, and press the **ENTER** key to save the value. For example, press the period key to clear any existing address, then press the number keys to add anew address.

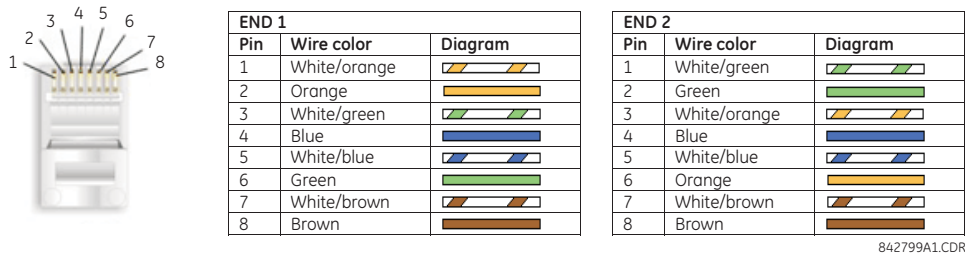
4. In the same menu, select the **PRT SUBNET IP MASK** setting. Enter a subnet IP address, for example 255.0.0.0.
5. Press the **ENTER** key to save the value.

The gateway address also needs to be configured when connecting through an Ethernet network. Access **SETTINGS** ⇒ **PRODUCT SETUP** ⇩ ⇒ **COMMUNICATIONS** ⇩ ⇒ **IPv4 ROUTE TABLE** ⇩ ⇒ **DEFAULT IPv4 ROUTE** ⇒ **GATEWAY ADDRESS**.

If using a blue or grey Ethernet cable, skip the rest of the this section. If using an orange cross-over Ethernet cable, the computer needs to be set up as follows.

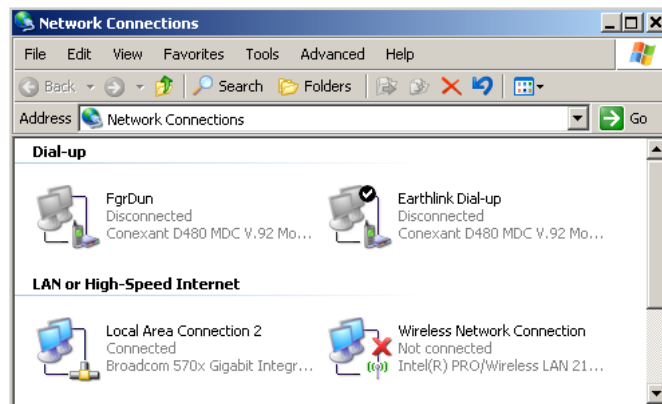
1. Use an orange Ethernet cross-over cable to connect the computer to the rear Ethernet port. In case you need it, the following figure shows the pinout for an Ethernet cross-over cable.

**Figure 3-67: Ethernet cross-over cable PIN layout**

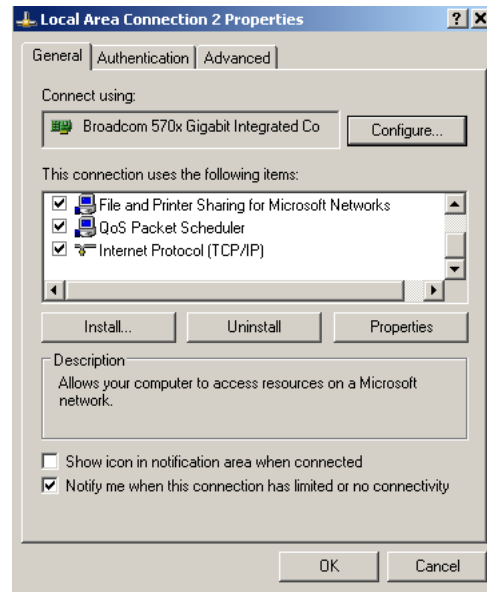


Next, assign the computer an IP address compatible with the relay's IP address.

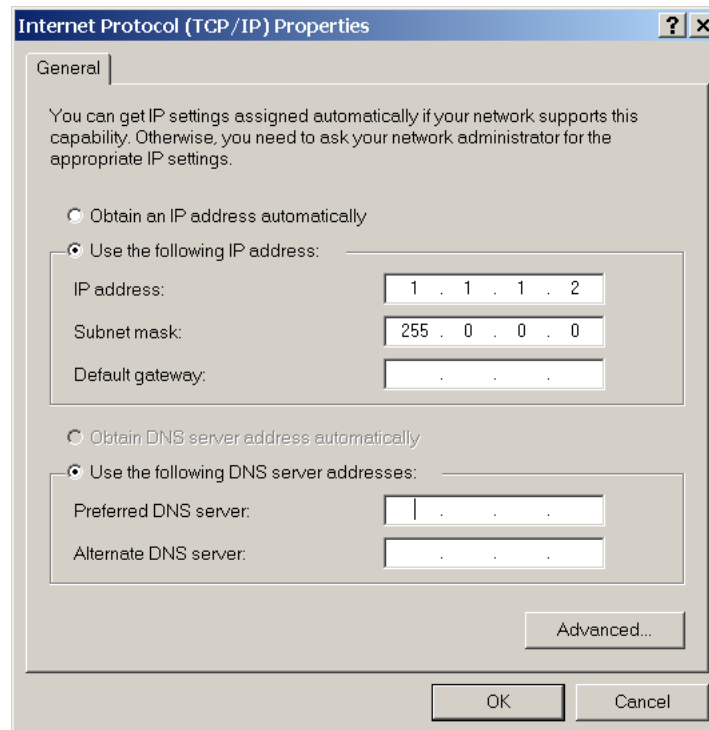
1. From the Windows desktop, right-click the **My Network Places** icon and select **Properties** to open the network connections window. Or in Windows 7, access the **Network and Sharing Center** in the Control Panel.



- Right-click the **Local Area Connection** icon and select **Properties**.



- Select the **Internet Protocol (TCP/IP)** item from the list, and click the **Properties** button.



- Click the "Use the following IP address" box.
- Enter an **IP address** with the first three numbers the same as the IP address of the G30 relay and the last number different (in this example, 1.1.1.2).
- Enter a subnet mask equal to the one set in the G30 (in this example, 255.0.0.0).
- Click the **OK** button to save the values.

Before continuing, test the Ethernet connection.

1. Open a Windows console window, for example by selecting **Start > Run** from the Windows **Start** menu and typing "cmd" or clicking the **Start** button and entering "cmd".
2. Type the following command, substituting the IP address of 1.1.1.1 with yours:

```
C:\WINNT>ping 1.1.1.1
```

3. If the connection is successful, the system returns four replies similar to the following:

```
Pinging 1.1.1.1 with 32 bytes of data:
Reply from 1.1.1.1: bytes=32 time<10ms TTL=255
Reply from 1.1.1.1: bytes=32 time<10ms TTL=255
Reply from 1.1.1.1: bytes=32 time<10ms TTL=255
Reply from 1.1.1.1: bytes=32 time<10ms TTL=255
Ping statistics for 1.1.1.1:
    Packets: Sent = 4, Received = 4, Lost = 0 (0% loss),
    Approximate round trip time in milliseconds:
        Minimum = 0ms, Maximum = 0ms, Average = 0 ms
```

4. Note that the values for **time** and **TTL** vary depending on local network configuration.
5. If the following sequence of messages appears when entering the C:\WINNT>ping 1.1.1.1 command:

```
Pinging 1.1.1.1 with 32 bytes of data:
Request timed out.
Request timed out.
Request timed out.
Request timed out.
Ping statistics for 1.1.1.1:
    Packets: Sent = 4, Received = 0, Lost = 4 (100% loss),
    Approximate round trip time in milliseconds:
        Minimum = 0ms, Maximum = 0ms, Average = 0 ms
Pinging 1.1.1.1 with 32 bytes of data:
```

verify the physical connection between the G30 and the computer, and double-check the programmed IP address in the **PRODUCT SETUP** ⇒ **COMMUNICATIONS** ⇒ **NETWORK** ⇒ **IP ADDRESS** setting, then repeat step 2.

6. If the following sequence of messages appears when entering the C:\WINNT>ping 1.1.1.1 command:

```
Pinging 1.1.1.1 with 32 bytes of data:
Hardware error.
Hardware error.
Hardware error.
Hardware error.
Ping statistics for 1.1.1.1:
    Packets: Sent = 4, Received = 0, Lost = 4 (100% loss),
    Approximate round trip time in milliseconds:
        Minimum = 0ms, Maximum = 0ms, Average = 0 ms
Pinging 1.1.1.1 with 32 bytes of data:
```

verify the physical connection between the G30 and the computer, and double-check the programmed IP address in the **PRODUCT SETUP** ⇒ **COMMUNICATIONS** ⇒ **NETWORK** ⇒ **IP ADDRESS** setting, then repeat step 2.

7. If the following sequence of messages appears when entering the C:\WINNT>ping 1.1.1.1 command:

```
Pinging 1.1.1.1 with 32 bytes of data:
Destination host unreachable.
Destination host unreachable.
Destination host unreachable.
Destination host unreachable.
Ping statistics for 1.1.1.1:
    Packets: Sent = 4, Received = 0, Lost = 4 (100% loss),
    Approximate round trip time in milliseconds:
        Minimum = 0ms, Maximum = 0ms, Average = 0 ms
Pinging 1.1.1.1 with 32 bytes of data:
```

verify the IP address is programmed in the local computer by entering the ipconfig command in the command window.

```
C:\WINNT>ipconfig
Windows IP Configuration
```

```

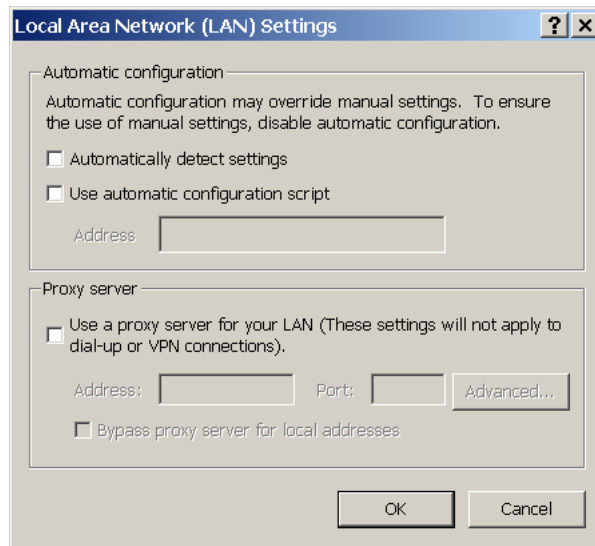
Ethernet adapter <F4FE223E-5EB6-4BFB-9E34-1BD7BE7F59FF>:
    Connection-specific DNS suffix. . . :
    IP Address. . . . . : 0.0.0.0
    Subnet Mask . . . . . : 0.0.0.0
    Default Gateway . . . . . :
Ethernet adapter Local Area Connection:
    Connection-specific DNS suffix . . :
    IP Address. . . . . : 1.1.1.2
    Subnet Mask . . . . . : 255.0.0.0
    Default Gateway . . . . . :
C:\WINNT>

```

Before using the Quick Connect feature through the Ethernet port, disable any configured proxy settings in Internet Explorer.

3

1. Start the Internet Explorer software.
2. Select the **Tools > Internet Options** menu item and click the **Connections** tab.
3. Click on the **LAN Settings** button to open the following window.



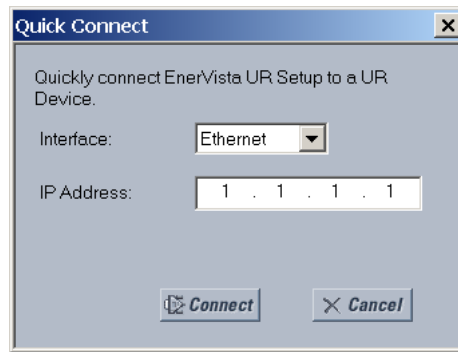
4. Ensure that the “Use a proxy server for your LAN” box is not checked.

If this computer is used to connect to the Internet, re-enable any proxy server settings after the computer has been disconnected from the G30 relay.

1. Start the Internet Explorer software.
2. Select the UR device from the EnerVista Launchpad to start EnerVista UR Setup.



- Click the **Quick Connect** button to open the window.

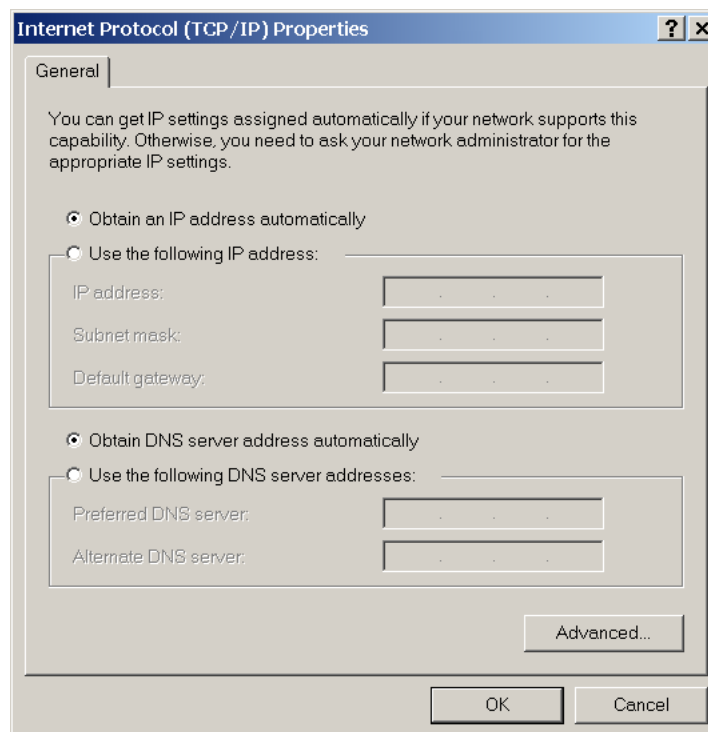


- Select the **Ethernet** interface and enter the IP address assigned to the G30, then click the **Connect** button. The EnerVista UR Setup software creates a site named “Quick Connect” with a corresponding device also named “Quick Connect” and displays them on the left side of the screen.
- Expand the sections to view data directly from the G30 device.

Each time that the EnerVista UR Setup software is initialized, click the **Quick Connect** button to establish direct communications to the G30. This ensures that configuration of the EnerVista UR Setup software matches the G30 model number.

When direct communications with the G30 via Ethernet is complete, make the following changes:

- From the Windows desktop, right-click the **My Network Places** icon and select **Properties** to open the network connections window.
- Right-click the **Local Area Connection** icon and select the **Properties** item.
- Select the **Internet Protocol (TCP/IP)** item from the list provided and click the **Properties** button.
- Set the computer to “Obtain a relay address automatically” as shown.



If the computer is used to connect to the Internet, re-enable any proxy server settings after the computer has been disconnected from the G30 relay.

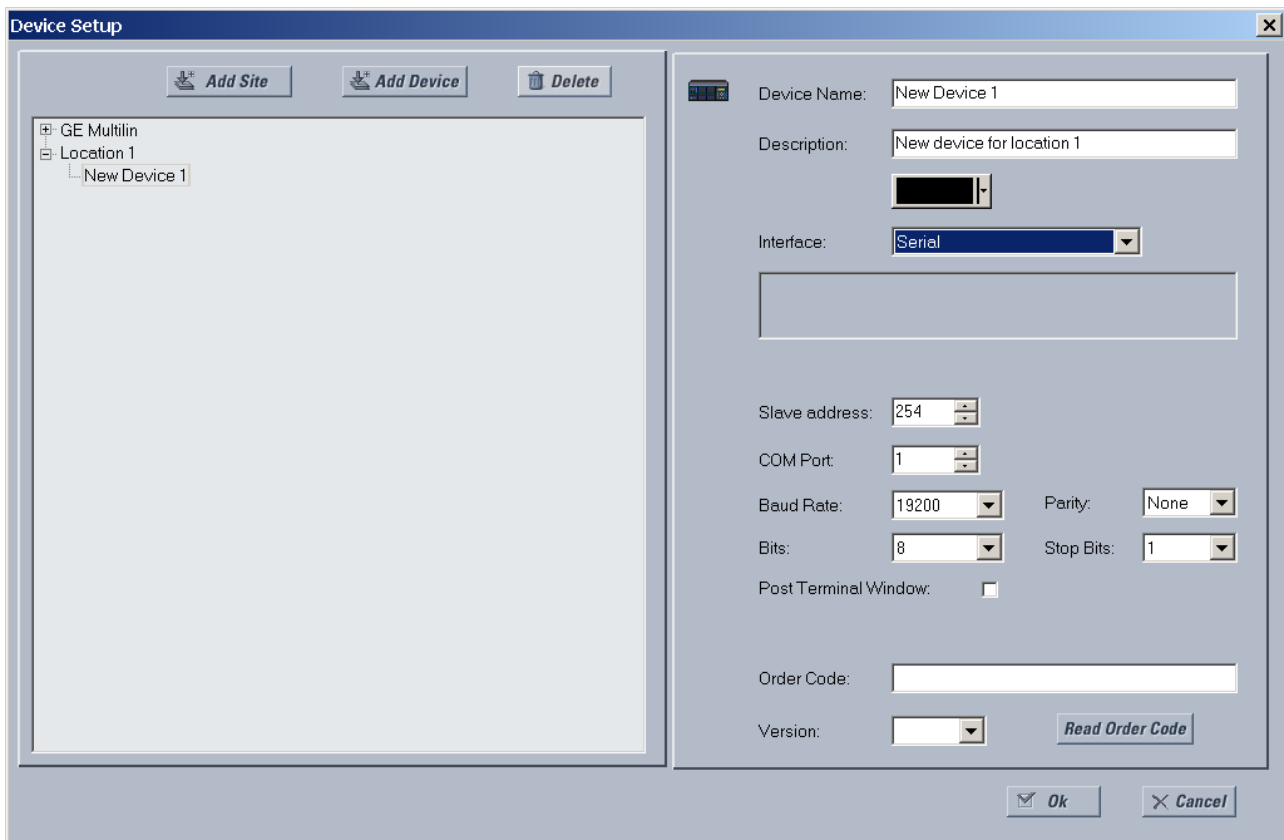
### 3.7.2 Configure serial connection

Two options are possible: local connection between computer and front RS232 port, and remote connection using the rear RS485 terminals.

To use the RS485 terminals at the back of the relay, a GE Grid Solutions F485 converter (or compatible RS232-to-RS485 converter) is required. See the F485 instruction manual for details.

1. Connect the computer to the F485 and the F485 to the RS485 terminal on the back of the UR device. Or connect the computer to the RS232 port on the front of the relay.
2. Start the EnerVista UR Setup software, or in EnerVista Launchpad select the UR device to start the software.
3. Click the **Device Setup** button. The window opens.
4. Click the **Add Site** button. A new category is added. Enter a site name in the **Site Name** field. Optionally add a short **Description** of the site. This example uses "Location 1" as the site name.
5. Click the **Add Device** button. A new device is added.
6. Enter a name in the **Device Name** field, up to 15 characters, and optionally add a **Description** of the site. The **Color** is for the text in the device list in the Online Window.
7. Select "Serial" from the **Interface** drop-down list. Interface parameters display that must be entered for serial communications. Try to load automatically the fields by clicking the **Read Order Code** button.

Figure 3-68: Configuring serial communication



8. Enter the COM port used by the computer, the baud rate, and parity settings from the front panel **SETTINGS** ⇒ **PRODUCT SETUP** ⇒ **COMMUNICATIONS** ⇒ **SERIAL PORTS** menu, and the relay slave address setting from the front panel **SETTINGS** ⇒ **PRODUCT SETUP** ⇒ **COMMUNICATIONS** ⇒ **MODBUS PROTOCOL** ⇒ **MODBUS SLAVE ADDRESS** menu in their respective

fields.

**Baud Rate** — Typically 19200 bits per second (bps) for RS232, and higher for RS485. Both modems need to use the same rate, meaning at the computer and the G30 ends.

**Parity** — Set to None if unsure

**Bits** — Set to 8 if unsure

**Stop Bits** — Set to 1 if unsure

**Post Terminal Window** — Enable this option if you have a Schweitzer Engineering (SEL) SEL-203x Communications Processor, such as an SEL-2030 or SEL-2032. This option enables display of a terminal window to allow interaction with the other device.

9. Click the **Read Order Code** button to connect to the G30 and upload the order code to the EnerVista software. If a communications error occurs, ensure that the EnerVista software serial communications values entered in the previous step correspond to the relay setting values, and also ensure that the same IP address is not assigned to multiple G30 ports.
10. Click the **OK** button when the relay order code has been received. The new site and device are added to the Online Window.

The device has been configured for serial communications. Proceed to the Connect to the G30 section to begin communication.

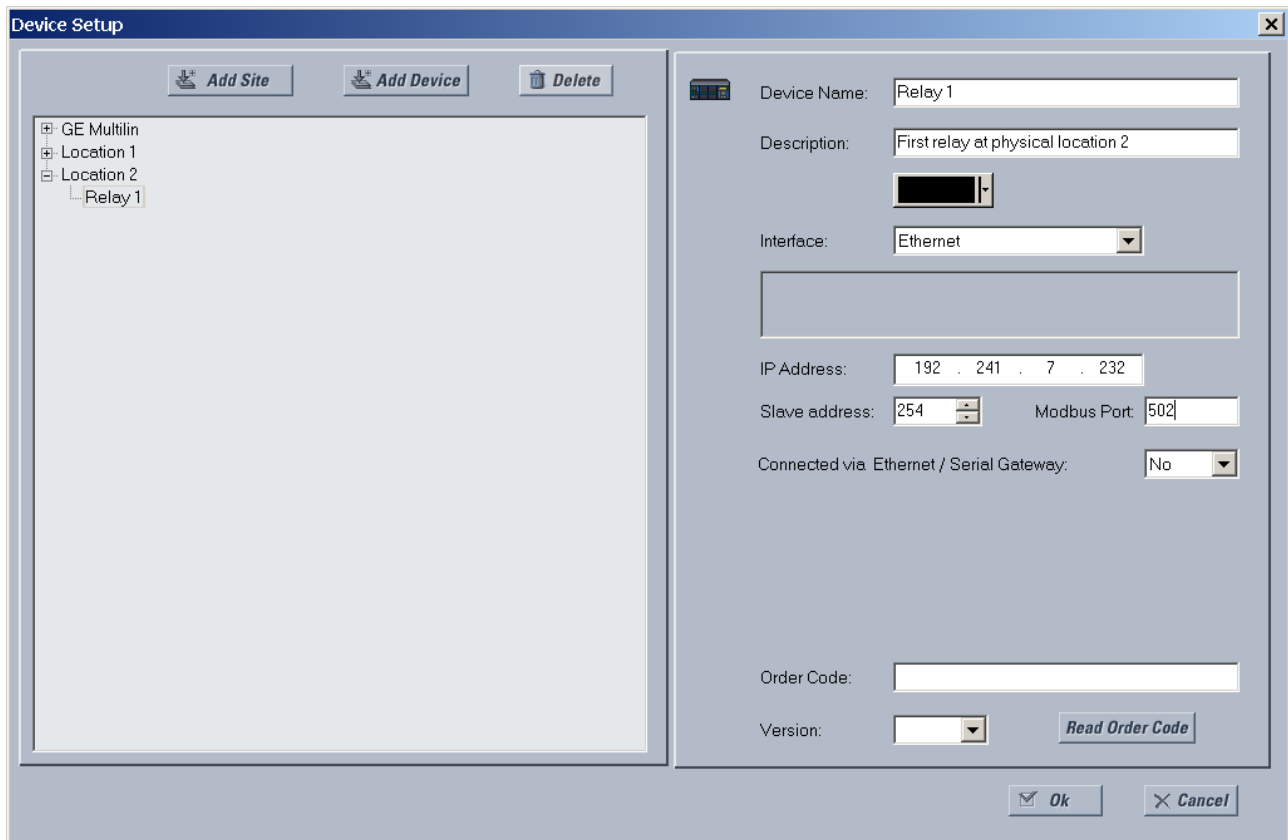
### 3.7.3 Configure Ethernet connection

You connect the Ethernet cable, define a site in the software, then add the relay as a device for the site.

The Ethernet cable can be connected from the relay to an Ethernet network or directly to the computer. The computer and UR device must be on the same subnet.

1. Connect the Ethernet network cable and any SFP supplied with the G30 to the Ethernet port on the back of the device.
2. Start the EnerVista UR Setup software, or in EnerVista Launchpad select the UR device to start the software.
3. Click the **Device Setup** button. The window opens.
4. Click the **Add Site** button. A new category is added. Enter a site name in the **Site Name** field. Optionally add a short **Description** of the site. This example uses "Location 1" as the site name.
5. Click the **Add Device** button. A new device is added.
6. Enter a name in the **Device Name** field, up to 15 characters, and optionally add a **Description** of the site. The **Color** is for the text in the device list in the Online Window.
7. Select "Ethernet" from the **Interface** drop-down list. This displays a number of interface parameters that must be entered for Ethernet functionality.

Figure 3-69: Configuring Ethernet communication



8. Enter the relay **IP Address**, which can be viewed on the device front panel under **SETTINGS** ⇒ **PRODUCT SETUP** ⇅ **COMMUNICATIONS** ⇅ **NETWORK** ⇒ **IP ADDRESS**. Once the IP address is entered, try to load automatically the fields by clicking the **Read Order Code** button.
9. Enter the relay **Slave address** and **Modbus Port** address values from the settings in the front panel **SETTINGS** ⇒ **PRODUCT SETUP** ⇅ **COMMUNICATIONS** ⇅ **MODBUS PROTOCOL** menu.
10. If using a gateway to connect to the device, select **Yes** from the drop-down list.
11. Click the **Read Order Code** button to connect to the G30 device and upload the order code. If the device was entered already, a message displays "Device 'x' is also using IP address...." If a communications error occurs, ensure that the values entered in the previous steps correspond to the relay setting values, and also ensure that the same IP address is not assigned to multiple G30 ports.
12. Click the **OK** button when the relay order code has been received. The new site and device are added to the Online Window.

The device has been configured for Ethernet communications. Proceed to the Connect to the G30 section to begin communications.

### 3.7.4 Configure modem connection

A modem connection allows a computer to communicate with a UR device over phone lines.

Two modems are required. One modem is connected to the UR device, either by connecting the serial cable to the front panel port or through a RS485 box to the rear terminals of the UR device. The second modem is connected to the computer that initiates the connection.

To add a UR device for modem connections:

1. Connect the modems to the computer and UR.

2. Start the EnerVista UR Setup software, or in EnerVista Launchpad select the UR device to start the software.
3. Click the **Device Setup** button. The window opens.
4. Click the **Add Site** button. A new category is added. Enter a site name in the **Site Name** field, such as London East. Optionally add a short **Description** of the site, such as the address or intersection.
5. Click the **Add Device** button. A new device is added.
6. Enter a name in the **Device Name** field, up to 15 characters, and optionally add a **Description** of the site. The **Color** is for the text in the device list in the Online Window.
7. Select "Modem" from the **Interface** drop-down list. This displays a number of interface parameters that must be entered.
8. Select "Generic Modem" from the **Modem Name** drop-down list, then enter the **Phone Number** to dial to establish communication with the remote modem.  
**Post Terminal Window** — Enable this option if you have a SEL-203x Communications Processor, such as an SEL-2030 or SEL-2032. It enables display of a terminal window to allow interaction with the other device.
9. Once the phone number is entered, try to load automatically the device information by clicking the **Read Order Code** button.
10. Click the **OK** button when the relay order code has been received. The new device is added to the Online window. The UR device has been added to the software.

### 3.7.5 Automatic discovery of UR devices

The EnerVista UR Setup software can find and communicate to all UR-family devices located on an Ethernet network.

Using the **Discover** button in the **Device Setup** window, a single click of the mouse triggers the software to detect any URs located on the network. This is done by searching a range of IP addresses based on the subnet mask of the computer. When a UR device is detected, the EnerVista UR Setup software proceeds to configure all settings and order code options in the window. This feature allows the user to identify and interrogate all UR devices at a location.

Examples of address ranges are as follows:

- If the host has an IP address of 3.94.247.10 and its subnet mask is 255.255.252.0, then the host's subnet is 3.94.244.0, and the possible IP addresses in this subnet are
  - 3.94.244.1 to 254
  - 3.94.245.1 to 254
  - 3.94.246.1 to 254
  - 3.94.247.1 to 254
 The discover function scans all those possible IP addresses to detect UR relays.
- If the host has an IP address of 3.94.247.145 and its subnet mask is 255.255.255.128, then the host's subnet is 3.94.247.128, and the discover function scans IP addresses of 3.94.247.128 to 3.94.248.254 for UR relays

To automatically add UR devices:

1. In the EnerVista software, click the **Device Setup** button. The window opens.
2. Click the **Discover** button. The software searches for UR devices on the computer subnet and adds any found to the Online Window area. If a required device is not found, add it manually as outlined earlier.

Figure 3-70: Discover button to detect UR devices in network



## 3 3.8 Connect to the G30

There are four ways to connect to the device, as follows:

- RS232 or USB port (outlined here)
- RS485 port
- Ethernet port (outlined here)
- LAN

When unable to connect because of an "ACCESS VIOLATION," access **Device Setup** and refresh the order code for the device.

When unable to connect, ensure that the same IP address is not assigned to multiple G30 ports, for example under **Settings > Product Setup > Communications > Network**.

If still unable to connect, try unplugging and replugging the Ethernet connection. If that does not work, try to ping the device from the computer, and if unsuccessful, restart the computer.



NOTE

When multiple computers are connected to a G30 device, EnerVista settings windows are not updated automatically. They are refreshed when re-opened. If a user changes a setting on one computer, the other users need to refresh the display by closing and opening the settings window to see the change. To ensure that current settings are always viewed, close settings windows when not in use so that they are up-to-date when next accessed.

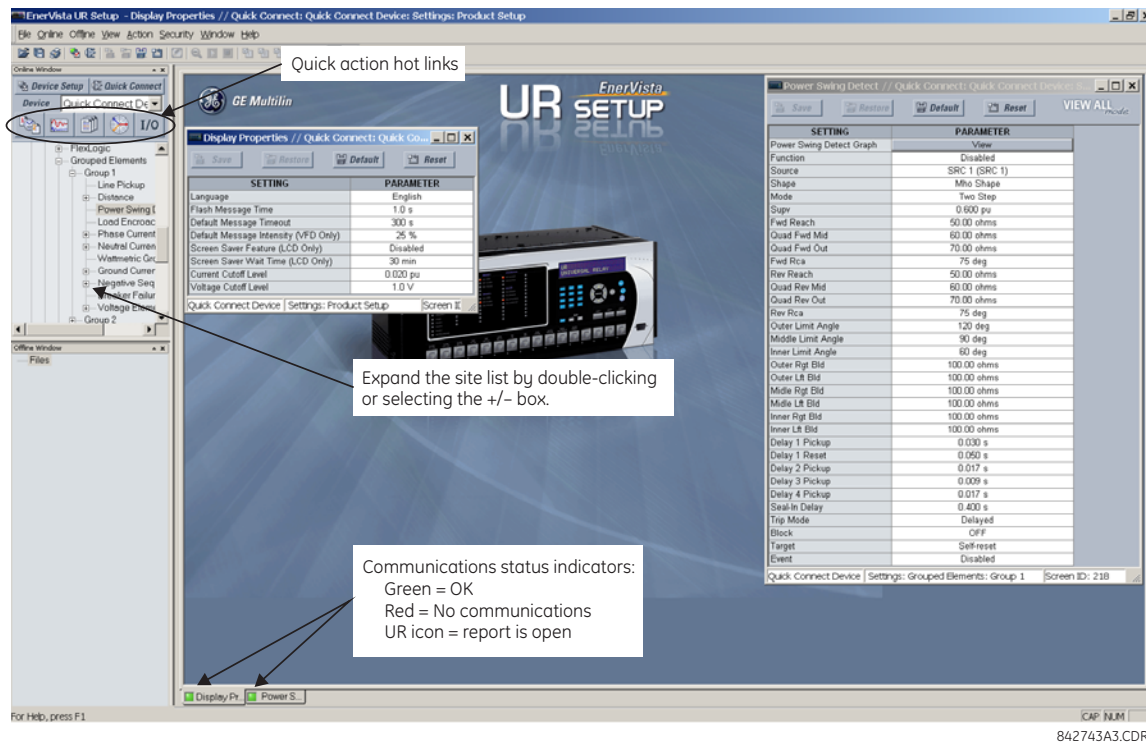
### 3.8.1 Connect to the G30 in EnerVista

For information on using the EnerVista software, see the Interfaces chapter.

To access the relay in EnerVista:

1. Open the **Settings > Product Setup > Display Properties** window as shown. The window opens with a status indicator on the lower left of the EnerVista UR Setup window.

Figure 3-71: EnerVista window



2. If the status indicator is red, verify that the Ethernet network cable is properly connected to the Ethernet port on the back of the relay and that the relay has been properly set up for communication.
3. If a relay icon appears in place of the status indicator, then a report (such as an oscillography or event record) is open. Close the report to re-display the green status indicator.
4. The Display Properties settings can now be viewed, edited, or printed.

### 3.8.1.1 Quick action hot links

The EnerVista UR Setup software has several quick action buttons to provide instant access to several functions that are performed often when using URs. From the online window, users can select the relay to interrogate from a pull-down window, then click the button for the action to perform. The following quick action functions are available:

- View the event record
- View the last recorded oscillography record
- View the G30 protection summary
- View all of the G30 metering values
- View the status of all G30 inputs and outputs
- Generate a service report

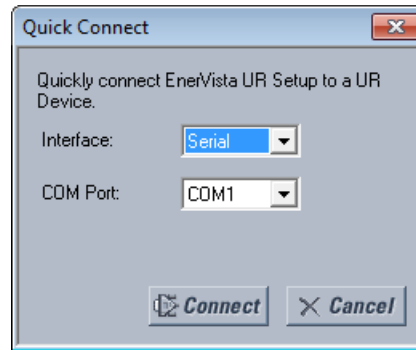
## 3.8.2 Use Quick Connect via front RS232 port

This feature applies to the enhanced and basic front panels.

To connect to the UR from a computer using a serial cable:

1. Connect an RS232 serial cable to the computer and the front panel RS232 port. For example, use a USB-to-serial RS232 DB9M converter cable when connecting to the USB port on the computer.
2. Start the EnerVista UR Setup software, or in EnerVista Launchpad select the UR device to start the software.
3. Click the **Quick Connect** button. The window opens.

Figure 3-72: Quick Connect window to access a device



3

4. Select the serial **Interface** and the communications port (**COM Port**) from the drop-down lists, then click **Connect**. The COM Port is that of the computer.
5. The EnerVista software creates a site named “Quick Connect” with a corresponding device also named “Quick Connect” and displays them in the Online Window. Expand the sections to view data directly from the UR device. Use the **Device Setup** button to change the site name.

Each time that the EnerVista UR Setup software is initialized, click the **Quick Connect** button to establish direct communications to the G30. This ensures that configuration of the EnerVista UR Setup software matches the G30 model number.

### 3.8.3 Use Quick Connect via front USB port

This feature applies to the graphical front panel.

To connect to the UR from a computer using a USB cable:

1. Connect the cable to the computer and the front panel USB port (square connector).
2. Start the EnerVista UR Setup software, or in EnerVista Launchpad select the UR device to start the software.
3. Click the **Quick Connect** button to open the window.
4. Select the USB **Interface** and the “GE Virtual Serial Port” driver from the drop-down list, then click **Connect**. If the GE driver does not display, it means that the USB cable was connected on Windows 10 when upgrading the UR software. You need to re-install the EnerVista software with the USB cable disconnected.
5. The EnerVista software creates a site named “Quick Connect” with a corresponding device also named “Quick Connect” and displays them in the Online Window. Expand the sections to view data directly from the UR device. Use the **Device Setup** button to change the site name.

Each time that the EnerVista UR Setup software is initialized, click the **Quick Connect** button to establish direct communications to the G30. This ensures that configuration of the EnerVista UR Setup software matches the G30 model number.

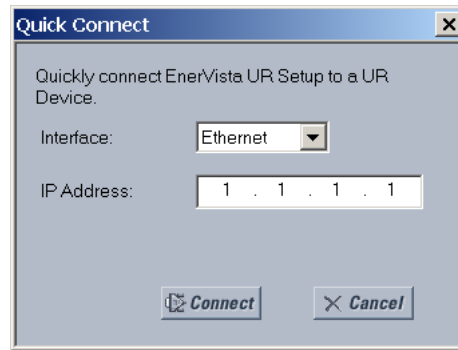
### 3.8.4 Use Quick Connect via a rear Ethernet port

To connect to a UR using an Ethernet cable:

1. In the EnerVista software, click the **Quick Connect** button. The window opens.



Figure 3-73: Quick Connect window for Ethernet connection



2. Select the **Ethernet** interface and enter the IP address assigned to the G30, then click the **Connect** button. The EnerVista UR Setup software creates a site named "Quick Connect" with a corresponding device also named "Quick Connect" and displays them in the Online Window.
3. Expand the sections to view data directly from the G30 device. Use the **Device Setup** button to change the site name. Each time that the EnerVista software is initialized, click the **Quick Connect** button to establish direct communications to the G30. This ensures that configuration of the EnerVista UR Setup software matches the G30 model number.

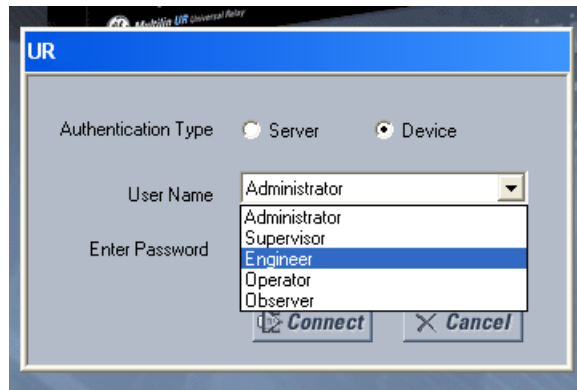
## 3.9 Set up CyberSentry and change default password

If and when first using CyberSentry security, use the following procedure for set up.

1. Log in to the relay as Administrator by using the **VALUE** keys on the front panel or through EnerVista connected serially (so that no IP address is required). If logging in through EnerVista choose Device authentication (see figure). Enter the default password "ChangeMe1#". Note that the "Lock relay" setting needs to be disabled in the **Security > Supervisory** menu. When this setting is disabled, configuration and firmware upgrade are possible. By default, this setting is disabled.
2. Enable the Supervisor role if you have a need for it.
3. Make any required changes in configuration, such as setting a valid IP address for communication over Ethernet.
4. Log out of the Administrator account by choosing None.

Next, device or server authentication can be chosen on the login screen, but the choice is available only in EnerVista. Use Device authentication to log in using the five pre-configured roles (Administrator, Supervisor, Engineer, Operator, Observer, or Administrator and Supervisor when Device authentication is disabled). When using a serial connection, only Device authentication is supported. When Server authentication is required, characteristics for communication with a RADIUS server must be configured on the UR. This is possible only through the EnerVista software. The RADIUS server itself also must be configured. At the end of this instruction manual, the appendix called RADIUS Server Configuration gives an example of how to set up a simple RADIUS server. Once both the RADIUS server and the parameters for connecting the UR to the server have been configured, you can choose Server authentication on the login screen of EnerVista.

Figure 3-74: Login screen for CyberSentry



3

During the commissioning phase, you have the option to bypass the use of passwords. Do so by enabling the **Bypass Access** setting under **Settings > Product Setup > Security > Supervisory**. Be sure to disable this bypass setting after commissioning the device.

You can change the password for any role either from the front panel or through EnerVista. If using EnerVista, navigate to **Settings > Product Setup > Security**. Change the **Local Administrator Password**, for example. It is strongly recommended that the password for the Administrator be changed from the default. Changing the passwords for the other three roles is optional.

## 3.10 Import settings

The following file types can be imported:

- URS — UR settings file (firmware version 7.3x or earlier)
- IID — Instantiated IED capability description file — Actual settings on UR
- CID — Configured IED description file — Settings sent to the UR (may or may not be actual settings). When using IEC 61850, network settings can also be configured by accepting a CID file that includes them, as long as the IP address of at least one port is manually configured in the relay before the CID file is sent and the IP address matches that in the file.

The import is done in the Offline Window area.

To import a settings file:

1. In the Offline Window area, right-click the device and select the **Add Device from File** option. The device is that from which you want to import settings.
2. If required, change the **Files of type** drop-down list.
3. Select the file to import.

To apply the settings to a live device:

1. Drag-and-drop the device entry from the Offline Window area to its entry in the Online Window area. Individual settings also can be dragged and dropped between Online and Offline Window areas. The order codes must match.

This is what happens:

- CID — For version 7.30 or later, a new URS file generates and moves into a new device folder, generating SCL files from the new URS file. Files in the folder have new time stamps. The CID file retains its time stamp.
- URS — When not IEC 61850 and version is lower than 7.30, the file is added and time stamp is unchanged. When clicking in the software on the tree element, a device folder is created, the original file moves into it, and time stamp is on the URS file is retained.

When IEC 61850 and version is 7.30 or later, the file is added and time stamp is unchanged. When clicking in the software on the tree element, a device folder is created, the original file moves into it, SCL files are generated there, and the "Last modified" time stamp on the URS file changes.

---

## 3.11 Connect to D400 gateway

A GE Multilin D400 Substation Gateway can be used to collect data from UR devices in a local area network (LAN). It collects metering, status, event, and fault report data from serial or LAN-based intelligent substation devices, and it pre-processes the data. The D400 supports up to 16 serial and eight network connections, with multiple devices possible on each serial connection. Up to 10 concurrent file transfer sessions are possible, meaning data for up to 10 URs can be transferred at the same time and any additional IEDs are queued on a first-come-first-served basis. The D400 can then upload files to a demilitarized zone (DMZ) server at the enterprise level.

Setup is as follows. For UR devices with the CyberSentry software option, when there is a need to retrieve periodically the logs from the UR securely without a human interface, the following approach can be used. See the D400 manual for configuration details to achieve it.

A UR in the substation can authenticate a user either connecting to a RADIUS server or on the device itself. This depends on the user name used for authentication on a connection. The D400 connects to the UR device using an Ethernet, USB, or serial port on the UR. The Ethernet connection can be ST or RJ-45 type. The serial connection can be RS232 or RS485. At the other end, a cable attaches to the rear of D400. Use the D400 software to configure a serial or network communication/connection for the UR, then to configure the IED device blocks/clients for the UR, and then to configure record retrieval. Once configured, the UR and D400 use a keyfile authentication mechanism to establish communication.

For UR devices with the IEC 61850 software option, also use the D400 IEC 61850 Loader software.

When a D400 detects new files available for download from a UR, it connects to the UR and reads the files via sFTP protocol. The following files can be transferred:

- Oscillography files
- Event records
- Log files
- Configuration (setting) files

The D400 information is viewable in its software and in a web browser.

### 3.11.1 Oscillography files

These are stored in COMTRADE format in the D400 folder system using the UR site and device name.

### 3.11.2 Event records

These are stored as the EVT.TXT file in the D400 folder system using the UR site and device name.

### 3.11.3 Log files

Log files can be retrieved for UR 7.0 and later. The following file types are possible, stored in the D400 folder system using the UR site and device name:

- `factory_event.txt` — Information about change methods and origins. Saved with a "\_YYMMDDhhmmss" retrieval time stamp, for example `FACTORY_EVENT_170525183124.TXT`.
- `setting_changes.log` — Information on what settings have been changed. Saved with a "\_YYMMDDhhmmss" retrieval time stamp, for example `SETTING_CHANGES_170525183124.TXT`.

### 3.11.4 Setting files

These are the configuration/settings files in the IEC 61850 SCL/IID format. The ur.iid file is saved with a "\_YYMMDDhhmmss" retrieval time stamp, for example ur\_170525183124.iid. It is stored in the D400 folder system using the UR site and device name.

# G30 Generator Protection System

## Chapter 4: Interfaces

This chapter explains the EnerVista software interface, the front panel interface, logic diagrams, and Engineer interface for logic design and monitoring.

---

### 4.1 EnerVista software interface

#### 4.1.1 Introduction

The EnerVista UR Setup software provides a single facility to configure, monitor, maintain, and troubleshoot relays connected over local or wide-area networks. It can be used while disconnected (offline) or connected (online) to a UR device. In offline mode, settings files can be created for eventual downloading to the device. In online mode, communication with the device is real-time.

The EnerVista UR Setup software is provided with every G30. This chapter outlines the EnerVista software interface. The EnerVista UR Setup help file in the software also provides details for getting started and using the software interface.

#### 4.1.2 Settings files

The EnerVista software supports the following three ways of handling changes to relay settings:

- In offline mode (relay disconnected) to create or edit relay settings files for later transfer to relays
- While connected to a relay to modify relay settings, and then save the settings to the relay
- Create/edit settings files and then write them to the relay while connected to the relay

See the back up section in the Maintenance chapter for instructions on how to create a settings file either offline or online.

Settings files are organized on the basis of file names assigned by the user. A settings file contains data pertaining to the following types of relay settings:

- Device definition
- Product setup
- System setup
- FlexLogic
- Grouped elements
- Control elements
- Inputs/outputs

- Remote resources
- Testing

Factory default values are supplied and can be restored after any changes.

The following communications settings are not transferred to the G30 with settings files:

- Modbus Slave Address
- Modbus TCP Port Number
- RS485 COM2 Baud Rate
- RS485 COM2 Parity
- COM2 Minimum Response Time
- COM2 Selection
- RRTD Slave Address
- RRTD Baud Rate
- IP Address (see end of previous chapter for information)
- IP Subnet Mask
- IP Routing

When a settings file is loaded to a G30 that is in-service, the following sequence occurs:

1. The G30 takes itself out of service.
2. The G30 issues a UNIT NOT PROGRAMMED major self-test error.
3. The G30 closes the critical fail contact.

The Maintenance chapter outlines how to use a settings file in the .urs format for backup and restore.

### 4.1.3 Event viewing

In online or offline mode, you can view and analyze data generated by triggered parameters as follows:

- **Event recorder** — The event recorder captures contextual data associated with the last 1024 events, listed chronologically from most recent to oldest
- **Oscillography** — The oscillography waveform traces and digital states are used to provide a visual display of power system and relay operation data captured during specific triggered events

Event records are viewable at software and device-specific levels. Access the former under **Admin > Event Log > View**. Access the latter under **Actual Values > Records > Event Record**.

Event record entries for CyberSentry are explained in the next chapter. The following table outlines some software-level entries.

**Table 4-1: Event record descriptions**

Event	Description
EnerVista UR Setup SESSION STARTED	The EnerVista software was launched
Language was changed.	The user changed the software language using the <b>View &gt; Language</b> menu item
DEFAULT USERS CREATED	The user management window was launched using the <b>Admin &gt; User Management</b> menu item
: Successful upload of firmware END Firmware verified Firmware uploaded Firmware erased START: Upload new firmware	The firmware on a device was upgraded
EnerVista UR Setup EVENT LOG CLEARED	The event record was cleared. All event records were deleted using the <b>Admin &gt; Event Log &gt; Clear</b> menu item.

### 4.1.4 File support

The following support applies, where the Settings List is at the bottom left and the Site List is at the top left of the EnerVista window:

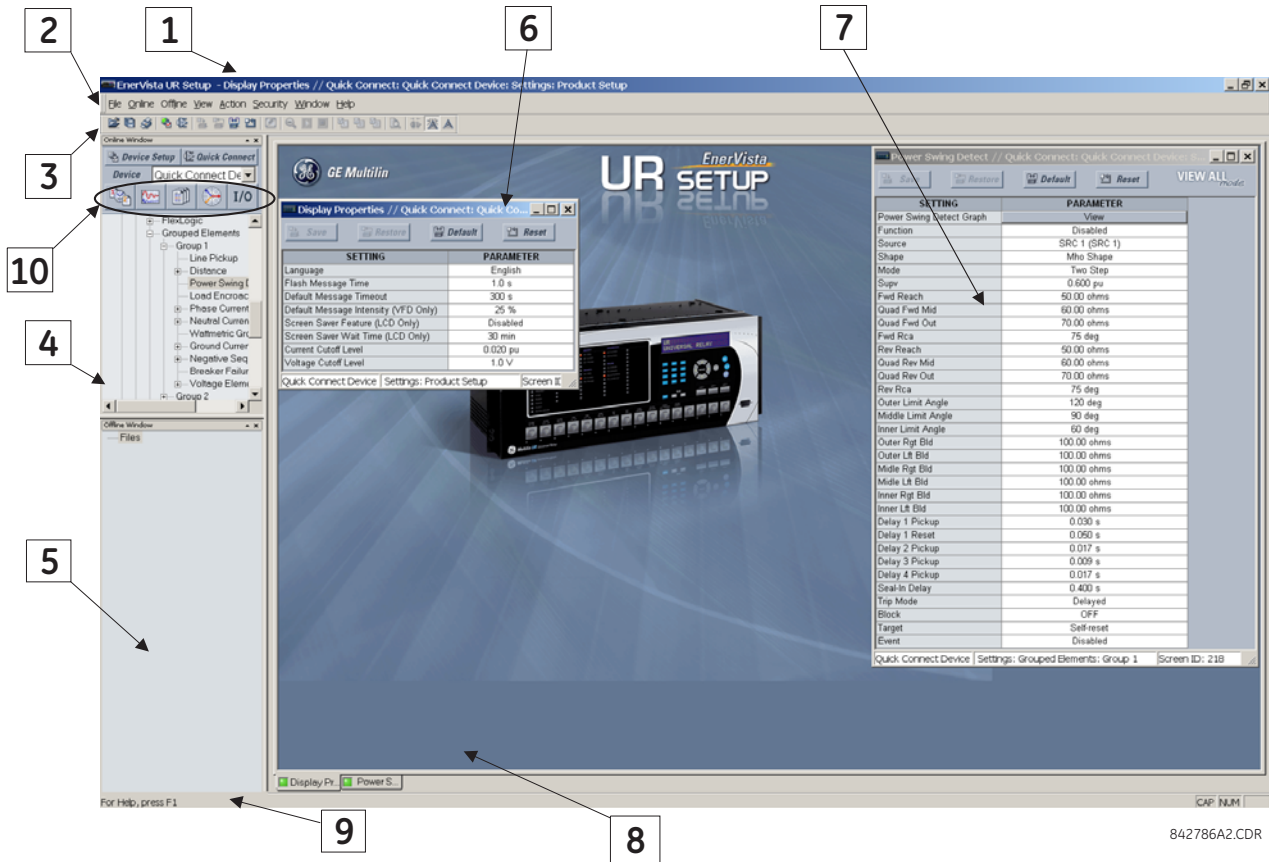
- **Execution** — Any EnerVista UR Setup file that is opened launches the application or provides focus to the already opened application. If the file was a settings file (has a .urs extension) that had been removed from the Settings List navigation menu, it is added back to the menu.
- **Drag and Drop** — The device settings and individual settings can be dragged and dropped between the Online and Offline Window areas. Also, any Windows Explorer directory folder is a file drag source and drop target.  
New files that are dropped into the Offline Window are added to the tree, which is automatically sorted alphabetically with respect to settings file names. In the Online Window, files or individual menu items that are dropped in the selected device menu are sent automatically to the online device.

### 4.1.5 EnerVista main window

The EnerVista UR Setup software window has the following components:

1. Title bar that shows the pathname of the active data view or the name of the software
2. Main window menu bar
3. Main window toolbar
4. Site list / online window area
5. Settings list / offline window area
6. Software windows, with common toolbar
7. Settings file data view windows, with common toolbar
8. Workspace area with data view tabs
9. Status bar
10. Quick action hot links

Figure 4-1: EnerVista UR Setup software window

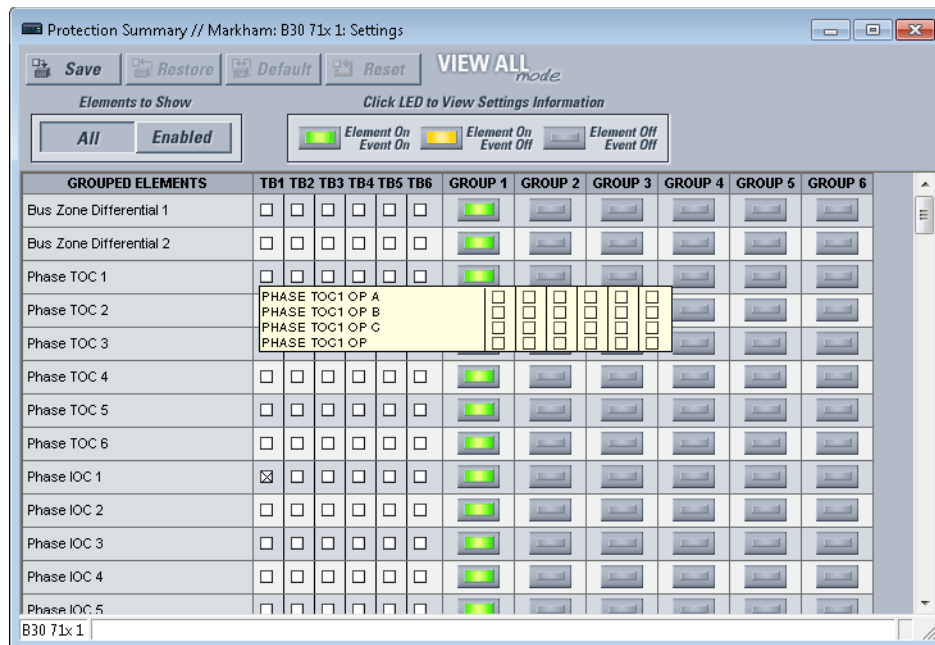


### 4.1.6 Protection summary window

The Protection Summary is a graphical user interface to manage elements, such as enabling and disabling them. Access it under **Settings > Protection Summary**. See the Settings chapter for information on use.



Figure 4-2: Protection Summary interface (B30 example shown)



### 4.1.7 Settings templates

Settings file templates simplify the configuration and commissioning of multiple relays that protect similar assets. An example is a substation that has 10 similar feeders protected by 10 UR F60 relays.

In these situations, typically 90% or greater of the settings are identical among devices. The templates allow engineers to configure and test these common settings, then lock them so that they are not available to users. For example, locked settings can be hidden from view for field engineers, allowing them to quickly identify and concentrate on specific settings.

The remaining settings (typically 10% or less) can be specified as editable and made available to field engineers installing the devices. These are settings such as protection element pickup values and CT and VT ratios.

The settings template mode allows the user to define which settings are visible in the software. Settings templates can be applied to both settings files (settings file templates) and online devices (online settings templates). The functionality is identical for both purposes.



Template mode is available in the English software only.

NOTE

Settings file conversion from previous firmware versions is supported.

#### 4.1.7.1 Enable the settings template

The settings file template feature is disabled by default. It can be enabled in offline or online mode.

The procedure outlines how to enable in offline mode the settings template for UR settings files.

1. Locate the settings file in the Offline Window area of the EnerVista UR Setup software. If not there, a file can be added from an online device by right-clicking it and selecting the **Add Device to Offline Window** option.
2. In the Offline Window area, right-click the selected device or settings file and select the **Template Mode > Create Template** option.

The settings file template is now enabled and the file menus display in light blue. The settings file is now in template editing mode. To undo the action, select **Template Mode > Remove Template**.

Alternatively, the settings template can be applied to online settings, as follows.

1. Locate the device in the Online Window area of the EnerVista UR Setup software.
2. Right-click the device and select the **Template Mode > Create Template** option. The software prompts for a template password. This password is required to use the template feature and must be at least four characters in length.

**Figure 4-3: Entering a settings file password**

3. Enter and re-enter the new password, then click **OK** to continue.  
The online settings template is now enabled. The device is now in template editing mode.

## 4

### 4.1.7.2 Edit the settings template

The settings template editing feature allows the user to specify which settings are available for viewing and modification in EnerVista UR Setup. By default, all settings except the FlexLogic equation editor settings are locked.

1. With the template already enabled, locate the device or settings file in the Online or Offline Window area in the software.
2. Right-click the device or file and select the **Template Mode > Edit Template** option to verify or place the device in template editing mode (check mark beside option). If prompted, enter the template password then click **OK**.
3. Open the relevant settings window that contains settings to be specified as viewable.  
By default, all settings are specified as locked and displayed against a grey background. The icon on the upper right of the settings window indicates that the EnerVista software is in **EDIT mode**. The following example shows the phase time overcurrent settings window in edit mode.

**Figure 4-4: Settings template with all settings specified as locked**

PARAMETER	PHASE TOC1
Function	Enabled
Signal Source	SRC 1 (SRC 1)
Input	Phasor
Pickup	2.300 pu
Curve	IEEE Ext Inv
TD Multiplier	1.00
Reset	Instantaneous
Voltage Restraint	Disabled
Block A	OFF
Block B	OFF
Block C	OFF
Target	Self-reset
Events	Enabled

4. Specify the settings to make viewable by clicking them.  
A setting available to view displays with a yellow background.

Figure 4-5: Settings template with two settings specified as editable

PARAMETER	PHASE TOC1
Function	Enabled
Signal Source	SRC 1 (SRC 1)
Input	Phasor
Pickup	2.300 pu
Curve	IEEE Ext Inv
TD Multiplier	1.00
Reset	Instantaneous
Voltage Restraint	Disabled
Block A	OFF
Block B	OFF
Block C	OFF
Target	Self-reset
Events	Enabled

- Click the **Save** button to save changes to the settings template.
- Continue through any other settings window to specify all viewable settings.  
The next time that the device/settings are accessed, only those specified as viewable/editable display in the menu hierarchy.

#### 4.1.7.3 Add password protection to a template

GE recommends that templates be saved with password protection to maximize security.



When templates are created for online settings, the password is added during the initial template creation step. It does not need to be added after the template is created.

To add password protection to a settings file template:

- In the Offline Window area, right-click the device and select the **Template Mode > Password Protect Template** option.

The software prompts for a template password. This password must be at least four characters in length.

- Enter and re-enter the new password, then click **OK** to continue.

The settings file template is now secured with password protection.

#### 4.1.7.4 View the settings template

Once all necessary settings are specified for viewing, users are able to view the settings template on the online device or settings file. There are two ways to specify the settings view with the settings template feature:

- Display only those settings available for editing
- Display all settings, with settings not available for editing greyed-out

To display only the settings available for editing:

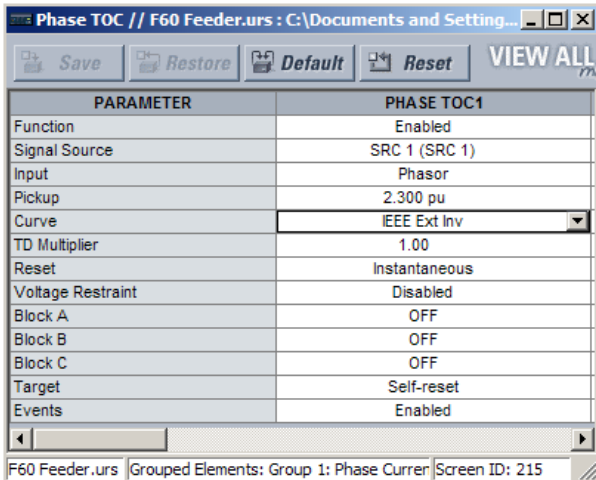
- Right-click the device in the Online or Offline Window area and apply the template by selecting the **Template Mode >**

**View In Template Mode** option.

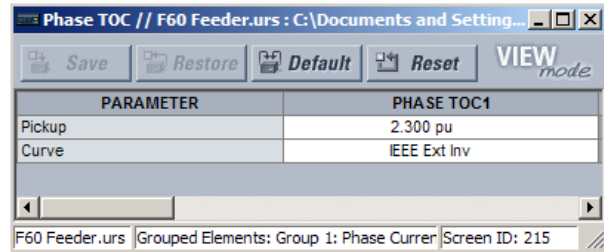
2. Enter the template password if prompted, then click **OK** to apply the template.

Once the template has been applied, users are limited to view and edit the settings specified by the template. The effect of applying the template to the phase time overcurrent settings is shown.

**Figure 4-6: Applying templates using the View in Template Mode command**



Phase time overcurrent settings window without template applied.

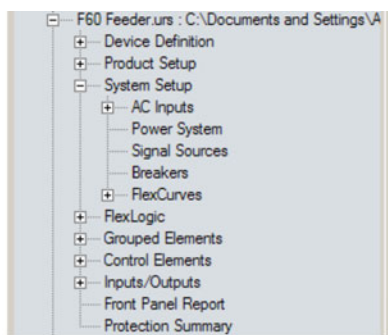


Phase time overcurrent window with template applied via the **Template Mode > View In Template Mode** command. The template specifies that only the **Pickup** and **Curve** settings be available.

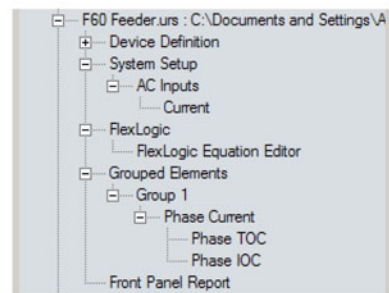
842858A1.CDR

Viewing the settings in template mode also modifies the settings menu, showing only the settings categories that contain editable settings. The effect of applying the template to a typical settings menu is shown as follows.

**Figure 4-7: Applying templates using the View in Template Mode settings command**



Typical settings tree view without template applied.



Typical settings tree view with template applied via the **Template Mode > View In Template Mode** command.

842860A1.CDR

Use the following procedure to display settings available for editing and settings locked by the template.

1. Right-click the device in the Online or Offline Window area and apply the template by selecting the **Template Mode > View All Settings** option.
2. Enter the template password then click **OK** to apply the template.

Once the template has been applied, users are limited to edit the settings specified by the template, but all settings are shown. The effect of applying the template to the phase time overcurrent settings is shown as follows.

Figure 4-8: Applying templates using the View All Settings command

PARAMETER	PHASE TOC1
Function	Enabled
Signal Source	SRC 1 (SRC 1)
Input	Phasor
Pickup	2.300 pu
Curve	IEEE Ext Inv
TD Multiplier	1.00
Reset	Instantaneous
Voltage Restraint	Disabled
Block A	OFF
Block B	OFF
Block C	OFF
Target	Self-reset
Events	Enabled

Phase time overcurrent settings window without template applied.

PARAMETER	PHASE TOC1
Function	Enabled
Signal Source	SRC 1 (SRC 1)
Input	Phasor
Pickup	2.300 pu
Curve	IEEE Ext Inv
TD Multiplier	1.00
Reset	Instantaneous
Voltage Restraint	Disabled
Block A	OFF
Block B	OFF
Block C	OFF
Target	Self-reset
Events	Enabled

Phase time overcurrent window with template applied via the **Template Mode > View All Settings** command. The template specifies that only the **Pickup** and **Curve** settings be available.

842859A1.CDR

#### 4.1.7.5 Remove the settings template

Once a settings template is removed, it cannot be reapplied and a new settings template needs to be defined before use.

1. Right-click the device in the Online or Offline Window area and select the **Template Mode > Remove Template** option.
2. Enter the template password if prompted and click **OK** to continue.
3. Confirm that you want to remove the template by clicking **Yes**.

The EnerVista software removes all template information and all settings are available.

### 4.1.8 Secure and lock FlexLogic equations

The UR allows users to secure some or all FlexLogic equations, preventing unauthorized viewing or modification of critical FlexLogic applications. This is accomplished using the settings template feature to lock individual entries within FlexLogic equations.

Secured FlexLogic equations remain secure when files are sent to and retrieved from any UR-series device.

Locking can be tied to the serial number too.

#### 4.1.8.1 Lock FlexLogic equations

To lock individual entries of a FlexLogic equation:

1. Right-click the settings file or online device and select the **Template Mode > Create Template** item to enable the settings template feature.
2. If prompted, enter the template password.
3. Select the **FlexLogic > FlexLogic Equation Editor** settings menu item.

By default, all FlexLogic entries are specified as viewable and display against a yellow background. The icon on the upper right of the window also indicates that EnerVista UR Setup is in **EDIT mode**.

4. Specify the entries to lock by clicking them.

The locked entries display a grey background as shown in the example.

Figure 4-9: Locking FlexLogic equation entries in Edit Mode

FLEXLOGIC ENTRY	TYPE	SYNTAX
View Graphic	View	View
FlexLogic Entry 1	Virtual Inputs On	Close HMI On (V11)
FlexLogic Entry 2	Virtual Inputs On	Close SCADA On (V12)
FlexLogic Entry 3	Contact Inputs On	Manual Close On(H5A)
FlexLogic Entry 4	OR	3 Input
FlexLogic Entry 5	Assign Virtual Output	= Close 52-1 (VO1)
FlexLogic Entry 6	Contact Inputs On	52-1 Closed On(H5C)
FlexLogic Entry 7	Contact Inputs On	52-1 Rack In On(H6A)
FlexLogic Entry 8	AND	2 Input
FlexLogic Entry 9	Protection Element	PHASE IOC1 OP
FlexLogic Entry 10	Protection Element	PHASE TOC1 OP
FlexLogic Entry 11	Protection Element	GROUND IOC1 OP
FlexLogic Entry 12	Protection Element	NEUTRAL IOC1 OP
FlexLogic Entry 13	OR	4 Input
FlexLogic Entry 14	AND	2 Input
FlexLogic Entry 15	Assign Virtual Output	= Trip 52-1 (VO2)
FlexLogic Entry 16	Protection Element	ANY MAJOR ERROR
FlexLogic Entry 17	POSITIVE ONE SHOT	1 Input
FlexLogic Entry 18	Protection Element	ANY MAJOR ERROR

4

- Click the **Save** button to save and apply changes to the settings template.
- Select the **Template Mode > View In Template Mode** option to view the template.
- Optionally apply a password to the template by right-clicking the device and selecting the **Template Mode > Password Protect Template** option.

Once the template has been applied, users are limited to view and edit the FlexLogic entries not locked by the template. The effect of applying the template to the FlexLogic entries is shown here.

Figure 4-10: Locking FlexLogic entries through settings templates

FLEXLOGIC ENTRY	TYPE	SYNTAX
View Graphic	View	View
FlexLogic Entry 1	Virtual Inputs On	Close HMI On (V11)
FlexLogic Entry 2	Virtual Inputs On	Close SCADA On (V12)
FlexLogic Entry 3	Contact Inputs On	Manual Close On(H5A)
FlexLogic Entry 4	OR	3 Input
FlexLogic Entry 5	Assign Virtual Output	= Close 52-1 (VO1)
FlexLogic Entry 6	Contact Inputs On	52-1 Closed On(H5C)
FlexLogic Entry 7	Contact Inputs On	52-1 Rack In On(H6A)
FlexLogic Entry 8	AND	2 Input
FlexLogic Entry 9	Protection Element	PHASE IOC1 OP
FlexLogic Entry 10	Protection Element	PHASE TOC1 OP
FlexLogic Entry 11	Protection Element	GROUND IOC1 OP
FlexLogic Entry 12	Protection Element	NEUTRAL IOC1 OP
FlexLogic Entry 13	OR	4 Input
FlexLogic Entry 14	AND	2 Input
FlexLogic Entry 15	Assign Virtual Output	= Trip 52-1 (VO2)
FlexLogic Entry 16	Protection Element	ANY MAJOR ERROR
FlexLogic Entry 17	POSITIVE ONE SHOT	1 Input

Typical FlexLogic™ entries without template applied.

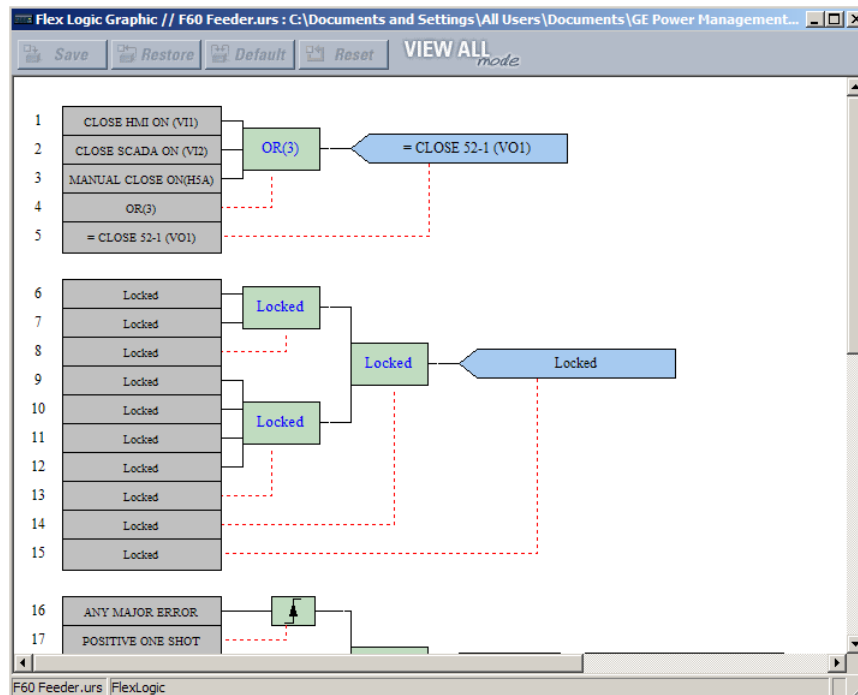
FLEXLOGIC ENTRY	TYPE	SYNTAX
View Graphic	View	View
FlexLogic Entry 1	Virtual inputs On	Close HMI On (V11)
FlexLogic Entry 2	Virtual inputs On	Close SCADA On (V12)
FlexLogic Entry 3	Contact inputs On	Manual Close On(H5A)
FlexLogic Entry 4	OR	3 Input
FlexLogic Entry 5	Assign Virtual Output	= Close 52-1 (VO1)
FlexLogic Entry 6	Locked	Locked
FlexLogic Entry 7	Locked	Locked
FlexLogic Entry 8	Locked	Locked
FlexLogic Entry 9	Locked	Locked
FlexLogic Entry 10	Locked	Locked
FlexLogic Entry 11	Locked	Locked
FlexLogic Entry 12	Locked	Locked
FlexLogic Entry 13	Locked	Locked
FlexLogic Entry 14	Locked	Locked
FlexLogic Entry 15	Locked	Locked
FlexLogic Entry 16	Protection Element	ANY MAJOR ERROR
FlexLogic Entry 17	POSITIVE ONE SHOT	1 Input
FlexLogic Entry 18	Protection Element	ANY MAJOR ERROR

Typical FlexLogic™ entries locked with template via the **Template Mode > View In Template Mode** command.

842861A1.CDR

The FlexLogic entries are also shown as locked in the graphical view and on the front panel display.

Figure 4-11: Secured FlexLogic in graphical view



#### 4.1.8.2 Lock FlexLogic equations to the serial number

A settings file and associated FlexLogic equations also can be locked to a UR serial number. Once FlexLogic entries in a settings file have been secured, use the following procedure to lock the settings file to a serial number. A serial number is viewable under **Actual Values > Product Info > Model Information**, the inside front panel, and the rear of the device.

1. Right-click the setting file in the Offline Window area and select the **Edit Device Properties** item. The window opens.

Figure 4-12: Settings file properties window

**Edit Device Properties**

Device Name: B30\_test\_v7.3\_T

Path: B30\_test\_v7.3\_T.urs : D:\Users\420001756\Desktop\UI

Relay Name: Relay-1

Order Code: B30-TD4-HLH-F8N-H6L-L8N-N6L-S8L-U6L-WXX-\_\_\_

Version: 7.3x

Description:

Serial # Lock:

Associate Device with Relay: No Device(s) found

Ok Cancel

2. Enter the serial number of the G30 device to lock to the settings file in the **Serial # Lock** field.
3. Click the **OK** button to apply the change. The serial number is not validated.

The settings file and corresponding secure FlexLogic equations are now locked to the G30 device specified by the serial number.

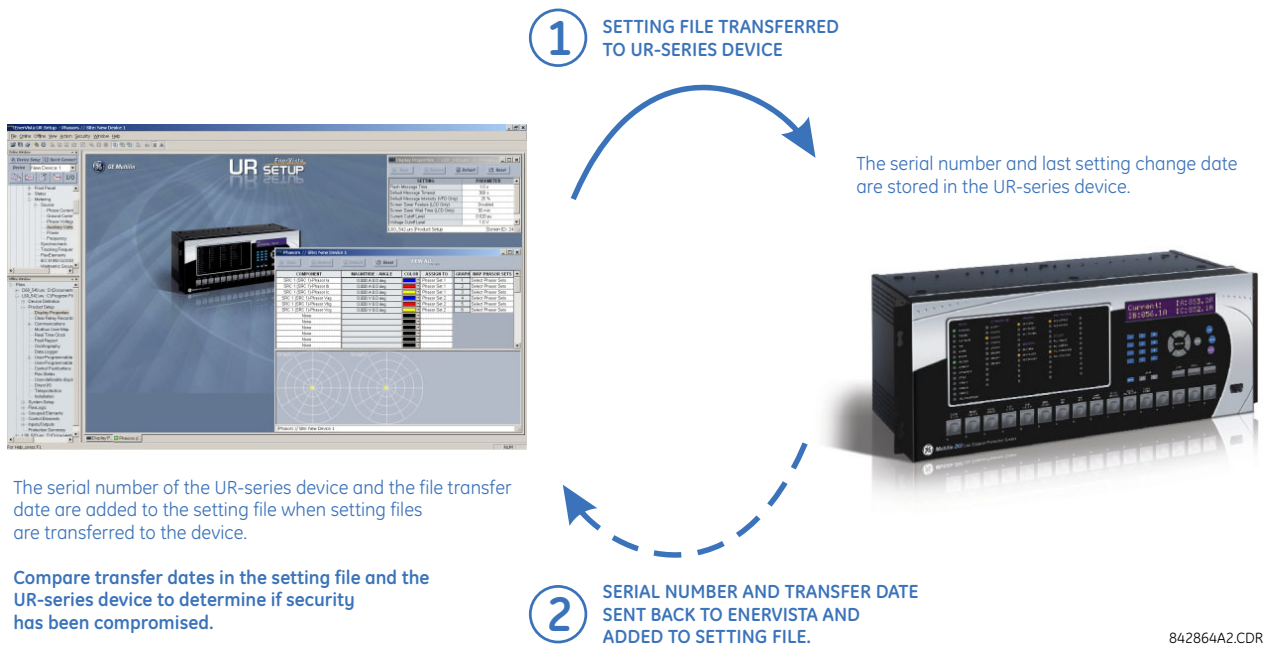
### 4.1.9 Settings file traceability

A traceability feature for settings files allows the user to quickly determine if the settings in a G30 device have been changed since the time of installation from a settings file. When a settings file is transferred to a G30 device, the date, time, and serial number of the G30 are sent back to EnerVista UR Setup and added to the settings file on the local computer. This information can be compared with the G30 actual values at any later date to determine if security has been compromised.

The traceability information is only included in the settings file if a complete settings file is either transferred to the G30 device or obtained from the G30 device. Any partial settings transfers by way of drag and drop do not add the traceability information to the settings file.



Figure 4-13: Settings file traceability



With respect to the figure, the traceability feature is used as follows.

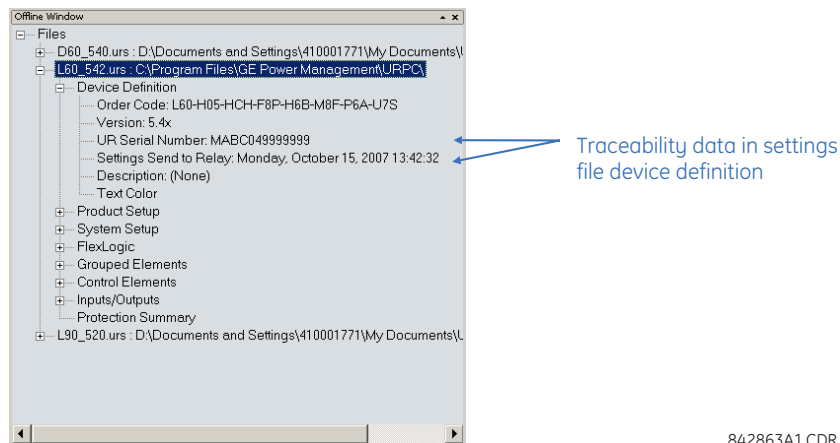
- The transfer date of a settings file written to a G30 is logged in the relay and can be viewed in the EnerVista software or the front panel display. Likewise, the transfer date of a settings file saved to a local computer is logged in the EnerVista software.
- Comparing the dates stored in the relay and on the settings file at any time in the future indicates if any changes have been made to the relay configuration since the settings file was saved.

#### 4.1.9.1 Settings file traceability information

The serial number and file transfer date are saved in the settings files when they are sent to a G30 device.

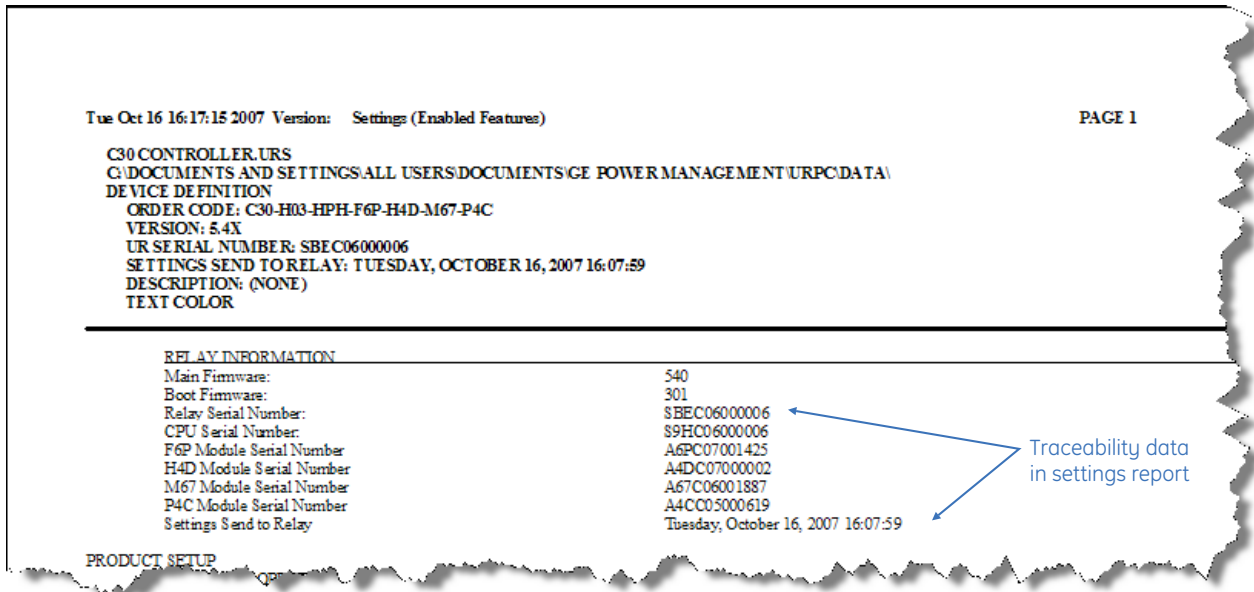
The G30 serial number and file transfer date are included in the settings file device definition within the EnerVista UR Setup offline window as shown in the example.

Figure 4-14: Device definition showing traceability data



This information is also available in printed settings file reports as shown in the example. A report is generated by right-clicking and selecting the **Print Settings** option.

Figure 4-15: Settings file report showing traceability data

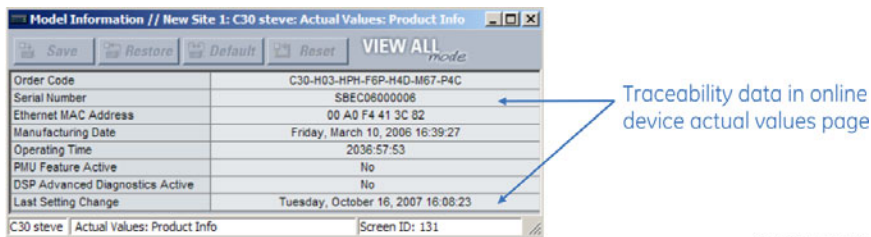


4

#### 4.1.9.2 Online device traceability information

The G30 serial number and file transfer date are available for an online device through the actual values. Select the **Actual Values > Product Info > Model Information** menu item within the EnerVista online window as shown in the example.

Figure 4-16: Traceability data in Actual Values window



842865A1.CDR

This information is also available from the front panel display through the following actual values:

ACTUAL VALUES ⇄ PRODUCT INFO ⇄ MODEL INFORMATION ⇄ SERIAL NUMBER

ACTUAL VALUES ⇄ PRODUCT INFO ⇄ MODEL INFORMATION ⇄ LAST SETTING CHANGE

#### 4.1.9.3 Additional traceability rules

The following additional rules apply for the traceability feature:

- If the user changes any settings within the settings file in the offline window, then the traceability information is removed from the settings file
- If the user creates a new settings file, then no traceability information is included in the settings file
- If the user converts an existing settings file to another revision, then any existing traceability information is removed from the settings file
- If the user duplicates an existing settings file, then any traceability information is transferred to the duplicate settings file

## 4.2 Front panel interface

This section explains use of the enhanced, basic, and graphical front panels.

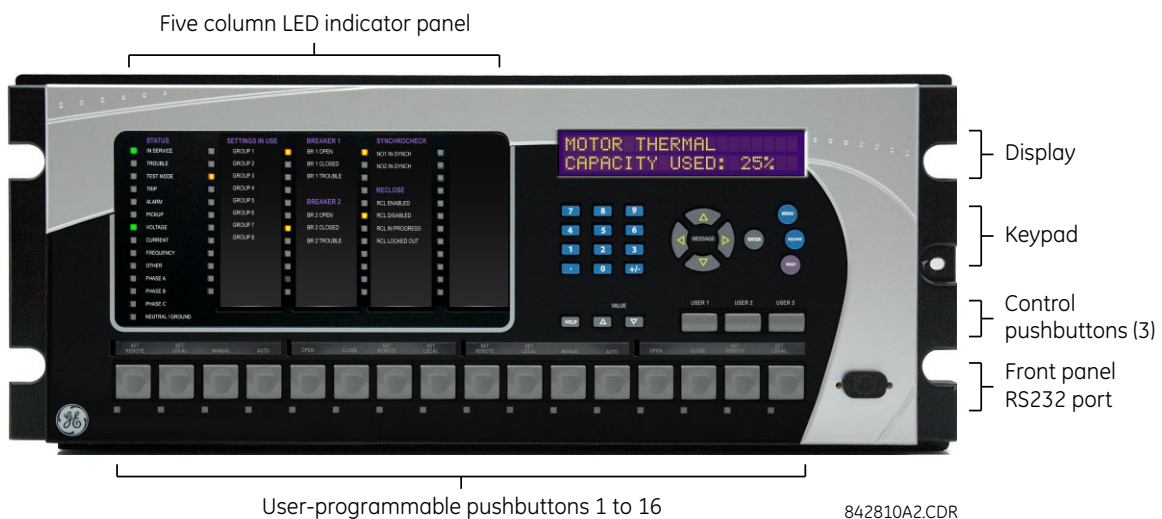
### 4.2.1 Front panel

#### 4.2.1.1 Enhanced front panel

The enhanced front panel consists of LED panels, an RS232 port, keypad, LCD display, control pushbuttons, and optional user-programmable pushbuttons.

The front panel is hinged to allow access to removable modules inside the chassis. The G30 enhanced front panel can be horizontal or vertical. The following figure shows the horizontal front panel.

Figure 4-17: Enhanced horizontal front panel

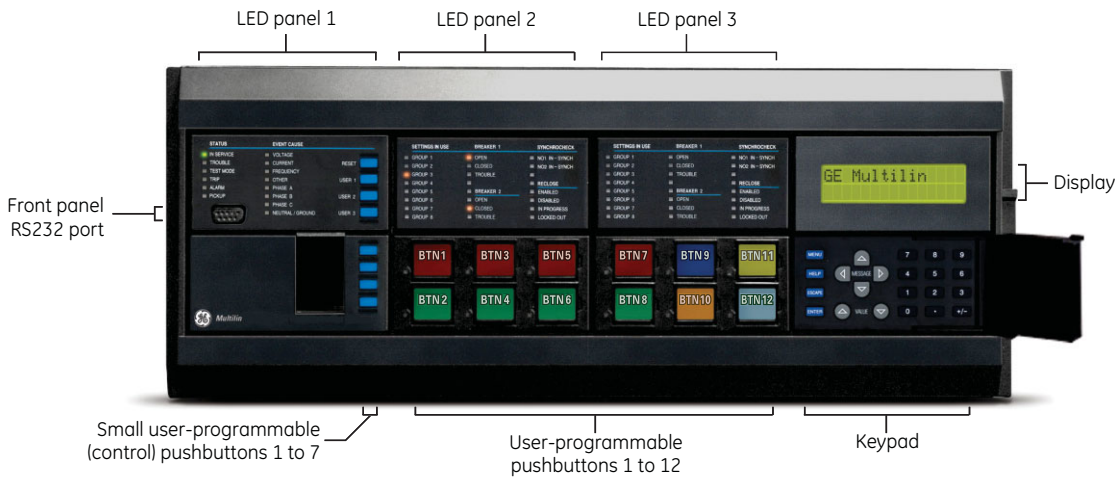


#### 4.2.1.2 Basic front panel

The basic front panel consists of LED panels, an RS232 port, keypad, LCD display, control pushbuttons, and optional user-programmable pushbuttons.

The front panel is hinged to allow easy access to removable modules inside the chassis. There is also a removable dust cover that is to be removed when accessing the keypad. The G30 basic front panel can be horizontal or vertical. The following figure shows the horizontal front panel.

Figure 4-18: Basic horizontal front panel

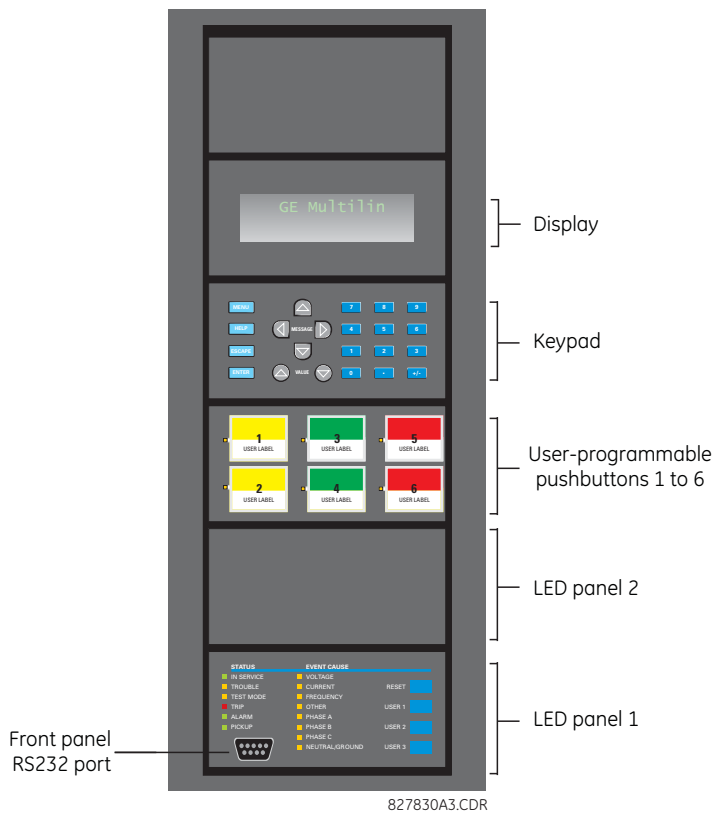


827801A9.CDR

4

The following figure shows the vertical front panel for relays ordered with the vertical option.

Figure 4-19: Basic vertical front panel

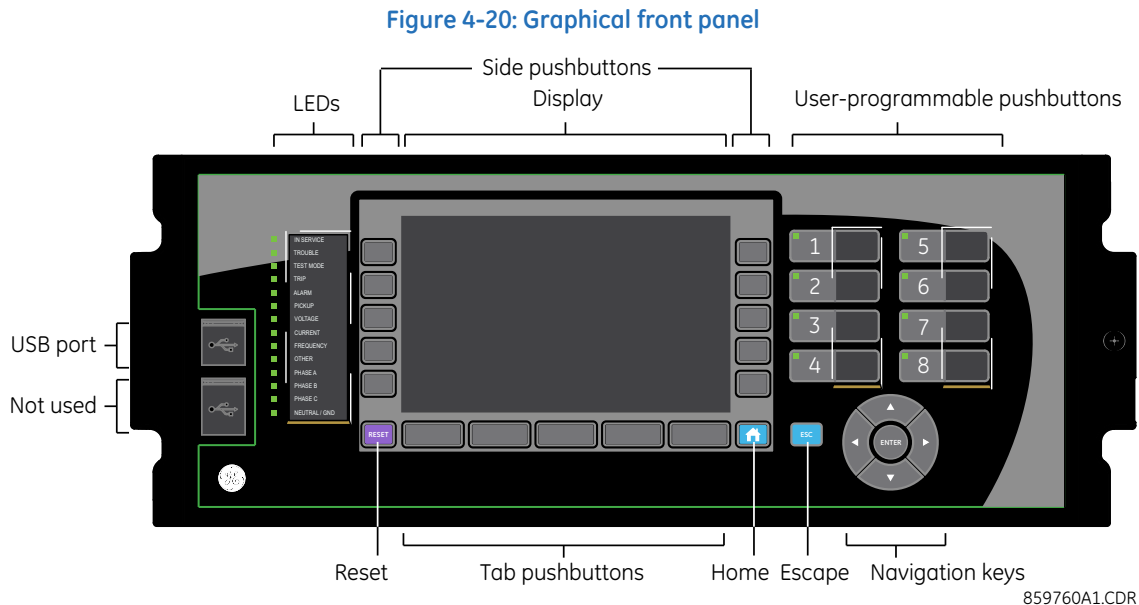


827830A3.CDR

### 4.2.1.3 Graphical front panel

The graphical front panel consists of a USB port, LED panel, color screen display, user-programmable pushbuttons, and navigation keys. The screen is used to read data, such as metering actual values, alarms, self-test messages, and event records, and for viewing single-line diagrams. Settings can be changed on the front panel, except for the graphical front panel itself and for IEC 61850. The USB port connects to a computer with the EnerVista software and can be used to upgrade the relay and to transfer files and settings. The USB port is the square type B.

User-programmable pushbuttons 9 to 16 can be programmed among the 10 pushbuttons on the left and right sides of the display.



## 4.2.2 Front panel display

### 4.2.2.1 Enhanced and basic front panels

Messages display on a backlit liquid crystal display (LCD) to make them visible under poor lighting conditions. When the keypad and display are not actively being used, the display defaults to user-defined messages. Any high-priority event-driven message overrides the default messages.

Up to 20 characters can be used to configure some setting names in the software, while up to 12 characters display on the front panel. A tilde ~ symbol is used for the twelfth character on the front panel when a name extends beyond the 12 character limit. An example is shown for a Virtual Input.

**Figure 4-21: Tilde symbols displays with names 12 or more characters long**

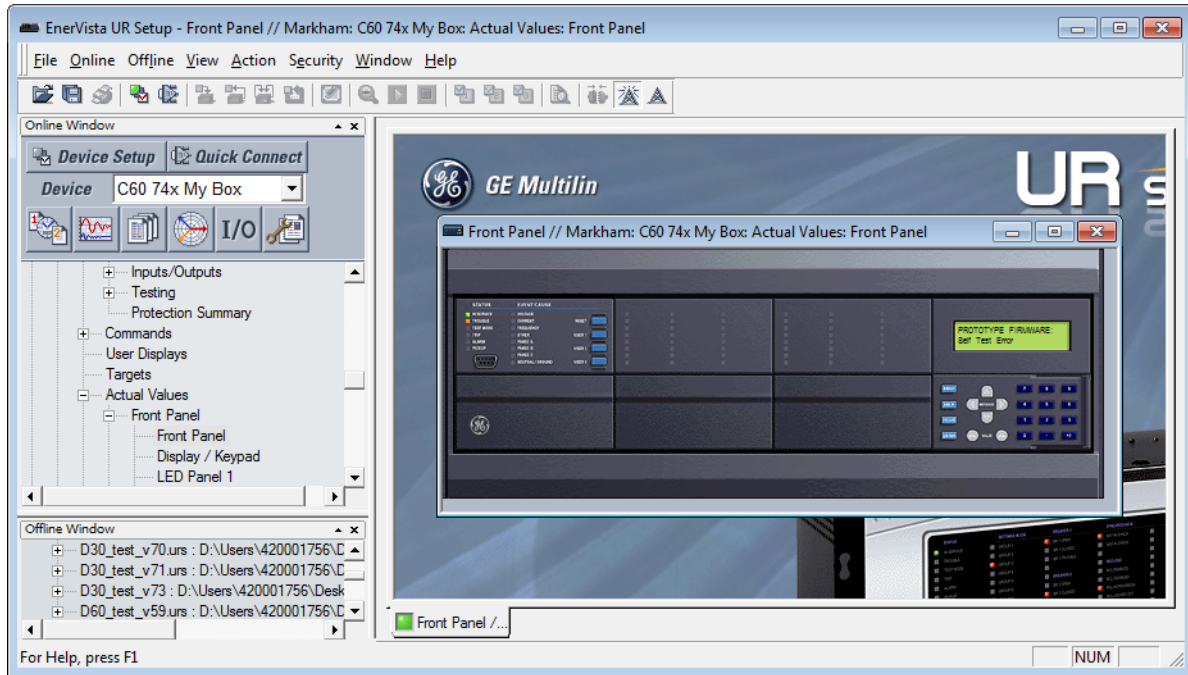


The front panel can be viewed and used in the EnerVista software, for example to view an error message displayed on the front panel or the LEDs.

To view the front panel in EnerVista software:

1. Click **Actual Values > Front Panel**, then any option.

Figure 4-22: Front panel use in the software (C60 shown)



4

#### 4.2.2.2 Graphical front panel

The graphical front panel has a seven-inch (17.8 cm) color liquid crystal display (LCD). The display provides convenient access to operational data generated by the relay, enables local control of power system devices, and allows display/editing of settings.

Header content varies by page. The home page displays any active icons, such as security status, active setting group, and active target messages. It shows the date and time of the relay. If the relay synchronizes to an external time source via PTP, IRIG-B, SNTP, and so on, the date/time is shown in white, and otherwise in yellow. On pages other than the home page, the header displays the name of the page.

The footer dynamically labels the Tab, or control, pushbuttons immediately below.

Page content displays between the header and footer.

Figure 4-23: Home page example with default content (product information)

Setting Group	Alarm	Target	Relay Date and Time
1			11-May-17 12:39:59
<b>Relay ID:</b>	Relay-1		<b>Remaining Connections</b>
<b>Last Setting Change:</b>	01-Jan-70 00:00:00		<b>MMS TCP:</b> 5
<b>Order Code:</b>	F60-U03-HEH-F8L-H6H		<b>Modbus TCP:</b> 4
<b>Relay Serial Number:</b>	MBEC159999#9		<b>DNP TCP:</b> 2
<b>Firmware Version:</b>	7.60		<b>IEC-104 TCP:</b> 0
<b>Modbus Slave Address:</b>	254		<b>SFTP:</b> 4
<b>Modbus TCP Port:</b>	502		
	<b>Port 1</b>	<b>Port 2</b>	<b>Port 3</b>
<b>IP Address:</b>	192.168.2.3	10.14.22.7	127.0.0.1
<b>Subnet Mask:</b>	255.255.255.0	255.255.255.0	255.0.0.0
<b>MAC Address:</b>	00A0F4000000	00A0F4000001	00A0F4000002
<b>Link Status:</b>	Fail	OK	Fail
SLDs	Annunciator	Metering	Event Record
Menu			

859850A1.cdr

4

There are multiple ways to navigate pages, by using the pushbuttons and the menu hierarchy. The menu hierarchy is similar to the other front panels whereby you select a submenu using Up and Down arrow pushbuttons, and press the **ENTER** or Right pushbutton. On setting pages, opening a setting for editing is done by highlighting the setting using Up and Down pushbuttons, and pressing the **ENTER** or Right pushbutton.

## Home page

Press the **Home** pushbutton to display the root page no matter the state. Any edit, control, or password entry sessions are cancelled. The header shows several relay/system status icons. The default content of the home page is the product information page and can be user-configured to show the content of any single-line diagram page, annunciator page, metering page, or event records page for example. The Tab pushbuttons on the bottom row each navigate to their page. The home page displays for a user-configured time period, then scrolls through user-configured pages, a feature referred to as rolling.

Holding the **Home** pushbutton for one second displays the product information page. The Home page also can display when settings are saved.



Security indicator, showing how many people are logged in, including local and remote users. The lock is red when one or more users are logged in and other otherwise green. When no users are logged in because login is not required, an icon does not display.



Identifies the active setting group number (not shown)



Displays when an abnormal annunciator alarm is present. Navigate to the Annunciator for details. When there are no such alarms, the icon does not display. Even when you acknowledge/reset an alarm, the icon displays as long as the condition remains. For example, a breaker trouble alarm displays, you acknowledge it, but the icon remains because the breaker trouble remains.



Active targets symbol, where targets are error messages. View error messages by pressing the **Menu** Tab pushbutton, then accessing the **TARGETS** menu. Pressing the **RESET** button clears those messages that can be.

Configure the home page in the software under **Settings > Product Setup > Graphical Panel > Home Page**. The menu does not display when there is no graphical front panel.



### Rolling mode

After a user-defined period of inactivity, the graphical front display rolls among up to 10 user-selected pages. The roll-to-pages are selected in the EnerVista software, with the defaults being the product information page. Each page displays for less than five seconds. Also, the display backlight intensity is lowered after a configurable period to a user-defined level (0, 10, 20, or 30%); lower intensity extends the life of the display.

Configure rolling mode in the software under **Settings > Product Setup > Graphical Panel > Rolling Mode**.

Operation works as follows:

- Press the **Home** pushbutton or **ESCAPE** pushbutton twice to cancel rolling, restore full backlight intensity, and return to the Home page
- Press the **ENTER**, **ESCAPE**, or a pushbutton to pause rolling once and restore full backlight intensity

Rolling is disabled by setting the delay to 0.

The following buttons display at the top of the window:

- **Save** — Updates the connected device if online or the open setting file if offline with changes made
- **Restore** — Undoes changes that have not been saved
- **Default** — Changes all rolling mode settings to their factory default values
- **Reset** — Displays factory default values. Previous changes are not lost unless you save the reset window.

4

### Single-line diagrams

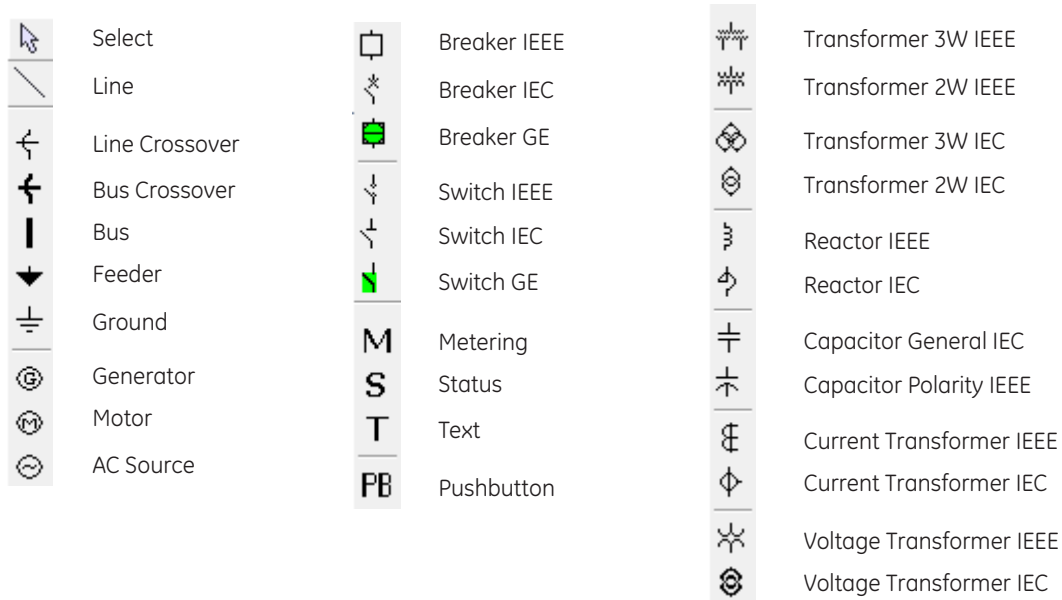
A single-line diagram, or mimic diagram, is a line drawing of elements in an electrical system. The graphical front panel displays up to five single-line diagrams. Each can be configured to show the arrangement of a portion of the power system, the status of circuit breakers and of ground and disconnect switches, user-programmable pushbuttons, and metering and status values. Each also enables control of the displayed power system devices.

One diagram is provided by default, single\_bus\_line\_dsc.mif, which can be modified.

Configure the diagrams under **Settings > Product Setup > Graphical Panel > Single Line Diagram Editor**.

Each single-line diagram page has a user-configurable name that appears in the header and in the footer Tab pushbutton label. Factory default names are SLD 1 to SLD 5. Pages that have no configured content have a blank Tab pushbutton label, and the Tab pushbutton does nothing. The label for the current page has a blue background.

Figure 4-24: Toolbar options for single-line diagram



859875A1.cdr



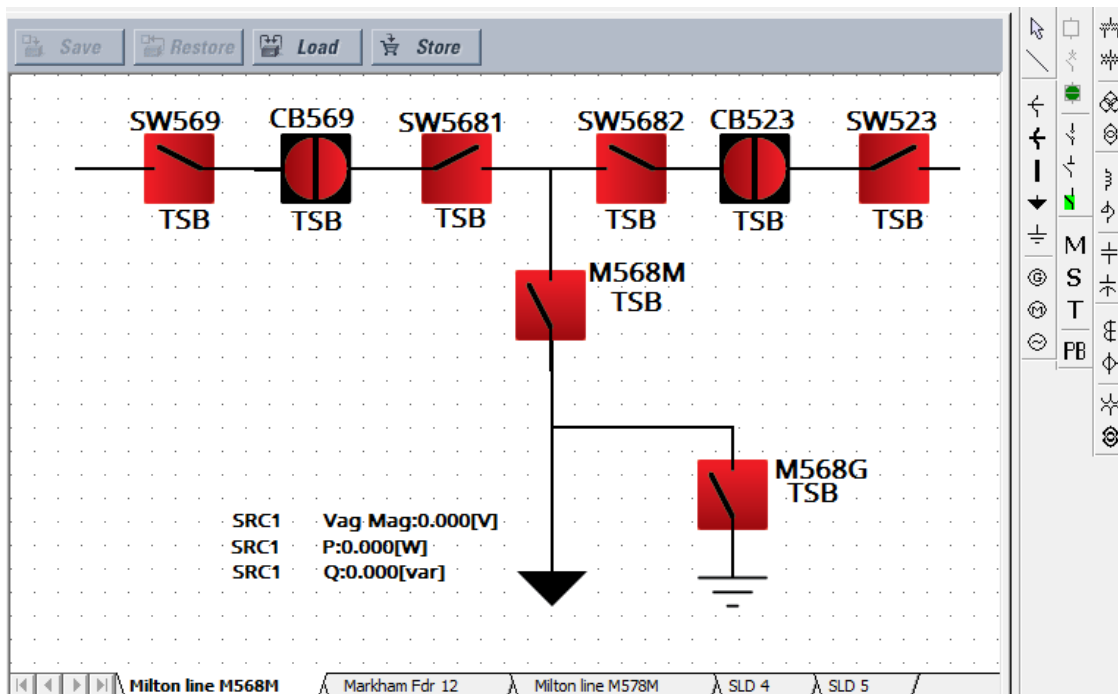
The letters T, S, B, R, and X next to a controllable element have the following meaning. An example (TSB) is shown in the next figure.

- T — The element is "tagged." Local and remote control of the device are inhibited, both open and close. Tripping is unaffected unless additional logic has been configured.
- S — The position indication of the device is substituted with a manually entered value
- B — Blocking open/close command is bypassed
- R — Autoreclose is enabled and not blocked
- X — The device is out-of-service and control is not available

### Single-line diagram example

The following example outlines how to create a circuit breaker diagram, then how to close the second circuit breaker. The figure shows six switches (SW, M), two breakers (CB), feeder (arrow), and ground (lined arrow).

Figure 4-25: Single-line diagram of open circuit breakers



Under **Settings > System Setup > Switches and Breakers**, enable and name the six switches and two breakers. Switch 6, M568G, has the A/3 Pole Opened setting on.

Figure 4-26: Configure Breaker and Switch settings

SETTING	PARAMETER
Switch 1 Function	Enabled
Switch 1 Name	SW569
Switch 1 Mode	3-Pole
Switch 1 Open	OFF
Switch 1 Block Open	OFF
Switch 1 Close	OFF
Switch 1 Block Close	OFF
Switch 1 Phase A/3 Pole Closed	ON
Switch 1 Phase A/3 Pole Opened	OFF
Switch 1 Phase B Closed	OFF

SETTING	PARAMETER
Switch 6 Function	Enabled
Switch 6 Name	M568G
Switch 6 Mode	3-Pole
Switch 6 Open	OFF
Switch 6 Block Open	OFF
Switch 6 Close	OFF
Switch 6 Block Close	OFF
Switch 6 Phase A/3 Pole Closed	OFF
Switch 6 Phase A/3 Pole Opened	ON
Switch 6 Phase B Closed	OFF
Switch 6 Phase B Opened	OFF

SETTING	PARAMETER
Breaker 1 Function	Enabled
Breaker 1 Push Button Control	Enabled
Breaker 1 Tagging	Enabled
Breaker 1 Substitution	Enabled
Breaker 1 Bypass	Enabled
Breaker 1 AR Block	Enabled
Breaker 1 Name	CB569
Breaker 1 Mode	3-Pole
Breaker 1 Open	OFF
Breaker 1 Block Open	OFF
Breaker 1 Close	OFF
Breaker 1 Block Close	OFF
Breaker 1 Phase A/3-Pole Closed	ON
Breaker 1 Phase A/3-Pole Opened	OFF
Breaker 1 Phase B Closed	OFF

4

In the EnerVista software, open the single-line diagram editor under **Settings > Product Setup > Graphical Panel > Single Line Diagram Editor**.

Add the four switches for the top line by clicking the GE switch symbol in the toolbar, then clicking in the window. (If the UR device is not online, the software attempts to connect.) Right-click to edit properties. Rotate switches SW569 and SW5682 to 270 degrees. Rotate switches 5681 and SW523 to 90 degrees. Ignore the TSB text.

Add the two lower switches. Leave rotation at 0 degrees.

Add the two breakers by clicking the GE breaker symbol in the toolbar, then click in the window. Right-click to edit properties, rotating 90 degrees and setting the color to red (open).

Draw lines to fill in the gaps between the switches and breakers by clicking the line symbol in the toolbar, then clicking and dragging on the canvas to draw a line. Do not draw a single line for the top line, but instead draw several small lines.

Add the feeder arrow head by clicking the symbol in the toolbar, then clicking the end of the line.

Add the ground symbol by clicking the symbol in the toolbar, then clicking the end of the line.

Add three metered values by clicking the M symbol in the toolbar, then clicking near the feeder arrow. Double-click to edit. The three metered values are SRC1 Vag Mag, SRC 1 P, and SRC 1 Q.

Name the page by right-clicking the bottom tab. Here, page 1 is renamed "Milton line M568M."

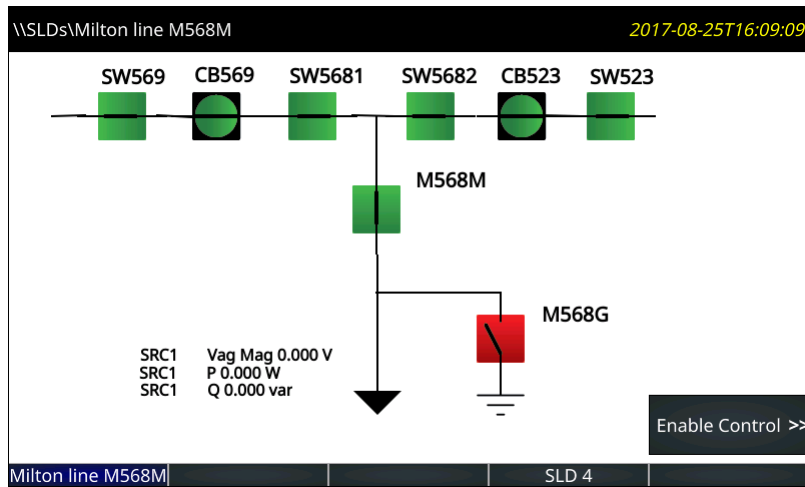
Note that active symbols in the toolbar display and those that are inactive are greyed-out.

The diagram has been created. Save it by clicking the **Save** button.

Next is to close circuit breaker CB523. This circuit breaker is shown at the top right of the figure. A vertical line means that it is open, and the color can be set as red or green.

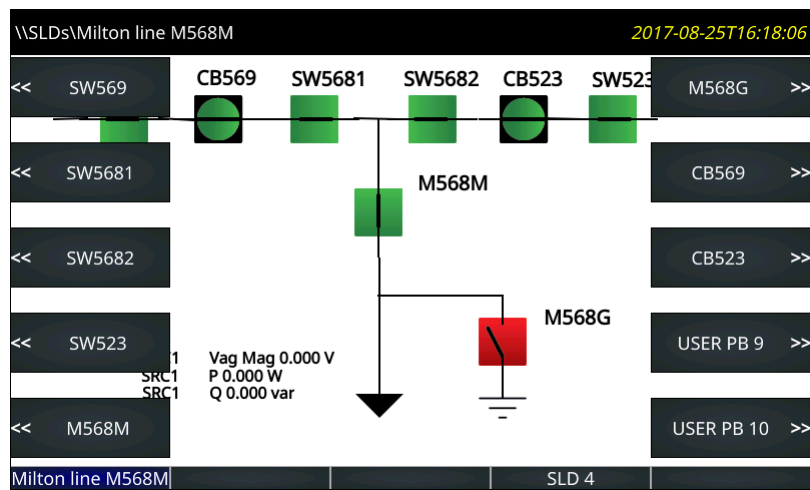
On the graphical front panel, press the **Home** pushbutton, then press the **SLDs** pushbutton to activate the first single-line diagram page.

Figure 4-27: Single-line diagram on graphical front panel



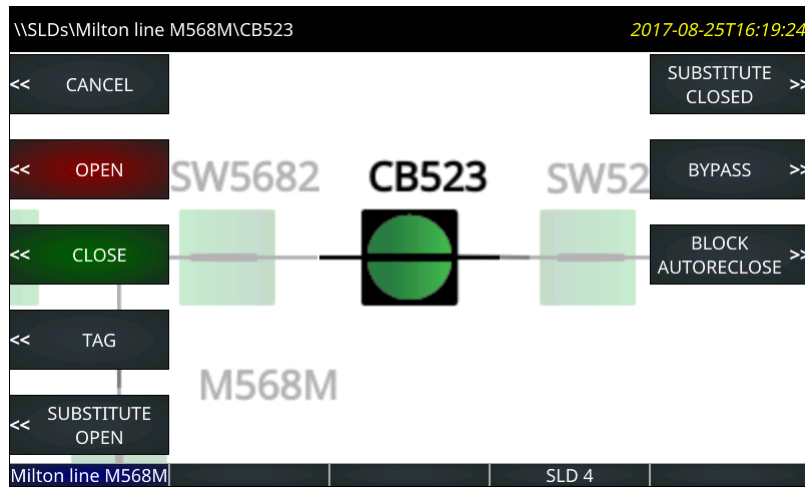
Press the **Enable Control** pushbutton. The side pushbutton labels display.

Figure 4-28: Side pushbutton display on graphical front panel



Press the **CB523** breaker pushbutton. Its menu displays.

Figure 4-29: Pushbuttons to control the breaker



4

Press the pushbutton to close the breaker, confirming the action at the prompt.

In this diagram, the two circuit breakers have hard-coded actions available to them. No action is possible on the switches. Note the USER PB 9 and 10 entries in the earlier figure. As outlined later, these are activated by clicking the PB icon on the software toolbar. These two pushbuttons can be configured under **Settings > Product Setup > User-Programmable Pushbuttons**.

### Single-line diagram editor use

Start the application in the EnerVista software under **Settings > Product Setup > Graphical Panel > Single Line Diagram Editor**.

The following buttons display at the top of the window:

- **Save** — Updates the connected device if online or the open setting file if offline with changes made
- **Restore** — Undoes changes that have not been saved
- **Load** — Opens single-line diagram files, which replaces one or all five windows with that in the file selected
- **Store** — Saves all five single-line diagrams as a .mif file. Because single-line diagrams are not retained when using the **Convert Device Settings** function, for example when converting in the Offline Window area from version 7.6 to 7.7, GE recommends making backup files using this function.

On the right side of the window is a toolbox containing the components that can be added to the window. These include line, breaker, disconnect, metering value, status value, text, and miscellaneous power system elements. To create the single-line diagram, click the symbol, then click in the window. Once in the window, the component can be positioned and its properties modified. When using the pointing device to position a component, the component can snap to the nearest snap point. Snap points are in a 4 x 4 rectangular grid. The keyboard arrow keys move the selected component(s) in one pixel increments when snap locations are inadequate. Multiple components can be selected and moved or deleted as a group, or copied and pasted to another location. Right- or double-clicking a component opens the properties window.

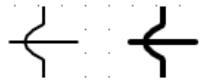
**Ctrl+A** selects all objects in a diagram.

### Lines

Line components represent power system buses or electrical connections between power system elements. They can also be used as visual dividers and underline.

To add a line component, click it in the toolbox, then click in the window. Double-click a line to open its properties window to set orientation.

Figure 4-30: Line and bus crossover symbols



### Static symbols

Static symbols depicting power system elements are available. For information, see the ANSI/IEEE 315A and IEC 60617 standards.

Up to 32 static symbols can be used per single-line diagram.

To add a symbol, click it in the toolbox, then click in the window. Double-click the symbol to open its properties window to set orientation.

Figure 4-31: IEEE and IEC static symbols

Device	Symbols
3W Transformer	
2W Transformer	
Rotating machines	
Reactor	
Ground	
Connector, Bus, Feeder, Crossover	
CT	
VT / PT	
Capacitor	

### Breaker and disconnect components

Breaker components and disconnect components are interfaces to the UR breaker control elements and disconnect switch elements. On a UR device they show dynamically the breaker or disconnect status as calculated by the element, and provide means to open, close, tag, bypass interlock, and substitute (force status of) the element. Breaker components in addition provide means to enable/disable breaker autoreclose.

Each breaker and disconnect component can be configured to use UR-style symbols, IEC symbols, or simple square/slash symbols as shown in the following figure. The symbols assume horizontal symbol orientation, red - closed color, and green - open scheme. With vertical orientation, they are rotated 90 degrees.

Figure 4-32: Single-line diagram symbols

	IEEE style (IEEE 315)	IEC Style (IEC 60617)	GE Style
Disconnect Switch (Open)			(1)
Disconnect Switch (Intermediate)			
Disconnect Switch (Closed)			(1)
Disconnect Switch (Bad Status/Disabled)			
Breaker (Open)			(1)
Breaker (Closed)			(1)
Breaker (Bad Status/Disabled)			
Breaker racked-out (Open)			(1)
Breaker racked-out (Closed)			(1)
Breaker racked-out (Bad Status)			
Breaker racked-in (Open)			(1)
Breaker racked-in (Closed)			(1)
Breaker racked-in (Bad Status)			

(1) Red/Green color scheme for closed/open is configurable by the user.

(2) 3-position disconnect switches can be represented by grouping two 2-position disconnects switches.

To add a breaker or disconnect component, click it in the toolbox, then click in the window. Up to 10 dynamic components can be added to each single-line diagram.

Breaker and disconnect components have three different parts: label, symbol, and flags. Drag each of its parts to their final locations. Double or right-click any of these parts to open the properties window. Properties that can be edited are label text, breaker control element or disconnect switch element number, symbol orientation (horizontal or vertical), color scheme (red - closed, or red - open), and assigned side button (if any). If the selected breaker or disconnect element does

not exist in the target relay or has not been enabled, then the component is displayed in the graphical front panel and in the drawing edit window in grey. The color scheme selection has no effect when an IEC style symbol is used because IEC style symbols do not use color.

**Symbol orientation**

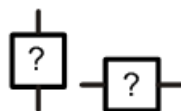
The figure shows the orientation available for the breaker and disconnect switch (taking Open status as examples). The default position is 0 degrees.

Figure 4-33: Single-line diagram symbol orientation

		0 degree	90 degrees	180 degrees	270 degrees
IEEE Style	Disconnect Switch (Open)				
	Breaker (Open)				
IEC Style	Disconnect Switch (Open)				
	Breaker (Open)				
GE Style	Disconnect Switch (Open)				
	Breaker (Open)				

A question mark displays in a symbol on the graphical front panel when status is bad. The question mark does not rotate with orientation.

Figure 4-34: Symbols when status is bad



The following figures show the orientation available for the static components. The default position is 0 degrees.

Figure 4-35: Single-line diagram static symbol orientation (sheet 1 of 2)

	0 degree	90 degrees	180 degrees	270 degrees
<b>3W Transformer</b>				
<b>2W Transformer</b>			0 degree	90 degrees
<b>3W Transformer</b>				
<b>2W Transformer</b>			0 degree	90 degrees
<b>Rotating machines</b>		0 degree	0 degree	0 degree
<b>Reactor</b>			0 degree	90 degrees
<b>Reactor</b>				
<b>Capacitor</b>				
<b>Capacitor</b>			0 degree	90 degrees

4



Figure 4-36: Single-line diagram static symbol orientation (sheet 2 of 2)

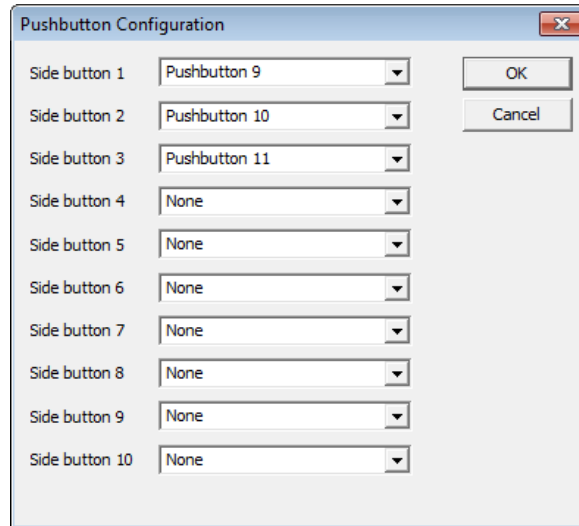
	0 degree	90 degrees	180 degrees	270 degrees
Ground				
Connector			0 degree	90 degrees
Bus			0 degree	90 degrees
Feeder				
Crossover			0 degree	90 degrees
CT				
CT				
VT / PT			0 degree	90 degrees
VT / PT			0 degree	90 degrees

### User-programmable pushbuttons

User-programmable pushbuttons 1 to 8 are physical pushbuttons on the right side of the graphical front panel, numbering down the two columns.

User-programmable pushbuttons 9 to 16 can be programmed among the 10 pushbuttons on the left and right sides of the screen display. They show dynamically and provide a means to perform the same control as the other pushbuttons.

Figure 4-37: Assigning pushbuttons 9 to 16 to the display



## 4

As an example, if you set up a single-line diagram with two breakers and six switches, then eight of the side pushbuttons are used automatically for control of the breakers and switches. Side pushbuttons 9 and 10 are available. In the single-line diagram, let us set side pushbutton 9 to clear event records as follows:

- Show side pushbutton 9 on the graphical front panel — Click the PB symbol in the toolbar, then set **Side button 9** to pushbutton 9 in the drop-down list. This pushbutton then displays when appropriate on the right side of the screen display.
- Program event record clearing — Set **Settings > Product Setup > Clear Relay Records > Clear Event Records** to FlexLogic operand [PUSHBUTTON 9 ON](#)
- Program pushbutton 9 — Set **Settings > Product Setup > User-Programmable Pushbuttons > Pushbutton 9 Function** to "Self-reset." When pressed, pushbutton 9 clears the event records.

To instead set the second user pushbutton (not a side pushbutton) to clear events, follow the second and third bullet points, selecting settings of [PUSHBUTTON 2 ON](#) and Pushbutton 2.

### Metering components

Metering components show dynamically the value of a FlexAnalog operand or actual value. Up to 16 metering components can be added to each single-line diagram.

To add a metering component, click the M symbol in the toolbox, then click in the window. Drag it to its final location. Double-click it to open the properties window. The figure shows the properties that can be edited.

Figure 4-38: Metering properties

### Status components

Status components show dynamically the value of a FlexLogic operand. Up to 16 can be used in a diagram and 30 in all single-line diagrams.

An example is to show the Off or On state of the **ANY MAJOR ERROR** FlexLogic operand. The name of the operand displays in the single-line diagram editor, then as Off or On on the graphical front panel.

To add a status component, click the S symbol in the toolbox, then click in the window. Drag it to its final location. Double-click it to open the properties window. Properties that can be edited include parameter (any FlexLogic operand), text color background color, and on and off text.

Optionally add a text label to display beside the status.

### Text

Text components show a single line of user-configured text.

Up to 16 text components can be used per single-line diagram.

To add a text component, click the T symbol in the toolbox, then click in the window. Drag it to its final location. Double-click it to open the properties window. Properties that can be edited are text, color, and size.

### Annunciator

An annunciator is a grid of small windows for alarms, actual values, self-test messages, and product information.

The graphical front panel emulates a conventional annunciator panel. The annunciator has 96 windows, each with a description of the alarm condition that lights the window. The windows are arranged in rows and columns of 3 x 4, 4 x 6, or 6 x 8 over several pages. Each window can have up to three lines of configurable text, and one line can instead be a metered value. Normally the window background is dark, and when the configured FlexLogic operand becomes On, the window lights up.

The figure shows that two alarms are active. One alarm is configured red and the other alarm is configured blue. The red alarm type is Self Reset, so the alarm displays in a solid color. The blue alarm type is Acknowledgeable, so the alarm flashes until it is acknowledged, for example by navigating with the arrow keys and pressing the **ENTER** button. The alarm then remains blue until the trigger condition is eliminated.

Figure 4-39: 3x4 annunciator page with two active windows

\\Annunciator\Fdr 12 Alarms			23-Jun-17 12:35:08 PM	
Breaker 1 Failure	Breaker 2 Failure	Autoreclos Lockout	Fuse Failure	
Setting Group 2 Active	Breaker 1 Arc Phs A 0.000 kA2-cyc	Breaker 1 Arc Phs B 0.000 kA2-cyc	Breaker 1 Arc Phs C 0.000 kA2-cyc	
Fault Report	Breaker 1 Flashover	Breaker 2 Flashover		
M568M Alarms	Fdr 12 Alarms	Station Alarms	Misc Alarms	Next

4

To display the annunciator, press the **Home** pushbutton, then the **Annunciator** Tab pushbutton. If there is one or more window in alarm or requiring reset, the annunciator page showing the first of these opens. Otherwise the first annunciator page opens.

Alarms do not display automatically. Set the Home page and/or rolling pages to display annunciator pages.

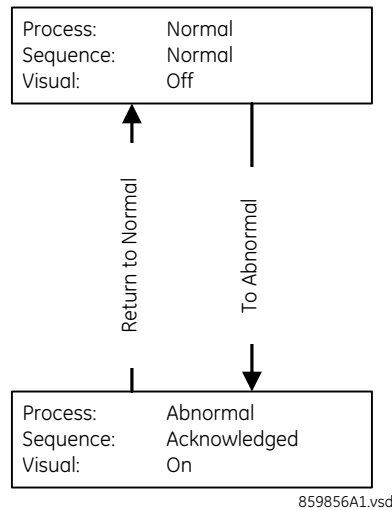
The Tab pushbutton labels populate with the annunciator pages. The label text for each annunciator page is configurable and displays in the header and Tab label. The current page has a blue Tab label. Tab labels for annunciator pages that have an active window (that is, on, latched, or unacknowledged) are red. Pages where alarms are not triggered have a grey Tab label. Pages that have no configured windows do not have Tab pushbuttons and do not display.

The Up, Down, Left, and Right pushbuttons cause the selection to move one window in the indicated direction. Pressing the Right pushbutton past the last window in a row scrolls the display to any next annunciator page, not the next row. The behavior is similar for the other pushbuttons, for example pressing the Up pushbutton while in the top row goes to any previous page. If no previous page exists, no action occurs.

Annunciator windows are positioned statically, so that all windows are visible no matter their state.

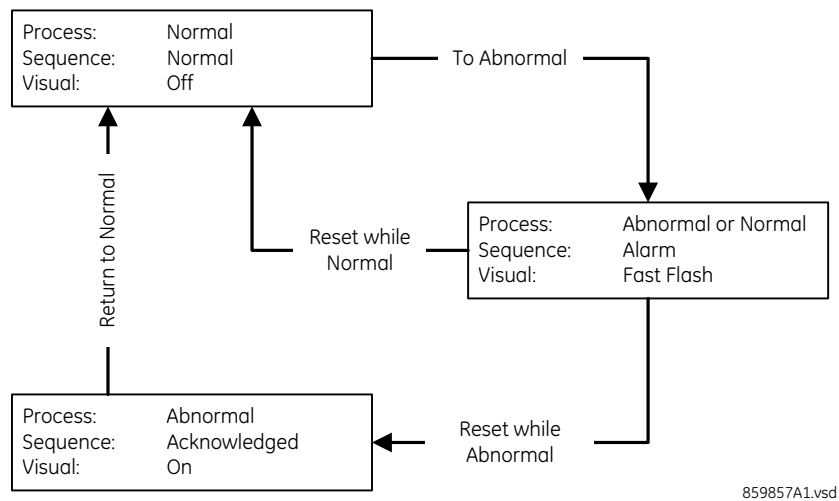
Alarm types of each window can be configured as Self Reset, Latched, or Acknowledgeable. In Self Reset mode, the window lighting follows the state of the configured FlexLogic operand. The self-reset mode alarm sequence conforms to ISA-18.1-1979 (R2004) standard type A 4 5 6.

Figure 4-40: Annunciator alarm sequence in Self Reset mode



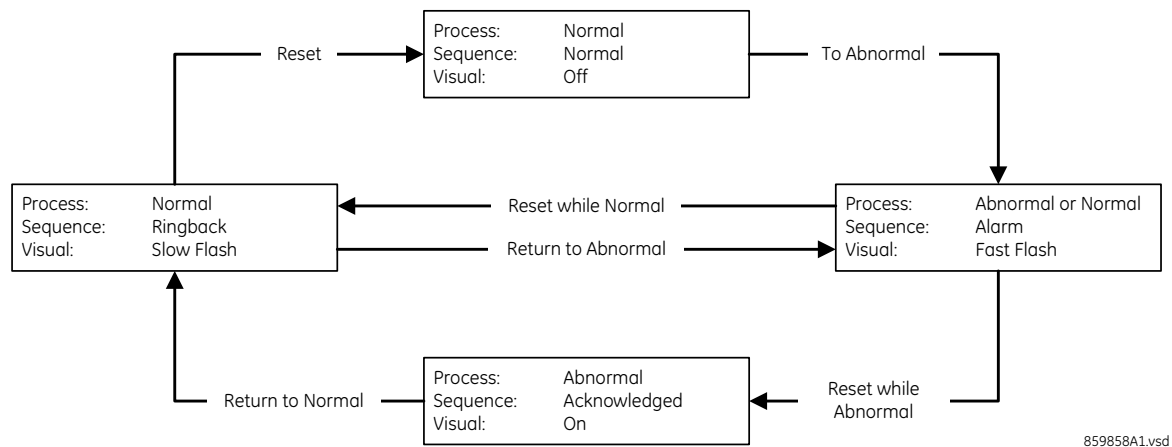
Latched mode is intended for transient signals such as trip, and it conforms to ISA-18.1-1979 (R2004) standard type M 6.

**Figure 4-41: Annunciator alarm sequence in Latched mode**



In Acknowledgeable mode, both Off to On and On to Off state changes in the configured operand cause the background to flash; the window must be acknowledged/reset to cancel flashing. This mode conforms to ISA-18.1-1979 (R2004) standard type R-6.

**Figure 4-42: Annunciator alarm sequence in Acknowledgeable mode**



To reset all annunciator windows:

1. In the software, access **Actual Values > Graphical Panel > Annunciator Panel**.

To acknowledge/reset all annunciator windows on a page:

1. On the graphical front panel with none of the annunciator windows selected, press the **RESET** pushbutton once for acknowledgement and twice for reset. The flashing stops.

To acknowledge an annunciator window:

1. On the graphical front panel, press the Up, Down, Left, and Right pushbuttons to select the window, so that it has a yellow outline. Press the **RESET** or **ENTER** pushbutton. While a window is selected, if that window has activated since the last restart, the date/time of the last activation of that window displays in the header.

An alarm remains in an alarm state (for example, displays red) when the condition remains. That is, if you acknowledged a flashing alarm but the alarm condition remains, the background color remains red.

The **SETTINGS > INPUTS/OUTPUTS > RESETTING > RESET ANNUNCIATOR** setting can be used to select a FlexLogic operand that when activated acknowledges/resets all annunciator windows.

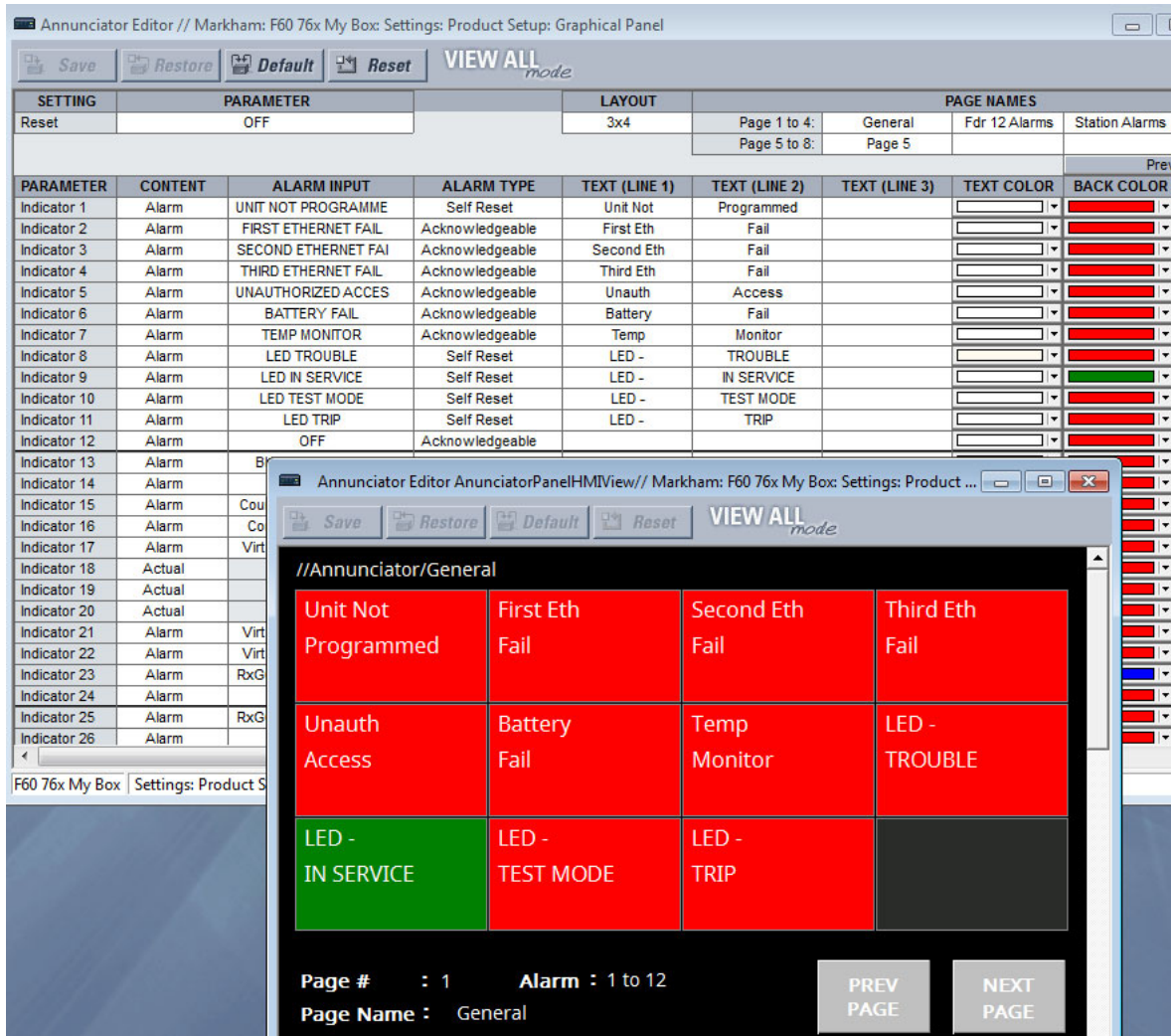
### Annunciator editor

The annunciator editor is used to configure alarms and actual value displays for the graphical front panel.

The path in the EnerVista software is **Settings > Product Setup > Graphical Panel > Annunciator Editor**.

The figure shows the annunciator editor and its preview window. The page name is entered as General at the top right. Acknowledgeable and self-resetting alarms are set for basic functions, such as online/offline, Ethernet ports, unauthorized access/failed logins, and battery failure. The text to display in the annunciator window is entered. The IN SERVICE LED is set to be green because when the device is on, this LED is green. The preview shows what the annunciator looks like with all alarms triggered. The last window is not configured and displays blank/grey. In order for the Ethernet and battery alarms to work, the corresponding self-test alarms have been enabled under **Settings > Product Setup > User-Programmable Self Tests** (not shown). The LEDs can be viewed on the front panel, so adding them to the annunciator is for illustrative purposes only.

Figure 4-43: Annunciator editor and preview window



The three page layouts (3 × 4, 4 × 6, and 6 × 8) select the number of rows × columns of windows that appear in a page. Annunciator window size and text size shrink as the number of annunciator windows in a page increases.

Properties that can be edited include alarm type (acknowledgeable, latched, self-reset), alarm input (any FlexLogic operand), text color, and alarm background color.

The following buttons display at the top of the window:

- **Save** — Updates the connected device if online or the open setting file if offline with changes made
- **Restore** — Undoes changes that have not been saved
- **Default** — Changes all annunciator settings to their factory default values
- **Reset** — Displays factory default values. Previous settings are not lost unless you save the reset window.

## Metering editor

The metering editor is an actual values display tool. It creates pages of actual values for the graphical front panel. There are two types: tables and phasor diagrams. Tabular actual values pages have settings to configure, while phasor actual values pages have no settings. Five tabular metering pages can be configured, while there can be a phasor page for each configured AC source. They display on the graphical front panel using the **Metering** Tab pushbutton.

The path to the editor is **Settings > Product Setup > Graphical Panel > Metering Editor**.

Figure 4-44: Metering editor with preview window

The screenshot displays the Metering Editor interface. The main window has a toolbar with buttons for Save, Restore, Default, and Reset, along with a 'VIEW ALL mode' button. Below the toolbar is a table with columns for STATUS, STATUS INPUTS, CURRENT PAGE, and a Preview section. The Preview section contains a table with columns for PARAMETER, CONTENT, STATUS INDEX, TEXT, OFF TEXT, FONT, TEXT COLOR, BACK COLOR, and ACTUAL. A preview window is open, showing a table of actual values for various components like Bus Tie, Station Total, and Feeder 1 through 6.

PARAMETER	CONTENT	STATUS INDEX	TEXT	OFF TEXT	FONT	TEXT COLOR	BACK COLOR	ACTUAL
Cell(5, 2)	Text	Not Configured			16			Configure
Cell(5, 3)	Text	Not Configured			16			Configure
Cell(5, 4)	Text	Not Configured			16			Configure
Cell(6, 1)	Text	Not Configured	Bus 1		16			Configure
Cell(6, 2)	Actual	Not Configured			16			Configure
Cell(6, 3)	Text	Not Configured	Bus 2		16			Configure
Cell(6, 4)	Actual	Not Configured			16			Configure
Cell(7, 1)	Text	Not Configured	Feeder 1		16			Configure
Cell(7, 2)	Actual	Not Configured			16			Configure
Cell(7, 3)	Text	Not Configured	Feeder 2		16			Configure
Cell(7, 4)	Actual	Not Configured			16			Configure
Cell(8, 1)	Text	Not Configured	Feeder 3		16			Configure
Cell(8, 2)	Actual	Not Configured			16			Configure
Cell(8, 3)	Text	Not Configured	Feeder 4		16			Configure
Cell(8, 4)	Actual	Not Configured			16			Configure
Cell(9, 1)	Text	Not Configured	Feeder 5		16			Configure
Cell(9, 2)	Actual	Not Configured			16			Configure
Cell(9, 3)	Text	Not Configured	Feeder 6		16			Configure
Cell(9, 4)	Actual	Not Configured			16			Configure
Cell(10, 1)	Text	Not Configured			16			Configure
Cell(10, 2)	Text	Not Configured			16			Configure
Cell(10, 3)	Text	Not Configured			16			Configure
Cell(10, 4)	Text	Not Configured			16			Configure
Cell(11, 1)	Text	Not Configured			16			Configure
Cell(11, 2)	Text	Not Configured			16			Configure
Cell(11, 3)	Text	Not Configured			16			Configure
Cell(11, 4)	Text	Not Configured			16			Configure
Cell(12, 1)	Text	Not Configured			16			Configure
Cell(12, 2)	Text	Not Configured			16			Configure
Cell(12, 3)	Text	Not Configured			16			Configure
Cell(12, 4)	Text	Not Configured			16			Configure

The preview window shows a table with the following data:

Component	Value	Component	Value
Bus Tie is Open			
Station Total	0.000		0.000
Bus 1	0.000	Bus 2	0.000
Feeder 1	0.000	Feeder 2	0.000
Feeder 3	0.000	Feeder 4	0.000
Feeder 5	0.000	Feeder 6	0.000

Page 1 : Page 1 Rows: 12 Columns:

The inputs are selected at the top. Select from the drop-down list or start typing in the field.

The page, page name, and grid layout are set below the inputs.

Content to display is configured with the cell lines. The content can be actual values, a status indicator, or text.



- Actual value — Select from the FlexAnalog applicable to the G30, where a FlexAnalog is an analog parameter
- Status — Select from the FlexLogic operands identified in the Status Inputs at the top of the window. An example is to display text to indicate whether the BATTERY FAIL operand is on or off.
- Text — Enter text to display in the table, for example name of table or column heading

If the metering input is other than OFF, the value of the selected metering input displays, formatted according to the size, text color, units, multiplier, and decimal configuration. Otherwise either the Text or the Off Text displays depending on the value of the operand selected by setting Status Input/Index.

A maximum of eight Status Inputs/Indexes can be used per metering page and 16 in all metering pages.

The following buttons display at the top of the window:

- **Save** — Updates the connected device if online or the open setting file if offline with changes made
- **Restore** — Undoes changes that have not been saved
- **Default** — Changes all actual value settings to their factory default values
- **Reset** — Displays factory default values. Previous settings are not lost unless you save the reset window.

### Configurable navigation editor

Configurable Navigation is a feature that opens specified pages when specific FlexLogic operands are activated. This feature is useful to open the annunciator page containing an annunciator window that has entered its abnormal state.

In the example shown, failure of any of the three Ethernet ports triggers the Product Information page to display. With unauthorized access (such as wrong password), IRIG-B clock failure, or breaker trouble, the Event Records display. When a breaker opens, a single-line diagram displays. For the Ethernet and IRIG-B failure pages to work, these functions also have been enabled under **Settings > Product Setup > User-Programmable Self Tests**. For the breaker trouble, the single-line diagram has been configured.

Figure 4-45: Navigation editor

The screenshot shows a window titled 'Configurable Navigation // Markham: F60 76x My Box: Settings: Product Setup: Graphical Panel'. At the top, there are buttons for 'Save', 'Restore', 'Default', and 'Reset', along with a 'VIEW ALL mode' button. Below these is a table with three columns: 'SETTING', 'CONDITION', and 'ACTIVATE PAGE'. The table contains 12 rows of data. At the bottom of the window, there is a status bar with 'F60 76x My Box', 'Settings: Product Setup: Graphical Panel', and 'Screen ID: 249'.

SETTING	CONDITION	ACTIVATE PAGE
Configurable Navigation Condition 1	FIRST ETHERNET FAIL	Product Information
Configurable Navigation Condition 2	SECOND ETHERNET FAIL	Product Information
Configurable Navigation Condition 3	THIRD ETHERNET FAIL	Product Information
Configurable Navigation Condition 4	UNAUTHORIZED ACCESS	Event Records
Configurable Navigation Condition 5	IRIG-b FAILURE	Event Records
Configurable Navigation Condition 6	BREAKER 1 TROUBLE	Event Records
Configurable Navigation Condition 7	BREAKER 2 TROUBLE	Event Records
Configurable Navigation Condition 8	BREAKER 1 OPEN	SLD 1
Configurable Navigation Condition 9	BREAKER 2 OPEN	SLD 1
Configurable Navigation Condition 10	OFF	Product Information
Configurable Navigation Condition 11	OFF	Product Information
Configurable Navigation Condition 12	OFF	Product Information

The path is **Settings > Product Setup > Graphical Panel > Configurable Navigation**.

The settings consist of 64 field pairs, each with a condition and an activation page. The condition selects any FlexLogic operand. The activation page selection is the standard set, such as product information, event records, annunciator pages, and single-line diagrams.

To use the feature, select a **CONDITION**, select its **ACTIVATE PAGE** option, then save. When selecting the condition operand, open the drop-down list and start typing in the field to auto-fill. For example, typing F displays FIRST ETHERNET FAIL.

The following buttons display at the top of the window:

- **Save** — Updates the connected device if online or the open setting file if offline with changes made
- **Restore** — Undoes changes that have not been saved



- **Default** — Changes all settings in the window to factory default values
- **Reset** — Displays factory default values. Previous settings are not lost unless you save the reset window.

## 4.2.3 Front panel navigation keys

### 4.2.3.1 Enhanced and basic front panels

Display messages are organized into pages under the following headings: actual values, settings, commands, and targets. The **MENU** key navigates through these pages. Each heading page is divided further into further submenus.

The **MESSAGE** keys navigate through the submenus. The **VALUE** keys increment or decrement numerical setting values when in programming mode. These keys also scroll through alphanumeric values in the text edit mode. Alternatively, values can be entered with the numeric keypad.

The decimal key initiates and advances to the next character in text edit mode or enters a decimal point.

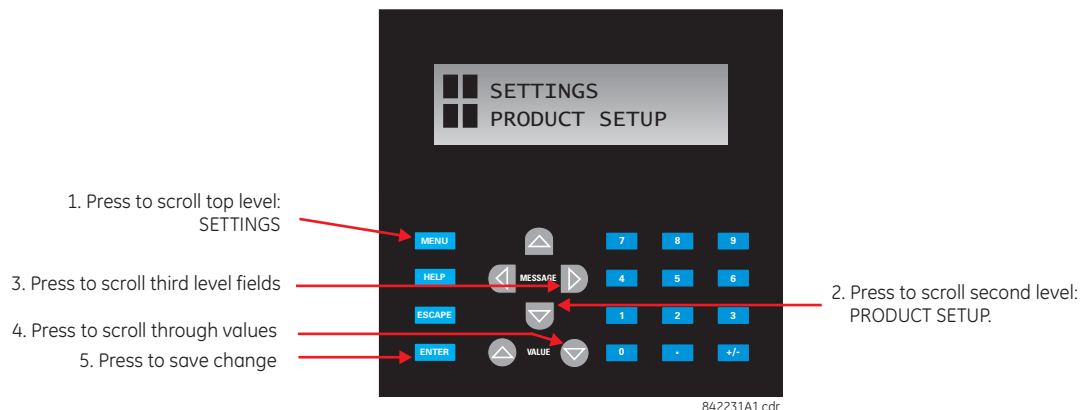
The **HELP** key can be pressed at any time for context-sensitive help messages.

The **ENTER** key stores setting values.

When entering an IP address on the front panel, key in the first sequence of the number, then press the **•** key for the decimal place. For example, for 127.0.0.1, press 127, then **•**, then 0, then **•**, then 0, then **•**, then 0, then **•**, then 1. To save the address, press the **ENTER** key.

The figure shows the sequence to use to enter a setting. Subsequent sections provide more detail.

**Figure 4-46: Front panel keypad use (basic front panel shown)**



### 4.2.3.2 Graphical front panel

These keys and pushbuttons navigate and select items.



**Up/Down/Left/Right** — These pushbuttons move the selector among the options on a page. The selection is indicated by a yellow background or a yellow border. On menu pages, the Right pushbutton activates the selected submenu drilling down the menu hierarchy, and the Left pushbutton backs up the menu hierarchy. These pushbuttons have a typematic feature on some pages: after a short pause, the pushbutton repeats as long as it is pressed.



**ENTER** — Activates the selection on the display, for example a submenu, a control, a keypad key, or a setting. Also stores updated settings.



**ESCAPE** — If a setting is open for edit, this pushbutton closes the setting without saving. If a popup menu is open, this pushbutton closes it. If an item is selected, this pushbutton deselects it. Otherwise this pushbutton activates the previous page in the page hierarchy.



**RESET** — Clears all latched LED indications and target messages. When a page with acknowledgeable/resettable items is displayed, it instead resets/acknowledges all items on that page, or if an item on that page is selected, it resets/acknowledges that item. If you reset/acknowledge alarms, they stop flashing but remain in the alarm state as long as that state remains. In other words, a red alarm does not switch off just because you acknowledged the alarm.



**Home** — Activates the home page, which is the root page. The page displays product information by default and is configurable.



**Side pushbutton** — Five pushbuttons on the left side of the display and five pushbuttons on the right side of the display. They perform various functions depending on the displayed page, such as switchgear controls. The display dynamically shows its label next to each side pushbutton when the pushbutton has an assigned function. These pushbuttons can also be programmed to function as user-programmable pushbuttons 9 to 16.



**Tab pushbutton** — Five pushbuttons under the display. They navigate through the page hierarchy, and on some pages activate other actions. The display footer dynamically labels the page or action that is activated by the Tab pushbutton.



**User-programmable pushbutton** — Eight physical pushbuttons are associated with the first eight user-programmable pushbutton elements. Numbering is down, that is, 1 to 4 down the left column and 5 to 8 down the right column. These elements control a set of FlexLogic operands that can be used to initiate outputs or select modes. Each physical pushbutton has an integrated LED indicator that can be user-configured to display the appropriate status. These pushbuttons have clear covers behind which custom labels can be mounted. A utility is available to print the labels, under **File > Front Panel Report** in the software.

## 4.2.4 LED indicators

### 4.2.4.1 Enhanced front panel

The enhanced front panel display provides five columns of LED indicators. The first column contains 14 status and event-cause LEDs. The next four columns contain the 48 user-programmable LEDs.

The **RESET** key is used to reset any latched LED indicator or target message, once the condition has been cleared (these latched conditions can also be reset via the **SETTINGS** ⇒ **INPUT/OUTPUTS** ⇒ **RESETTING** menu).

The **USER** keys are used by the breaker control feature.

Figure 4-47: Typical LED panel for enhanced front pane



842811A1.CDR

The status indicators in the first column are as follows:

- **IN SERVICE** — Indicates that control power is applied, all monitored inputs/outputs and internal systems are fine, and the relay is in (online) Programmed mode (under **Settings > Product Setup > Installation**)

- **TROUBLE** — Indicates that the relay has detected an internal problem. Check the self-test messages outlined at the end of the Commands and Targets chapter, and view the event records under **Actual Values > Records**. For a beta / pre-release, this LED is always on.
- **TEST MODE** — Indicates that the relay is in test mode. For information, see the Test Mode section in the Settings chapter.
- **TRIP** — Indicates that the selected FlexLogic operand serving as a trip input has operated. Set the operand under **Settings > Product Setup > User-Programmable LEDs > Trip & Alarm LEDs**. This indicator latches; initiate the reset command to reset the latch.
- **ALARM** — Indicates that the FlexLogic operand serving as an alarm switch has operated. Set the operand under **Settings > Product Setup > User-Programmable LEDs > Trip & Alarm LEDs**. This indicator never latches.
- **PICKUP** — Indicates that an element is picked up. This indicator never latches.

The event-cause indicators in the first column are as follows.

Event-cause LEDs are below the status LEDs. They are turned on or off by protection elements that have their respective target setting selected as either “Enabled” or “Latched.” If a protection element target setting is “Enabled,” then the corresponding event-cause LEDs remain on as long as the operand associated with the element remains asserted. If a protection element target setting is “Latched,” then the corresponding event-cause LEDs turn on when the operate operand associated with the element is asserted and remains on until the **RESET** button on the front panel is pressed after the operand is reset.

All elements that are able to discriminate faulted phases can independently turn off or on the phase A, B, or C LEDs. This includes phase instantaneous overcurrent, phase undervoltage, and so on. This means that the phase A, B, and C operate operands for individual protection elements are ORed to turn on or off the phase A, B, or C LEDs.

- **VOLTAGE** — This LED indicates voltage was involved
- **CURRENT** — This LED indicates current was involved
- **FREQUENCY** — This LED indicates frequency was involved
- **OTHER** — This LED indicates a composite function was involved
- **PHASE A** — This LED indicates phase A was involved
- **PHASE B** — This LED indicates phase B was involved
- **PHASE C** — This LED indicates phase C was involved
- **NEUTRAL/GROUND** — This LED indicates that neutral or ground was involved

The user-programmable LEDs consist of 48 amber LED indicators in four columns. The operation of these LEDs is user-defined. Support for applying a customized label beside every LED is provided. Default labels are shipped in the label package of every G30, together with custom templates. The default labels can be replaced by user-printed labels.

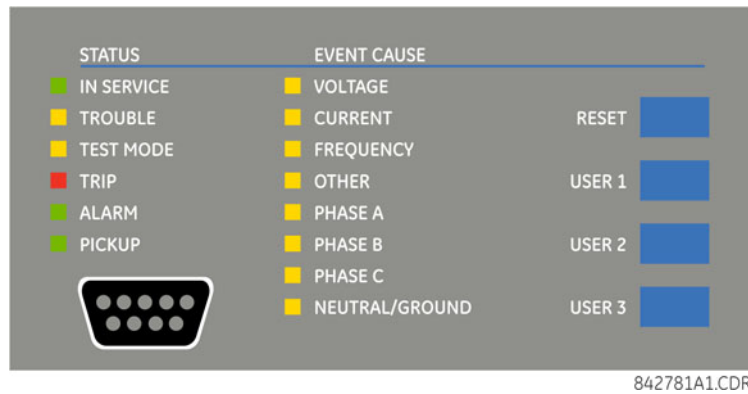
User customization of LED operation is of maximum benefit in installations where languages other than English are used to communicate with operators. See the User-Programmable LEDs section in chapter 5 for the settings used to program the operation of the LEDs on these panels.

#### 4.2.4.2 Basic front panel

The basic front panel consists of three panels with LED indicators, keys, and a communications port. The **RESET** key is used to reset any latched LED indicator or target message, once the condition has been cleared (these latched conditions can also be reset via the **SETTINGS** ⇒ **INPUT/OUTPUTS** ⇒ **RESETTING** menu). The RS232 port is for connection to a computer.

The **USER** keys are used by the breaker control feature.

Figure 4-48: LED panel 1



### Status indicators

- **IN SERVICE** — Indicates that control power is applied, all monitored inputs/outputs and internal systems are fine, and the relay is in (online) Programmed mode (under **Settings > Product Setup > Installation**)
- **TROUBLE** — Indicates that the relay has detected an internal problem. Check the self-test messages outlined at the end of the Commands and Targets chapter, and view the event records under **Actual Values > Records**. For a beta / pre-release, this LED is always on.
- **TEST MODE** — Indicates that the relay is in test mode. For information, see the Test Mode section in the Settings chapter.
- **TRIP** — Indicates that the selected FlexLogic operand serving as a trip switch has operated. This indicator always latches; initiate the reset command to reset the latch.
- **ALARM** — Indicates that the selected FlexLogic operand serving as an alarm switch has operated. This indicator never latches.
- **PICKUP** — Indicates that an element is picked up. This indicator never latches.

### Event-cause indicators

Event-cause LEDs are turned on or off by protection elements that have their respective target setting selected as either "Enabled" or "Latched." If a protection element target setting is "Enabled," then the corresponding event cause LEDs remain on as long as the operand associated with the element remains asserted. If a protection element target setting is "Latched," then the corresponding event cause LEDs turn on when the operate operand associated with the element is asserted and remains on until the **RESET** button on the front panel is pressed after the operand is reset.

All elements that are able to discriminate faulted phases can independently turn off or on the phase A, B, or C LEDs. This includes phase instantaneous overcurrent, phase undervoltage, and so on. This means that the phase A, B, and C operate operands for individual protection elements are ORed to turn on or off the phase A, B, or C LEDs.

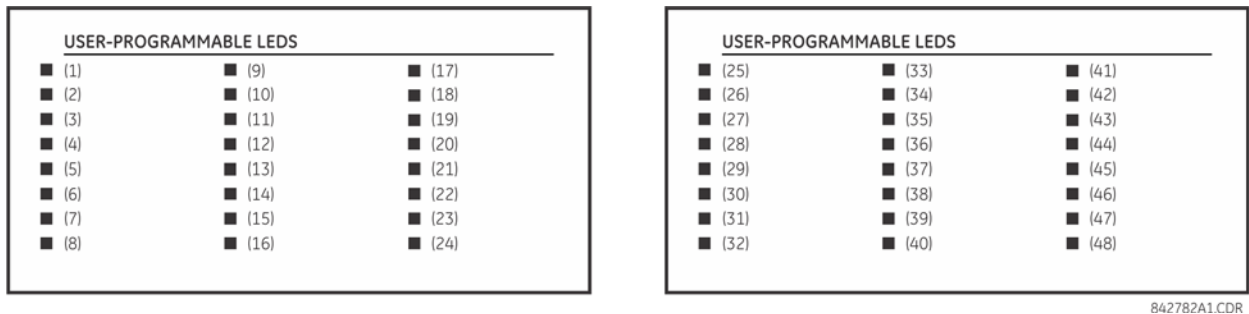
- **VOLTAGE** — Indicates voltage was involved
- **CURRENT** — Indicates current was involved
- **FREQUENCY** — Indicates frequency was involved
- **OTHER** — Indicates a composite function was involved
- **PHASE A** — Indicates phase A was involved
- **PHASE B** — Indicates phase B was involved
- **PHASE C** — Indicates phase C was involved
- **NEUTRAL/GROUND** — Indicates that neutral or ground was involved

### User-programmable indicators

The second and third panels provide 48 amber LED indicators whose operation is controlled by the user. Custom labelling can be done.

User customization of LED operation is of maximum benefit in installations where languages other than English are used to communicate with operators. See the User-programmable LEDs section in chapter 5 for the settings used to program the operation of the LEDs on these panels.

Figure 4-49: LED panels 2 and 3 (index template)



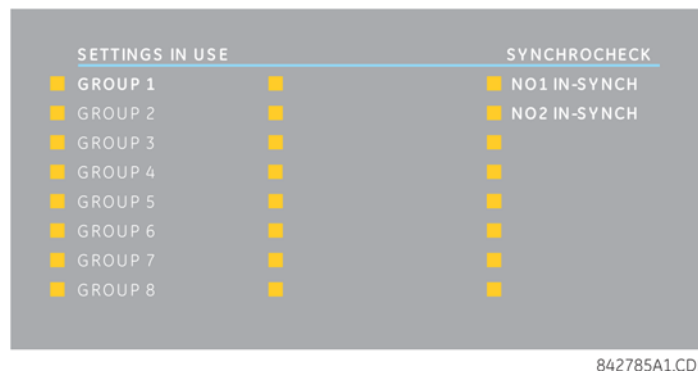
### Default labels for LED panel 2

The default labels are intended to represent the following:

- **GROUP 1...6** — The illuminated GROUP is the active settings group
- **SYNCHROCHECK NO1(4) IN-SYNCH** — Voltages have satisfied the synchrocheck element

The relay is shipped with the default label for the LED panel 2. The LEDs, however, are not pre-programmed. To match the pre-printed label, the LED settings must be entered as shown in the User-programmable LEDs section of chapter 5. The LEDs are fully user-programmable. The default labels can be replaced by user-printed labels for both panels as explained in the next section.

Figure 4-50: LED panel 2 (default labels)



#### 4.2.4.3 Graphical front panel

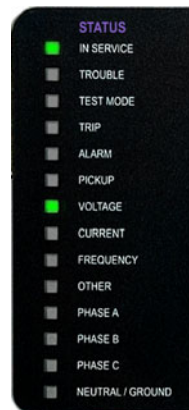
The graphical front panel has 14 LEDs. LEDs 1 to 5 are fixed status LEDs, and LEDs 6 to 14 are programmable.

#### Status indicators

- **IN SERVICE** — Indicates that control power is applied, all monitored inputs/outputs and internal systems are fine, the relay's test mode is disabled, and the relay is in (online) Programmed mode (under **Settings > Product Setup > Installation**)
- **TROUBLE** — Indicates that the relay has detected an internal problem. Check the self-test messages outlined at the end of the Commands and Targets chapter, and view the event records under **Actual Values > Records**. For a beta / pre-release, this LED is always on.

- **TEST MODE** — Indicates that the relay is in Isolated (solid) or Forcible (flashing) test mode. For information, see the Test Mode section in the Settings chapter.
- **TRIP** — Indicates that the selected FlexLogic operand serving as a trip input has operated. Set the operand under **Settings > Product Setup > User-Programmable LEDs > Trip & Alarm LEDs**. This indicator latches; initiate the reset command to reset the latch.
- **ALARM** — Indicates that the selected FlexLogic operand serving as an alarm input has operated. Set the operand under **Settings > Product Setup > User-Programmable LEDs > Trip & Alarm LEDs**.

Figure 4-51: Example of LEDs on graphical front panel



### User-programmable event-cause indicators

Event-cause LEDs are below the status LEDs. They are turned on or off by protection elements that have their respective target setting selected as “Self-Reset” or “Latched.” If set to “Self-Reset,” then the corresponding event cause LED remains on as long as the operand associated with the element remains asserted. If set to “Latched” and asserted, then it remains on until the operand is reset and then a reset command initiated.

All elements that are able to discriminate faulted phases can independently turn on or off the phase A, B, or C LEDs. This includes phase instantaneous overcurrent, phase undervoltage, and so on. This means that the phase A, B, and C operate operands for individual protection elements are ORed to turn on or off the phase A, B, or C LEDs.

The LEDs have defaults and can be configured to show instead the status of any FlexLogic operand.

The labelling area has a clear cover for custom labels. A utility is available to print stick-on labels, as outlined later in this chapter.

These LEDs are programmed by default as follows:

- **PICKUP — LED 6** — Indicates that an element is picked up, and hence a trip can be imminent
- **VOLTAGE — LED 7** — Indicates voltage was involved
- **CURRENT — LED 8** — Indicates current was involved
- **FREQUENCY — LED 9** — Indicates frequency was involved
- **OTHER — LED 10** — Indicates a composite function was involved
- **PHASE A — LED 11** — Indicates phase A was involved
- **PHASE B — LED 12** — Indicates phase B was involved
- **PHASE C — LED 13** — Indicates phase C was involved
- **NEUTRAL/GROUND — LED 14** — Indicates that neutral or ground was involved

## 4.2.5 Front panel labelling

### 4.2.5.1 Enhanced front panel

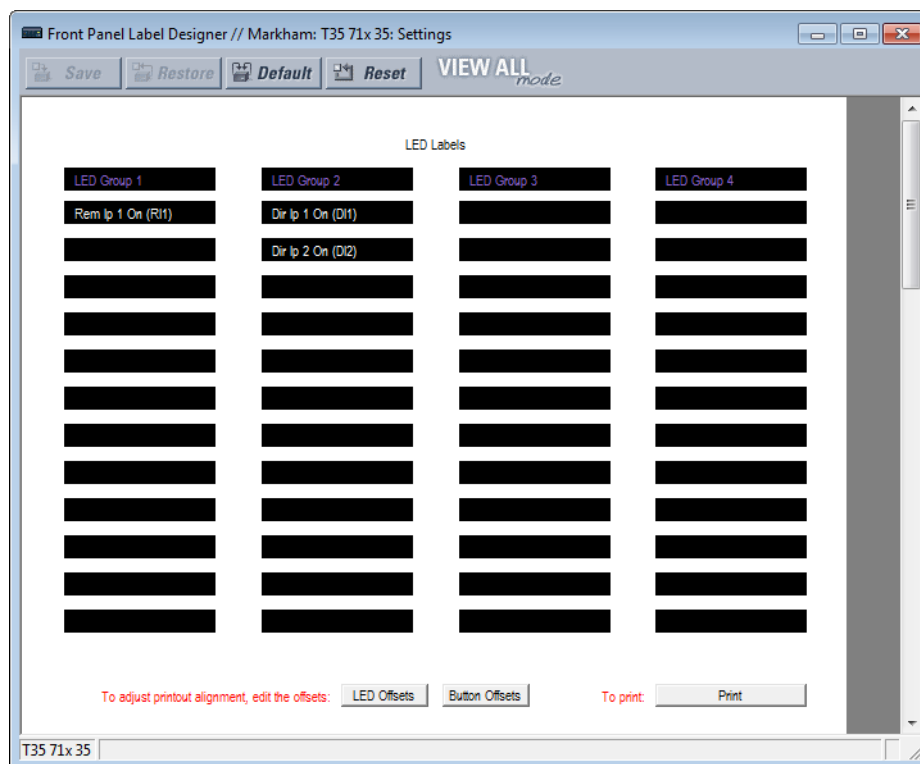
The following procedure requires these pre-requisites:

- The UR front panel label cutout sheet (GE part number 1006-0047) has been downloaded from <http://www.gegridsolutions.com/products/support/ur/URLEDenhanced.doc> and printed
- Small-bladed knife

To create custom LED and pushbuttons labels for the enhanced front panel:

1. Start the EnerVista UR Setup software.
2. If not already copied to the Offline Window area, right-click the online device and select the **Add Device to Offline Window** option. Click the **Receive** button in the window that opens to save the settings file to the Offline Window area.
3. Type labels as follows. Select the **File > Front Panel Report**. The window opens.

Figure 4-52: Enhanced front panel label designer



4. Enter the text to appear next to each LED and above each user-programmable pushbutton in the fields provided. The **LED Offsets** and **Button Offsets** buttons move all labels left/right and up/down on the page (they both do the same action, so use either button). The **Button Offsets** button does not display when there are no pushbuttons to customize.
5. Feed the UR front panel label cutout sheet into a printer and press the **Print** button in the front panel report window.
6. When printing is complete, fold the sheet along the perforated lines and punch out the labels.
7. Remove the UR label insert tool from the package and bend the tabs as described in the following procedures. These tabs are used for removal of the default and custom LED labels.



Use the tool with the printed side containing the GE part number facing the user.

The label package shipped with every G30 contains the three default labels, the custom label template sheet, and the label removal tool.

If the default labels are suitable for your application, insert them in the appropriate slots and program the LEDs to match them. If you require custom labels, use the following procedures to remove the original labels and insert the new ones.

To set up and use the label removal tool:

1. Bend the tabs at the left end of the tool upwards as shown.



Bend the tab at the center of the tool tail as shown.



To remove the LED labels from the G30 front panel and insert the custom labels:

1. Use the knife to lift the LED label and slide the label tool underneath. Ensure that the bent tabs are pointing away from the relay.





- Slide the label tool under the LED label until the tabs snap out as shown. This attaches the label tool to the LED label.



- Remove the tool and attached LED label as shown.



- Slide the new LED label inside the pocket until the text is properly aligned with the LEDs, as shown.



To remove the user-programmable pushbutton labels from the G30 front panel and insert the custom labels:

- Use the knife to lift the pushbutton label and slide the tail of the label tool underneath, as shown. Ensure that the bent

tab points away from the relay.



- Slide the label tool under the user-programmable pushbutton label until the tabs snap out as shown. This attaches the label tool to the user-programmable pushbutton label.

4



- Remove the tool and attached user-programmable pushbutton label.



- Slide the new user-programmable pushbutton label inside the pocket until the text is properly aligned with the

buttons.



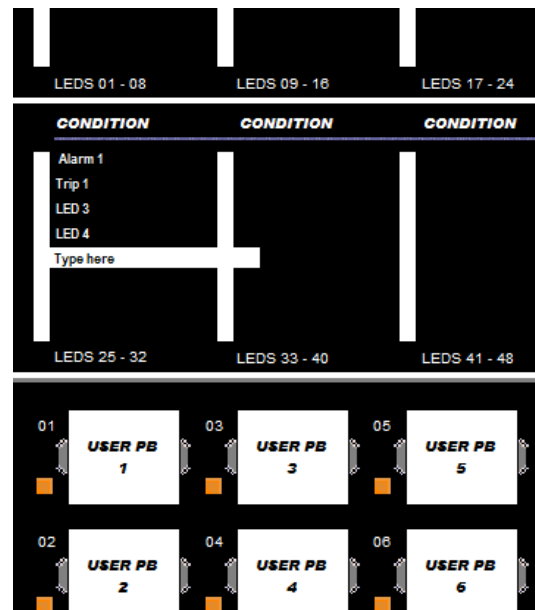
#### 4.2.5.2 Basic front panel

After programming LEDs and pushbuttons under **Settings > Product Setup > User-Programmable Leds** and **User-Programmable Pushbuttons**, labels can be created for the front panel.

To create LED and pushbutton labels for a basic front panel:

1. In the EnerVista software, if the G30 is not already listed in the Offline Window area, add it by right-clicking it and selecting the **Add Device to Offline Window** option.
2. Click the **File > Front Panel Report** menu item and select the device.
3. In the Front Panel Report window, double-click an LED or pushbutton slot and type a label. If you need to see the existing front panel remotely, access **Actual Values > Front Panel** for the online device. If you need to see the In the figure, note that labelling is being done for the third set of LEDs because the second panel of LEDs was factory-labelled.

Figure 4-53: Basic front panel label designer (LEDs shown)



4. Optionally save the changes by clicking the **Save** icon on the toolbar.
5. Click the **Print** icon on the toolbar. Consider printing to PDF format and adjusting the zoom for appropriate label size, then print on a physical printer.
6. Cut labels as a block or individually, for example with scissors or an Exacto knife.
7. If there is a plastic cover over the front panel, remove it by gently pushing in on the right side and lifting off the cover.
8. Remove the plastic cover over the LEDs or pushbutton(s) using a screw driver.
9. Insert the labels.
10. Re-attach the plastic covers.

#### 4.2.5.3 Graphical front panel

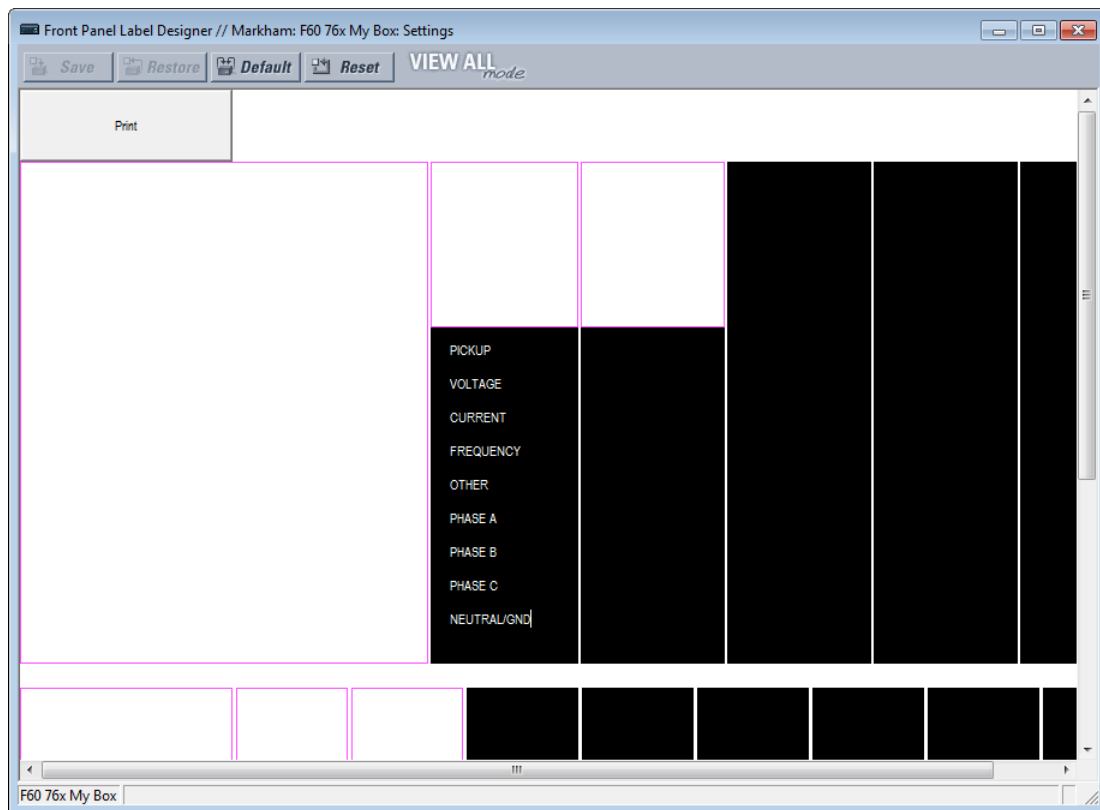
The G30 includes software for labelling the LEDs and pushbuttons on the graphical front panel and a sticker sheet with pre-printed and blank labels. The pre-printed labels are on the top-left of the template sheet, and the blank labels are on the bottom-right. Use the pre-printed labels, or use the designer provided in the software and print labels onto the template. One sheet is provided.

The example shows LED labeling, with pushbutton labeling below it (cut off).

To create LED and pushbutton labels for the front panel:

1. In the EnerVista software, in the Online or Offline Window area, access **Settings > Front Panel Label Designer** or **Front Panel Label Designer** (at the product root level). The designer window opens with pre-configured labels.
2. Under **File > Print Setup**, change the page orientation to **Landscape**.
3. In the label designer window, delete all labels not wanted for printing. This can be done by clicking the **Reset** button to clear all labels, or by selecting each unwanted label and deleting it. Otherwise, all labels displayed print on the template and use up the template. If you make a mistake, exit the window and open it again to view the default labels.
4. Based on the location on the template on which to print, create the labels by typing in the appropriate slots.

Figure 4-54: Front panel label designer for graphical front panel



5. Click the **Print** button in the window and select the printer.
6. Once printed, peel the labels off the template and stick them on the front panel. For the enhanced and graphical front panels, they go over the clear plastic inserts, not under. For the basic front panel, they go under or over the plastic covers.

Any changes are not saved. Each time that the label designer window opens, the original template displays. Any labels deleted are not lost.

## 4.2.6 Menu navigation

Press the **MENU** key to display selections or home page. Each press of the key advances through the following main headings:

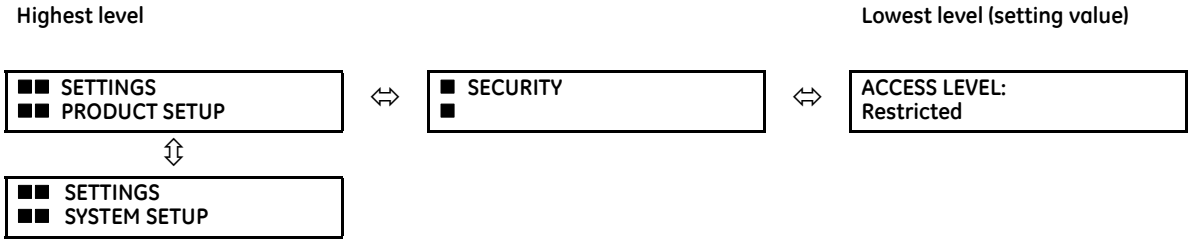
- Actual Values
- Settings
- Commands
- Targets
- Factory Service
- User displays (when enabled)

### 4.2.6.1 Enhanced and basic front panels

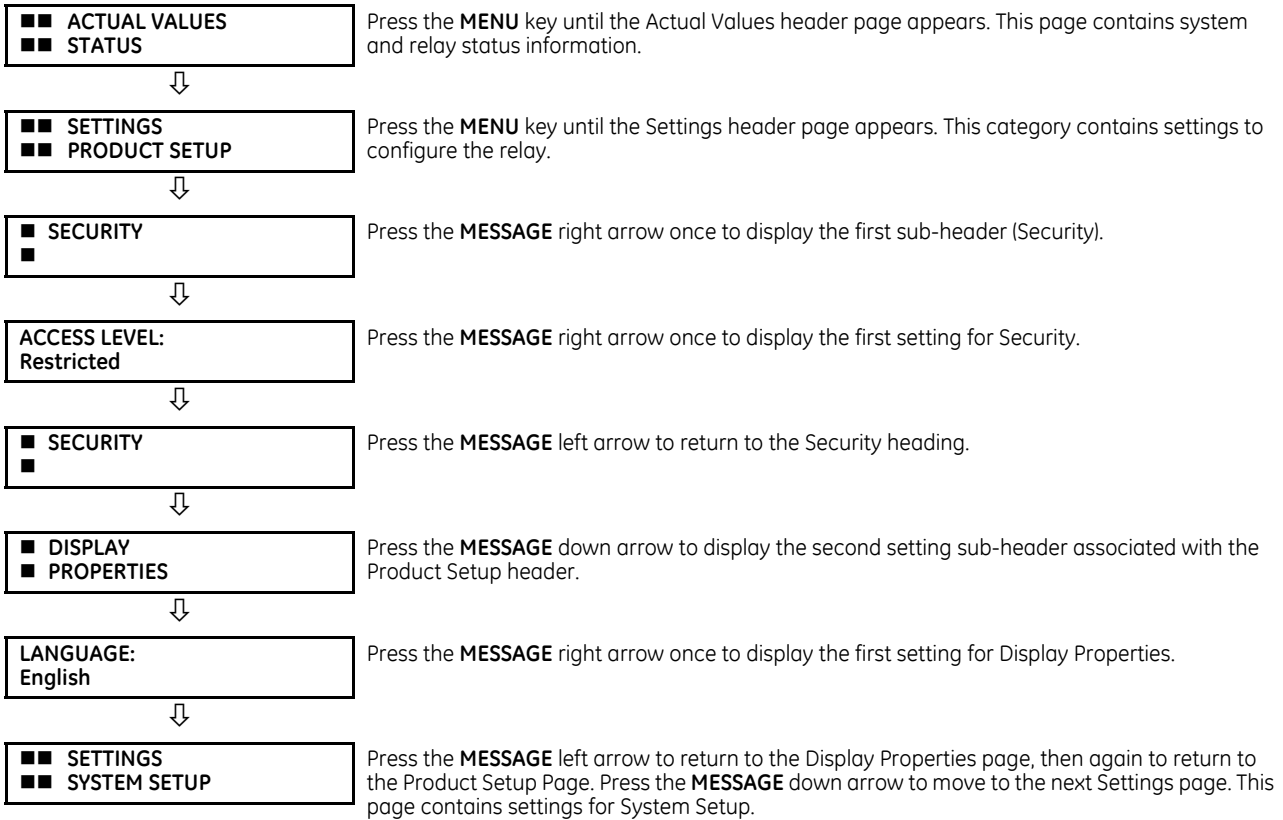
The setting and actual value pages are arranged hierarchically. Header display pages are indicated by double scroll bars (■■), while sub-header pages are indicated by a single scroll bar (■). The header display pages represent the highest level of the hierarchy and the sub-header display pages fall below this level. Use the down, right, left, and up arrows to navigate the menu. The **MESSAGE** up and down arrow keys move within a group of headers, sub-headers, setting values, or actual

values. Continually pressing the **MESSAGE** right arrow from a header display displays specific information for the category. Conversely, continually pressing the **MESSAGE** left arrow from a setting value or actual value display returns to the header display.

Default values are indicated in this instruction manual in mixed case. In the example shown here, the default access level is Restricted.



**Example**



**4.2.6.2 Graphical front panel**

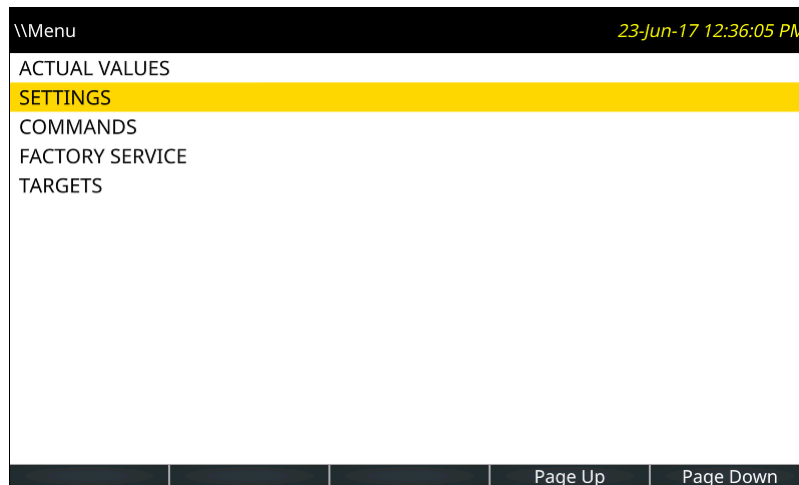
Access the main menu by pressing the **Home** pushbutton, then the **Menu** Tab pushbutton.

Use the Up and Down arrow pushbuttons to select a submenu, then press the Right or **ENTER** pushbutton to drill into that submenu. The Left and **ESCAPE** pushbuttons back up the menu hierarchy.

The **Page Up** and **Page Down** Tab pushbuttons also navigate through the list. When there is only a single page of options, they jump to the first and last entries.

The options displayed depend on order code.

Figure 4-55: Main menu on graphical front panel



## 4.2.7 Change settings

### 4.2.7.1 Enhanced and basic front panels

#### Numerical data

Each numerical setting has its own minimum, maximum, and increment value associated with it. These parameters define what values are acceptable for a setting.

**FLASH MESSAGE TIME: 10.0 s** For example, select the **SETTINGS** ⇒ **PRODUCT SETUP** ⇒ **DISPLAY PROPERTIES** ⇒ **FLASH MESSAGE TIME** setting.



**MINIMUM: 0.5**  
**MAXIMUM: 10.0** Press the **HELP** key to view the minimum and maximum values. Press the key again to view the next context sensitive help message.

Two methods of editing and storing a numerical setting value are available.

- **0 to 9 and decimal point** — The relay numeric keypad works the same as a calculator. A number is entered one digit at a time. The leftmost digit is entered first and the rightmost digit is entered last. Pressing the **MESSAGE** left arrow or pressing the **ESCAPE** key, returns the original value to the display.
- **VALUE keys** — The **VALUE** up arrow increments the displayed value by the step value, up to the maximum value allowed. While at the maximum value, pressing the **VALUE** up arrow again allows the setting selection to continue upward from the minimum value. The **VALUE** down arrow decrements the displayed value by the step value, down to the minimum value. While at the minimum value, pressing the **VALUE** down arrow again allows the setting selection to continue downward from the maximum value.

**FLASH MESSAGE TIME: 2.5 s** As an example, set the flash message time setting to 2.5 seconds. Press the appropriate numeric keys in the sequence "2 . 5". The display message changes as the digits are being entered.



**NEW SETTING HAS BEEN STORED** Until **ENTER** is pressed, editing changes are not registered by the relay. Press **ENTER** to store the new value in memory. This flash message momentarily appears as confirmation of the storing process. Numerical values that contain decimal places are rounded-off if more decimal place digits are entered than specified by the step value.

## Enumeration data

Enumeration settings have data values that are part of a set, whose members are explicitly defined by a name. A set has two or more members.

<b>ACCESS LEVEL:</b> Restricted	For example, the selections available for <b>ACCESS LEVEL</b> are "Restricted," "Command," "Setting," and "Factory Service."
------------------------------------	--

Enumeration type values are changed using the **VALUE** keys. The **VALUE** up arrow displays the next selection while the **VALUE** down arrow displays the previous selection.

<b>ACCESS LEVEL:</b> Setting	If the <b>ACCESS LEVEL</b> needs to be "Setting," press the <b>VALUE</b> keys until the proper selection displays. Press <b>HELP</b> at any time for the context sensitive help messages.
---------------------------------	---

⇕

<b>NEW SETTING HAS BEEN STORED</b>	Changes are not registered by the relay until the <b>ENTER</b> key is pressed. Pressing <b>ENTER</b> stores the new value in memory. This flash message momentarily appears as confirmation.
--	--

# 4

## Alphanumeric text

Text settings have data values that are fixed in length, but user-defined in characters. They can be upper-case letters, lower-case letters, numerals, and a selection of special characters.

There are several places where text messages can be programmed to allow the relay to be customized for specific applications. One example is the Message Scratchpad. Use the following procedure to enter alphanumeric text messages.

For example, enter the text "Breaker #1".

1. Press the decimal point to enter text edit mode.
2. Press the **VALUE** keys until the character 'B' appears; press the decimal key to advance the cursor to the next position.
3. Repeat step 2 for the remaining characters: r,e,a,k,e,r, ,#,1.
4. Press **ENTER** to store the text.
5. If you have any problem, press **HELP** to view context sensitive help. Flash messages appear sequentially for several seconds each. For the case of a text setting message, pressing **HELP** displays how to edit and store new values.

### 4.2.7.2 Graphical front panel

When enabling an element in the EnerVista software that outputs to an actual value, the actual values menu is not updated on the graphical front panel via Ethernet connection when that menu is active on the graphical front panel. Navigate out and back into the menu for activation.

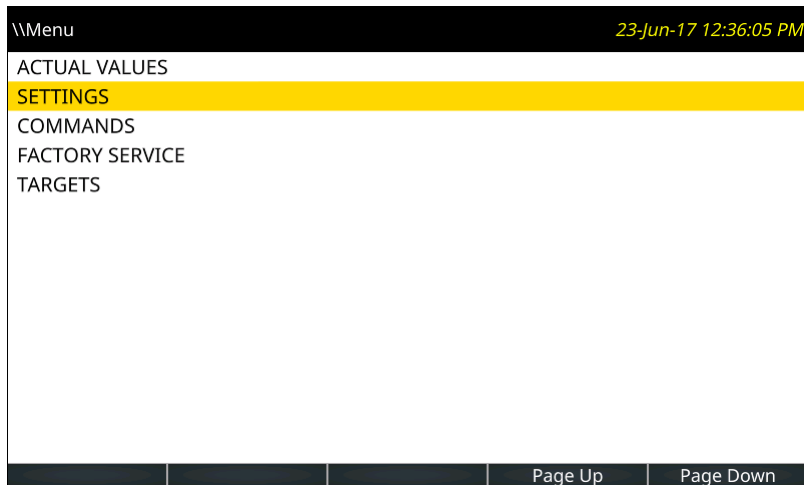
## Numerical data

This example outlines how to change the FLASH MESSAGE TIME setting. Flash messages are status, warning, error, and information messages displayed in response to certain key presses during settings programming. An example is a confirmation message upon saving settings. This setting specifies how long to display the message.

Press the **Menu** pushbutton to display the main menu.

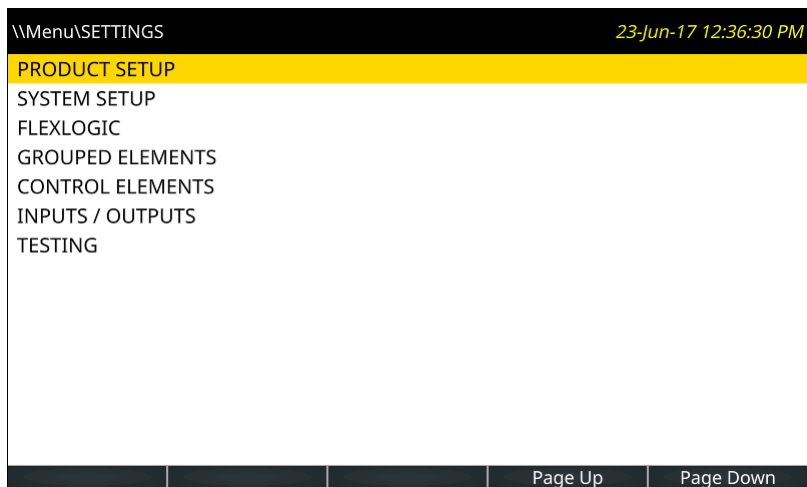


Figure 4-56: Main menu



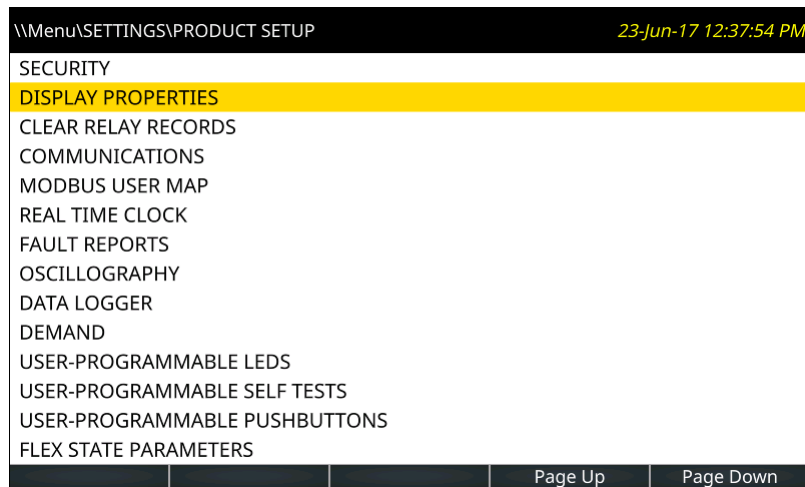
Use the Up or Down pushbutton to select **SETTINGS**, then press the Right or **ENTER** pushbutton.

Figure 4-57: Settings menu



With **PRODUCT SETUP** selected, press the Right or **ENTER** pushbutton.

Figure 4-58: Product Setup menu



Use the Up or Down pushbutton to select **DISPLAY PROPERTIES**, then press the Right or **ENTER** pushbutton.

Figure 4-59: Display Properties menu



Use the Up or Down pushbutton to select **FLASH MESSAGE TIME**, then press the Right or **ENTER** pushbutton. If the relay is configured to require login to edit settings, and the user is not already logged in, the login page displays. When the user has successfully logged in, the setting is opened for edit. As the **FLASH MESSAGE TIME** setting accepts a numerical value, a keypad displays. The time is to be changed to 4.0 seconds.

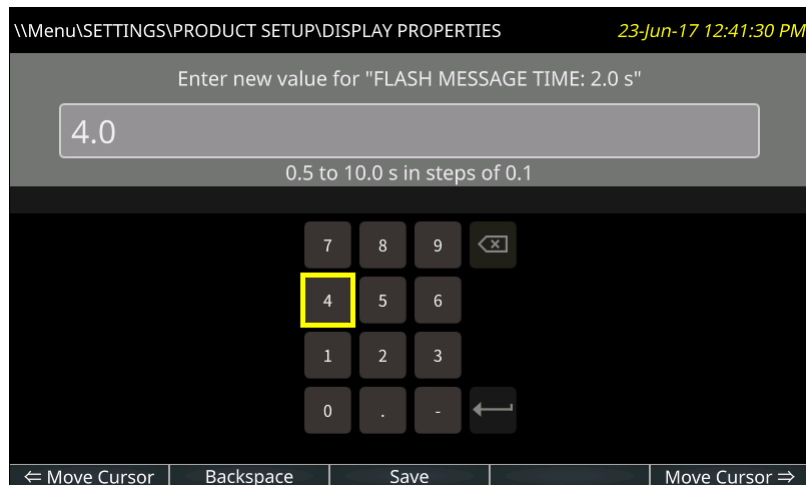
The current setting displays. A flashing cursor line marks the insertion point, initially positioned after the last character of the setting. The setting range displays under the text.

Press the **<-- Move Cursor** and **Move Cursor -->** Tab pushbuttons to move the insertion point. Place it after the 2.

Press the **Backspace** Tab pushbutton to remove the character to the left of the cursor, in this case the 2.

Using the arrow keys, enter another time, for example 4 for four seconds. These Up, Down, Left, and Right pushbuttons move the keypad key selector. Pressing the **ENTER** pushbutton with the - key selected inverts the sign. Pressing the **ENTER** pushbutton with the decimal point selected enters that character at the insertion point. Push **ENTER** now to accept the 4.

Figure 4-60: Settings page with numeric keypad



Press the **Save** Tab pushbutton, which does a range check on the value, saves the setting when valid, closes the page, and displays the previous page.

When a setting is not saved due to an invalid value, a message flashes, for example being out of range. In cases where the relay needs to be restarted for settings to take effect, the flash message advises.

Setting entry can be cancelled without impact on the original value by pressing the **ESCAPE** or **Home** pushbutton.

### Alphanumeric text

Settings that accept alphanumeric values display a keyboard. An example is a pushbutton name.

The **&123** key toggles between text and numbers.

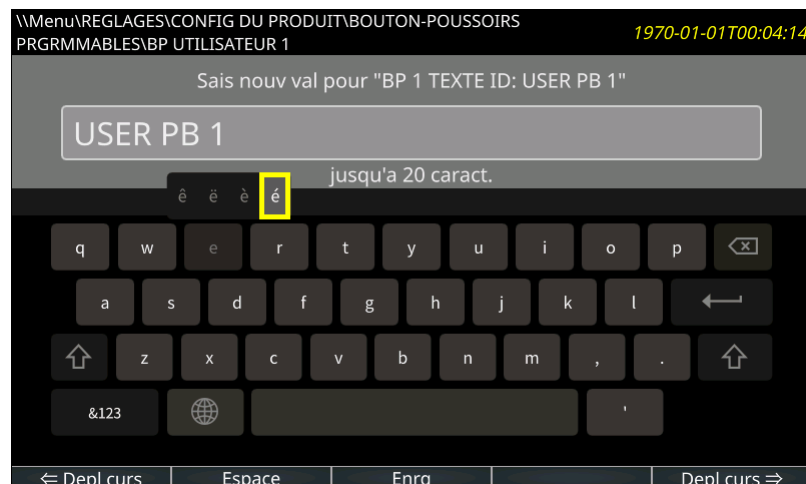
The shift key (up arrow on keyboard) is green upon activation, while the keyboard letters switch to upper case. Double-click the shift key to lock capital lettering, or full capitals.

The globe key (shown greyed-out) toggles the keyboard language between English and another display language selected, for example between English and French. (The second language needs to be activated under **Settings > Product Setup > Display Properties**.)

For Japanese and Chinese, up to 10 characters can be input in a field, not 20.

To add accents, highlight a key and hold the **ENTER** pushbutton on the graphical front panel. Any special characters associated with the key display.

Figure 4-61: Settings page with keyboard and accents



## 4.2.8 View actual values

### 4.2.8.1 Graphical front panel

In addition to data viewable in the **Actual Values** menu on the front panel, phasor diagrams and metered data can be displayed. The metered data can be arranged as a table.

The update rate of metered values is 500 ms.

A phasor page for each configured AC Source and up to five user-configurable metering pages can be displayed. The phasor pages are not configurable. Each phasor page shows a phasor plot and numerical values of all currents, voltages, and symmetrical components of a single AC source.

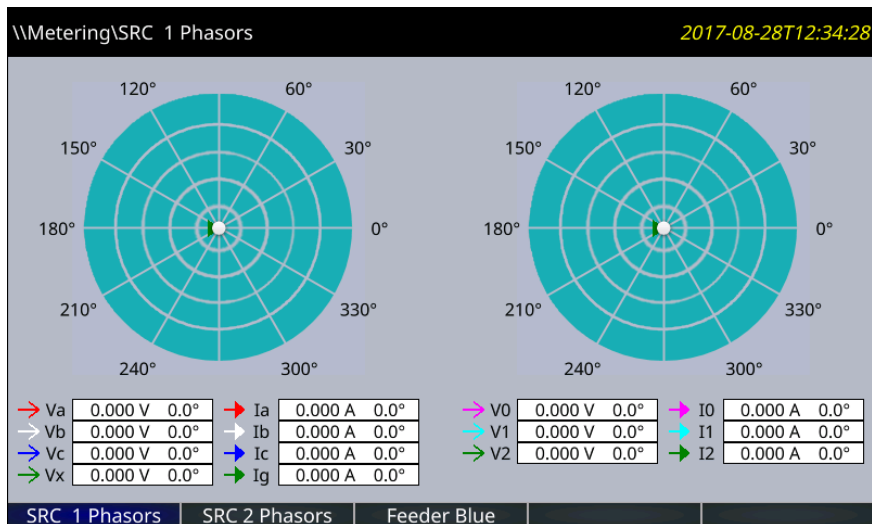
The Annunciator and Metering pages can be configured to display data. Each has a user-configured number of rows and columns. Each cell can include either configurable static text or the value of a selected FlexLogic operand, FlexAnalog operand, or actual value.

To display a metering page, press the **Home** pushbutton, then the **Metering** Tab pushbutton. The first metering page opens, with phasor pages listed before tabular pages. The Tab pushbuttons display any other metering page, as do the Up, Down, Left and Right pushbuttons. The current page is highlighted with a blue Tab pushbutton.

Each phasor page has a name, which consists of the value of the SOURCE NAME # setting appended with " Phasors." Phasor pages that have no configured CTs or VTs do not have a Tab pushbutton, and phasor pages that have no configured cells cannot be displayed.

4

Figure 4-62: Phasor display



The configurable name displays in the header and Tab pushbutton label. Factory default names are Page 1, Page 2, and so on.

Figure 4-63: Metered actual values

\Metering\Feeder Blue			2017-08-28T12:35:43
Phase AB	Phase BC	Phase CA	
0.000	0.000	0.000	V
Phase A	Phase B	Phase C	
0.000	0.000	0.000	A
0.000	0.000	0.000	W
0.000	0.000	0.000	VAR
0.000	0.000	0.000	PF
SRC 1 Phasors	SRC 2 Phasors	Feeder Blue	

The phasor sources are configured under **Settings > System Setup > Signal Sources**. The tables to display the actual values are configured in the software under **Settings > Product Setup > Graphical Panel > Metering Editor**.

## 4.2.9 Breaker control

The G30 can interface with associated circuit breakers. In many cases the application monitors the state of the breaker, that can be presented on front panel LEDs, along with a breaker trouble indication. Breaker operations can be manually initiated from the front panel keypad or automatically initiated from a FlexLogic operand. A setting is provided to assign names to each breaker; this user-assigned name is for the display of related flash messages. These features are provided for two breakers; the user can use only those portions of the design relevant to a single breaker, which must be breaker 1.

It is assumed in the following discussion that the **SETTINGS ⇒ SYSTEM SETUP ⇒ BREAKERS ⇒ BREAKER 1(2) ⇒ BREAKER FUNCTION** setting is "Enabled" for each breaker.

### 4.2.9.1 Control mode selection and monitoring

Installations can require that a breaker be operated in the three-pole only mode (3-pole), or in the one and three-pole (1-pole) mode, selected by setting. If the mode is selected as three-pole, a single input tracks the breaker open or closed position. If the mode is selected as one-pole, all three breaker pole states must be input to the relay. These inputs must be in agreement to indicate the position of the breaker.

For the following discussion it is assumed that the **SETTINGS ⇒ SYSTEM SETUP ⇒ BREAKERS ⇒ BREAKER 1(2) ⇒ BREAKER 1(2) PUSH BUTTON CONTROL** setting is "Enabled" for each breaker.

### 4.2.9.2 Front panel (user key) control

After the 30 minute interval during which command functions are permitted after a correct command password, the user cannot open or close a breaker via the keypad. The following discussions begin from the not-permitted state.

### 4.2.9.3 Control of two breakers

For the following setup example, the **(Name)** field represents the user-programmed variable name.

For this example, the relay is connected and programmed for both breaker 1 and breaker 2. The **USER 1** key performs the selection of which breaker is to be operated by the **USER 2** and **USER 3** keys. The **USER 2** key manually closes the breaker, and the **USER 3** key manually opens the breaker.

**ENTER COMMAND  
PASSWORD**

This message appears when the **USER 1**, **USER 2**, or **USER 3** key is pressed and a **COMMAND PASSWORD** is required, that is, if **COMMAND PASSWORD** is enabled and no commands have been issued within the last 30 minutes.

**Press USER 1  
To Select Breaker**

This message appears if the correct password is entered or if none is required. This message displays for 30 seconds or until the **USER 1** key is pressed again.

**BKR1-(Name) SELECTED  
USER 2=CLS/USER 3=OP**

This message displays after the **USER 1** key is pressed for the second time. Three possible actions can be performed from this state within 30 seconds as per the following items (1), (2) and (3).

(1)

**USER 2 OFF/ON  
To Close BKR1-(Name)**

If the **USER 2** key is pressed, this message appears for 20 seconds. If the **USER 2** key is pressed again within that time, a signal is created that can be programmed to operate an output relay to close breaker 1.

(2)

**USER 3 OFF/ON  
To Open BKR1-(Name)**

If the **USER 3** key is pressed, this message appears for 20 seconds. If the **USER 3** key is pressed again within that time, a signal is created that can be programmed to operate an output relay to open breaker 1.

(3)

**BKR2-(Name) SELECTED  
USER 2=CLS/USER 3=OP**

If the **USER 1** key is pressed at this step, this message appears showing that a different breaker is selected. Three possible actions can be performed from this state as per (1), (2) and (3). Repeatedly pressing the **USER 1** key alternates between available breakers. Pressing keys other than **USER 1**, **2**, or **3** at any time cancels the breaker control function.

#### 4.2.9.4 Control of one breaker

For this application, the relay is connected and programmed for breaker 1 only. Operation for this application is identical to that described in the previous section for two breakers.

### 4.2.10 Change passwords

The information in this section refers to password security. For information on how to set the password for the first time or change CyberSentry passwords, see the previous chapter or the Settings > Product Setup > Security > CyberSentry section in the next chapter.

The G30 supports password entry from a local or remote connection.

Local access is defined as access to settings or commands via the front panel. This includes both keypad entry and the RS232 port. Remote access is defined as access to settings or commands via any rear communications port. This includes both Ethernet and RS485 connections. Any change to the local or remote password enables this functionality.

When entering a settings or command password via EnerVista or any serial interface, the user must enter the corresponding connection password. If the connection is to the back of the G30, the remote password must be used. If the connection is to the RS232 port of the front panel, the local password must be used.

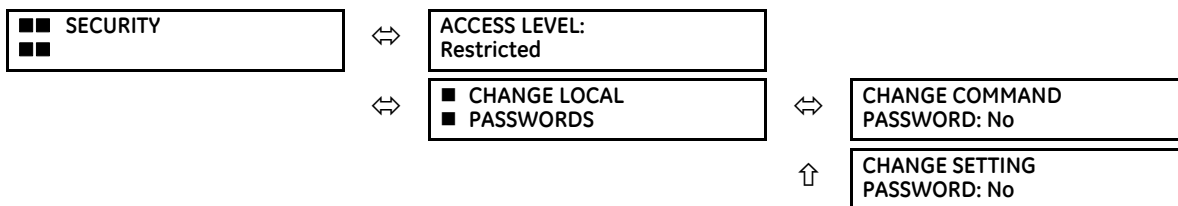
There are two user security access levels, setting and command, for which you can set a password for each. Use of a password for each level controls whether users can enter commands or change settings. Another option is to specify setting and/or command access for individual user accounts.

- **Setting** — Allows the user to make any changes to any of the setting values:
  - Changing any setting
  - Test mode operation
- **Command** — Restricts the user from making any settings changes, but allows the user to perform the following operations:
  - Changing the state of virtual inputs
  - Clearing the event records

- Clearing the oscillography records
- Changing the date and time
- Clearing the breaker arcing current
- Clearing energy records
- Clearing the data logger
- Clearing the user-programmable pushbutton states

To enter the initial setting or command password:

1. Press the **MENU** key until the **SETTINGS** header flashes momentarily and the **PRODUCT SETUP** message appears on the display.
2. Press the **MESSAGE** right arrow until the **ACCESS LEVEL** message appears on the display.
3. Press the **MESSAGE** down arrow until the **CHANGE LOCAL PASSWORDS** message appears on the display.
4. Press the **MESSAGE** right arrow until the **CHANGE SETTING PASSWORD** or **CHANGE COMMAND PASSWORD** message appears on the display.



5. After the **CHANGE...PASSWORD** message appears on the display, press the **VALUE** up or down arrow to change the selection to "Yes."
6. Press the **ENTER** key and the display prompts you to **ENTER NEW PASSWORD**.
7. Type in a password and press the **ENTER** key.
8. When **VERIFY NEW PASSWORD** displays, re-type the password and press **ENTER**.



9. When the **NEW PASSWORD HAS BEEN STORED** message appears, your new Setting (or Command) password is active.

### 4.2.11 Invalid password entry

By default, when an incorrect Command or Setting password has been entered via the front panel three times within five minutes, the **LOCAL ACCESS DENIED** FlexLogic operand is set to "On" and the G30 does not allow settings or command level access via the front panel for five minutes.

By default, when an incorrect Command or Setting password has been entered via any external communications interface three times within five minutes, the **REMOTE ACCESS DENIED** FlexLogic operand is set to "On" and the G30 does not allow settings or command access via the any external communications interface for five minutes. The **REMOTE ACCESS DENIED** FlexLogic operand is set to "Off" after five minutes for a Command password or 30 minutes for a Settings password.

These default settings can be changed in EnerVista under **Settings > Product Setup > Security**.

## 4.3 Logic diagrams

Logic diagrams in this instruction manual provide an overview of function and settings. A logic diagram is based on

- Inputs-on the left side, which are setting and operands
- Logical gates, which is Boolean algebra to combine logical lines using AND, OR, NOT, and other gates to get a new logical state
- Logical operators, which are timers, one-shot operations, latches, and so on
- Outputs-on the right side, which are products of the manipulations with inputs, logical gates, and logical operators to produce new operands and define the output state of the element

True and false values are denoted by 1 and 0 respectively. A function usually is high/on/enabled when 1.

Reading from right to left in the following diagram, the **TRIP BUS 1 OP** and **TRIP BUS 1 PKP** FlexLogic operands on the right side are triggered when either the settings or reset latch in the middle of the diagram is triggered. When this applies, the **TRIP BUS 1 OP** operand is triggered after the delay set by the **TRIP BUS 1 PICKUP DELAY** or **TRIP BUS 1 RESET DELAY** setting, while the **TRIP BUS 1 PKP** operand initiates immediately. The settings or reset latch in the middle of the diagram is triggered as follows.

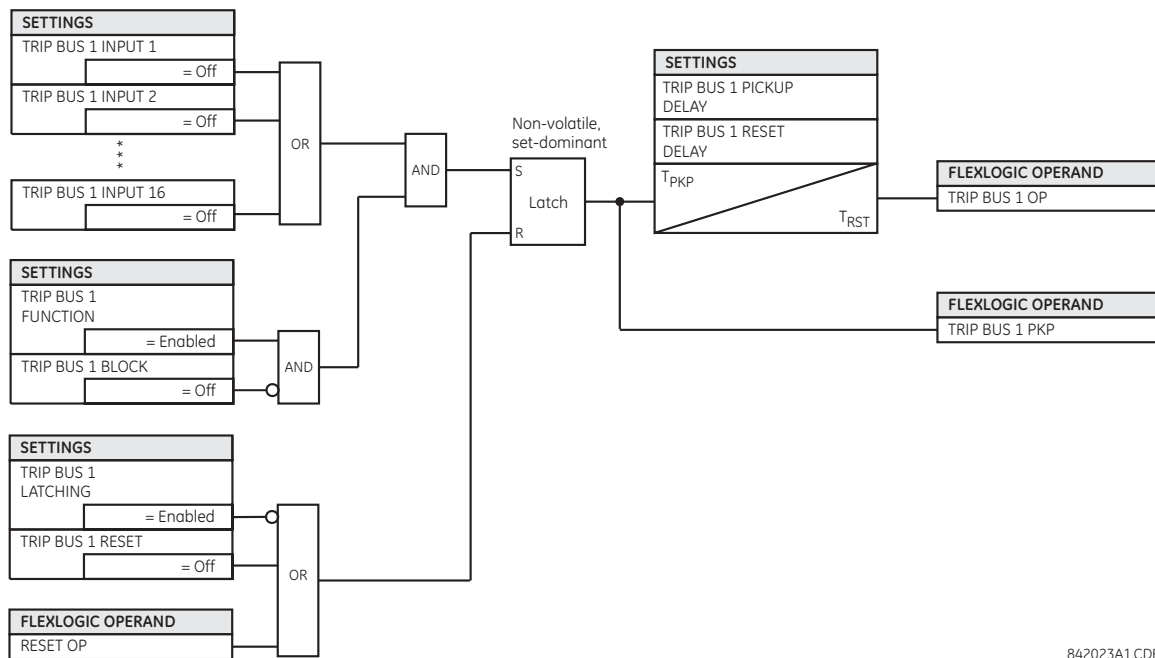
- For the reset, one of three conditions are required to meet the OR requirement shown at the bottom left. That is, the **TRIP BUS 1 LATCHING** setting must be 0=Disabled (which is negated by the NOT function to become 1=Enabled), output from the **TRIP BUS 1 RESET** FlexLogic operand must be 1, or output from the **RESET OP** FlexLogic operand must be 1.
- For the settings, one of 16 input conditions at the top left must be met for the OR, the **TRIP BUS 1 FUNCTION** must be Enabled, and the **TRIP BUS 1 BLOCK** output must output as 0, which is then negated/reversed by NOT to become 1.

**Table 4-2: Logic diagram symbols**

Symbol	Description
= Off	Output from FlexLogic operand, so user-defined
= Enabled	1 = Enabled and 0 = Disabled
OR	Any function input on the left side satisfies the condition
AND	All functions input on the left side are required to satisfy the condition
○	Not. Negates/reverses the output, for example 0 becomes 1.
●	Connection
S, R	Set, Reset
T <sub>PKP</sub>	Timer pickup. Triggered by the settings latch in the diagram.
T <sub>RST</sub>	Timer reset. Triggered by the reset latch in the diagram.



Figure 4-64: Logic diagram



842023A1.CDR

## 4.4 FlexLogic design using Engineer

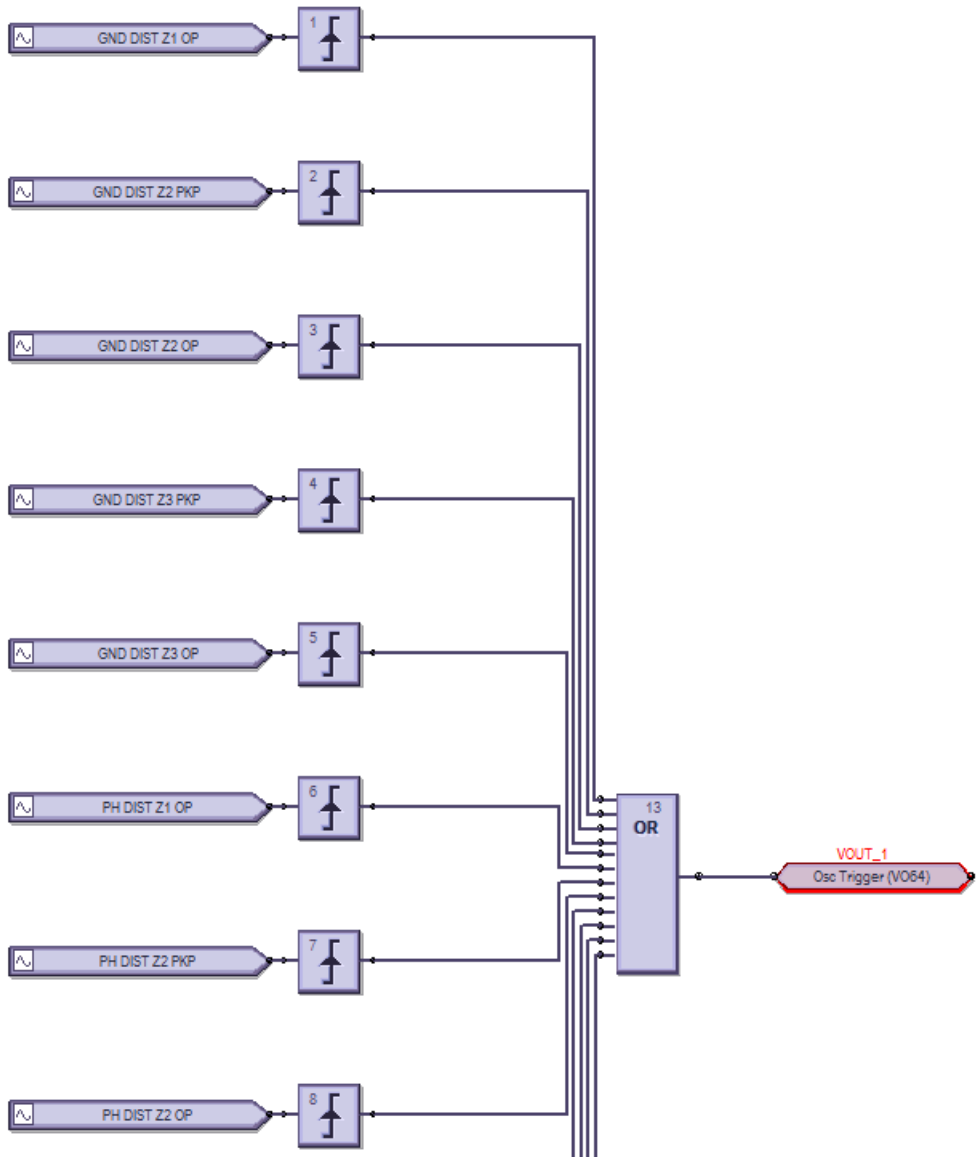
Parts of EnerVista Viewpoint Engineer software are integrated in the EnerVista UR Setup software. Engineer can be used to create and modify FlexLogic that is used by a device, such as to monitor output, monitor triggers, and create self-tests.

Features include

- Automatically displays existing FlexLogic
- Drag-and-drop interface
- Open multiple tabs and edit simultaneously
- Display symbols in IEC, ISO, or UR formats
- Export a diagram as BMP file or copy it to the clipboard for import into other applications
- Scale and print files in various paper sizes
- Works with all UR firmware versions

The figure shows an example where several inputs are used to trigger an output. With the OR function, any one of the inputs can trigger the output.

Figure 4-65: Inputs triggering output in Engineer



The process is as follows:

- Modify or create a logic diagram in the Offline Window area of the EnerVista UR Setup software
- Compile it and troubleshoot any errors
- The logic populates automatically into the FlexLogic Equation Editor
- Upload the file to the live device
- Monitor the output

This section explains how to use Engineer. It outlines the following topics:

- Design logic
- Send file to and from device
- Monitor logic
- View front panel
- Generate connectivity report
- Preferences

- Toolbars

### 4.4.1 Design logic

FlexLogic can be created with a block diagram. Note that although work is completed in the Offline Window area of the software, communication occurs with the online device, for example when switching to monitoring mode.

The following procedures are outlined:

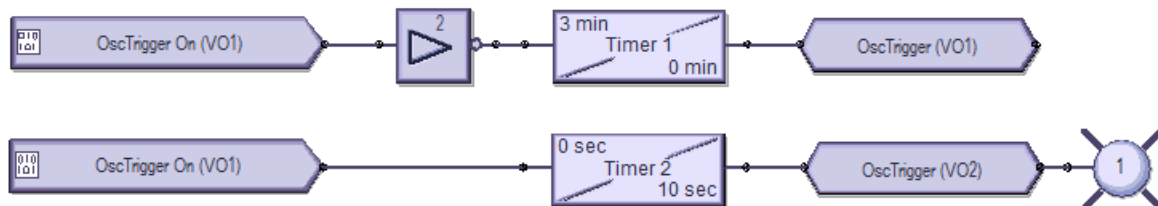
- Examples
- Add existing FlexLogic equations
- Create a logic diagram/sheet
- Rapidly add logic blocks in sequence
- Connect two logic diagrams/sheets
- Optimize the logic
- Change logic order
- Search logic
- Exclude sheet from compile

#### 4.4.1.1 Examples

The symbols are displayed in the UR format.

#### Create oscillography trigger every three minutes

Figure 4-66: Three-minute timer turns on LED for 10 seconds



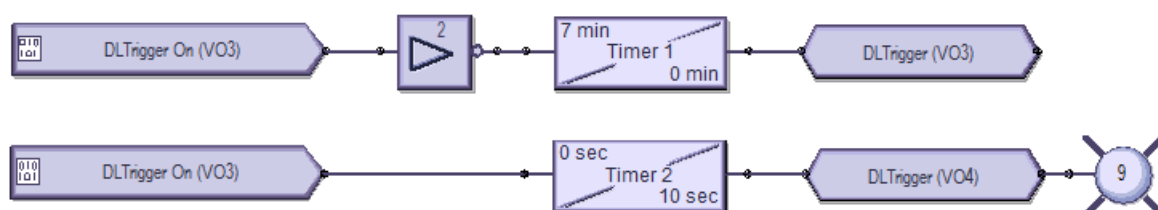
Preparation — Under **Settings > Inputs/Outputs > Virtual Outputs**, the first and second virtual outputs are named OscTrigger

Top logic — Three-minute timer trigger

Bottom logic — Turn on LED 1 for 10 seconds when the trigger starts

#### Create data logger trigger every seven minutes

Figure 4-67: Seven-minute timer turns on LED for 10 seconds



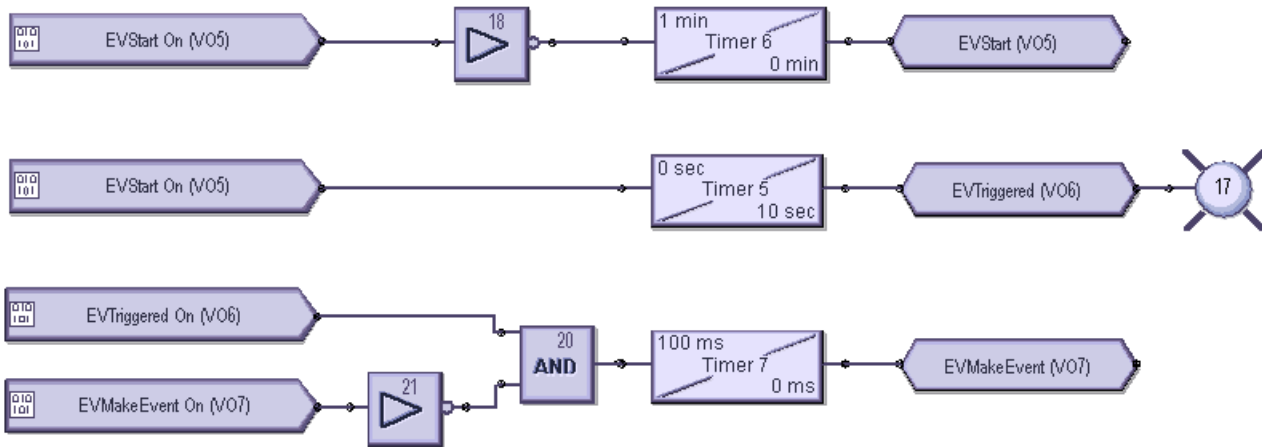
Preparation — Under **Settings > Inputs/Outputs > Virtual Outputs**, virtual outputs 3 and 4 are named DLTrigger

Top logic — Seven-minute timer trigger

Bottom logic — Turn on LED 9 for 10 seconds when the trigger starts

### Create events every minute, then every 100 ms

Figure 4-68: One-minute timer turns on LED and creates events every 100 ms



4

Preparation — Under **Settings > Inputs/Outputs > Virtual Outputs**, virtual output 5 is named EVStart, 6 is named EVTriggered, and 7 is named EVMakeEvent

Top logic — One-minute timer trigger

Middle logic — Turn on LED 17 for 10 seconds when trigger starts

Bottom logic — Create events at 100 ms intervals for the same 10 second period

#### 4.4.1.2 Add existing FlexLogic equations

A logic diagram can be created using existing FlexLogic equations (this section) or by creating new ones (next section).

When using existing equations, you modify them in the FlexLogic Equation Editor in the Offline Window area, then apply them.



The FlexLogic Equation Editor window is in view-only mode when the Logic Designer is open. To instead work in the FlexLogic Equation Editor, close the Logic Designer window, then re-open the FlexLogic Equation Editor.

To create a logic diagram using existing FlexLogic equations:

1. In the Offline Window area, modify the FlexLogic for the device under **FlexLogic > FlexLogic Equation Editor**. If the device is not listed, right-click the device in the Online Window area and select the **Add Device to Offline Window** option.  
Upon saving the modified FlexLogic, a yellow icon appears for the device in the Offline Window area to indicate that the logic differs from the Online device.
2. In the Offline Window area, access **Engineer** for the device, then **Logic Designer**. The logic opens.
3. Click the **Edit > Auto Populate Workbook** menu item. If the software prompts if you want to keep or discard existing sheets, either is acceptable, with the older excluded sheeted being denoted by brackets, such as < Sheet 1 >. The logic displays in the various tabs. The FlexLogic created in the equation editor appears in Sheet 1, for example.

#### 4.4.1.3 Create logic diagram

Upon access of the Logic Designer, the FlexLogic equations of the device display. You can create new logic in new sheets or modify the ones that display.

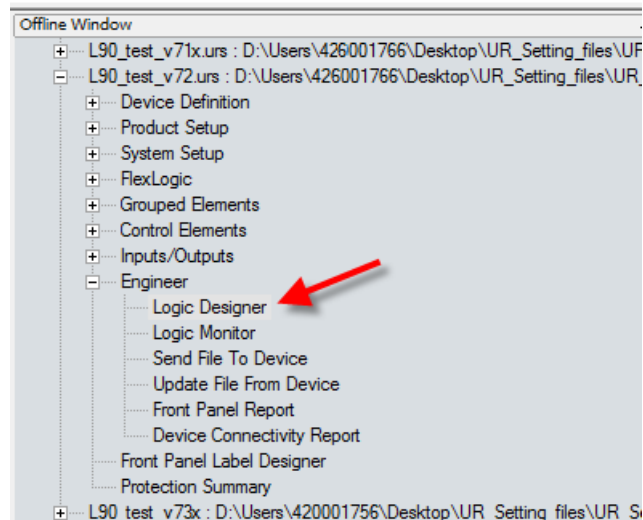
This procedure uses input / output logic as an example.

To create a logic diagram:

1. In the Offline Window area, access **Engineer** for the device, then **Logic Designer**. If the device is not listed, right-click

the device in the Online Window area and select the **Add Device to Offline Window** option.

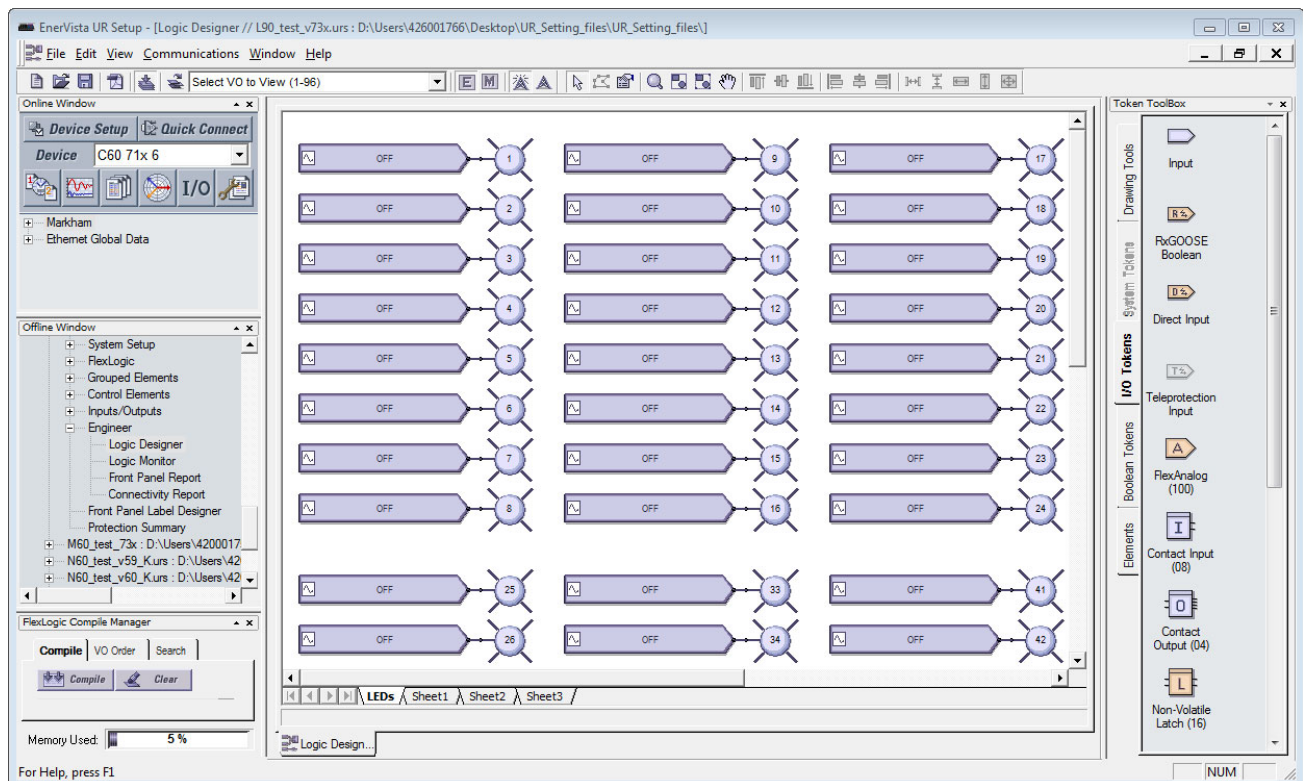
**Figure 4-69: Access Engineer in the Offline Window area**



A default block diagram opens that shows 48 inputs (boxes) and 48 user-programmable LEDs (circles).

For the graphical front panel, no LEDs can be added to the window and the LEDs are removed when opening any existing files. For these existing files with the LEDs removed, save the file without them.

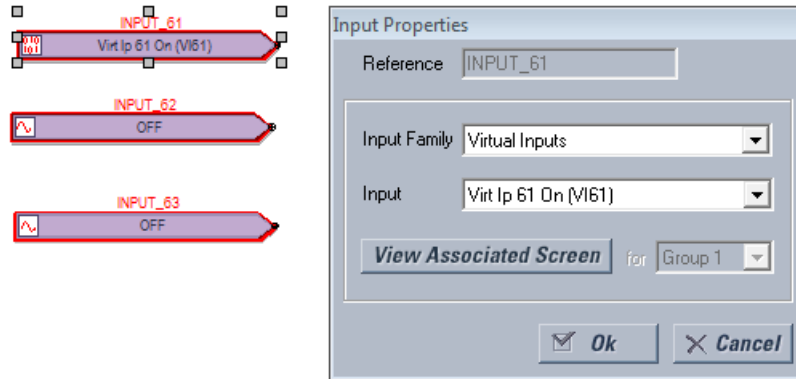
**Figure 4-70: Default view of FlexLogic designer**



2. Optionally delete the default logic diagram by right-clicking its tab at the bottom of the window and selecting **Delete**.
3. To add a blank sheet, click **Edit > Add Sheet**. A new tab displays. Or use the last tab displayed, which is a blank sheet.
4. Optionally right-click the new tab and **Rename** it.

5. Add the input blocks to the logic diagram. For example, click the **I/O Tokens** tab on the right, click the **Input** element, then click in the logic sheet to add it.
6. Double-click the block on the sheet to configure it, selecting from the two drop-down lists. The figure shows that virtual input 61 is being added. The **View Associated Screen** button opens its settings window.

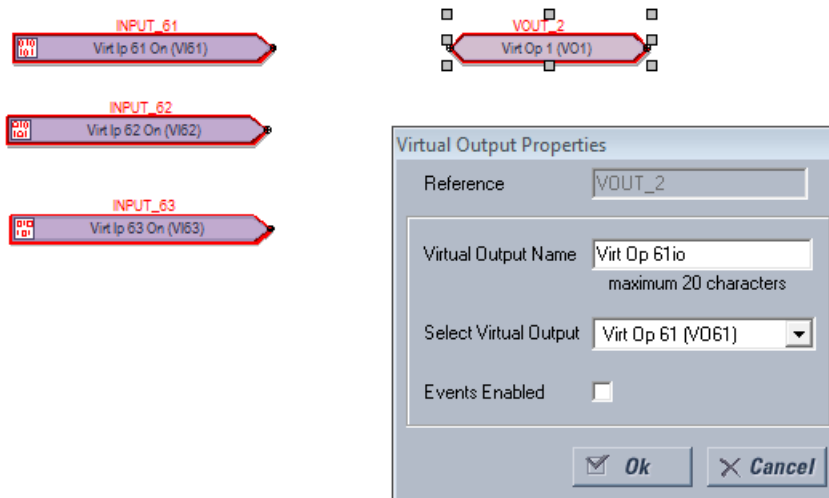
Figure 4-71: Configuring an input block



4

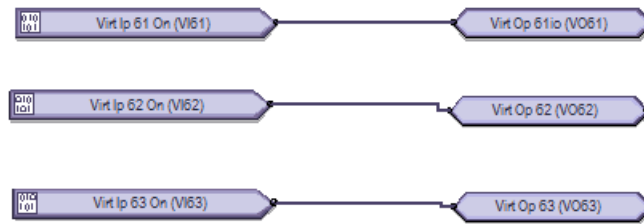
7. Add the output blocks to the logic diagram. For example, click the **I/O Tokens** tab, click the **Virtual Output** element, then click in the logic sheet to add it. Double-click the block on the sheet to configure it. For the name, make it unique. The figure shows virtual output 61 is being added, with a suffix of "io" added to the name to make it unique. Note that the outline color of a block is red until it is configured, and that this properties window varies by block and the selectable options by order code.

Figure 4-72: Configuring an output block



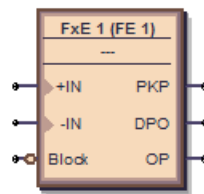
8. Connect the input blocks to the output blocks by drawing a line as follows. Click at the end of one block and drag the line to the next block. Or click the **Drawing Tools** tab, then select the **Line** option. The cursor needs to be at the connection point to end the line, not elsewhere on the block. Note that the outline color is no longer red on the blocks.

Figure 4-73: Completed inputs and outputs



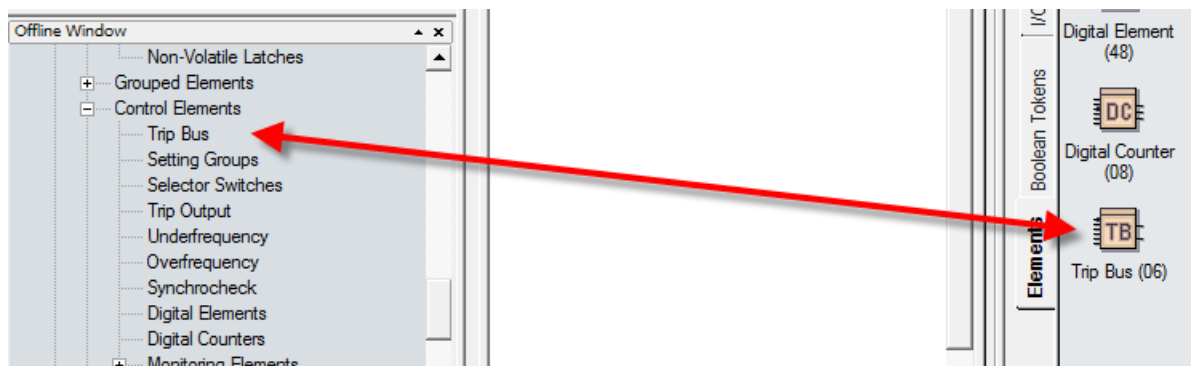
- Add any remaining blocks or information. Right-click a block to copy and paste it. Notes are as follows.  
Add a text box — Drawing Tools > Text  
Add a FlexElement — Elements > FlexElement. An analog input is expected where a small arrow head shows in the box.

Figure 4-74: FlexElement accepts analog inputs on left side where arrow heads display



Add an Element — **Elements** tab. Available elements reflect the product, for example the **Control Elements** category.

Figure 4-75: Elements reflect Control Elements



- Check for any blocks that have a red outline. These are invalid. Fix them before continuing, for example by configuring them.
- Compile the logic diagram to check for errors by clicking the **Compile** button at the bottom left or by pressing the **F7** key.

If prompted about a message about sorting, click **Yes** to apply the default (for this example), which can be automatic sorting based on an algorithm that applies fastest execution time.

With successful compiling, the file is saved and the FlexLogic equations populate automatically. Scroll up through the compile messages, with the red errors being the only messages that require fixing before proceeding.

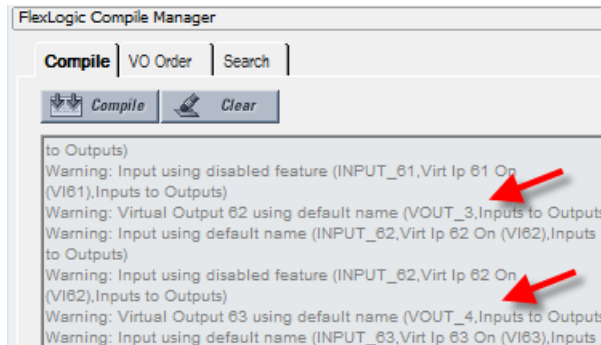
The figure shows that we forgot to add the "io" suffix to the names of virtual outputs 62 and 63, as indicated by "Warning: Virtual output xx using default name." This warning is a minor warning.

The warning "input using disabled feature" means that input needs to be enabled. Double-click the block, click the **View Associated Screen** button, enable the setting, save, and recompile.

The output and messages are explained in the next section.

Some information displayed in the compile messages updates automatically, for example messages after a device is unplugged.

Figure 4-76: Compile and check the logic



- View the FlexLogic equations by navigating in the Offline Window area to **FlexLogic > FlexLogic Equation Editor**. The window opens with the entries displayed in the next tab.

Figure 4-77: Logic displayed in FlexLogic Equation Editor

FLEXLOGIC ENTRY	TYPE	SYNTAX
View Graphic	View	View
FlexLogic Entry 1	Virtual Inputs On	Virt Ip 61 On (VI61)
FlexLogic Entry 2	Assign Virtual Output	= Virt Op 61io (VO61)
FlexLogic Entry 3	Virtual Inputs On	Virt Ip 62 On (VI62)
FlexLogic Entry 4	Assign Virtual Output	= Virt Op 62io (VO62)
FlexLogic Entry 5	Virtual Inputs On	Virt Ip 63 On (VI63)
FlexLogic Entry 6	Assign Virtual Output	= Virt Op 63io (VO63)

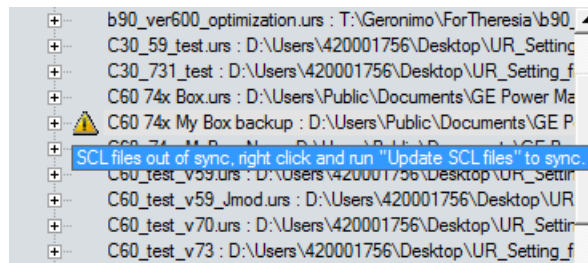
- Save the work.

The logic diagram has been created and the FlexLogic equations populated. The next steps are to upload the file to the device and to monitor the device.

#### 4.4.1.4 Compiled results and warning messages

When a yellow caution symbol displays in the Offline Window area, it means that the settings file is not synchronized with the online device. Right-click the device in the Offline Window area, and select the **Update SCL files** option. SCL refers to the Substation Configuration Language. An Instantiated IED capability description (IID) file is an example of an SCL file and contains the actual settings on a UR device.

Figure 4-78: Settings files not synchronized between offline and online files



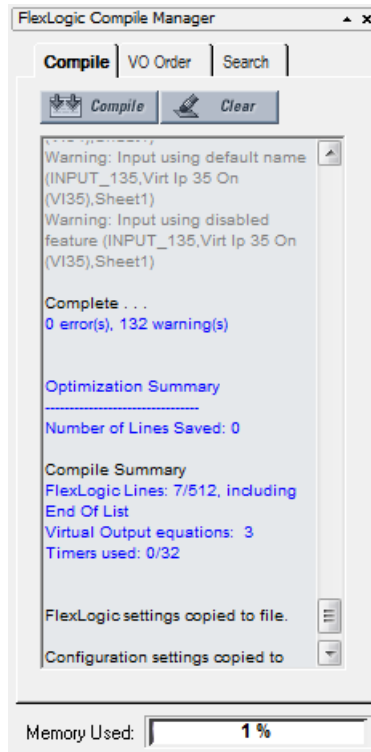
When the **Update SCL files** option is selected, the CID and IID files in the device folder are updated by the user configuration in the IEC 61850 panel and thereby become synchronized. The CID file and the IID file (depending on the preference 'Do not update IID file when updating SCL files') are updated. If the CID file is not already there, it is generated.



The location of these files is C:\ProgramData\GE Power Management\urpc, for example, in the Offline and Online folders. Any FlexLogic equations entered in the Offline Window area are erased. The logic drawn in the Logic Designer window in Engineer in the Offline Window area remain. The warning icon disappears after updating.

The following information is contained in the compile window.

Figure 4-79: Compiled results



**Number of Lines Saved** — The number of compiled logic lines eliminated by using the optimization algorithm, as set in the **Optimize Compiled Output** option of the Preferences. In the example shown, no lines were saved because the optimizer is disabled.

**FlexLogic Lines** — The number of lines that the compiled logic uses, for example seven of 512 available.

**Virtual Output equations** — The number of FlexLogic equations used in the Logic Designer window.

**Timers used** — The number of timers used in the Logic Designer window.

**Memory Used** — The percent of memory used in the Logic Designer window.

## Errors

Table 4-3: Errors from compiling

Category	Block or gate affected	Message	Description
Error	All	Number of lines (nnn) exceeds maximum limit of 512	The compiled result exceeds the limit of 512. Reduce the number of equations to 512 or less.
Error	Tag-In	Tag-in not configured (TAG_ID, SheetReference)	A Tag-In is connected to a circuit but the Tag-In is not referencing an existing Tag-Out
Error	1 Shots	One Shot is over limit (SYMBOL_ID, SheetReference)	The number of One-Shots contained within all of the VO blocks has exceeded the maximum allowed for the firmware revision. This value can either be 0 or 32.
Error	=VO	VO has no inputs (VO_ID, SheetReference)	A Virtual Output block is located within the FlexLogic diagram and there is no block connected as input to it. Connect and identify the inputs.

Category	Block or gate affected	Message	Description
Error	Timer	Timer used more than once (TIMER_ID, SheetReference)	The same timer is used in more than one place in the editor. This means either the circuit that the Timer belongs to has been branched, or the Timer has been duplicated.
Error	Input	Unrecognized Parameter (SYMBOL_ID,Name,SheetReference)	An Input symbol is configured to an item that is not recognized by the current order code and version. Possible cause: The order code and/or version of the settings file was converted causing the input parameter to become unavailable.

### Warnings

When using the 'Reset OP' operand, a warning can appear indicating that this is a disabled feature. This means that the Reset Setting's FlexLogic operand is set to OFF. Resetting of the relay can be done by pressing the reset button on the front panel of the relay or by sending a Reset command through communications.

Table 4-4: Warning messages from compiling

Category	Block or gate affected	Message	Description
Minor warning	Input	Input set to unused VO (SYMBOL_ID,Name,Sheet)	An Input symbol is using an unassigned Virtual Output
Major warning	Tag-Out	Tag-out not connected (TAG_ID,Sheet)	A Tag-Out symbol has no input
Major warning	All	Symbol not connected (SYMBOL_ID,Name,Sheet)	A symbol's input and/or output is not connected and is not part of a VO block. Draw the input and/or output to the block.
Minor warning	=VO	Virtual Output n using default name (VO_ID,Sheet)	The Assigned Virtual Output is using the default name. Change the name.
Minor warning	Input	Input using default name (SYMBOL_ID,Name,Sheet)	An Input symbol is using a Contact Input, Contact Output, Digital Element, FlexElement, or Digital Counter set to the default name. Change the name so that it is unique.
Setting warning	Input	Input using disabled feature (SYMBOL_ID,Name,Sheet)	An Input symbol is using a disabled Virtual Input, Contact Input, Digital Element, FlexElement, Digital Counter, Control Pushbutton, Programmable Pushbutton, Contact Output, or Protection/Monitoring Element. Enable it and try again.
Major warning	Input	Input set to OFF (SYMBOL_ID,Sheet)	An Input symbol is set to OFF
Major warning	Input	Input set to ON (SYMBOL_ID,Sheet)	An Input symbol is set to ON
Setting warning	Input	Contact Output Operate is OFF (SYMBOL_ID, Contacts)	The symbol block is using the default setting of OFF
Setting warning	Input	Contact Output Seal-In is OFF (SYMBOL_ID, Contacts)	The symbol block is using the default setting of OFF

#### 4.4.1.5 Rapidly add logic blocks in sequence

Blocks are added by clicking an element then clicking in the drawing area, or by dragging and dropping the element onto the canvas. Blocks can be added rapidly in sequence, for example when you have inputs 1 to 10, without having to select the element each time.

To rapidly add logic blocks:

1. In Engineer, click **File > Preferences**. The window opens.
2. Click the **Editor** entry.
3. Enable the **Repeat Symbol** check box.
4. Click the **Ok** button to save and exit from the window.
5. In the logic diagram, select an element, then click in the drawing area to add it, click again to add a second box, and so on.



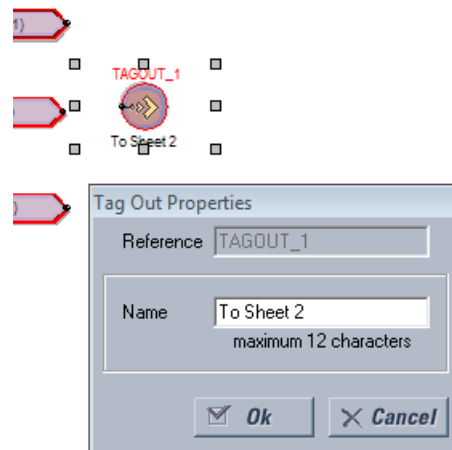
#### 4.4.1.6 Connect two logic diagrams

When the logic is complex and requires two sheets, for example, these two sheets can be connected. By connecting them, the logic is continuous from one sheet to the next.

To connect two logic diagrams:

1. In the first sheet, click the **I/O Tokens** tab.
2. Scroll to the bottom, and click and drag the **Tag Out** element to the sheet where the next sheet is to connect.
3. Double-click the element and in the window that opens, give it a name, such as "To Sheet 2" or "To IO Sheet 2."

Figure 4-80: Connecting sheet 1 to sheet 2



4. In the second sheet, click and drag the **Tag In** element to the sheet where the first sheet is to connect.
5. Double-click the element and in the window that opens, select the first sheet from the drop-down list to connect the two sheets.
6. Save the work.

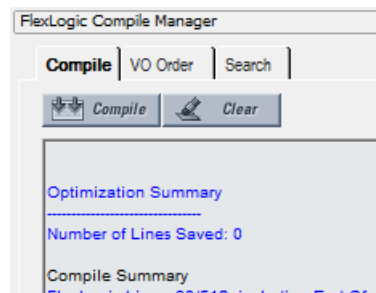
#### 4.4.1.7 Optimize the logic

The number of available FlexLogic entries depends on firmware, for example 515 or 1024 lines. The software can automatically optimize a logic diagram to reduce space and free up entries.

To optimize the logic:

1. In Engineer, under **File > Preferences**, select the **Compiler** option. Ensure that the **Optimize Compiled Output** option is enabled.
2. Run the compiler again, for example by clicking the **Compile** button at the bottom left of the software. The results display in the Optimization Summary. Changes also display when the FlexLogic Equation Editor is accessed. The logic diagram does not change. In the example shown, no lines were saved to free up space.

Figure 4-81: Code optimization results



#### 4.4.1.8 Change logic order

The order in which the FlexLogic is populated in the FlexLogic Equation Editor window depends on settings.

First, when automatic sorting is not enabled, the sequence in which the blocks were drawn is followed.

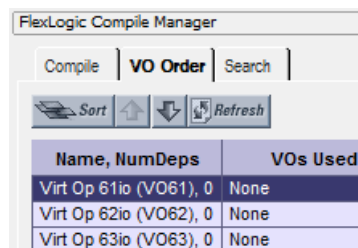
Second, the order in which equations are executed can be manually changed, as outlined here.

Third, automatic sorting can be set in preferences, as outlined here. It is enabled by default and means that an algorithm is implemented to give best results and quickest performance. For example, the block with the fastest execution time is entered first in the FlexLogic. When two block functions have the same execution time the block drawn first displays first in the FlexLogic. For example, drawing input 61 to output 61, then input 62 to output 62 causes the input/output 61 to be entered into the FlexLogic first. Automatic sorting takes precedence over manual sort; if you enable this option, manual sorting is not implemented.

To manually change logic order:

1. In the compile area, click the **VO Order** tab.
2. If the window is blank, click the **Refresh** button.
3. Select an entry and click the up or down arrow. To cancel any manual changes, click the **Sort** or **Refresh** button.
4. Recompile. The change is not executed or saved if automatic sorting is enabled.

Figure 4-82: Ordering FlexLogic entries



To set automatic sorting:

1. In Engineer, under **File > Preferences**, select the **Compiler** option. The **Automatically Sort VOs** option means that the block with the fastest execution time is entered first in the FlexLogic. When two block functions have the same execution time the block drawn first displays first in the FlexLogic. For example, drawing input 61 to output 61, then input 62 to output 62 causes the input/output 61 to be entered into the FlexLogic first.

#### 4.4.1.9 Search logic

Items that can be searched in a logic diagram include gates, Input, Contact Input, Contact Output, Timer, Virtual Output, Tag In, Tag Out, and User-programmable LED. A search can be performed while designing or monitoring.

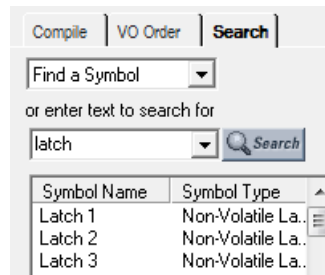
To search:

1. In the compiler area of Engineer, click the **Search** tab.
2. Use one of the following methods to set search criteria:
  - Select an element from the first drop-down list. Results display automatically.
  - Type in the second text string box, or select any of the 32 previous searches from the drop-down list. Click the **Search** button. Any results display.

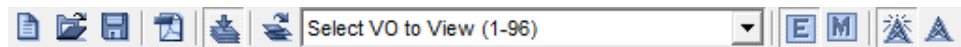
The search applies to all tabs, not just the active tab.

3. Double-click a search result to view the item.

Figure 4-83: Search function



You can also select an element from the drop-down list on the toolbar. It is then highlighted in the logic diagram.



#### 4.4.1.10 Exclude sheet from compile

While designing the FlexLogic equations, entire sheets can be removed from the compile logic. This allows the user to test various schemes by placing schemes on separate sheets and including either sheet at compile time.

To exclude a sheet:

1. In the Logic Designer window, right-click the tab and select the **Exclude from Compile** option so that the check mark displays. When sheets are excluded, a message displays with each compile that "excluded sheets will not be reflected in the RPN." An excluded sheet is denoted with end brackets, similar to < Sheet 1 >.

Figure 4-84: Excluding a tab from compiling

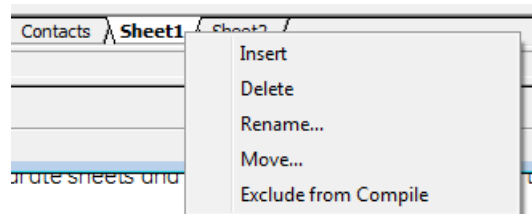
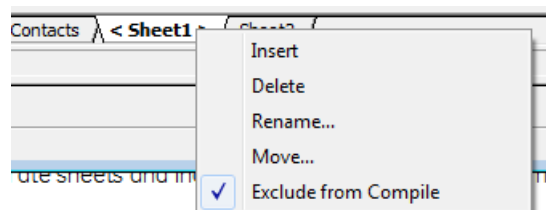


Figure 4-85: Tab excluded from compiling



#### 4.4.2 Send file to and from device

With the logic diagram created, compiled, and errors eliminated, the FlexLogic can be sent to a live device. And, conversely, a file from a live device can be added to the Offline Window area for additional work.

To send a file to a device:

1. In the Offline Window area of the software, right-click the device name and select the **Write Settings to Device** option. A prompt can appear that the URS file has been repaired; acknowledge the message.
2. When a window opens, select the device to which you want to send the file, then click the **Send** button and confirm. The order codes and IEC 61850 edition must match. The file is sent to the live device. Any errors can be viewed in the

log file at the prompt.

To import a file from a device:

1. Close all open files in Engineer that relate to the device, else a message displays to that effect, for example to close the FlexLogic view associated with the file. When the file is not associated with a live device, a message displays to that effect; you need to identify the device to which you want to send the file. The order codes must match.
2. Right-click the device in the Online Window area and select the **Add Device to Offline Window** option. After you enter a name for the file, it is written to the Offline Window area.

### 4.4.3 Monitor logic

After creating the logic diagram, validating it, and uploading the FlexLogic to a device, the results from the device can be viewed.

The following checks are performed automatically when switching from design to monitoring, and prompts display when necessary:

- Verify that the order code of the linked relay matches the settings file
- Verify that the version of the linked relay matches the settings file
- Verify that the FlexLogic Equation Editor of the linked relay matches the settings file. Solution: Compile the FlexLogic logic diagram and send the settings file to the relay.
- Verify that the FlexLogic Timers of the linked relay match the settings file. Solution: Compile the FlexLogic logic diagram and send the settings file to the relay.
- If the settings file contains a serial number lock, then verify that the serial number of the linked relay matches the settings file

To view results:

1. In the Offline Window area of the software, expand the **Engineer** entry for the device.
2. Double-click the **Logic Designer** entry and **Compile** the logic.
3. Double-click the **Logic Monitor** entry, or click the **M** button in the toolbar at the top of the window. With successful launch, the logic displays and a green indicator displays at the bottom of the tab.

When the file is not associated with a live device, a message displays to that effect; you need to identify the device to which you want to send the file. The order codes must match between the Offline Window and the Online Window.

When the device is offline, a message indicates problems communicating with the device.

When the devices are not synchronized, a message indicates the FlexLogic does not match the settings file. To send the offline file to the device, right-click the device name and select the **Write Settings to Device** option.

When the state of a symbol is OFF, the symbol is shown in the default color or no color.

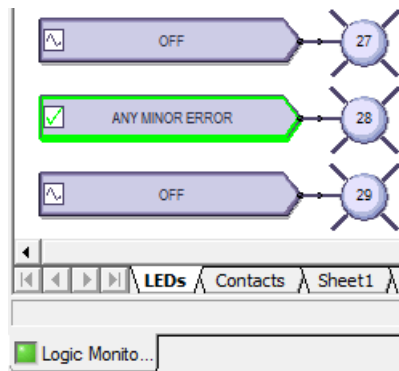
When a symbol's state changes to ON, the symbol and connection line turns green.

The state of some symbols can either be unknown or the state transitions faster than the update interval. For these two cases, the state of the symbol is considered 'UNKNOWN' and the symbol is outlined in red.

The colors for the ON and Unknown state can be customized in the Preferences.

The figure shows that the software is communicating with devices (square green indicator) and that a minor error is present (green box outline). In this case, the battery is weak and needs to be replaced. This can be viewed as the Replace Battery message on the front panel of the device and in the EnerVista software under **Actual Values > Front Panel > Front Panel** or **Display/Keypad**.

Figure 4-86: Monitoring a device, with minor error caused by weak battery



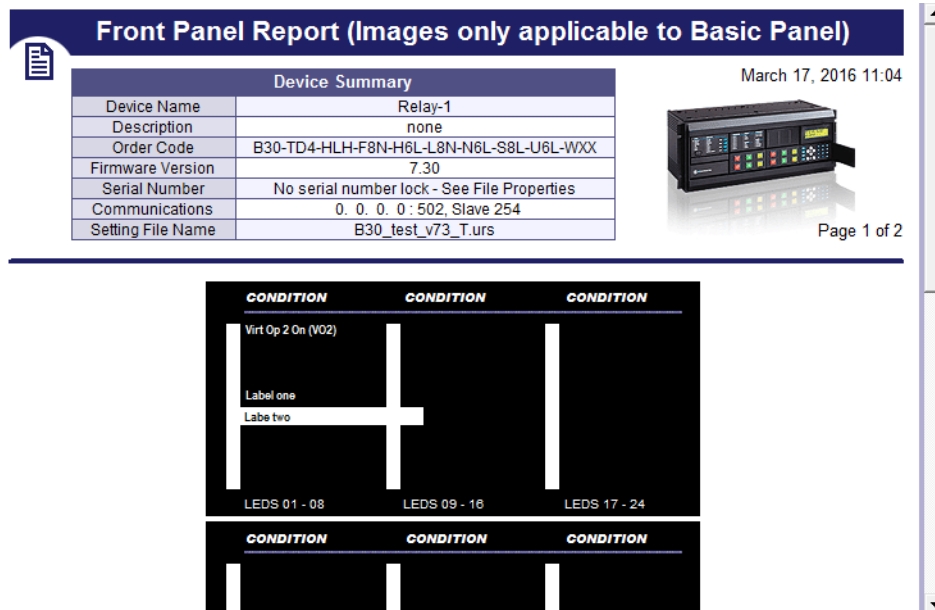
#### 4.4.4 View front panel and print labels

This window displays the LEDs that are on the front panel. You can create labels and print them for the device. You do not use the window to add text labels and upload them to the device. Custom labelling is also outlined earlier in this chapter; see the Front Panel Labelling section.

To view the front panel:

1. In the Offline Window area of the software, expand the **Engineer** entry for the device.
2. Double-click the **Front Panel Report** entry. The report displays. The Device Summary is read from the settings file and cannot be changed. The LEDs and pushbuttons display below the summary.
3. To save the report, click **File > Save As**, enter a file name, and select the front panel report (FPR), JPG, or PDF format.

Figure 4-87: Front panel display in Engineer



To print labels:

1. In the **Front Panel Report** window, double-click an LED or pushbutton and enter text.
2. To print the labels, click the **Print** icon on the toolbar.
3. To save the report and labels, click **File > Save As**, enter a file name, and select the FPR, JPG, or PDF format.
4. Use the instructions in the second tab of the window to add the labels to the physical device.

### 4.4.5 Generate connectivity report

This report displays basic information about a device, such as order code, port numbers, inputs and outputs. You can use it to create a PDF file of basic information. The report is based on CID and/or IID files, and not the system or full SCD. All device details including Remote Inputs, Remote Outputs, and Analog Inputs/Outputs are indicated, including quantities used and available.


To display a device report:

1. In the Offline Window area of the software, expand the **Engineer** entry for the device.
2. Double-click the **Device Connectivity Report** entry. The report displays.
3. To save as a PDF file, click **File > Save As**.

Figure 4-88: Device Connectivity Report

4

## Device Connectivity Report



Device Information		
Filename / Device Name	Order Code / Revision / Serial Nr.	File Details
D30_test_v73.urs Relay-1	D30-U03-HLH-F8L-H6L 7.3x No serial number lock - See File Properties	Size: 2683 KB Last Modified Date: 15.11.2016 23:29:41 Path: D:\Users\... \Desktop\JR_Setting_files\JR_Setting_files\D30_test_v73\

Device Details		
Physical Ports Available	Port Settings	Services / Protocols
RS232	RS232 Baud Rate: 115200	DNP 3.0
RS485	RS485 Baud Rate: 115200	IEC 60870-5-104
2 * 100BaseFX Eth, Multimode, SFP with LC	Port1 IP: 3. 94.244.210	IEC 61850
1 * 100BaseT Eth, Multimode, SFP with RJ-45	Port2 IP: 127. 0. 0. 1	EGD

### 4.4.6 Preferences

Preferences determine functionality. As such, you are encouraged to review them. This section outlines some options available in the menus and preference panels.

Access them in the **Logic Designer** panel under the **View** menu and under **File > Preferences**. The Logic Designer and Logic Monitor preferences are outlined here, not all preferences for a device.

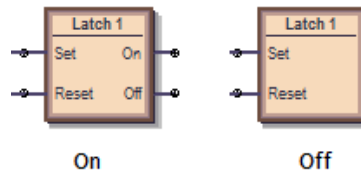
#### 4.4.6.1 View menu

**View > Toolbar > Advanced Actions** — Active when in Logic Designer. Toggles a toolbar to nudge, rotate, flip, or change the order of an element.

**View > Show Unused Pins** — Enable to display unconnected pins. Disable to eliminate unconnected pins from the view, for example when printing.



Figure 4-89: Unused pins on and off



#### 4.4.6.2 Logic designer

The path is **File > Preferences > Logic Designer**.

#### Workbook Setup

##### Size and Units

**Size and Units** — Changes the size of diagram area displayed in Engineer. If you set the size to be smaller than an existing logic diagram, the content is cut off.

##### WorkBook

**Print Scale** — The scale for logic diagram when printing. Scaling a large diagram to 200 percent, for example, results in the diagram being cut off.

**Orphan Protection** — When enabled, the printing output prevents Virtual Output circuits from spanning more than a single page. The largest Virtual Output circuit is scaled to fit on a single page and all remaining Virtual Output circuits are scaled so that all circuits are printed using the same scale.

**Show Title Block** — When enabled, places an information box at the bottom right of the diagram when printing. Enter the information in the **File Information** panel.

**Show Sheet Name** — When enabled, shows Sheet 1, Sheet 2, or any other name at the top of the logic diagram when printing.

**Start Sheet On New Page** — Places the sheet on the next page when printing.

**Show Notes Selection** — When other than None, prints the text from any information notes added to the document (under **Drawing Tools** tab > **Note**). The text is printed after the logic diagram.

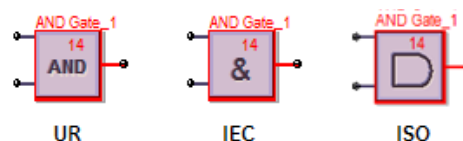
##### File Information

The text entered here displays at the bottom right of a diagram when printing, provided that the **Show Title Block** option is enabled. Note the option to change the logo from the GE logo to your company logo.

#### Display

The panel sets how the element boxes display. The figure shows how an AND gate displays when the UR default, IEC, or ISO symbol type is selected.

Figure 4-90: AND gate varies by standard selected



**Symbol Style — IEC, ISO, UR Setup** — Sets how the gates display in the logic diagram.

**Symbol Color** — When set to Black & White, only logic blocks with issues continue to display red.

**Zoom Operation** — Determines what happens when the **View > Zoom** functions are used. When set to Sheet Only and the zoom is changed, the single tab changes. When set to Workbook, all tabs change.

## Editor

**Repeat Symbol** — Enable this feature to add element blocks rapidly in sequence, for example when you have inputs 1 to 10, without having to select the element each time. Select the element block from the toolbox, click the diagram, then continue to click to add additional blocks.

**Use first available VO / Timer** — When enabled and you copy and paste a virtual output or timer element, the numbering continues in sequence. For example, you copy timer 5 and paste it as timer 6. When disabled and you copy and paste a virtual output or timer element, the same number is used. For example, you copy timer 5 and paste it as timer 5.

**Auto-Save Logic Designer every x minutes** — Logic diagrams with changes are saved automatically according to this interval. The range is 5 minutes (default) to 30 minutes. With auto-save, the file extension of the saved file is .auto. This file remains until you save the file manually.

## Auto Populate

These options work in the **Edit > Auto Populate Workbook** function.

**VOs per Worksheet** — When an existing settings file is opened in the Logic Designer, the Logic Designer populates the canvas and attempts to evenly distribute the Virtual Output circuits across multiple sheets. A value of 100 in this setting places all FlexLogic equations on a single sheet until there are 100, then the next ones are placed on another sheet. A value of 1 places each Virtual Output circuit on a separate sheet.

**Show / FlexLogic Merge / Show Unused** — If Show Contact Outputs and Show LEDs are selected, for example, the function places Contact Output and User-programmable LED symbols for settings that are configured. If you disable the LED check boxes, then the LED tab/sheet does not display when you next open the Logic Designer window. The settings apply to all products, not just the active window when it is next opened. Close then reopen the Logic Designer window for the setting to take effect.

## Compiler

**Show Warnings** — Options to filter the messages that display when logic compiles.

**Minor** — Enable to display minor errors. An example is using the default values of an element added to the diagram, such as the name of the element. An example is "Warning: Virtual output xx using default name," for which you simply click into the element to rename it.

**Major** — Enable to display major errors. Examples are an input that does not have a corresponding output, using disabled features, and failing to connect a symbol. Fix these errors.

**Setting** — Enable to display error message related to settings, such as an improperly configured setting, such as using ON or OFF.

**Automatically Sort VOs** — When enabled, the logic is compiled with an algorithm to give best results and quickest performance, for example the fastest logic first. The fastest logic displays in the FlexLogic Equation Editor output as the first entries in the table. Use sorting when virtual outputs have dependencies on other virtual outputs. This setting takes precedence over order set manually in the **VO Order** tab in the compiler. When disabled, the sequence in which the blocks were drawn is followed.

**Optimize Compiled Output** — With this option enabled, the software automatically optimizes a logic diagram to reduce space and free up FlexLogic entries. Run the compiler again, for example by clicking the **Compile** button at the bottom left of the software. The number of saved lines displays in the Optimization Summary. Changes also display when the FlexLogic Equation Editor is accessed. The logic diagram does not change.

### 4.4.6.3 Logic monitor

#### Display

The software displays the color specified when an element is on. There is no color when the element is off.

The software displays another color when the status cannot be determined and is unknown.

## Timing

Timing Information can be displayed in the monitoring window. This timing information is only an approximate representation of how Engineer sees transitions. Use the device's Event Record to view accurate timing information.

The timing information can also be streamed to a comma-separated values (CSV) spreadsheet.

The timing information displayed and recorded can be filtered based on six categories. If a category is not selected, any timing information related to that category does not display and is not recorded to the CSV file.

**Show Timing Information in Output Window** — Enable to display times in the monitoring window.

Because of the update rate of the Logic Monitoring, the timing information cannot be used as an accurate representation of the events that occur within the relay. Use instead the device's event record. Timing information can be delayed by 30 seconds.

**Save Timing Information to CSV File** — Enable to write timing information in a spreadsheet. The timing information is recorded in a text file that uses commas to separate each of the fields. This file uses the extension CSV that is supported by any spreadsheet application.

Every change written to the CSV file requires a timestamp.

The format for the timing information in the output window is as follows:

```
yyyy/mm/dd hh:dd:ss
  devicename offline
yyyy/mm/dd hh:dd:ss
  devicename ONLINE
yyyy/mm/dd hh:dd:ss
  VO1: Virt Out 1- 0
  VI4: Virt In 4- 1
  DI3: Direct In 3- 0
  RI2: Remote In 2- 1
  H5a: Contact In 1- 1
  H1: Contact Output 1- 0
```

Data is only appended to the CSV file. The format for the data is as follows:

```
yyyy/mm/dd hh:dd:ss, devicename, offline
yyyy/mm/dd hh:dd:ss, devicename, ONLINE
yyyy/mm/dd hh:dd:ss, VO1: Virt Out 1, 0
yyyy/mm/dd hh:dd:ss, VI4: Virt In 4, 1
yyyy/mm/dd hh:dd:ss, DI3: Direct In 3, 0
yyyy/mm/dd hh:dd:ss, RI2: Remote In 2, 1
yyyy/mm/dd hh:dd:ss, H5a: Contact In 1, 1
yyyy/mm/dd hh:dd:ss, H1: Contact Output 1, 0
```

Options display for filtering, such as recording timing for Virtual Inputs and Outputs, but not Communications Status.

### 4.4.6.4 COMTRADE waveforms

Waveform files are viewable in the EnerVista software. The preferences are unrelated to Engineer and are outlined in the UR Family Communications Guide.

### 4.4.7 Toolbars

These are toggled in the **View > Toolbar** menu.

The UR symbols are displayed for the toolbox icons. They change when the default setting is changed to IEC or ISO symbols. The symbols displayed in the toolbox also vary by firmware version, reflecting what is supported for each release.

#### 4.4.7.1 FlexLogic Editor toolbar











	New Device	Create a new settings file
	Open File	Open an existing settings file in the URS, CID, or IID format
	Save FlexLogic	Save the Logic Designer diagram
	PDF Report	Create a PDF document from Logic Designer diagram(s). Settings can be changed under <b>File &gt; Preferences &gt; Workbook Setup</b> .
	Toggle Compile Window	Display or hide the compile window area
	Sort Order	Select to change the sort order of the Virtual Output list to the right of the icon. Virtual Outputs can be sorted numerically in ascending and descending order based on numbers and names.
	Select VO to View (x - x)	Select a Virtual Output to locate and select it in the workbook. Each Virtual Output listed also contains the name of the sheet where the Virtual Output is located.
	Edit Mode Logic Designer	Switch to Logic Designer mode
	Monitor Mode Logic Monitor	Switch to Logic Monitor mode
	Turn On ALL Communications	Turn on all communications to all Logic Designer diagrams that are in the monitoring mode. Default upon each launch of Engineer.
	Turn Off All Communications	Turn off all communications to all Logic Designer diagrams that are in the monitoring mode. This is a legacy function for serial communication to turn off communication to devices. Turning off communication applies to the current session only. When you re-launch the EnerVista software, communication is on by default.

#### 4.4.7.2 Token Toolbox

##### Drawing Tools

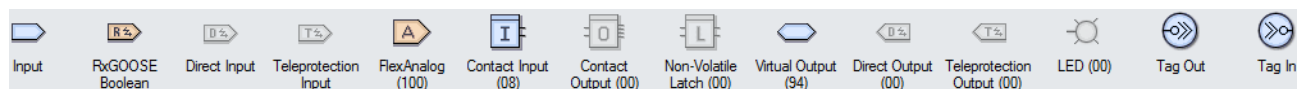






	Draw a line. Click and drag to draw.
	Draw multiple joined lines. Click and drag for each line. Double-click to finish.

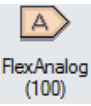
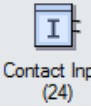
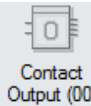
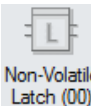

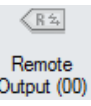
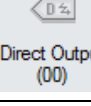
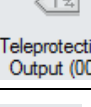
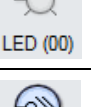

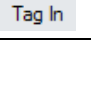
 Polygon	Draw multi-sided object. Click for each line. Double-click to finish.
 Rectangle	Draw four-sided object. Click and drag to draw.
 Polycurve	Draw multiple curves. Click for each line. Double-click to finish.
 Closed Curve	Draw multiple, closed curves. Click for each line. Double-click to finish.
 Ellipse	Draw oval or circle. Click and drag to draw.
 Text	Add text box with rectangle around it. Click to add. Double-click it to change text.
 Image	Add figure. Select file in the window that opens, then click on diagram canvas to add figure.
 Note	Add note icon and text. Click to add. Double-click to edit the title and text.

### I/O Tokens

These are parts used in FlexLogic equations. They are the inputs and outputs of the Virtual Output equations. The display can vary from that shown here.














 Input	Input symbol that can be configured to any FlexLogic operand value
 RxGOOSE Boolean	Remote inputs from other devices
 Direct Input	Input from another UR device. Teleprotection inputs/outputs and direct inputs/outputs are mutually exclusive and cannot be used simultaneously.
 Teleprotection Input	Teleprotection inputs/outputs and direct inputs/outputs are mutually exclusive and cannot be used simultaneously.

 FlexAnalog (100)	FlexAnalog symbol that can be used as the input to a FlexElement or use the FlexAnalog symbol to monitor an actual value when in logic Monitoring mode
 Contact Input (24)	Contact Input Gate is similar to the Input symbol but is restricted to the operands associated with a Contact Input
 Contact Output (00)	Contact Output Gate is similar to the Input symbol but is restricted to the operands associated with a Contact Output. The Operate and Seal-In settings can be configured graphically.
 Non-Volatile Latch (00)	The Non-Volatile Latch is similar to the Input symbol but is restricted to the operands associated with a Non-Volatile Latch. The Set and Reset settings can be configured graphically.
 Virtual Output (96)	The final output of an equation is a numbered register called a virtual output. Virtual outputs can be used as an input operand in any equation, including the equation that generates the output, as a seal-in or other type of feedback.
 Remote Output (00)	Place and configure a Remote Output. The UR's order code and firmware version then determine the availability of the Remote Output.
 Direct Output (00)	Place and configure a Direct Output. The UR's order code and firmware version then determine the availability of the Direct Output to another UR device.
 Teleprotection Output (00)	Place and configure a Teleprotection Output. The UR's order code and firmware version then determine the availability of the Teleprotection Output.
 LED (00)	Place a User Programmable LED in the Logic Designer diagram. Not applicable when using a graphical front panel.
 Tag Out	A Tag Out can be used in 1 of 2 ways. The first use of the Tag Out is to break up logic that needs to span several sheets. The second use of the Tag Out is to associate a frequently used block of code with the Tag Out and then repeatedly use the same block of code using a Tag In. When a Tag Out is referenced more than once, the Tag Out is replaced with a Virtual Output during the compile phase.
 Tag In	Tag-In can be used to reference an existing Tag-Out. It joins another diagram to a previous diagram.

### Boolean Tokens

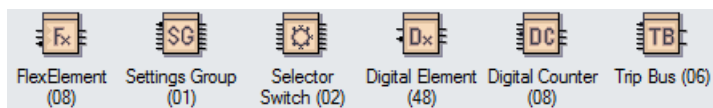
These symbols are used to create FlexLogic Equations. Use them as intermediate logic for the Virtual Output equations. The display can vary from that shown here.








 OR Gate	Place an OR gate in the Logic Designer diagram. Only one action needs to occur. Any function input on the left side satisfies the condition. The number of inputs is configurable from two to 16.
 AND Gate	Place an AND gate in the Logic Designer diagram. Multiple actions need to occur. All functions input on the left side are required to satisfy the condition. The number of inputs is configurable from two to 16.
 NOR Gate	Place a NOR gate in the Logic Designer diagram. Gives the value of one when all input operands have a value of zero and otherwise gives a value of zero. It gives an output signal when there are no input signals. An inverter that reverses the logic state. The number of inputs is configurable from two to 16.
 NAND Gate	Place a NAND gate in the Logic Designer diagram. Gives the value of zero when all input operands have a value of one and otherwise gives a value of one. It gives an output signal until all signals are present on its inputs. An inverter that reverses the logic state. The number of inputs is configurable from two to 16.
 XOR Gate	Place a XOR gate in the Logic Designer diagram, which is two exclusive OR gates. Only one action needs to occur. If there are two inputs or there is no input, there is no output.
 NOT Gate	Place a NOT gate in the Logic Designer diagram. Gives the value of one when the input operand has a value of zero and otherwise gives a value of zero. It gives an output signal when there is no input signal. An inverter that reverses the logic state.
 Latch	Place a latch in the Logic Designer diagram. A latch has two inputs and one output. One input is the Set input, and other input is the Reset input.
 Positive One Shot	Place a positive one shot symbol that responds to a positive going edge in the Logic Designer diagram. A "one shot" is a single input gate that generates a pulse ins response to an edge on the input.
 Negative One Shot	Place a negative one shot symbol that responds to a negative going edge in the Logic Designer diagram
 Dual One Shot	Place a positive one shot and a negative one shot symbol in the Logic Designer diagram
 Timer (32)	Place a timer in the Logic Designer diagram

## Elements














These blocks configure properties of the element or use element operands as input to FlexLogic equations.




 FlexElement (08)	Place and configure a FlexElement. A FlexElement is a universal comparator used to monitor any analog actual value calculated by the relay or a net difference of any two analog actual values of the same type.
 Settings Group (01)	Place and configure the Settings Group settings
 Selector Switch (02)	Place and configure a Selector Switch element. Firmware version determines feature availability. The Selector Switch element is intended to replace a mechanical selector switch. Typical applications include setting group control or control of multiple logic sub-circuits in user-programmable logic. The element provides for two control inputs.
 Digital Element (48)	Place and configure a Digital Element. A Digital Element can monitor any FlexLogic operand and present a target message and/or enable events recording depending on the output operand state.
 Digital Counter (08)	Place and configure a Digital Counter element. A Digital Counter counts the number of state transitions from Logic 0 to Logic 1. The counter is used to count operations such as the pickups of an element.

4.4.7.3 Basic Actions toolbar



	Select	Select components. Click one component and hold down the <b>CTRL</b> key to select others. Or click and drag an area that contains multiple components to select.
	Edit Vertices	Shows vertices points for the component selected (if the component support vertices manipulation)
	Properties	Shows the properties of the selected component
	Zoom Normal	Zoom in and center the screen to the spot selected
	Zoom to Fit	Zoom in to a magnitude that fits your entire schema layout on your entire screen
	Zoom Custom	Zoom in on the components that you have selected
	Pan	Move the viewable area of your screen around the schema. To activate, select this tool and then place the hand icon over and part of your schema. Click and drag the hand in a direction to move around the schema.
	Align Top, Middle, Bottom	Align the selected components to the top, middle, or bottom of the reference component
	Align Left, Center, Right	Align the selected components to the left, middle, or right of the reference component
	Space Across	Evenly space the selected components across a horizontal axis, starting from the far left component and ending at the far right component
	Space Down	Evenly space the selected components across a vertical axis, starting from the top component and ending at the bottom component
	Same Width	Set the width of the selected components to the same width as the reference component
	Same Height	Set the height of the selected components to the same height as the reference component











	Same Size	Set the width and height of the selected components to the same width and height of the reference component
---	-----------	---

#### 4.4.7.4 Advanced Actions toolbar



Only basic objects (lines, rectangles, ellipses) can be rotated and flipped.

Only objects from the Drawing Toolbar can be structured (grouped, ungrouped, forward, backward).

	Nudge Up, Down, Left, Right	Moves selected component one pixel upward, downward, left, right
	Rotate	Rotates selected component freely. Once selected, put your mouse cursor over the component and move the component clockwise or counter-clockwise depending on what you need.
	Rotate Left, Right	Rotates selected component 90 degrees counter-clockwise or clockwise
	Flip Vertical	Flips the selected component on the vertical axis
	Flip Horizontal	Flips the selected component on the horizontal axis
	Group, Ungroup	Combines all selected components into one combined entity. Ungroups them into separate components.
	Front, Back	Moves current components to the absolute front or back of all viewable layers
	Forward, Backward	Moves current components on layer higher or lower than its original layer hierarchy

4

# G30 Generator Protection System

## Chapter 5: Settings

This chapter outlines front panel and/or software settings. The relay is not taken out of service when saving settings; the relay is taken out of service when a settings file is written to it.

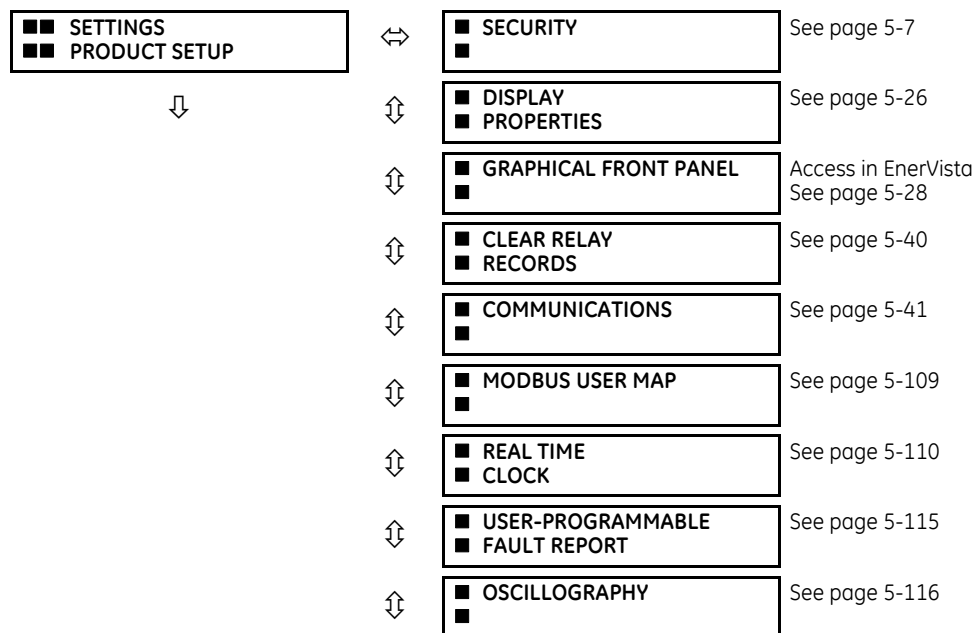
Settings can be viewed remotely in a web browser by entering the IP address of the relay, accessing the **Device Information Menu** option, then the **Front-Panel Display Report** option.

When indicated that a restart is required for a setting change to take effect, use the **Maintenance > Reboot Relay Command** in the software.

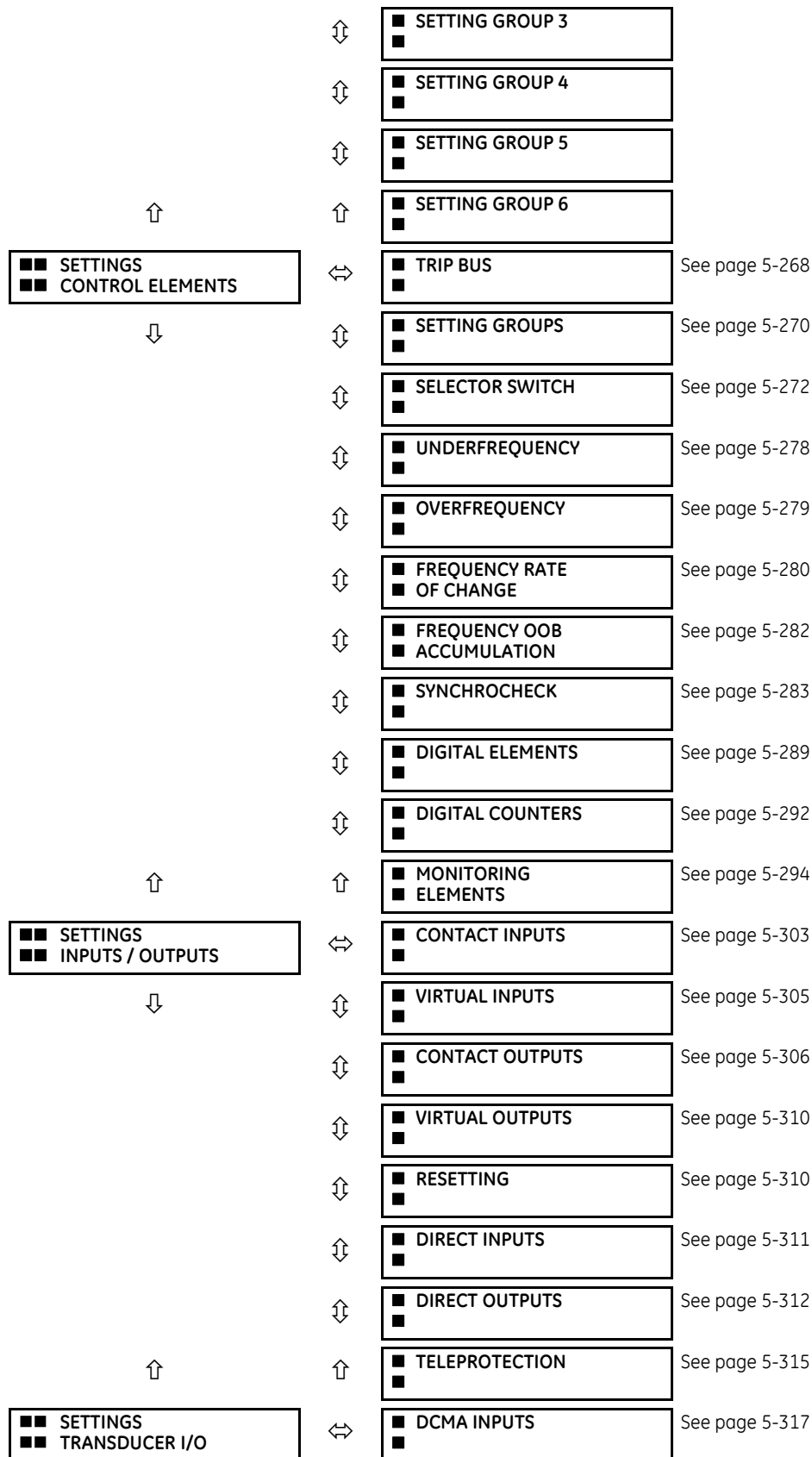
Settings file conversion from previous firmware versions is supported. See the Maintenance chapter.

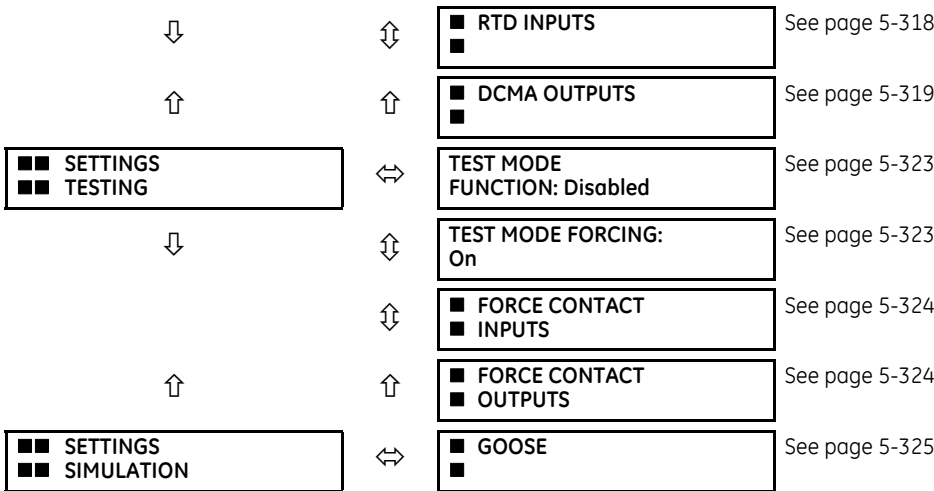
---

### 5.1 Settings menu



↑	■ ■ REMOTE RESOURCES ■ ■	⇔	■ ■ DATA LOGGER ■	See page 5-118
↓	■ ■ SETTINGS ■ ■ SYSTEM SETUP	⇔	■ ■ USER-PROGRAMMABLE ■ ■ LEDS	See page 5-120
↑		⇔	■ ■ USER-PROGRAMMABLE ■ ■ SELF TESTS	See page 5-124
↓		⇔	■ ■ CONTROL ■ ■ PUSHBUTTONS	See page 5-125
↑		⇔	■ ■ USER-PROGRAMMABLE ■ ■ PUSHBUTTONS	See page 5-126
↓		⇔	■ ■ FLEX STATE ■ ■ PARAMETERS	See page 5-132
↑		⇔	■ ■ USER-DEFINABLE ■ ■ DISPLAYS	See page 5-133
↓		⇔	■ ■ DIRECT I/O ■	See page 5-135
↑		⇔	■ ■ TELEPROTECTION ■	See page 5-141
↓		⇔	■ ■ INSTALLATION ■	See page 5-142
↑		⇔	■ ■ ■ ■	Access in EnerVista See page 5-143
↓		⇔	■ ■ AC INPUTS ■ ■	See page 5-144
↑		⇔	■ ■ POWER SYSTEM ■	See page 5-145
↓		⇔	■ ■ SIGNAL SOURCES ■	See page 5-146
↑		⇔	■ ■ TRANSFORMER ■	See page 5-149
↓		⇔	■ ■ BREAKERS ■	See page 5-160
↑		⇔	■ ■ SWITCHES ■	See page 5-165
↓		⇔	■ ■ FLEXCURVES ■	See page 5-170
↑	■ ■ SETTINGS ■ ■ FLEXLOGIC	⇔	■ ■ FLEXLOGIC ■ ■ EQUATION EDITOR	See page 5-196
↓		⇔	■ ■ FLEXLOGIC ■ ■ TIMERS	See page 5-196
↑		⇔	■ ■ FLEXELEMENTS ■	See page 5-196
↓		⇔	■ ■ NON-VOLATILE ■ ■ LATCHES	See page 5-200
↑	■ ■ SETTINGS ■ ■ GROUPED ELEMENTS	⇔	■ ■ SETTING GROUP 1 ■	See page 5-202
↓		⇔	■ ■ SETTING GROUP 2 ■	






## 5.2 Overview

### 5.2.1 Introduction to elements

For URs, the term *element* is used to describe a feature that is based around a comparator. The comparator is provided with an input (or set of inputs) that is tested against a programmed setting (or group of settings) to determine if the input is within the defined range that sets the output to logic 1, also referred to as *setting the flag*. A single comparator can make multiple tests and provide multiple outputs. For example, the time overcurrent comparator sets a pickup flag when the current input is above the setting and sets an operate flag when the input current has been at a level above the pickup setting for the time specified by the time-current curve settings. All comparators use analog actual values as the input.

 An exception to this rule is digital elements, which use logic states as inputs.

Elements are arranged into two classes, *grouped* and *control*. Each element classed as a grouped element is provided with six alternate sets of settings, in setting groups numbered 1 through 6. The performance of a grouped element is defined by the setting group that is active at a given time. The performance of a control element is independent of the selected active setting group.

The main characteristics of an element are shown on a logic diagram. This includes the inputs, settings, fixed logic, and the output operands generated. The previous chapter explains how to read a logic diagram, and the abbreviations used in a diagram are defined in the Abbreviations chapter.

Some settings are specified in per-unit (pu) calculated quantities:

$$\text{pu quantity} = (\text{actual quantity}) / (\text{base quantity})$$

Where the current source is from a single current transformer (CT), the *base quantity* is the nominal secondary or primary current of the CT. Use the secondary current base to convert per-unit settings to/from a secondary current value, and use the primary current base to convert to/from a primary current value.

Where the current source is the sum of two or more CTs with different nominal primary current, the primary base quantity is the largest nominal primary current. For example, if CT1 = 300 / 5 A and CT2 = 100 / 1 A, then in order to sum these, CT2 is scaled to the CT1 ratio. In this case, the base quantity is 300 A primary, 5 A secondary for CT1, and 300/(100/1) = 3 A secondary for CT2.

For voltage elements, the primary base quantity is the nominal phase-to-phase primary voltage of the protected system provided that the VT ratio setting is set to the nominal ratio of the VTs and the secondary voltage setting is set to the phase-to-phase voltage seen by the relay when the voltage of the protected system is nominal. The UR uses the convention that nominal voltages in a three-phase system are phase-to-phase voltages.

For example, on a system with a 13.8 kV nominal primary voltage, the base quantity is 13800 V. With 14400:120 V delta-connected VTs, the secondary base quantity and secondary voltage setting is:

$$\frac{13800}{14400} \times 120 = 115 \text{ V} \quad \text{Eq. 5-1}$$

For wye-connected VTs, the primary and secondary base quantities are as before, but the secondary voltage setting (here a phase-to-ground value) is:

$$\frac{13800}{14400} \times \frac{120}{\sqrt{3}} = 66.4 \text{ V} \quad \text{Eq. 5-2}$$

Some settings are common to many elements, outlined as follows:

- **FUNCTION setting** — This setting programs the element to operate when selected as “Enabled.” The factory default is “Disabled.” Once “Enabled,” any element associated with the function becomes active and all options become available.
- **NAME setting** — This setting is used to uniquely identify the element.
- **SOURCE setting** — This setting is used to select the AC source to be monitored. See the Introduction to AC Sources section later.
- **PICKUP setting** — For simple elements, this setting is used to program the level of the measured parameter above or below which the pickup state is established. In more complex elements, a set of settings can be provided to define the range of the measured parameters that cause the element to pick up.
- **PICKUP DELAY setting** — This setting sets a time-delay-on-pickup, or on-delay, for the duration between the pickup and operate output states.
- **RESET DELAY setting** — This setting is used to set a time-delay-on-dropout, or off-delay, for the duration between the operate output state and the return to logic 0 after the input transits outside the defined pickup range.
- **BLOCK setting** — The default output operand state of all comparators is a logic 0 or “flag not set.” The comparator remains in this default state until a logic 1 is asserted at the RUN input, allowing the test to be performed. If the RUN input changes to logic 0 at any time, the comparator returns to the default state. The RUN input is used to supervise the comparator. The BLOCK input is used as one of the inputs to RUN control.
- **TARGET setting** — This setting is used to define the operation of an element target message. When set to “Disabled,” no target message or illumination of a front panel LED indicator is issued upon operation of the element. When set to “Self-Reset,” the target message and LED indication follow the operate state of the element and self-resets once the operate element condition clears. When set to “Latched,” the target message and LED indication remains visible after the element output returns to logic 0 until a RESET command is received by the relay.
- **EVENTS setting** — This setting is used to control whether the pickup, dropout, or operate states are recorded by the event recorder. When set to “Disabled,” element pickup, dropout, or operate are not recorded as events. When set to “Enabled,” events are created for
  - <Element> PKP (pickup)
  - <Element> DPO (dropout)
  - <Element> OP (operate)

The DPO event is created when the measure and decide comparator output transits from the pickup state (logic 1) to the dropout state (logic 0). This can happen when the element is in the operate state if the reset delay time is not zero.

Not every operand of a given element in a UR relay generates events, only the major output operands. Elements, asserting output per phase, log operating phase output only, without asserting the common three-phase operand event.

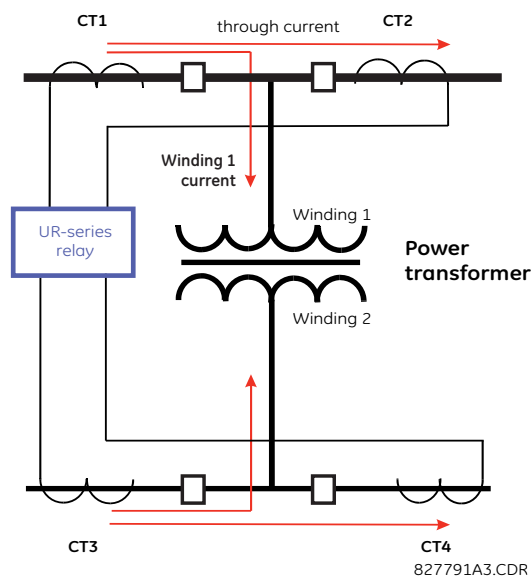
## 5.2.2 Introduction to AC sources

### 5.2.2.1 Background

A mechanism called a *source* configures the routing of CT and VT input channels to measurement sub-systems. Sources, in the context of UR series relays, refer to the logical grouping of current and voltage signals such that one source contains all the signals required to measure the load or fault in a particular power apparatus. A given source can contain all or some of the following signals: three-phase currents, single-phase ground current, three-phase voltages, and an auxiliary voltage from a single VT for checking for synchronism.

The basic idea of an AC source is to select a point on the power system where the voltages and currents are of interest. To illustrate the concept of sources, as applied to current inputs only, consider the breaker-and-a-half scheme that follows. (The breaker-and-a-half scheme is used for illustrative purposes and is available on select UR products.) In this application, the current flows as shown by the arrows. Some current flows through the upper bus bar to some other location or power equipment, and some current flows into transformer winding 1. The current into winding 1 is the phasor sum (or difference) of the currents in CT1 and CT2 (whether the sum or difference is used depends on the relative polarity of the CT connections). The same considerations apply to transformer winding 2. The protection elements require access to the net current for transformer protection, but some elements can need access to the individual currents from CT1 and CT2.

Figure 5-1: Breaker-and-a-half scheme



In conventional analog or electronic relays, the sum of the currents is obtained from an appropriate external connection of all CTs through which any portion of the current for the element being protected can flow. Auxiliary CTs are required to perform ratio matching if the ratios of the primary CTs to be summed are not identical. In the UR series of relays, provisions have been included for all the current signals to be brought to the UR device where grouping, ratio correction, and summation are applied internally via configuration settings.

A major advantage of using internal summation is that the individual currents are available to the protection device, for example as additional information to calculate a restraint current, or to allow the provision of additional protection features that operate on the individual currents, such as breaker failure.

Given the flexibility of this approach, it becomes necessary to add configuration settings to the platform to allow the user to select which sets of CT inputs are to be added to form the net current into the protected device.

The internal grouping of current and voltage signals forms an AC source. This source can be given a specific name through the settings and becomes available to protection and metering elements in the UR platform. Individual names can be given to each source to help identify them for later use. For example, in the scheme shown in the preceding figure, the user configures one source to be the sum of CT1 and CT2 and can name this source as "Wdg1 I."



Once the sources have been configured, the user has them available as selections for the choice of input signal for the protection elements and as metered quantities.

### 5.2.2.2 CT/VT module configuration

CT and voltage transformer (VT) input channels are contained in CT/VT modules. The type of input channel can be phase/neutral/other voltage, phase/ground current, or sensitive ground current. The CT/VT modules calculate total waveform RMS levels, fundamental frequency phasors, symmetrical components, and harmonics for voltage or current, as allowed by the hardware in each channel. These modules can calculate other parameters as directed by the CPU module.

A CT/VT module contains up to eight input channels, numbered 1 through 8. The channel numbering corresponds to the module terminal numbering 1 through 8 and is arranged as follows. Channels 1, 2, 3, and 4 are always provided as a group, hereafter called a “bank,” and all four are either current or voltage, as are channels 5, 6, 7, and 8. Channels 1, 2, 3 and 5, 6, 7 are arranged as phase A, B, and C respectively. Channels 4 and 8 are either another current or voltage.

Banks are ordered sequentially from the block of lower-numbered channels to the block of higher-numbered channels, and from the CT/VT module with the lowest slot position letter to the module with the highest slot position letter, as follows.

Increasing slot position letter -->		
CT/VT module 1	CT/VT module 2	CT/VT module 3
< bank 1 >	< bank 3 >	< bank 5 >
< bank 2 >	< bank 4 >	< bank 6 >

The UR platform allows for a maximum of six sets of three-phase voltages and six sets of three-phase currents. The result of these restrictions leads to the maximum number of CT/VT modules in a chassis to three. The maximum number of sources is six. A summary of CT/VT module configurations is as follows.

Item	Maximum number
CT/VT Module	2
CT Bank (3 phase channels, 1 ground channel)	4
VT Bank (3 phase channels, 1 auxiliary channel)	2

### 5.2.2.3 CT/VT input channel configuration

Upon relay startup, configuration settings for every bank of current or voltage input channels in the relay are generated automatically from the order code. Within each bank, a channel identification label is assigned automatically to each bank of channels in a given product. The *bank* naming convention is based on the physical location of the channels, required by the user to know how to connect the relay to external circuits. Bank identification consists of the letter designation of the slot in which the CT/VT module is mounted as the first character, followed by numbers indicating the channel, either 1 or 5. See the HardFiber instruction manual for designations of HardFiber voltage and current banks.

For three-phase channel sets, the number of the lowest numbered channel identifies the set. For example, F1 represents the three-phase channel set of F1/F2/F3, where F is the slot letter and 1 is the first channel of the three channels.

Upon startup, the CPU configures the settings required to characterize the current and voltage inputs, and it displays them in the appropriate section in the sequence of the banks (as described earlier) as follows for a maximum configuration: F1, F5, M1, M5, U1, and U5.

## 5.3 Product setup

### 5.3.1 Security

#### 5.3.1.1 Security overview

The following security features are available:

- Password security — Basic security present by default

- EnerVista security — Role-based access to various EnerVista software screens and configuration elements. The feature is present by default in the EnerVista software.
- CyberSentry security — Advanced security available using a software option. When purchased, the option is enabled automatically, and the default Password security and EnerVista security are disabled.

### Lost password

If all passwords are lost, recovery is possible by resetting the unit to default values. Note that the relay is reset to default values, not just the passwords.

To reset the unit after a lost password:

1. Email GE customer service at [multilin.tech@ge.com](mailto:multilin.tech@ge.com) with the serial number and using a recognizable corporate email account. Customer service provides a code to reset the relay to the factory defaults.
2. Enter the reset code on the front panel, under **COMMANDS** ⇒ **RELAY MAINTENANCE** ⇒ **SERVICE COMMAND**.
3. Change the default password of ChangeMe1# as outlined in the Set Up CyberSentry and Change Default Password section at the end of the Installation chapter.

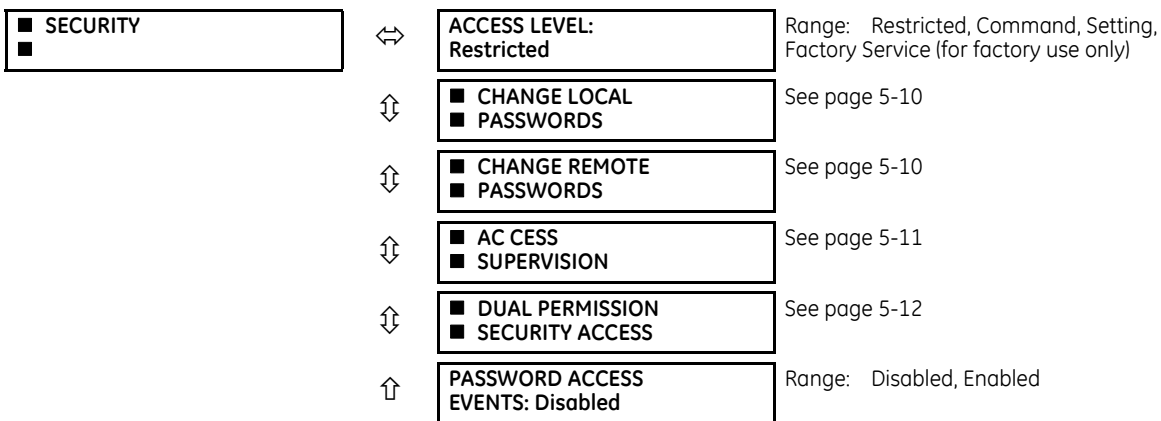
### Password requirements

A user account requires an alpha-numeric password that meets the following requirements:

- Password is case-sensitive
- Password cannot contain the user account name or parts of the user account that exceed two consecutive characters
- Password must be 8 to 20 characters in length
- Password must contain characters from all of the following categories:
  - English uppercase characters (A through Z)
  - English lowercase characters (a through z)
  - Base 10 digits (0 through 9)
  - Non-alphabetic characters (for example, ~, !, @, #, \$, %, &)

#### 5.3.1.2 Password security

SETTINGS ⇒ PRODUCT SETUP ⇒ SECURITY



The G30 supports password entry from a local or remote connection.

Local access is defined as access to settings or commands via the front panel. This includes both keypad entry and the RS232 port. Remote access is defined as access to settings or commands via any rear communications port. This includes both Ethernet and RS485 connections. Any change to the local or remote password enables this functionality.

**ACCESS LEVEL** — The "Restricted" option means that settings and commands can be accessed, but there is no access to factory configuration. Access automatically reverts to the Restricted level according to the access level timeout setting values. The access level is set to Restricted when control power is cycled.

The "Factory Service" level is not available and intended for factory use only.

There are two user security access levels, setting and command, for which you can set a password for each. Use of a password for each level controls whether users can enter commands or change settings. Another option is to specify setting and/or command access for individual user accounts.

- **Setting** — Allows the user to make any changes to any of the setting values:
  - Changing any setting
  - Test mode operation
- **Command** — Restricts the user from making any settings changes, but allows the user to perform the following operations:
  - Changing the state of virtual inputs
  - Clearing the event records
  - Clearing the oscillography records
  - Changing the date and time
  - Clearing the breaker arcing current
  - Clearing energy records
  - Clearing the data logger
  - Clearing the user-programmable pushbutton states

When entering a settings or command password via EnerVista or any serial interface, the user must enter the corresponding connection password. If the connection is to the back of the G30, the remote password must be used. If the connection is to the RS232 port of the front panel, the local password must be used.

The local setting and command sessions are initiated by the user through the front panel display and are disabled either by the user or by timeout (via the setting and command level access timeout settings). The remote setting and command sessions are initiated by the user through the EnerVista software and are disabled either by the user or by timeout.

The state of the session (local or remote, setting or command) determines the state of the following FlexLogic operands:

- **ACCESS LOC SETG OFF** — Asserted when local setting access is disabled
- **ACCESS LOC SETG ON** — Asserted when local setting access is enabled
- **ACCESS LOC CMND OFF** — Asserted when local command access is disabled
- **ACCESS LOC CMND ON** — Asserted when local command access is enabled
- **ACCESS REM SETG OFF** — Asserted when remote setting access is disabled
- **ACCESS REM SETG ON** — Asserted when remote setting access is enabled
- **ACCESS REM CMND OFF** — Asserted when remote command access is disabled
- **ACCESS REM CMND ON** — Asserted when remote command access is enabled



A command or setting write operation is required to update the state of the remote and local security operands listed.

**NOTE**

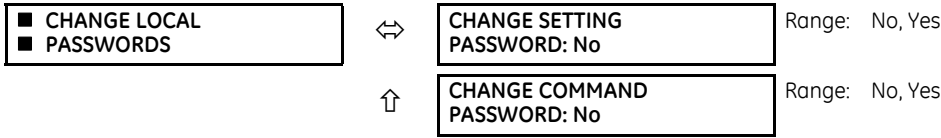
When a setting password or command password is set or updated, user access with a graphical front panel is removed. Simply log in again on the graphical front panel.

When the setting password is set or updated, the graphical front panel Access Level displays as Command. This is because the graphical front panel is a Modbus client and it does not have automatic access to the password change.

**PASSWORD ACCESS EVENTS** — This setting allows recording of password access events in the event recorder.

### Change local passwords

SETTINGS ⇒ PRODUCT SETUP ⇒ SECURITY ⇒ CHANGE LOCAL PASSWORDS




As outlined in the previous section, there are two user security access levels, setting and command. Use of a password for each level controls whether users can enter commands or change settings.

Proper password codes are required to enable each access level. When a **CHANGE COMMAND PASSWORD** or **CHANGE SETTING PASSWORD** setting is programmed to “Yes” via the front panel interface, the following message sequence is invoked:

1. ENTER NEW PASSWORD: \_\_\_\_\_.
2. VERIFY NEW PASSWORD: \_\_\_\_\_.
3. NEW PASSWORD HAS BEEN STORED.

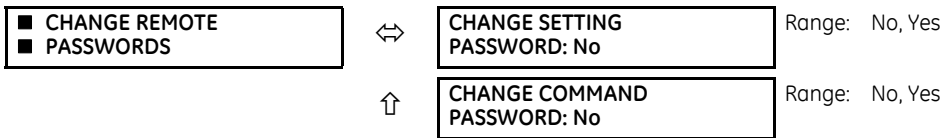
To gain write access to a “Restricted” setting, program the **ACCESS LEVEL** setting in the main security menu to “Setting” and then change the setting, or attempt to change the setting and follow the prompt to enter the programmed password. If the password is correctly entered, access is allowed. Access automatically reverts to the “Restricted” level according to the access level timeout setting values and when power is cycled.

 **NOTE** If the setting and command passwords are identical, then this one password allows access to both commands and settings.  
 If a remote connection is established, local passcodes are not visible.

### Change remote passwords

Proper passwords are required to enable each command or setting level access, which are explained in the previous section.

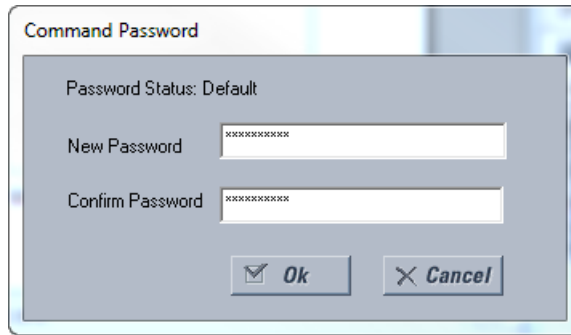
SETTINGS ⇒ PRODUCT SETUP ⇒ SECURITY ⇒ CHANGE REMOTE PASSWORDS



To set the command or setting password in EnerVista:

1. In the EnerVista software or from the front panel, navigate to **Settings > Product Setup > Security** menu item to open the remote password settings window.
2. Click the command or setting password **Change** button.
3. Enter the new password in the **New Password** field. Requirements are outlined in the Password Requirements section earlier in this chapter. When an original password has already been used, enter it in the **Enter Password** field and click the **Send Password to Device** button.
4. Re-enter the password in the **Confirm Password** field.

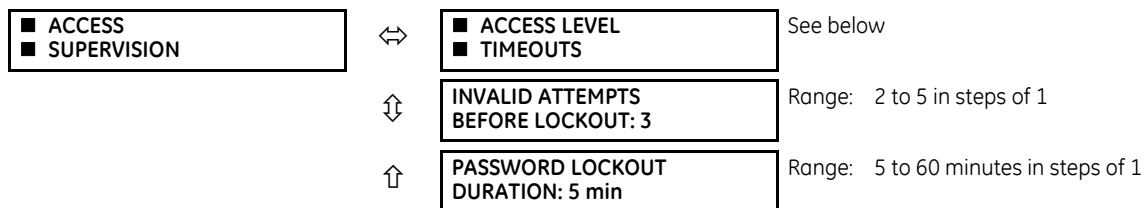
- Click the **OK** button. The password is checked to ensure that it meets requirements.



If you establish a local (serial) connection to the relay, you cannot view remote passcodes.

### Access supervision

SETTINGS ⇒ PRODUCT SETUP ⇒ SECURITY ⇒ ACCESS SUPERVISION



The following access supervision settings are available.

**INVALID ATTEMPTS BEFORE LOCKOUT** — This setting specifies the number of times that an incorrect password can be entered within a three-minute time span before lockout occurs. When lockout occurs, the [LOCAL ACCESS DENIED](#) or [REMOTE ACCESS DENIED](#) FlexLogic operands are set to “On.” These operands are returned to the “Off” state upon expiration of the lockout.

**PASSWORD LOCKOUT DURATION** — This setting specifies the time that the G30 locks out password access after the number of invalid password entries specified by the **INVALID ATTEMPTS BEFORE LOCKOUT** setting has occurred.

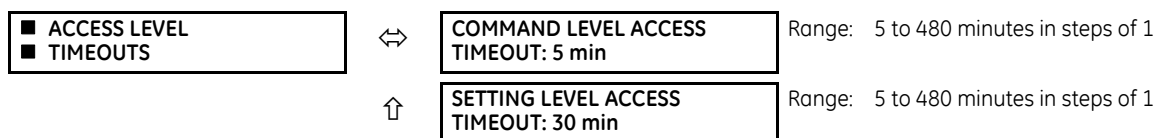
The G30 provides a means to raise an alarm upon failed password entry. If password verification fails while accessing a password-protected level of the relay (either settings or commands), the [UNAUTHORIZED ACCESS](#) FlexLogic operand is asserted. The operand can be programmed to raise an alarm via contact outputs or communications. This feature can be used to protect against both unauthorized and accidental access attempts.

The [UNAUTHORIZED ACCESS](#) operand is reset with the **COMMANDS ⇒ CLEAR RECORDS ⇒ RESET UNAUTHORIZED ALARMS** command. Therefore, to apply this feature with security, password-protect the Command level. The operand does not generate events or targets.

If events or targets are required, the [UNAUTHORIZED ACCESS](#) operand can be assigned to a digital element programmed with event logs or targets enabled.

The following table outlines access level timeout settings.

SETTINGS ⇒ PRODUCT SETUP ⇒ SECURITY ⇒ ACCESS SUPERVISION ⇒ ACCESS LEVEL TIMEOUTS



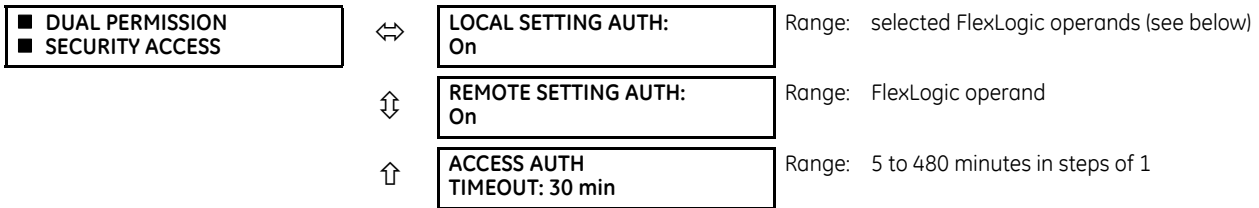
These settings allow the user to specify the length of inactivity required before returning to the Restricted access level. Note that the access level is set to Restricted when control power is cycled.

**COMMAND LEVEL ACCESS TIMEOUT** — This setting specifies the length of inactivity (no local or remote access) required to return to Restricted access from the Command password level.

**SETTING LEVEL ACCESS TIMEOUT** — This setting specifies the length of inactivity (no local or remote access) required to return to Restricted access from the Command password level.

### Dual permission security access

SETTINGS ⇒ PRODUCT SETUP ⇒ SECURITY ⇒ ↓ DUAL PERMISSION SECURITY ACCESS



This feature provides a mechanism to prevent unauthorized or unintended upload of settings to a relay through the local or remote interface.

The following settings are available through the local (front panel) interface only.

- LOCAL SETTING AUTH** — This setting is used for local (front panel or RS232 interface) setting access supervision. Valid values for the FlexLogic operands are either "On" (default) or any physical "Contact Input ~~ On" value.
 

If this setting is "On," then local setting access functions as normal; that is, a local setting password is required. If this setting is any contact input on FlexLogic operand, then the operand must be asserted (on) prior to providing the local setting password to gain setting access.

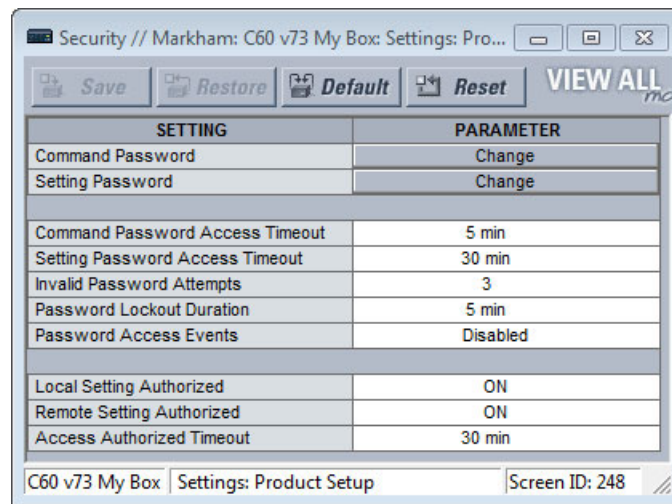
If setting access is *not* authorized for local operation (front panel or RS232 interface) and the user attempts to obtain setting access, then the UNAUTHORIZED ACCESS message displays on the front panel.

If this setting is "Off," firmware upgrades are blocked. If this setting is "On," firmware upgrades are allowed.
- REMOTE SETTING AUTH** — This setting is used for remote (Ethernet or RS485 interface) setting access supervision.
 

If this setting is "On" (the default setting), then remote setting access functions as normal; that is, a remote password is required. If this setting is "Off," then remote setting access is blocked even if the correct remote setting password is provided. If this setting is any other FlexLogic operand, then the operand must be asserted (set as on) prior to providing the remote setting password to gain setting access.

If this setting is "Off," firmware upgrades are blocked. If this setting is "On," firmware upgrades are allowed.
- ACCESS AUTH TIMEOUT** — This setting represents the timeout delay for local setting access. This setting is applicable when the **LOCAL SETTING AUTH** setting is programmed to any operand except "On." The state of the FlexLogic operand is monitored continuously for an off-to-on transition. When this occurs, local access is permitted and the timer programmed with the **ACCESS AUTH TIMEOUT** setting value is started. When this timer expires, local setting access is immediately denied. If access is permitted and an off-to-on transition of the FlexLogic operand is detected, the timeout is restarted. The status of this timer updates every five seconds.

The following settings are available through the remote (EnerVista UR Setup) interface only. Select the **Settings > Product Setup > Security** menu item to display the security settings window.



The **Remote Settings Authorized** setting is used for remote (Ethernet or RS485 interface) setting access supervision. If this setting is “On” (the default setting), then remote setting access functions as normal; that is, a remote password is required. If this setting is “Off,” then remote setting access is blocked even if the correct remote setting password is provided. If this setting is any other FlexLogic operand, then the operand must be asserted (on) prior to providing the remote setting password to gain setting access.

The **Access Authorized Timeout** setting represents the timeout delay remote setting access. It applies when the **Remote Settings Authorized** setting is programmed to any operand except “On” or “Off.” The state of the FlexLogic operand is continuously monitored for an off-to-on transition. When this occurs, remote setting access is permitted, and the timer programmed with the **Access Authorized Timeout** setting value is started. When this timer expires, remote setting access is denied immediately. If access is permitted and an off-to-on transition of the FlexLogic operand is detected, the timeout is restarted. The status of this timer updates every five seconds.

### 5.3.1.3 EnerVista security

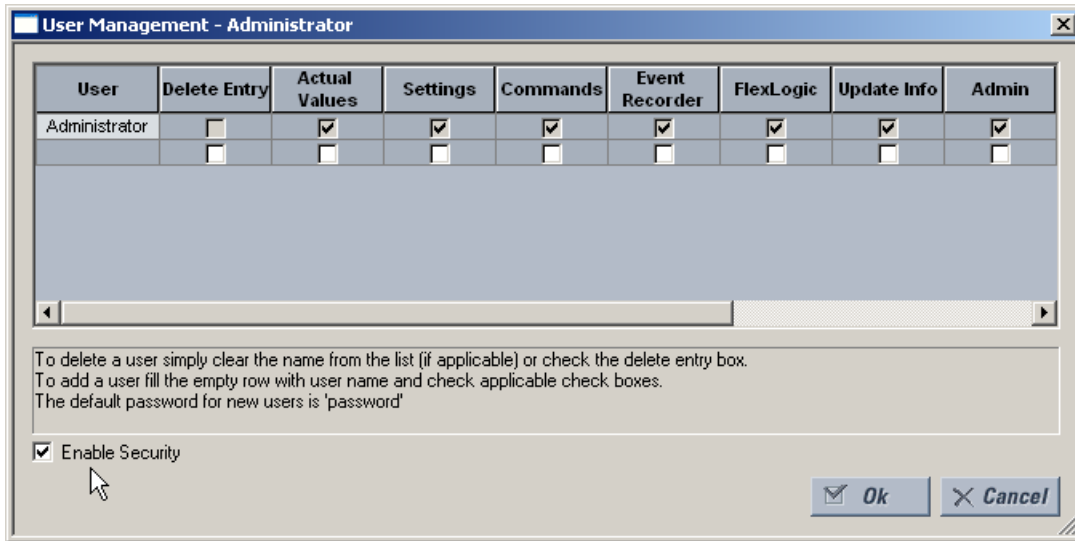
#### Enable the security management system

The EnerVista security system allows an administrator to manage access privileges of multiple users of EnerVista.

It is disabled by default to allow access to the device immediately after installation. When security is disabled, all users have administrator access. GE recommends enabling the EnerVista security before placing the device in service.

To enable the security system and require password use:

1. Select the **Security > User Management** menu to open the user management window.



2. Enable the **Enable Security** check box in the lower-left corner to enable the security management system.
3. Click the **Ok** button.

5



If you force password entry by using this feature, ensure that you know the Administrator password. If you do not know the password and are locked out of the software, contact GE Grid Solutions for the default password of a UR device. When using CyberSentry, the default password is "ChangeMe1#".

Security is now enabled for the EnerVista UR Setup software. Upon starting the software, users are now required to enter a username and password.

**Add a new user**

The following pre-requisites are required to add user accounts to the EnerVista security management system:

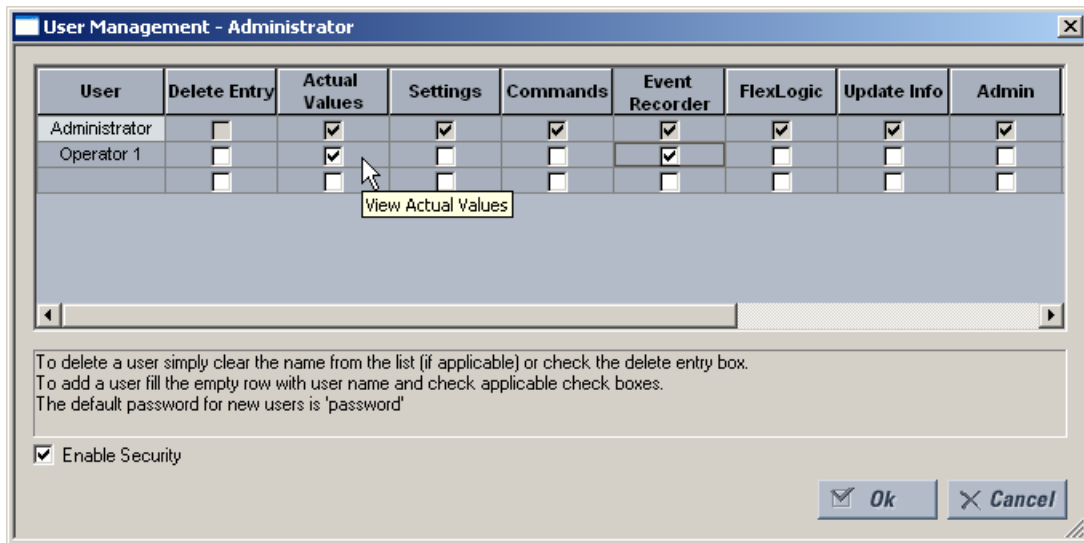
- The user adding the account must have administrator rights
- The EnerVista security management system must be enabled (previous section)

To add a user account:

1. Select the **Security > User Management** item from the top menu to open the user management window.
2. Enter a username in the **User** field. The username must be four to 20 characters in length.



3. Select the user access rights by enabling the check box of one or more fields.



The table outlines access rights.

**Table 5-1: Access rights summary**

Field	Description
Delete Entry	Deletes the user account when exiting the user management window
Actual Values	Allows the user to read <b>Actual Values</b>
Settings	Allows the user to read <b>Settings</b> values
Commands	Allows the user to execute <b>Commands</b>
Event Recorder	Allows the user to use the <b>Event Recorder</b>
FlexLogic	Allows the user to read <b>FlexLogic</b> values
Update Info	Allows the user to write to any function to which they have read privileges. When any of the <b>Settings</b> , <b>Event Recorder</b> , and <b>FlexLogic</b> check boxes are enabled by themselves, the user is granted read access. When any of them are enabled in conjunction with the <b>Update Info</b> box, they are granted read and write access. The user is not granted write access to functions that are not enabled, even if the <b>Update Info</b> field is enabled.
Admin	When the check box is enabled, the user becomes an EnerVista UR Setup administrator and has all administrative rights. Exercise caution when granting administrator rights.

4. Click **OK** to add the user account to the system.

### Modify user privileges

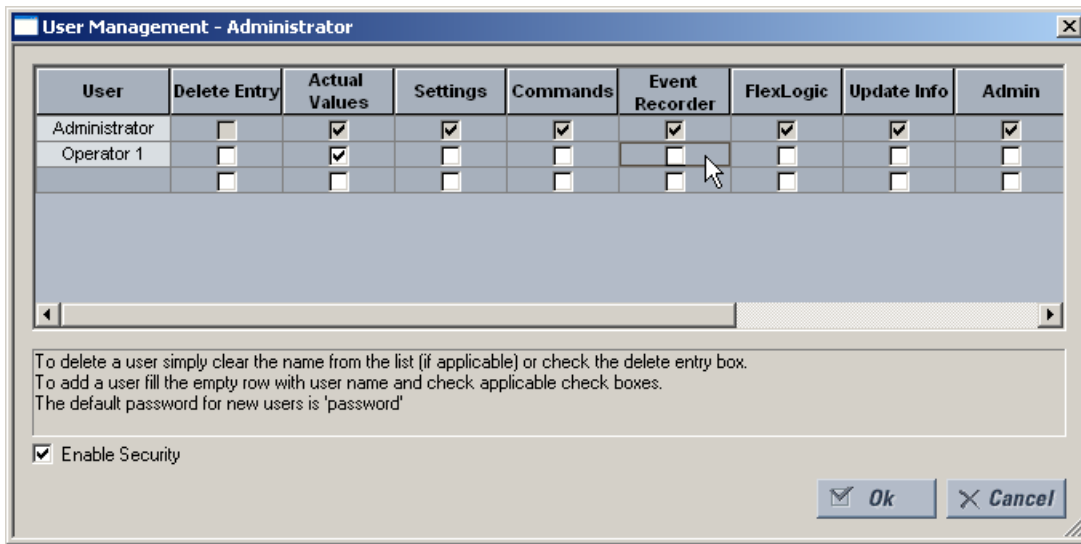
The following pre-requisites are required to modify user privileges in the EnerVista security management system:

- The user modifying the privileges must have administrator rights
- The EnerVista security management system must be enabled (the **Enable Security** check box enabled)

To modify user privileges:

1. Select the **Security > User Management** item from the top menu to open the user management window.
2. Locate the username in the **User** field.

- Modify the user access rights by enabling or disabling one or more of the check boxes.



The table outlines access rights.

**Table 5-2: Access rights summary**

Field	Description
Delete Entry	Deletes the user account when exiting the user management window
Actual Values	Allows the user to read actual values
Settings	Allows the user to read setting values
Commands	Allows the user to execute commands
Event Recorder	Allows the user to use the digital fault recorder
FlexLogic	Allows the user to read FlexLogic values
Update Info	Allows the user to write to any function to which they have read privileges. When any of the <b>Settings</b> , <b>Event Recorder</b> , and <b>FlexLogic</b> check boxes are enabled by themselves, the user is granted read access. When any of them are enabled in conjunction with the <b>Update Info</b> box, they are granted read and write access. The user is not granted write access to functions that are not enabled, even if the <b>Update Info</b> field is enabled.
Admin	When this check box is enabled, the user becomes an EnerVista UR Setup administrator and has all administrative rights. Exercise caution when granting administrator rights.

- Click **OK** to save the changes.

### 5.3.1.4 CyberSentry security

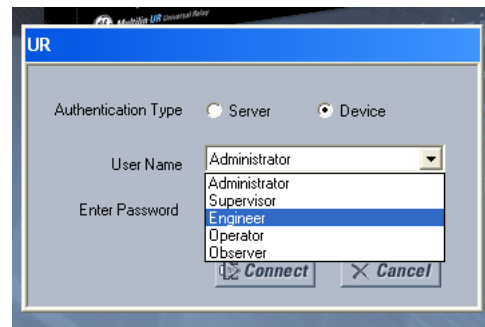


This feature requires a CyberSentry software option. See the Order Codes section in chapter 2 for details.

The EnerVista software provides the means to configure and authenticate the G30 access using either a server or the device. Access to functions depends on user role.

The login screen of EnerVista has two options for access to the G30, these being Server and Device authentication.

Figure 5-2: Login screen for CyberSentry



When the "Server" **Authentication Type** is selected, the G30 uses the RADIUS server and not its local authentication database to authenticate the user.

When the "Device" button is selected, the G30 uses its local authentication database and not the RADIUS server to authenticate the user. In this case, it uses built-in roles (Administrator, Engineer, Supervisor, Operator, Observer, or Administrator and Supervisor when Device Authentication is disabled), as login accounts and the associated passwords are stored on the G30 device. In this case, access is not user-attributable. In cases where user-attributable access is required, especially for auditable processes for compliance reasons, use server authentication (RADIUS) only.

No password or security information is displayed in plain text by the EnerVista software or the UR device, nor are they ever transmitted without cryptographic protection.



Only (TCP/UDP) ports and services that are needed for device configuration and for customer enabled features are open. All the other ports are closed. For example, Modbus is on by default, so its TCP port 502, is open. But if Modbus is disabled, port 502 is closed. This function has been tested and no unused ports have been found open.

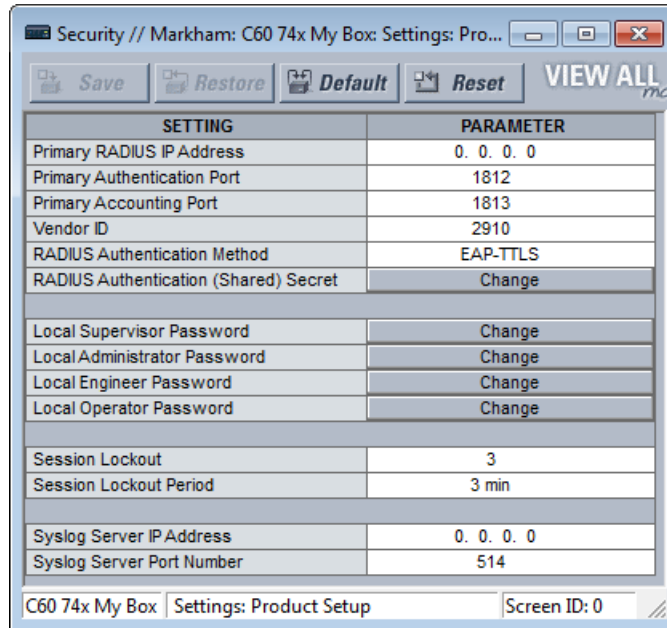
When CyberSentry is enabled, Modbus communications over Ethernet is encrypted, which is not always tolerated by SCADA systems. The UR has a bypass access feature for such situations, which allows unencrypted Modbus over Ethernet. The **Bypass Access** setting is available on the **SETTINGS ⇒ PRODUCT SETUP ⇒ SECURITY ⇒ SUPERVISORY** screen. Note that other protocols (DNP, 101, 103, 104, EGD) are not encrypted, and they are good communications options for SCADA systems when CyberSentry is enabled.

When using the rear RS485 port and CyberSentry, registers can be read with a maximum buffer of 64 bytes. Settings may not be written, so use another port or configure the **SERIAL INACTIVITY TIMEOUT** setting to a high value, such as eight minutes, to give the relay enough time to finish the task.

### CyberSentry settings through EnerVista

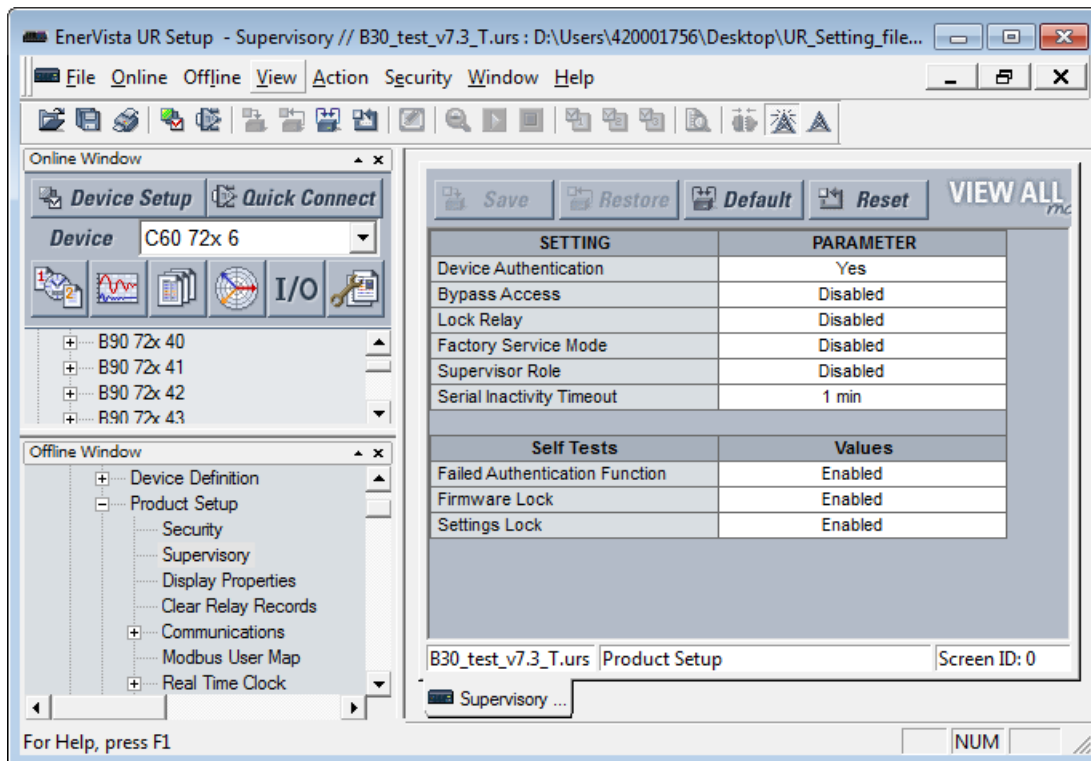
CyberSentry security settings are configured under **Device > Settings > Product Setup > Security**.

Figure 5-3: Security panel when CyberSentry installed



For the **Device > Settings > Product Setup > Supervisory** option, the panel looks like the following.

Figure 5-4: Supervisory panel



For the Security panel, the following settings are available.

Table 5-3: RADIUS server settings

Setting name	Description	Minimum	Maximum	Default	Units	Minimum permission
Primary RADIUS IP Address	IP address of the main RADIUS server. Default value indicates no Primary RADIUS server is configured, and hence RADIUS is disabled. Restart the relay for any change to take effect.	0.0.0.0	223.255.255.254	0.0.0.0	-	Administrator
Primary Authentication Port	RADIUS authentication port	1	65535	1812	-	Administrator
Primary Accounting Port	RADIUS accounting port	1	65535	1813	-	Administrator
Vendor ID	An identifier that specifies RADIUS vendor-specific attributes used with the protocol			Value that represents General Electric		Administrator
RADIUS Authentication Method	Authentication method used by RADIUS server. Can use EAP-TTLS, PEAP-GTC, or PAP. Selecting the PEAP-GTC option disables RADIUS authentication.	EAP-TTLS	PAP	EAP-TTLS	-	Administrator
RADIUS Authentication (Shared) Secret	Shared secret used in authentication. It displays as asterisks. This setting must meet the CyberSentry password requirements.	See the Password Requirements section earlier in this chapter	See the following password section for requirements	N/A	-	Administrator
Timeout	Timeout in seconds between re-transmission requests	0	9999	10	sec	Administrator
Retries	Number of retries before giving up	0	9999	3	-	Administrator
Confirm RADIUS Authentication (Shared) Secret	Confirmation of the shared secret. The entry displays as asterisks.	See the Password Requirements section	245 characters	N/A	-	Administrator

Table 5-4: General security settings

Setting name	Description	Minimum	Maximum	Default	Units	Minimum permission
Session Lockout	Number of failed authentications before the device blocks subsequent authentication attempts for the lockout period	0 (lockout disabled)	99	3	-	Administrator
Session Lockout Period	The period in minutes that a user is prevented from logging in after being locked out	0 (no period)	9999	3	min	Administrator
Syslog Server IP Address	The IP address of the target Syslog server to which all security events are transmitted	0.0.0.0	223.255.255.254	0.0.0.0	-	Administrator
Syslog Server Port Number	The UDP port number of the target syslog server to which all security events are transmitted	1	65535	514	-	Administrator
Device Authentication	When enabled, local Device authentication with roles is allowed. When disabled, the UR only authenticates to the AAA server (RADIUS). <b>NOTE:</b> Administrator and Supervisor (if still enabled) remain active even after Device authentication is disabled. The only permission for local Administrator is to re-enable Device authentication when Device authentication is disabled. To re-enable Device authentication, the Supervisor unlocks the device for setting changes, and then the Administrator can re-enable Device authentication.	Disabled	Enabled	Enabled	-	Administrator

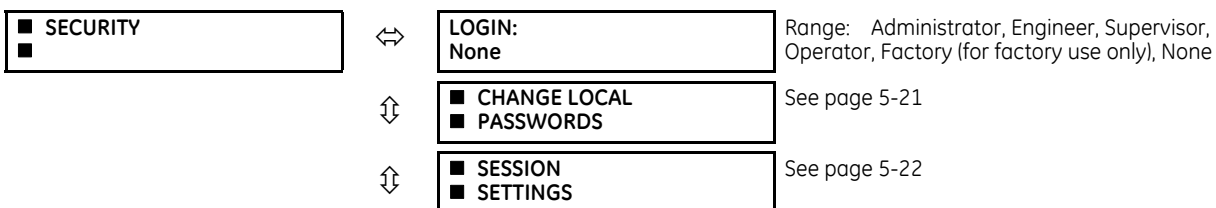
Setting name	Description	Minimum	Maximum	Default	Units	Minimum permission
Firmware Lock (via Lock Relay)	Indicates if the device receives firmware upgrades. If Enabled and the firmware upgrade attempt is made, the device denies the upgrade and displays an error message that the lock is set. On each firmware upgrade, this setting goes back to the default.  The Lock Relay setting blocks settings and firmware updates.	Disabled	Enabled	Enabled	-	Administrator
Factory Service Mode	When enabled, the device can go into factory service mode. To enable, Supervisor authentication is necessary.	Disabled	Enabled	Disabled	-	Supervisor (Administrator when Supervisor is disabled)
Restore to Defaults	Sets the device to factory defaults	No	Yes	No	-	Administrator
Supervisor Role	When enabled, the Supervisor role is active. To enable, Administrator authentication is necessary. When disabled, the Supervisor role is inactive. To disable, Supervisor authentication is necessary.	Disabled	Enabled	Enabled	-	Administrator to enable and Supervisor to disable
RADIUS user names	Ensures that RADIUS user names are not the same as local/device role names	See RADIUS server documents	See RADIUS server documents		-	Administrator
Password	Local/device roles except for Observer are password-protected. All RADIUS users are password-protected.	See the Password Requirements section earlier in this chapter	See the following password section for requirements	Change Me1#	Text	The specified role and Administrator, except for Supervisor, where it is only itself

Table 5-5: Security alarm settings

Setting name	Description / Details	Min	Max	Default	Units	Minimum permissions
Failed Authentications	A threshold number indicating when an alarm is set off to indicate too many failed authentication attempts	0 (disabled)	99	3	-	Administrator
Firmware Lock	A value indicating if the device can receive a firmware upgrade. If Enabled and a firmware upgrade attempt is made, the device alarm activates. If Disabled, the device alarm does not activate. On each firmware upgrade this setting goes back to the default.	Disabled	Enabled	Enabled	-	Administrator
Settings Lock	A value indicating if the device can accept any settings changes. If Enabled and a settings change attempt is made, the device alarm activates. If Disabled, the device alarm does not activate.	Disabled	Enabled	Enabled	-	Supervisor (Administrator if Supervisor has been disabled)

### CyberSentry settings through the front panel

SETTINGS ⇒ PRODUCT SETUP ⇒ SECURITY



↕	■ RESTORE DEFAULTS ■	See page 5-22
↕	■ SUPERVISORY ■	See page 5-22
↕	SYSLOG IP ADDRESS: 0.0.0.0	Range: 0.0.0.0, 255.255.255.255
↑	SYSLOG PORT NUMBER: 514	Range: 1 to 65535

**LOGIN** — This setting is applicable for Device authentication only. This setting allows a user to log in with a specific role, as outlined here. For the Supervisor role, enable the “Supervisor Role” setting. Log out by right-clicking the device in EnerVista and selecting the **Disconnect** option.

Whenever a new role is logged in, the user is prompted to enter a password. Passwords must obey the requirements specified earlier in the chapter in the Password Requirements section. The UR device supports five roles. Roles have their corresponding passwords, except the Observer role, which does not require a password. There are no time-outs for the Administrator, Engineer, Operator, and Supervisor when logged in using the front panel; log out manually or use the **Command > Security** commands in the software.

The roles are defined as follows:

- Administrator — Complete read/write access to all settings and commands. This role does not allow concurrent access. This role has an operand to indicate when it is logged on.
- Engineer — Complete read/write access to all settings and commands except configuring Security settings and firmware upgrades. This role does not allow concurrent access.
- Operator — The Operator has read/write access to all settings under the Commands menu/section. This role does not exist offline.
- Supervisor — This is only an approving role. This role’s authentication commits setting changes submitted by Administrator or Engineer. The Supervisor role authenticates to unlock the UR relay for setting changes and not approve changes after the fact. Only a Supervisor can set the Settings Lock and Firmware Lock in the Security settings. This role also has the ability to forcefully log off any other role and clear the security event log. This role can also be disabled, but only through a Supervisor authentication. When this role is disabled its permissions are assigned to the Administrator role.
- Observer — This role has read-only access to all G30 settings. This role allows unlimited concurrent access but it has no download access to any files on the device. Observer is the default role if no authentication has been done to the device. This role displays as “None” on the front panel. When local authentication is used, no password is required for this role. When RADIUS server authentication is used, a password is required.



The Factory service role is not available. It is for factory use only.

The Local Access Denied message on the front panel can mean that you need to log in to the UR in order to complete the action.

## Change local passwords

SETTINGS ⇒ PRODUCT SETUP ⇒ SECURITY ⇒ CHANGE LOCAL PASSWORDS

■ CHANGE LOCAL ■ PASSWORDS	↔	LOGIN: None	Range: 20 alphanumeric characters
	↕	NEW PASSWORD:	Range: 20 alphanumeric characters
	↑	CONFIRM PASSWORD:	Range: 20 alphanumeric characters

The menu is shown on the front panel upon successful login of the Administrator role.

The **LOGIN** setting in this menu is similar to that described in **SETTINGS > PRODUCT SETUP > SECURITY** except for the factory role.

Passwords are stored in text format. No encryption is applied.



In Device authentication mode, the Observer role does not have a password associated with it. In Server authentication mode the Observer role requires a password.

If you are locked out of the software, contact GE Grid Solutions for the default password. When using CyberSentry, the default password is "ChangeMe1#".

Once the passwords are set, the Administrator with Supervisor approval can change the role-associated password.

In CyberSentry, password encryption is not supported.

### Session settings

SETTINGS ⇒ PRODUCT SETUP ⇒ SECURITY ⇒ SESSION SETTINGS

<input checked="" type="checkbox"/> SESSION <input checked="" type="checkbox"/> SETTINGS	↔	SESSION LOCKOUT: 3	Range: 0 to 99
	↑	SESSION LOCKOUT PERIOD: 3 min	Range: 0 to 9999 minutes

**SESSION LOCKOUT** — This setting specifies the number of failed authentications before the device blocks subsequent authentication attempts for the lockout period. A value of zero means lockout is disabled.

**SESSION LOCKOUT PERIOD** — This setting specifies the period of time in minutes of a lockout period. A value of 0 means that there is no lockout period.

### Restore defaults

SETTINGS ⇒ PRODUCT SETUP ⇒ SECURITY ⇒ RESTORE DEFAULTS

<input checked="" type="checkbox"/> RESTORE DEFAULTS	↔	LOAD FACTORY DEFAULTS: No	Range: Yes, No
--	---	------------------------------	----------------

**LOAD FACTORY DEFAULTS** — This setting is used to reset all the settings, communication, and security passwords. An Administrator role is used to change this setting and a Supervisor role (if not disabled) approves it.

### Supervisory

SETTINGS ⇒ PRODUCT SETUP ⇒ SECURITY ⇒ SUPERVISORY

<input checked="" type="checkbox"/> SUPERVISORY	↔	DEVICE AUTHENTICATION: Yes	Range: Yes, No
	↕	BYPASS ACCESS: Disabled	Range: Local, Remote, Local and Remote, Disabled, Pushbuttons
	↕	LOCK RELAY: Disabled	Range: Enabled, Disabled
	↕	FACTORY SERVICE MODE: Disabled	Range: Enabled, Disabled
	↕	<input checked="" type="checkbox"/> SELF TESTS	See below
	↕	SUPERVISOR ROLE: Disabled	Range: Enabled, Disabled
	↑	SERIAL INACTIVITY TIMEOUT: 1 min	Range: 1 to 9999 minutes

The Supervisory menu settings are available for Supervisor role only, or if the Supervisor role is disabled then for the Administrator role only.



**DEVICE AUTHENTICATION** — This setting is enabled by default, meaning "Yes" is selected. When enabled, Device authentication with roles is enabled. When this setting is disabled, the UR only authenticates to the AAA server (RADIUS). However, the Administrator and Supervisor (when enabled) remain active even after device authentication is disabled and their only permission is to re-enable Device authentication. To re-enable Device authentication, the Supervisor unlocks the device for settings changes, then the Administrator re-enables device authentication.

**BYPASS ACCESS** — The bypass security feature provides an easier access, with no authentication and encryption for those special situations when this is considered safe. Only the Supervisor, or the Administrator when the Supervisor role is disabled, can enable this feature.

Mode	Front panel or serial (RS232, RS485)	Ethernet
Normal mode	Authentication — Role Based Access Control (RBAC) and passwords in clear	Authentication — RBAC and passwords encrypted SSH tunneling
Bypass access mode	No passwords for allowed RBAC levels	No passwords for allowed RBAC levels No SSH tunneling

The bypass options are as follows:

- Local — Bypasses authentication for push buttons, keypad, RS232, and RS485
- Remote — Bypasses authentication for Ethernet
- Local and Remote — Bypasses authentication for push buttons, keypad, RS232, RS485, and Ethernet
- Pushbuttons — Bypasses authentication for front panel push buttons only. On the graphical front panel, the authentication for side pushbuttons to control breakers and disconnects also is bypassed.

**LOCK RELAY** — This setting uses a Boolean value (Enabled/Disabled) to indicate if the device accepts settings changes and whether the device can receive a firmware upgrade. This setting can be changed by the Supervisor role, if it is enabled, or by the Administrator if the Supervisor role is disabled. The Supervisor role disables this setting for the relay to start accepting settings changes, command changes, or firmware upgrade. After all the setting changes are applied or commands executed, the Supervisor enables to lock settings changes.

**Example:** If this setting is enabled and an attempt is made to change settings or upgrade the firmware, the UR device denies the settings changes or denies upgrading the firmware. If this setting is disabled, the UR device accepts settings changes and firmware upgrade.

This role is disabled by default.

**FACTORY SERVICE MODE** — When Enabled, the device can go into factory service mode. For this setting to become enabled a Supervisor authentication is necessary. The default value is Disabled.

**SUPERVISOR ROLE** — When Enabled, the Supervisor role is active. To Disable this setting a Supervisor authentication is necessary. If disabled, the Supervisor role is not allowed to log in. In this case, the Administrator can change the settings under the Supervisory menu.

If enabled, Supervisor authentication is required to change the settings in the Supervisory menu. If the Supervisor disables their role after authentication, the Supervisor session remains valid until they switch to another role using MMI or until they end the current Supervisor session if using communications.

This role is disabled by default.

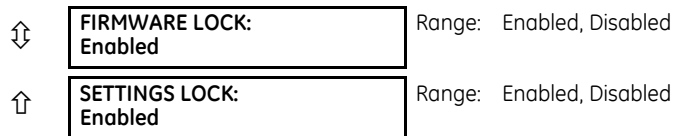
**SERIAL INACTIVITY TIMEOUT** — The role logged via a serial port is auto logged off after the Serial Inactivity timer times out. A separate timer is maintained for RS232 and RS485 connections. Set this value to a high number, such as eight minutes, when using the rear RS485 terminals for settings write.

GE recommends setting this value to at least 3 minutes for the following scenario: while connected to a CyberSentry device, with serial or USB cable connected to the front panel, and performing "Add Device to Offline Window" or an online/offline comparison. With less than the recommended 3 minutes, the serial activity timeout interrupts the connection and the security role login window appears. Upon login, the process resumes.

### Self-tests

SETTINGS ⇨ PRODUCT SETUP ⇨ SECURITY ⇨ ⬇ SUPERVISORY ⇨ SELF TESTS





**FAILED AUTHENTICATE** — If this setting is Enabled then the number of failed authentications is compared with the Session Lockout threshold. When the Session Lockout threshold is exceeded, this minor alarm indication comes up.

**FIRMWARE LOCK** — If this setting is Enabled, then any firmware upgrade operation attempt when the Lock Relay setting is enabled brings up this self test alarm.

**SETTINGS LOCK** — If this setting is Enabled then an unauthorized write attempt to a setting for a given role activates this self test.

**SETTINGS ⇒ PRODUCT SETUP ⇒ SECURITY ⇒ ↓ SUPERVISORY ⇒ SELF TESTS ⇒ FAILED AUTHENTICATE**



### CyberSentry setup

When first using CyberSentry security, use the following procedure for setup.

1. Log in to the relay as Administrator by using the **VALUE** keys on the front panel to enter the default password "ChangeMe1#". Note that the Lock Relay setting needs to be disabled in the **Security > Supervisory** menu. When this setting is disabled, configuration and firmware upgrade are possible. By default, this setting is disabled.
2. Enable the Supervisor role if you have a need for it.
3. Make any required changes in configuration, such as setting a valid IP address for communication over Ethernet.
4. Log out of the Administrator account by choosing None.
5. Next, Device or Server authentication can be chosen on the login screen, but the choice is available only in EnerVista. Use Device authentication to log in using the five pre-configured roles (Administrator, Supervisor, Engineer, Operator, Observer). When using a serial connection, only Device authentication is supported. When Server authentication is required, characteristics for communication with a RADIUS server must be configured. This is possible only in the EnerVista software. The RADIUS server itself also must be configured. The appendix called RADIUS Server at the end of this instruction manual gives an example of how to set up a simple RADIUS server. Once both the RADIUS server and the parameters for connecting the UR to the server have been configured, you can choose Server authentication on the login screen of EnerVista.

### NOTICE

The use of CyberSentry for devices communicating through an Ethernet-to-RS485 gateway is not supported. Because these gateways do not support the secure protocols necessary to communicate with such devices, the connection cannot be established. Use the device as a non-CyberSentry device.

Users logged in through the front panel are not timed out and cannot be forcefully logged out by a supervisor. Roles logged in through the front panel that do not allow multiple instances (Administrator, Supervisor, Engineer, Operator) must switch to None (equivalent to a logout) when they are done in order to log out.

For all user roles except Observer, only one instance can be logged in at a time, for both login by front panel and software.

To configure Server authentication:

1. In the EnerVista software, choose Device authentication and log in as Administrator.
2. Configure the following RADIUS server parameters: IP address, authentication port, shared secret, and vendor ID.
3. On the RADIUS server, configure the user accounts. Do not use the five pre-defined roles as user names (Administrator, Supervisor, Engineer, Operator, Observer) in the RADIUS server. If you do, the UR relay automatically provides the authentication from the device.
4. In the EnerVista software, choose Server authentication and log in using the user name and password configured on the RADIUS server for Server authentication login.

- After making any required changes, log out.

**NOTICE**

When changing settings offline, ensure that only settings permitted by the role that performs the settings download are changed because only those changes are applied.

Pushbuttons (both user-control buttons and user-programmable buttons) located on the front panel can be pressed by an Administrator or Engineer role. This also applies to the **RESET** button, which resets targets, where targets are errors displayed on the front panel or the Targets panel of the EnerVista software. The **RESET** button has special behavior in that it allows these two roles to press it even when they are logged in through the RS232 port and not through the front panel.

To reset the security event log and self-test operands:

- Log in as Supervisor (if the role is enabled) or Administrator (if the Supervisor role is disabled) and execute a clear security command under **Commands > Security > Clear Security**.

## Security events

The security events produced when the CyberSentry option is purchased are sent as system log (syslog) messages to a syslog server, if one is configured. The format is as follows.

Security log	Event Number	Date & Timestamp	Username	IP address	Role	Activity Value
--------------	--------------	------------------	----------	------------	------	----------------

**Event Number** — Event identification number (index)

**Date & Timestamp** — UTC date and time

**Username** — 255 chars maximum, but in the security log it is truncated to 20 characters

**IP address** — Device IP address

**Role** — 16 bit unsigned, of type format F617

Enumeration	Role
0	None
1	Administrator
2	Supervisor
3	Engineer
4	Operator
5	Factory

**Activity Value** — 16 bit unsigned

Enumeration	Description
1	Authentication Failed
2	User Lockout
3	FW Upgrade
4	FW Lock
5	Settings Lock
6	Settings Change. Because this can fill the entire event log, it is supported by the already existing Settings_Change.log file. This event is not required.
7	Clear Oscillography command
8	Clear Data Logger command (not applicable to all UR products)
9	Clear Demand Records command (not applicable to all UR products)
10	Clear Energy command (not applicable to all UR products)
11	Clear Unauthorized Access command
12	Clear Teleprotection Counters command (not applicable to all UR products)
13	Clear All Relay Records command
14	Role Log in

Enumeration	Description
15	Role Log off

In addition to supporting syslog, a G30 with CyberSentry also saves the security events in two local security files, these being SECURITY\_EVENTS.CSV and SETTING\_CHANGES.LOG. Details on these files and how to retrieve them are available in the EnerVista software under **Maintenance > Retrieve File**. Depending on the level of criticality/severity, a syslog server or a reporting tool gathering information from a syslog server can produce reports, charts, and so on. All severity levels are per RFC 5424.

**Table 5-6: CyberSentry system events recorded**

Event	Severity	Description
FAILED_AUTH, ORIGIN, TIMESTAMP	Notice (5)	A failed authentication with origin information (username and IP:MAC address), a time stamp in UTC time when it occurred
AUTH_LOCKOUT, ORIGIN, TIMESTAMP	Warning (4)	An authentication lockout has occurred because of too many failed authentication attempts
FIRMWARE_UPGD, ORIGIN, TIMESTAMP	Information (6)	Indicates that a change of firmware has occurred
FIRMWARE_LOCK, ORIGIN, TIMESTAMP	Warning (4)	An attempt was made to change firmware while the firmware lock was enabled
SETTING_CHG, ORIGIN, TIMESTAMP	Notice (5)	Indicates setting change(s)
SETTING_LOCK, ORIGIN, TIMESTAMP	Warning (4)	An attempt was made to change settings while the settings lock was enabled
LOGIN, ORIGIN, TIMESTAMP	Information (6)	Indicates when a certain role logged in
LOGOUT, ORIGIN, TIMESTAMP	Information (6)	Indicates when a certain role logged out or timed out
CLEAR_OSCILLOGRAPHY	Notice (5)	Clear oscillography command was issued
CLEAR_DATA_LOGGER	Notice (5)	Clear data logger command was issued
CLEAR_DEMAND_RECS	Notice (5)	Clear demand records command was issued
CLEAR_ENERGY	Notice (5)	Clear energy command was issued
RESET_UNAUTH_ACCESS	Notice (5)	Reset Unauthorized access command was issued
CLEAR_TELEPROTECTION_CNT	Notice (5)	Clear teleprotection counters command was issued
CLEAR_ALL_RECS	Notice (5)	Clear all records command was issued
WRITE_SETTING_FILE	Notice (5)	Write settings file to the relay

5

### 5.3.2 Display properties

SETTINGS ⇒ PRODUCT SETUP ⇒ DISPLAY PROPERTIES

<ul style="list-style-type: none"> <li>■ DISPLAY</li> <li>■ PROPERTIES</li> </ul>	↔	<b>LANGUAGE:</b> English	Range: English; English, French; English, Russian; English, Chinese; English, German (examples; depends on order code) Visible when language other than English purchased
	↕	<b>FLASH MESSAGE TIME:</b> 1.0 s	Range: 0.5 to 10.0 s in steps of 0.1
	↕	<b>DEFAULT MESSAGE TIMEOUT:</b> 300 s	Range: 10 to 900 s in steps of 1
	↕	<b>DEFAULT MESSAGE INTENSITY:</b> 25 %	Range: 25%, 50%, 75%, 100% Visible when a VFD is installed
	↕	<b>SCREEN SAVER FEATURE:</b> Disabled	Range: Disabled, Enabled Visible when an LCD is installed
	↕	<b>SCREEN SAVER WAIT TIME:</b> 30 min	Range: 1 to 65535 min. in steps of 1 Visible when an LCD is installed
	↕	<b>CURRENT CUT-OFF LEVEL:</b> 0.020 pu	Range: 0.002 to 0.020 pu in steps of 0.001
	↑	<b>VOLTAGE CUT-OFF LEVEL:</b> 1.0 V	Range: 0.1 to 1.0 V secondary in steps of 0.1

Some relay messaging characteristics can be modified to suit different situations using the display properties settings.

**LANGUAGE** — This setting selects the language used to display settings, actual values, and targets. This setting displays when a language other than English was purchased, and the range depends on the order code of the relay.

For Japanese, the settings display in Japanese on the graphical front panel, while the keys printed on the panel are in English.

For Japanese and Chinese, up to 10 characters can be input in a field on the graphical front panel, not 20.

With the graphical front panel, the language can be changed regardless of the language purchased. That is, all languages can be used. If you select a language with which you are unfamiliar and want to switch back to English for example, the menu order remains the same. That is, Settings is always second, Product Setup is always first, Display Properties is always second, and Language is always first.

If the language is changed after entering user-configured names, such as relay names, the strings are not translated. For example, a relay name is entered in English, the language is changed to Japanese, and the relay name remains in English. Set the language before changing settings.

The language can be selected also for the front panel in EnerVista under **Maintenance > Change Front Panel**.

The language of the EnerVista software can be changed under **View > Language**. Languages supported by the operating system display; that is for Polish or Japanese to display, the software needs to be installed on a Polish or Japanese operating system.

**FLASH MESSAGE TIME** — Flash messages are status, warning, error, and information messages displayed in response to certain key presses during settings programming. These messages override any normal messages. Use this setting to change the duration of flash messages on the display.

**DEFAULT MESSAGE TIMEOUT** — If the keypad is inactive for a period of time, the relay automatically reverts to a default message. The inactivity time is modified using this setting to ensure that messages remain on the screen long enough during programming or reading of actual values. This setting is not supported on the graphical front panel.

**DEFAULT MESSAGE INTENSITY** — To extend phosphor life in the vacuum fluorescent display, the brightness can be attenuated during default message display. During keypad interrogation, the display always operates at full brightness. This setting is not supported on the graphical front panel.

**SCREEN SAVER FEATURE** and **SCREEN SAVER WAIT TIME** — These settings are only visible if the G30 has a liquid crystal display (LCD) and control its backlighting. When the **SCREEN SAVER FEATURE** is "Enabled," the LCD backlighting turns off after the **DEFAULT MESSAGE TIMEOUT** followed by the **SCREEN SAVER WAIT TIME**, provided that no keys have been pressed and no target messages are active. When a keypress occurs or a target becomes active, the LCD backlighting turns on. These settings are not supported on the graphical front panel.

**CURRENT CUT-OFF LEVEL** — This setting modifies the current cut-off threshold. Very low currents (1 to 2% of the rated value) are very susceptible to noise. Some customers prefer very low currents to display as zero, while others prefer the current to display even when the value reflects noise rather than the actual signal. The G30 applies a cut-off value to the magnitudes and angles of the measured currents. If the magnitude is below the cut-off level, it is substituted with zero. This applies to phase and ground current phasors as well as true RMS values and symmetrical components. The cut-off operation applies to quantities used for metering, protection, and control, as well as those used by communications protocols. Note that the cut-off level for the sensitive ground input is 10 times lower than the **CURRENT CUT-OFF LEVEL** setting value. Raw current samples available via oscillography are not subject to cut-off.

**VOLTAGE CUT-OFF LEVEL** — This setting modifies the voltage cut-off threshold. Very low secondary voltage measurements (at the fractional volt level) can be affected by noise. Some customers prefer these low voltages to be displayed as zero, while others prefer the voltage to be displayed even when the value reflects noise rather than the actual signal. The G30 applies a cut-off value to the magnitudes and angles of the measured voltages. If the magnitude is below the cut-off level, it is substituted with zero. This operation applies to phase and auxiliary voltages, and symmetrical components. The cut-off operation applies to quantities used for metering, protection, and control, as well as those used by communications protocols. Raw samples of the voltages available via oscillography are not subject to cut-off.

The **CURRENT CUT-OFF LEVEL** and the **VOLTAGE CUT-OFF LEVEL** are used to determine the metered power cut-off levels. The power cut-off level is calculated using the following equations. For Delta connections:

$$\text{3-phase power cut-off} = \frac{\sqrt{3} \times \text{CURRENT CUT-OFF LEVEL} \times \text{VOLTAGE CUT-OFF LEVEL} \times \text{VT primary} \times \text{CT primary}}{\text{VT secondary}} \quad \text{Eq. 5-3}$$

For Wye connections:

$$\text{3-phase power cut-off} = \frac{3 \times \text{CURRENT CUT-OFF LEVEL} \times \text{VOLTAGE CUT-OFF LEVEL} \times \text{VT primary} \times \text{CT primary}}{\text{VT secondary}} \quad \text{Eq. 5-4}$$

$$\text{per-phase power cut-off} = \frac{\text{CURRENT CUT-OFF LEVEL} \times \text{VOLTAGE CUT-OFF LEVEL} \times \text{VT primary} \times \text{CT primary}}{\text{VT secondary}} \quad \text{Eq. 5-5}$$

where VT primary = VT secondary × VT ratio and CT primary = CT secondary × CT ratio.

For example, given the following settings:

- CURRENT CUT-OFF LEVEL:** "0.02 pu"
- VOLTAGE CUT-OFF LEVEL:** "1.0 V"
- PHASE CT PRIMARY:** "100 A"
- PHASE VT SECONDARY:** "66.4 V"
- PHASE VT RATIO:** "208.00 : 1"
- PHASE VT CONNECTION:** "Delta"

We have:

- CT primary = "100 A", and
- VT primary = **PHASE VT SECONDARY** × **PHASE VT RATIO** = 66.4 V × 208 = 13811.2 V

The power cut-off is therefore:

$$\begin{aligned} \text{power cut-off} &= (\text{CURRENT CUT-OFF LEVEL} \times \text{VOLTAGE CUT-OFF LEVEL} \times \text{CT primary} \times \text{VT primary}) / \text{VT secondary} \\ &= (\sqrt{3} \times 0.02 \text{ pu} \times 1.0 \text{ V} \times 100 \text{ A} \times 13811.2 \text{ V}) / 66.4 \text{ V} \\ &= 720.5 \text{ watts} \end{aligned}$$

Any calculated power value below this cut-off does not display. As well, the three-phase energy data do not accumulate if the total power from all three phases does not exceed the power cut-off.



Lower the **VOLTAGE CUT-OFF LEVEL** and **CURRENT CUT-OFF LEVEL** with care as the relay accepts lower signals as valid measurements. Unless dictated otherwise by a specific application, the default settings of "0.02 pu" for **CURRENT CUT-OFF LEVEL** and "1.0 V" for **VOLTAGE CUT-OFF LEVEL** are recommended.

### 5.3.3 Graphical front panel



The graphical front panel is a hardware option. See the Order Codes section in chapter 2 for details.

Use the EnerVista software to configure the graphical front panel. The settings are not accessible from the graphical front panel.

The following screens are available:

- Home page
- Rolling mode
- Metering editor
- Single-line diagram editor
- Annunciator editor
- Configurable navigation

The settings menu itself and the event record pages are not configurable.

Multiple screens can be opened in the EnerVista software, but the first remains active and the others can be read-only. For example, the Annunciator Editor and Single Line Diagram Editor can be open and active, then subsequently opened Rolling Mode and Home Page screens are read-only. Close the windows, then re-open the one required.

### 5.3.3.1 Home page

This window sets the home page displayed on the graphical front panel and the date and time formats for all pages. Home page options include display of product information, alarms, actual values, and event records.

The path is **Settings > Product Setup > Graphical Panel > Home Page**. The menu does not display when there is no graphical front panel.

Figure 5-5: Home page with product information

The screenshot shows a settings window for a relay. At the top, there are icons for 'Setting Group' (a document), 'Alarm' (a bell), and 'Target' (a crosshair). The date and time '11-May-17 12:39:59' is displayed in the top right. The main content area is divided into two columns of key-value pairs. The left column lists relay details like ID, last change, order code, serial number, firmware version, Modbus address, and port. The right column lists connection counts for MMS TCP, Modbus TCP, DNP TCP, IEC-104 TCP, and SFTP. Below this, there is a table for IP addresses and subnet masks across three ports. At the bottom, there is a 'Link Status' row and a navigation bar with buttons for 'SLDs', 'Annunciator', 'Metering', 'Event Record', and 'Menu'.

<b>Relay ID:</b>	Relay-1	<b>Remaining Connections</b>
<b>Last Setting Change:</b>	01-Jan-70 00:00:00	<b>MMS TCP:</b> 5
<b>Order Code:</b>	F60-U03-HEH-F8L-H6H	<b>Modbus TCP:</b> 4
<b>Relay Serial Number:</b>	MBEC159999#9	<b>DNP TCP:</b> 2
<b>Firmware Version:</b>	7.60	<b>IEC-104 TCP:</b> 0
<b>Modbus Slave Address:</b>	254	<b>SFTP:</b> 4
<b>Modbus TCP Port:</b>	502	
	<b>Port 1</b>	<b>Port 2</b>
<b>IP Address:</b>	192.168.2.3	10.14.22.7
<b>Subnet Mask:</b>	255.255.255.0	255.0.0.0
<b>MAC Address:</b>	00A0F4000000	00A0F4000001
<b>Link Status:</b>	Fail	OK

859850A1.cdr

Figure 5-6: Home page settings

The screenshot shows a dialog box titled 'Home Page // Markham: F60 76x My Box: Set...'. It has buttons for 'Save', 'Restore', 'Default', and 'Reset', and a 'VIEW' button. Below the buttons is a table with two columns: 'SETTING' and 'PARAMETER'. The table contains three rows: 'Home Page Content' with parameter 'Product Information', 'Date Format' with parameter 'yyyy-mm-dd', and 'Time Format' with parameter 'hh:mm:ss'. At the bottom of the dialog, it shows 'F60 76x My Box | Settings: Product Setup: Graphical F | Screen ID: 24'.

SETTING	PARAMETER
Home Page Content	Product Information
Date Format	yyyy-mm-dd
Time Format	hh:mm:ss

#### Home Page Content

*Range:* Product Information, SLD 1...5, Annunciator, Annunciator 1...8, Phasors 1...6, Tabular 1...5, Event Records, Targets  
*Default:* Product Information

This setting specifies the page to display between the home page header and footer. Pressing the **Home** button returns the display to this page. The home page displays for the rolling mode delay specified, then changes to the rolling mode pages.

The "Annunciator" option without a page number specifies the first annunciator page in the following sequence:

- The first annunciator page that contains an annunciator window that is in alarm (fast flash)



- The first annunciator page that contains an annunciator window that is in ringback. Ringback is a "return alert." Visual and audible signals are given when conditions return to normal, then the sequence returns to normal by pushing the **RESET** button.
- The first annunciator page that contains an annunciator window that is in abnormal state
- Annunciator page 1

Whenever an annunciator window changes state this list is re-evaluated, which can result in the home page displaying a different annunciator page.

The Tabular option displays a configured actual values/metering page.

The Targets option displays error messages, such as wrong transceiver, similar to event record entries.

#### Date Format

*Range: yyyy-mm-dd, dd-mmm-yy, yyyy/mm/dd, m/d/yyyy, m/d/yy, mm/dd/yy, mm/dd/yyyy, yy/mm/dd*

*Default: yyyy-mm-dd*

This setting specifies the format for dates on the graphical front panel. It applies to the page header, the events records, the annunciator, and everywhere else a date displays on the panel. If the relay is synchronized to an external time source via PTP, IRIG-B, SNTP, and so on, the date/time is shown in white, and otherwise in yellow.

yyyy — four-digit year, for example 2017

yy — two-digit year, for example 17 for 2017

mmm — abbreviation of month name, for example Jan for January

mm — two-digit month, for example 01 for January

m — one or two-digit month, for example 1 for January and 10 for October

dd — two-digit day, for example 08

d — one or two-digit day, for example 8 and 28

To set the date and time, access **Synchronize Devices** in the software, synchronize to a time source using **Settings > Product Setup > Real Time Clock**, or synchronize to the computer using **Commands > Set Date and Time**.

#### Time Format

*Range: hh:mm:ss, h:mm:ss tt*

*Default: hh:mm:ss*

This setting specifies the format for time on the graphical front panel. It applies to the page header and everywhere else a time displays on the panel. When the Date Format and the Time Format use the defaults, the date and time are separated by the character "T" per the ISO convention, such as "2017-09-24T10:58:31". Otherwise the date and time are separated by a space. If the relay is synchronized to an external time source via PTP, IRIG-B, SNTP, and so on, the date/time is shown in white, and otherwise in yellow.

hh — two-digit hour, for example 02 for two o'clock

h — one or two-digit hour, for example 2 for two o'clock

mm — two-digit minute, for example 51 minutes

ss — two-digit second (can have a decimal and further digits appended), for example 16 seconds

tt — AM or PM based on 12 hour clock

If microseconds have to be displayed, for example, in the event records, the 24-hour clock is adopted. The representation of an accumulated period (for example hh:mm) is not affected by the selected time format.

To set the date and time, access **Synchronize Devices** in the software or synchronize to a time source using **Settings > Product Setup > Real Time Clock**.

#### 5.3.3.2 Rolling mode

After a user-defined period of inactivity, the graphical front panel changes, or rolls, to user-selected pages. Up to 10 pages can be specified. Similarly, the display backlight intensity is lowered to a specified level; lower intensity extends the life of the display.

Each rolling page displays for a few seconds; duration cannot be set.

The path is **Settings > Product Setup > Graphical Panel > Rolling Mode**.



Figure 5-7: Rolling mode settings

SETTING	PARAMETER
Rolling Mode Delay	900 s
Automatic Annunciator Recall	Enabled
Screen Saver Delay	800 s
Screen Saver Intensity	30 %
Number of Rolling Mode Pages	5
Rolling Mode Page 1	Product Information
Rolling Mode Page 2	SLD 1
Rolling Mode Page 3	SLD 2
Rolling Mode Page 4	SLD 3
Rolling Mode Page 5	Event Records
Rolling Mode Page 6	Product Information
Rolling Mode Page 7	Product Information
Rolling Mode Page 8	Product Information
Rolling Mode Page 9	Product Information
Rolling Mode Page 10	Product Information

F60 76x My Box | Settings: Product Setup: Graphical F | Screen ID: 24

### Rolling Mode Delay

Range: 0 to 900 s in steps of 1

Default: 300 s

Set this delay to 0 to disable the rolling mode feature.

Otherwise, after no pushbutton has been pressed for the amount of time specified by this setting, the display automatically enters rolling mode. While in the rolling mode, the Rolling Mode Pages display. Rolling mode can be interrupted when a setting changes, such as changing the home page, then resumes rolling.

### Automatic Annunciator Recall

Range: Enabled, Disabled

Default: Enabled

When Enabled, an annunciator window changes state, and the display is in rolling mode, this setting terminates rolling mode and displays the annunciator page containing the changed state.

The Configurable Navigation feature takes precedence over this setting when the Automatic Annunciator Recall and Configurable Navigation are activated by the same input.

### Screen Saver Delay

Range: 0 to 900 s in steps of 1

Default: 300 s

The screen saver mode extends the life of the display. After the amount of time set here, the screen saver activates and the display intensity is reduced to the level set by the **Screen Saver Intensity** setting. When in rolling mode, rolling continues while the screen saver is active. The screen saver terminates when rolling mode terminates. To disable the screen saver, set the delay to 0.

### Screen Saver Intensity

Range: 0, 10, 20, or 30 %

Default: 30 %

This setting sets the brightness of the display while the screen saver is active. For example, 0% means that the screen is dark and nothing displays. Pressing a pushbutton or changing a setting in the software, for example, re-activates the display.

### Number of Rolling Mode Pages

Range: 1 to 10 in steps of 1

Default: 1

This setting specifies the number of rolling pages. During rolling mode, the graphical front panel displays pages from 1 to the selected number.

### Rolling Mode Page 1 to 10

*Range: Product Information, SLD 1...5, Annunciator, Annunciator 1...8, Phasors 1...6, Tabular 1...5, Event Records, Targets*  
*Default: Product Information*

These settings specify the pages to display on the graphical front panel while in rolling mode.

The "Annunciator" selection without a page number specifies the first annunciator page in the following sequence:

- The first annunciator page that contains an annunciator window that is in alarm (fast flash)
- The first annunciator page that contains an annunciator window that is in ringback. Ringback is a "return alert." Visual and audible signals are given when conditions return to normal, then the sequence returns to normal by pushing the **RESET** button.
- The first annunciator page that contains an annunciator window that is in abnormal state
- Annunciator page 1

Whenever an annunciator window changes state the list is re-evaluated, which can result in the display of a different annunciator page in the rolling sequence.

The Tabular option displays a configured actual values/metering page.

The Targets option displays error messages, such as wrong transceiver, similar to event record entries.

#### 5.3.3.3 Metering editor

This feature creates tables of actual/metered values for the graphical front panel. It configures the content that displays in the Metering Tab pushbutton. An actual value, status, or text can be displayed. Five tabular metering pages can be configured. There also can be a phasor page for each configured AC source, and these pages are not configurable.

The path is **Settings > Product Setup > Graphical Panel > Metering Editor**.

Set the Current Page, Page Name, Layout, configure the top inputs, then the cells. The 16 inputs at the top of the page are used as inputs for the **Status Index** fields. Click the **Preview** button to view the page.

For a phasor diagram, configure the source under **Settings > System Setup > Signal Sources**. The diagram is then viewable by pushing the **Metering** Tab pushbutton on the graphical front panel. The Metering Editor is not used for these phasor diagrams.

The figures show setup and table preview.

The Cells configured are not retained when using the **Convert Device Settings** function, for example when converting a file in the Offline Window from version 7.6 to 7.7.

Figure 5-8: Metering Editor window

STATUS		STATUS INPUTS			
1 to 4:	87L DIFF OP	87L DIFF OP G	87L DIFF BLOCKED	OFF	
5 to 8:	PH DIST Z1 OP	GND DIST Z1 OP	PH DIST Z2 OP	GND DIST Z2 OP	
9 to 12:	PH DIST Z3 OP	GND DIST Z3 OP	OFF	OFF	
13 to 16:	OFF	OFF	OFF	OFF	

CURRENT PAGE	Page 1	PAGE NAME	87L DIFF	LAYOUT	6x4	Preview		
PARAMETER	CONTENT	STATUS INDEX	TEXT	OFF TEXT	FONT	TEXT COLOR	BACK COLOR	ACTUAL
Cell(1, 1)	Text	Select One	DIFF OPERANDS		20	<span style="color: green;">█</span>		Configure
Cell(1, 2)	Status	1	87L DIFF OP	87LP NOT OP	16	<span style="color: red;">█</span>		Configure
Cell(1, 3)	Status	2	87L DIFF OP G	87LG NOT OP	16	<span style="color: red;">█</span>		Configure
Cell(1, 4)	Status	3	87L BLOCKED	87L NOT BLK	16	<span style="color: red;">█</span>		Configure
Cell(2, 1)	Text	Select One	DIFF CURRENT		20	<span style="color: blue;">█</span>		Configure
Cell(2, 2)	Actual	Select One			16	<span style="color: black;">█</span>		Configure
Cell(2, 3)	Actual	Select One			16	<span style="color: black;">█</span>		Configure
Cell(2, 4)	Actual	Select One			16	<span style="color: black;">█</span>		Configure
Cell(3, 1)	Text	Select One	RESTRAINT CURR		20	<span style="color: blue;">█</span>		Configure
Cell(3, 2)	Actual	Select One			16	<span style="color: black;">█</span>		Configure
Cell(3, 3)	Actual	Select One			16	<span style="color: black;">█</span>		Configure
Cell(3, 4)	Actual	Select One			16	<span style="color: black;">█</span>		Configure
Cell(4, 1)	Text	Select One	LOCAL CURRENT		20	<span style="color: blue;">█</span>		Configure
Cell(4, 2)	Actual	Select One			16	<span style="color: black;">█</span>		Configure
Cell(4, 3)	Actual	Select One			16	<span style="color: black;">█</span>		Configure
Cell(4, 4)	Actual	Select One			16	<span style="color: black;">█</span>		Configure
Cell(5, 1)	Text	Select One	REM CURRENT		20	<span style="color: blue;">█</span>		Configure
Cell(5, 2)	Actual	Select One			16	<span style="color: black;">█</span>		Configure
Cell(5, 3)	Actual	Select One			16	<span style="color: black;">█</span>		Configure
Cell(5, 4)	Actual	Select One			16	<span style="color: black;">█</span>		Configure
Cell(6, 1)	Text	Select One	GND DIFF		20	<span style="color: blue;">█</span>		Configure
Cell(6, 2)	Actual	Select One			16	<span style="color: black;">█</span>		Configure
Cell(6, 3)	Text	Select One	GND RESTRAINT		20	<span style="color: blue;">█</span>		Configure
Cell(6, 4)	Actual	Select One			16	<span style="color: black;">█</span>		Configure

Figure 5-9: Preview for graphical front panel

//Metering/87L DIFF			
DIFF OPERANDS	87L DIFF OP	87L DIFF OP G	87L BLOCKED
DIFF CURRENT	000000.000 A	000000.000 A	000000.000 A
RESTRAINT CURR	000000.000 A	000000.000	000000.000 A
LOCAL CURRENT	000000.000 A	000000.000 A	000000.000 A
REM CURRENT	000000.000 A	000000.000 A	000000.000 A
GND DIFF	000000.000 A	GND RESTRAINT	000000.000 A

Page 1: 87L DIFF Rows: 6 Columns: 4

**STATUS INPUTS 1 to 16**

Range: OFF, ON, any FlexLogic operand

Default: OFF

This setting identifies the potential inputs for use in the STATUS INDEX fields, for display of the status of FlexLogic operands.

A maximum of eight Status Inputs can be used per metering page, and 16 in all metering pages.

Select the metering input from the drop-down list. The options reflect the FlexLogic operands applicable to the G30. They are inputs for all five metering pages, not just the current page.

**CURRENT PAGE***Range: Page 1...Page 5**Default: Page 1*

Select the metering page to configure from the drop-down list. There are five pages possible, viewable with the Tab pushbuttons on the graphical front panel.

**PAGE NAME***Range: Page 1...Page 5**Default: Page 1*

Up to 20 characters can be input here as the name of each metering page. The name displays for the Tab pushbutton on the graphical front panel.

**LAYOUT***Range: 3x4, 4x6, 6x8, 6x4, 8x6, 12x8, 12x4, 16x6, 18x8**Default: 6x4*

This setting determines how many rows and columns display on the graphical front panel with the metering information. The configurable rows in the settings window change dynamically based on this setting.

**CONTENT***Range: Actual, Status, Text**Default: Text*

Select the type of content to display.

- Actual — an actual value/data. The **Configure** button becomes active for the actual value to be selected.
- Status — one of the operands selected from the STATUS INPUTS fields. Select it in the **STATUS INDEX** field.
- Text — indicates that text is to display instead of a metered value

**STATUS INDEX***Range: 1...16**Default:*

This field becomes active when the **CONTENT** field is set to Status. It selects the input from the STATUS INPUTS to display the on/off status of the selected operand.

A maximum of eight Status Inputs can be used per metering page, and 16 in all metering pages.

**TEXT***Range: up to 20 alphanumeric characters**Default:*

Enter the text to display on the graphical front panel. This field is active when the **CONTENT** field is set to Text or Status. When Status is selected, the text displays when the status input is in the "on" state.

**OFF TEXT***Range: up to 20 alphanumeric characters**Default:*

Enter the text to display on the graphical front panel when the element being monitored is in an off/closed state. This field is active when the **CONTENT** field is set to Status. The text displays when the status input is in the "off" state.

**FONT***Range: 16, 18, 20**Default: 16*

Set the font size to display on the graphical front panel.

**TEXT COLOR***Range: 24-bit color selector**Default: Black*

Set the text color to display in the specified cell.

**BACK COLOR**

Range: 24-bit color selector

Default: Grey

Set the background color to display in the specified cell.

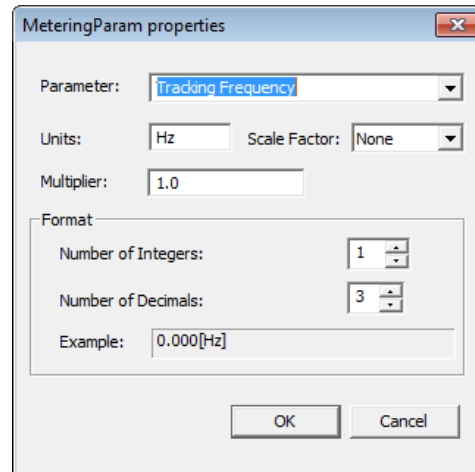
**ACTUAL (Configure)**

Range: Configure

Default: Configure

The **Configure** button becomes active when the **CONTENT** field is set to "Actual." The window specifies the metering data to display.

Figure 5-10: Metering value properties window

**Parameter**

Range: any FlexAnalog parameter

Default:

This setting selects a FlexAnalog parameter that specifies the metered value to display in the metering window. A FlexAnalog is an analog parameter.

**Units**

Range: up to eight alphanumeric characters

Default:

This setting specifies the units of measurement for the metered value and is populated based on the Parameter selected. The field can be left blank when units of measure do not apply.

**Scale Factor**

Range: G Giga, M Mega, k Kilo, None

Default: None

This setting allows the user to specify the scaling factor for the metering units value. Options depend on the Parameter.

**Multiplier**

Range: -1000000 to 1000000

Default: 1.0

This setting allows the user to specify a multiplier for the metering parameter value. The multiplier must be in compliance with the 32-bit floating-point format per IEEE 754, otherwise, the input value is represented as per the IEEE standard. For example, 1234.56789 is represented as 1234.567871094, and 9876.54321 as 9876.54296875.

**Number of Integers**

*Range: 1 to 12 in steps of 1*

*Default: 1*

This setting specifies the number of integers in the displayed metered value. It can be used to provide for leading character spacing of the display value.

For example, setting the number to 2 displays 00.000[V] and setting it to 3 displays 000.000[V].

**Number of Decimals**

*Range: 0 to 10 in steps of 1*

*Default: 3*

This setting specifies the number of decimal places in the displayed metered value. For example, setting the number to 1 displays 0.0 and setting it to 2 displays 0.00.

**5.3.3.4 Single-line diagram editor**

The path is **Settings > Product Setup > Graphical Panel > Single Line Diagram Editor**. Use is explained in the Interfaces chapter.

**5.3.3.5 Annunciator editor**

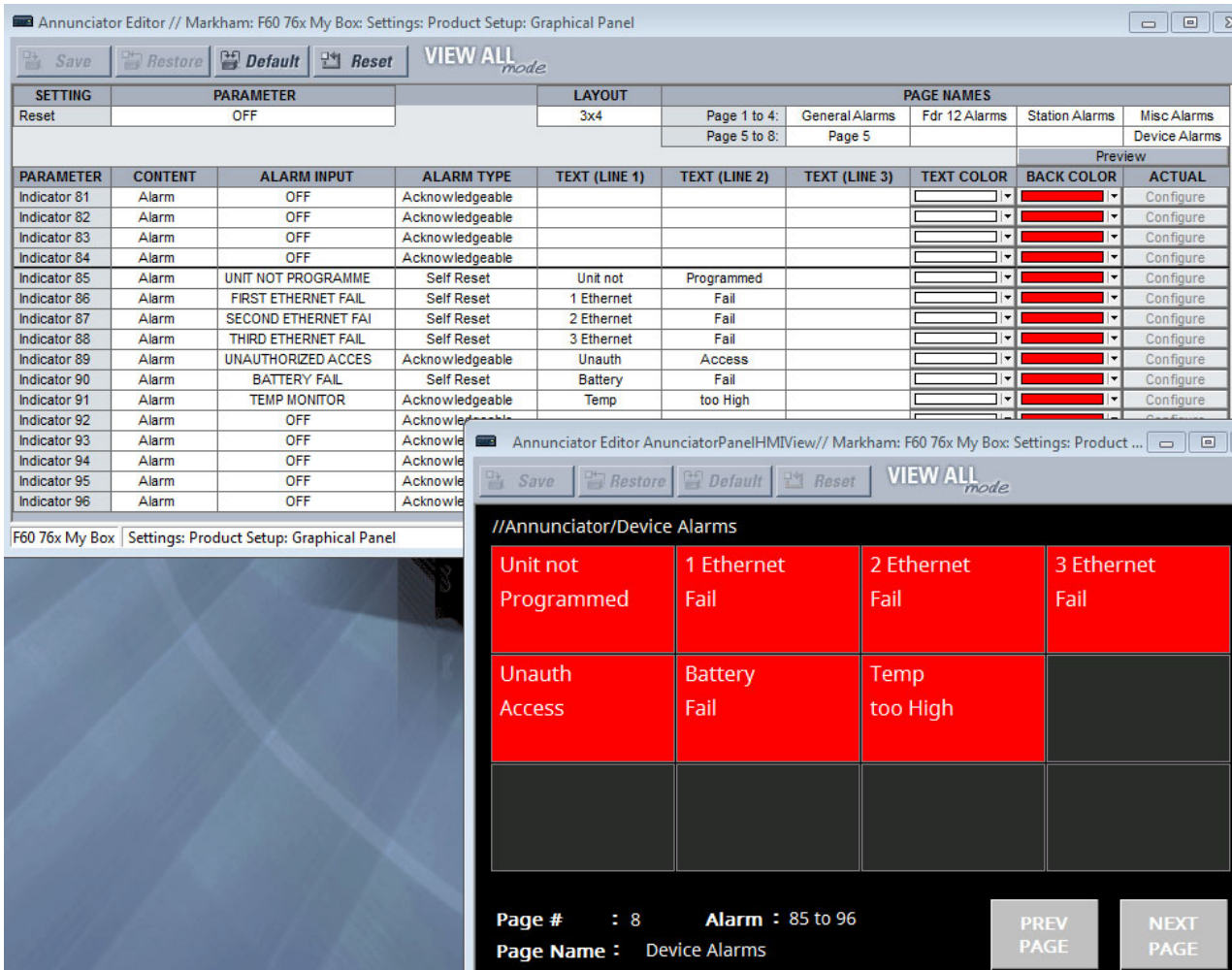
The annunciator editor is used to create annunciator content for the graphical front panel, including alarms and actual values. Use is explained in the Interfaces chapter.

The path is **Settings > Product Setup > Graphical Panel > Annunciator Editor**.

To add an alarm, access the Annunciator Editor, configure the Layout and Page Name, configure the alarm or actual value, set the text and color, then save. On the graphical front panel, view the content by pressing the **Annunciator** Tab pushbutton at the bottom of the **Home** page. (Alarms do not display automatically.) Acknowledge the alarm by navigating to it with the arrow pushbuttons, then pressing the **ENTER** or **RESET** pushbutton.

The figure shows alarms for basic functions. The last annunciator page is named Device Alarms. Alarms are set for the device being offline, Ethernet cable issues, unauthorized access, battery failure, and high ambient temperature. They can reset themselves when conditions return to normal, except for unauthorized access and temperature monitoring, which require the alarms to be acknowledged. The self-test error functions, here for Ethernet and battery failures, also have been enabled under **Settings > Product Setup > User-Programmable Self Tests** (not shown). When the alarms are triggered, they display with a red background. An alarm is acknowledged by using the arrow keys on the graphical front panel then pressing the **ENTER** button.

Figure 5-11: Annunciator editor with preview shown



**Reset**

Range: ON, OFF, any FlexLogic operand  
 Default: OFF

This setting selects a FlexLogic operand that when activated acknowledges/resets all annunciator windows in the graphical front panel. For example, to have the first user pushbutton resets all alarms, set this to **PUSHBUTTON 1 ON** and turn on the pushbutton under **Settings > Product Setup > User-Programmable Pushbuttons**. This setting is the same as the one defined in **Settings > Inputs/Outputs > Resetting > Reset Annunciator**. See the Resetting section later in this chapter.

**LAYOUT**

Range: 3x4, 4x6, 6x8  
 Default: 3x4

Selects the number of rows and columns to display on the annunciator pages. For example, 3x4 means 12 windows display per page over eight pages. Up to 96 entries are possible.  
 To view the layout, click the **Preview** button.

**PAGE NAMES**

Range: up to 20 alphanumeric characters  
 Default: Page 1...Page 8

Up to 20 characters can be input as the name of each annunciator page. The number of pages depends on the Layout. The name displays for the Tab pushbutton on the graphical front panel.



**PARAMETER**

*Range: Indicator 1...Indicator 96*

*Default: Indicator 1...Indicator 96*

Read-only field. Up to 96 windows are possible.

**CONTENT**

*Range: Actual, Alarm, Mixed*

*Default: Alarm*

Select if the cell is to be an alarm, an actual value, or a combination thereof, for example consists of a single metered value (set to "Actual"), contains a single alarm indication (set to "Alarm"), or contains both a metered value and an alarm indication (set to "Mixed").

**ALARM INPUT**

*Range: OFF, ON, any FlexLogic operand*

*Default: OFF*

Select a trigger for the alarm, or the input signal connected to the alarm. For example, when set to "FIRST ETHERNET FAIL" and the Ethernet cable connected to port 1 is removed, the alarm is triggered. (Note that when the Ethernet cable is inserted into an SFP connector and the SFP connector is removed, the alarm is not triggered.) The field is read-only for an actual value.

The selectable options are the FlexLogic operands specific to the product.

**ALARM TYPE**

*Range: Acknowledgeable, Self Reset, Latched*

*Default: Acknowledgeable*

Set the alarm type. The field is read-only for an actual value.

**Acknowledgeable** — Follow the state transitions, as outlined in the Annunciator section of the Interfaces chapter. The alarm blinks until acknowledged, then remains on until the condition clears.

**Self Reset** — Track the state of the input operand. The alarm turns on when the trigger activates and off when the trigger clears.

**Latched** — Alarm is on until acknowledged/reset individually or until the **RESET** button is pressed.

To acknowledge/reset/unlatch an alarm, use the arrow buttons on the graphical front panel and press the **ENTER** button.

**TEXT (LINE 1 to 3)**

*Range: up to 10 alphanumeric characters*

*Default:*

The text that displays in the annunciator cell. Three lines can be displayed. Note that a specified metering value replaces the text for the selected line. This means that a line can display text or be set to show an actual metered value. If the text does not display it is because an actual metered value is over-riding it; change the line for the text or for the actual value.

**TEXT COLOR**

*Range: 24-bit color selector*

*Default: White*

The color to display for the three text or actual value lines specified.

**BACK COLOR**

*Range: 24-bit color selector*

*Default: Red*

The background color to display for any triggered cell, for example when an alarm is triggered.

**ACTUAL (Configure)**

*Range: Configure*

*Default: Configure*

The **Configure** button becomes active when the **CONTENT** field is set to "Actual" or "Mixed." The window specifies the metering data to display.



**Parameter**

*Range: any FlexAnalog parameter*

*Default:*

This setting selects a FlexAnalog parameter that specifies the metered value to display in the annunciator alarm.

**Units**

*Range: up to eight alphanumeric characters*

*Default:*

This setting specifies the units of measurement for the metered value and is populated based on the Parameter selected. The field can be left blank when units of measure do not apply.

**Scale Factor**

*Range: G Giga, M Mega, k Kilo, None*

*Default: None*

This setting allows the user to specify the scaling factor for the metering units value. Options depend on the Parameter.

**Multiplier**

*Range: -1000000 to 1000000*

*Default: 1.0*

This setting allows the user to specify a multiplier for the metering parameter value. The multiplier must be in compliance with the 32-bit floating-point format per IEEE 754, otherwise, the input value is represented as per the IEEE standard. For example, 1234.56789 is represented as 1234.567871094, and 9876.54321 as 9876.54296875.

**Number of Integers**

*Range: 1 to 12 in steps of 1*

*Default: 1*

This setting specifies the number of integers in the displayed analog value. It can be used to provide for leading character spacing of the display value.

For example, setting the number to 2 displays 00.000[V] and setting it to 3 displays 000.000[V].

**Number of Decimals**

*Range: 0 to 10 in steps of 1*

*Default: 3*

This setting specifies the number of decimal places in the displayed analog value. For example, setting the number to 1 displays 0.0 and setting it to 2 displays 0.00.

**Display in Line**

*Range: 1, 2, 3*

*Default: 1*

This setting specifies the line in the annunciator alarm window to display the metered value. The actual value replaces the text for the selected line. For example, 2 means the value displays in line 2 of the text; any text configured to display in that line does not display.

**5.3.3.6 Configurable navigation**

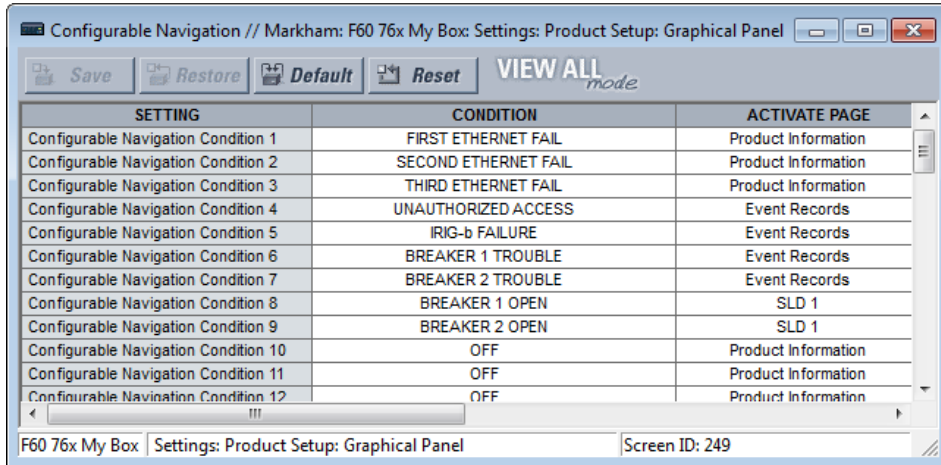
The path is **Settings > Product Setup > Graphical Panel > Configurable Navigation**.

This feature allows FlexLogic operands to trigger page display on the graphical front panel. It consists of 64 setting pairs, each with a condition and an activation page. The condition selects any FlexLogic operand. The activation page selects any page available for the graphical front panel. The page opens whenever the selected operand transitions from Off to On. The page remains open until rolling mode initiates, another trigger initiates from Configurable Navigation, or the **Home** button is pressed.

Avoid selecting condition operands that are likely to operate simultaneously but activate different pages, as only one page can be opened at a time. For example, do not select a single-line diagram page for breaker status open and select an annunciator page for a trip alarm.

In the example shown, failure of any of the three Ethernet ports triggers the Product Information page to display. With unauthorized access (such as wrong password), IRIG-B clock failure, or breaker trouble, the Event Records display. When a breaker opens, a single-line diagram displays. For the Ethernet and IRIG-B failure operation to work, these functions also have been enabled under **Settings > Product Setup > User-Programmable Self Tests**.

Figure 5-12: Configurable navigation editor



To use the feature, select a **CONDITION**, select an **ACTIVATE PAGE**, then save.

**CONDITION**

Range: OFF, ON, any FlexLogic operand

Default: OFF

Select the FlexLogic operand for the trigger. When it transitions from Off to On, it opens the page specified by the **ACTIVATE PAGE** setting. The FlexLogic operands selectable depend on product. Select it from the drop-down list. Or click or select the field and start typing to auto-fill. For example, typing F displays FIRST ETHERNET FAIL, while typing BR displays the first breaker option.

**ACTIVATE PAGE**

Range: Product Information, SLD 1...5, Annunciator, Annunciator 1...8, Actual Values Phasors 1...6, Tabular 1...5, Event Records, Targets

Default: Product Information

This setting specifies the page to display on the graphical front panel when the FlexLogic operand selected by its **CONDITION** setting transitions from Off to On.

The "Annunciator" option without a page number specifies the first annunciator page in the following sequence:

- The first annunciator page that contains an annunciator window that is in alarm (fast flash)
- The first annunciator page that contains an annunciator window that is in ringback. Ringback is a "return alert." Visual and audible signals are given when conditions return to normal, then the sequence returns to normal by pushing the **RESET** button.
- The first annunciator page that contains an annunciator window that is in abnormal state
- Annunciator page 1

The Tabular option displays a configured actual values/metering page.

The Targets option displays error messages, such as wrong transceiver, similar to event record entries.

**5.3.4 Clear relay records**

**SETTINGS ⇒ PRODUCT SETUP ⇒ CLEAR RELAY RECORDS**

CLEAR RELAY RECORDS

↔

CLEAR USER REPORTS:  
Off

Range: FlexLogic operand

⇕	CLEAR EVENT RECORDS: Off	Range: FlexLogic operand
⇕	CLEAR OSCILLOGRAPHY: Off	Range: FlexLogic operand
⇕	CLEAR DATA LOGGER: Off	Range: FlexLogic operand
⇕	CLEAR ENERGY: Off	Range: FlexLogic operand
⇕	RESET UNAUTH ACCESS: Off	Range: FlexLogic operand
↑	CLEAR DIR I/O STATS: Off	Range: FlexLogic operand Visible only for units with Direct I/O module

**RESET UNAUTH ACCESS** — Resets the access restriction counter.

Selected records can be cleared from user-programmable conditions with FlexLogic operands. Assigning user-programmable pushbuttons to clear specific records is a typical application for these commands. Since the G30 responds to rising edges of the configured FlexLogic operands, they must be asserted for at least 50 ms to take effect.

Clearing records with user-programmable operands is not protected by the command password. However, user-programmable pushbuttons are protected by the command password. Thus, if they are used to clear records, the user-programmable pushbuttons can provide extra security if required.

For example, to assign user-programmable pushbutton 1 to clear demand records, apply the following settings.

1. Assign the clear demand function to pushbutton 1 by making the following change in the **SETTINGS ⇒ PRODUCT SETUP ⇒ CLEAR RELAY RECORDS** menu:  
**CLEAR DEMAND:** "PUSHBUTTON 1 ON"
2. Set the properties for user-programmable pushbutton 1 by making the following changes in the **SETTINGS ⇒ PRODUCT SETUP ⇒ USER-PROGRAMMABLE PUSHBUTTONS ⇒ USER PUSHBUTTON 1** menu:  
**PUSHBUTTON 1 FUNCTION:** "Self-reset"  
**PUSHBTN 1 DROP-OUT TIME:** "0.20 s"



### 5.3.5 Communications

#### 5.3.5.1 Menu

**SETTINGS ⇒ PRODUCT SETUP ⇒ COMMUNICATIONS**

■ COMMUNICATIONS ■	↔	■ SERIAL PORTS ■	See below
	⇕	■ NETWORK ■	See page 5-42
	⇕	■ IPv4 ROUTE TABLE ■	See page 5-48
	⇕	■ MODBUS PROTOCOL ■	See page 5-51
	⇕	■ PROTOCOL ■	See page 5-51
	⇕	■ DNP PROTOCOL ■	See page 5-52
	⇕	■ DNP / IEC104 ■ POINT LISTS	See page 5-55

⇅	<input type="checkbox"/> IEC 61850 PROTOCOL <input type="checkbox"/>	Access in EnerVista See page 5-56
⇅	<input type="checkbox"/> WEB SERVER <input type="checkbox"/> HTTP PROTOCOL	See page 5-100
⇅	<input type="checkbox"/> TFTP PROTOCOL <input type="checkbox"/>	See page 5-101
⇅	<input type="checkbox"/> IEC 60870-5-104 <input type="checkbox"/> PROTOCOL	See page 5-101
⇅	<input type="checkbox"/> EGD PROTOCOL <input type="checkbox"/>	See page 5-103
⇅	<input type="checkbox"/> IEC103 <input type="checkbox"/> PROTOCOL	See page 5-104
↑	<input type="checkbox"/> USB 2.0 PORT <input type="checkbox"/>	See page 5-109

### 5.3.5.2 Serial ports

SETTINGS ⇒ PRODUCT SETUP ⇒ COMMUNICATIONS ⇒ SERIAL PORTS

<input type="checkbox"/> SERIAL PORTS <input type="checkbox"/>	↔	RS232 BAUD RATE: 115200	Range: 19200, 115200
	⇅	RS485 COM2 BAUD RATE: 19200	Range: 300, 1200, 2400, 4800, 9600, 14400, 19200, 28800, 33600, 38400, 57600, 115200 bit/s
	⇅	RS485 COM2 PARITY: Even	Range: None, Odd, Even
	↑	RS485 COM2 RESPONSE MIN TIME: 0 ms	Range: 0 to 1000 ms in steps of 10

The front RS232 port applies to enhanced and basic front panels.

**RS232 BAUD RATE, RS485 COM2 BAUD RATE, and PARITY** — The G30 is equipped with two independent serial communication ports. The front panel RS232 port (USB port with graphical front panel) is intended for local use. The rear COM2 port is RS485 and has settings for baud rate and parity. It is important that these parameters agree with the settings used on the computer or other equipment that is connected to these ports. Any of these ports can be connected to a computer running the EnerVista software, for example to download and upload setting files, view measured parameters, and upgrade the relay firmware. A maximum of 32 relays can be daisy-chained and connected to a DCS, PLC, or computer using the RS485 ports. If IEC 60870-103 is chosen as the protocol, valid baud rates are 9600 and 19200 bit/s, and valid parity is Even.

**RS485 COM2 RESPONSE MIN TIME** — This setting specifies the minimum time before the rear RS485 port transmits after receiving data from a host. This feature allows operation with hosts that hold the RS485 transmitter active for some time after each transmission.

### 5.3.5.3 Ethernet network topology

The G30 has three Ethernet ports. Each Ethernet port must belong to a different network or subnetwork. Configure the IP address and subnet to ensure that each port meets this requirement. Two subnets are different when the bitwise AND operation performed between their respective IP address and mask produces a different result. Communication becomes unpredictable when more than one port is configured to the same subnet.

#### Example 1

IP1/Mask1: 10.1.1.2/255.255.255.0 (where LAN 1 is 10.1.1.x/255.255.255.0)

IP2/Mask2: 10.2.1.2/255.255.255.0 (where LAN2 is 10.2.1.x/255.255.255.0)

IP3/Mask3: 10.3.1.2/255.255.255.0 (where LAN3 is 10.3.1.x/255.255.255.0)

**Example 2**

IP1/Mask1: 10.1.1.2/255.0.0.0 (where LAN1 is 10.x.x.x/255.0.0.0)

IP2/Mask2: 11.1.1.2/255.0.0.0 (where LAN2 is 11.x.x.x/255.0.0.0)

IP3/Mask3: 12.1.1.2/255.0.0.0 (where LAN3 is 12.x.x.x/255.0.0.0)

**Example 3 – Incorrect**

IP1/Mask1: 10.1.1.2/255.0.0.0

IP2/Mask2: 10.2.1.2/255.0.0.0

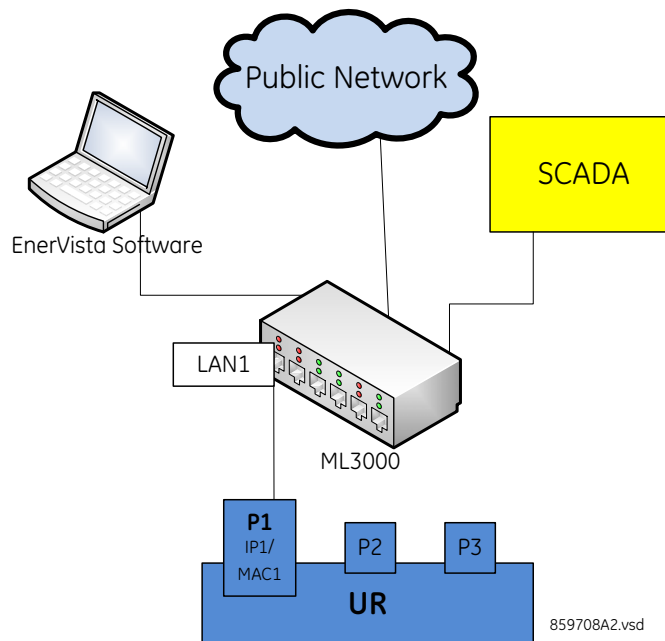
IP3/Mask3: 10.3.1.2/255.0.0.0

This example is incorrect because the mask of 255.0.0.0 used for the three IP addresses makes them belong to the same network of 10.x.x.x.

**Single LAN, no redundancy**

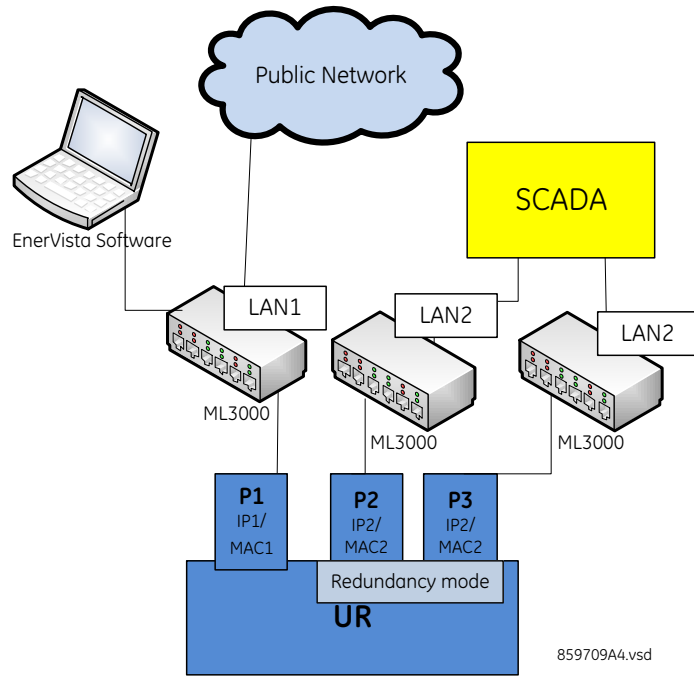
The topology shown in the following figure allows communications to SCADA, local configuration/monitoring through EnerVista, and access to the public network shared on the same LAN. No redundancy is provided.

**Figure 5-13: Network configuration for single LAN**

**Multiple LANS, with redundancy**

The following topology provides local configuration/monitoring through EnerVista software and access to the public network shared on LAN1, to which port 1 (P1) is connected. There is no redundancy provided on LAN1. Communications to SCADA is provided through LAN2. P2 and P3 are connected to LAN2, where P2 is the primary channel and P3 is the redundant channel. In this configuration, P3 uses the IP and MAC addresses of P2.

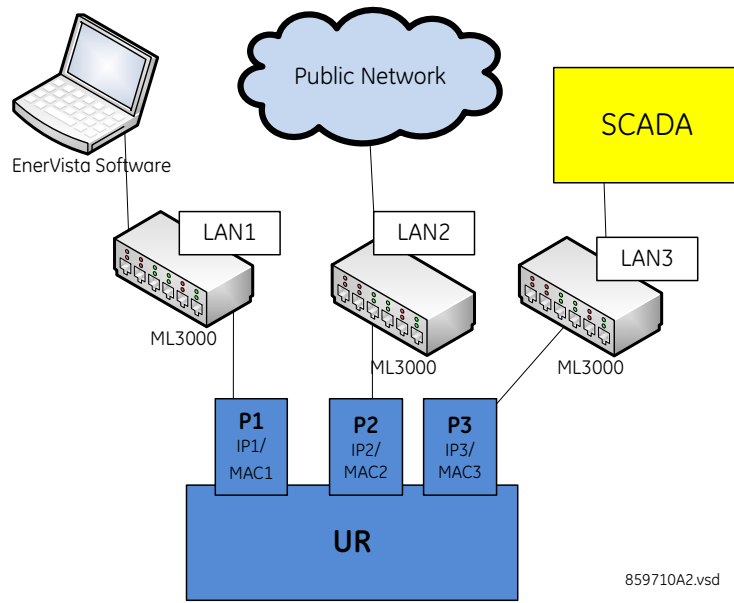
Figure 5-14: Multiple LANs, with redundancy



## 5 Multiple LANS, no redundancy

The following topology provides local configuration/monitoring through EnerVista software on LAN1, to which port 1 (P1) is connected, access to the public network on LAN2, to which port 2 (P2) is connected, and communications with SCADA on LAN3, to which port 3 (P3) is connected. There is no redundancy.

Figure 5-15: Multiple LANS, no redundancy



### 5.3.5.4 Network

As outlined in the previous section, when using more than one Ethernet port, configure each to belong to a different network or subnet using the IP addresses and mask. Configure the network IP and subnet settings before configuring the routing settings.

Follow the IP and subnet mask rules outlined in the Set IP Address in UR section of the Installation chapter.

To obtain a list of all port numbers used, for example for audit purposes, contact GE technical support with substantiating information, such as the serial number and order code of your device.

#### SETTINGS ⇒ PRODUCT SETUP ⇒ COMMUNICATIONS ⇒ NETWORK 1(3)

<div style="border: 1px solid black; padding: 2px;">           ■ NETWORK PORT 1            ■         </div>	↔	<div style="border: 1px solid black; padding: 2px;"> <b>PRT1 IP ADDRESS:</b>            127.0.0.1         </div>	Range: standard IPV4 address format
	⇅	<div style="border: 1px solid black; padding: 2px;"> <b>PRT1 SUBNET IP MASK:</b>            255.0.0.0         </div>	Range: standard IPV4 address format
	↑	<div style="border: 1px solid black; padding: 2px;"> <b>PRT1 FUNCTION:</b>            Enabled         </div>	Range: Enabled, Disabled
<div style="border: 1px solid black; padding: 2px;">           ■ NETWORK PORT 2            ■         </div>	↔	<div style="border: 1px solid black; padding: 2px;"> <b>PRT2 IP ADDRESS:</b>            127.0.0.1         </div>	Range: standard IPV4 address format
	⇅	<div style="border: 1px solid black; padding: 2px;"> <b>PRT2 SUBNET IP MASK:</b>            255.0.0.0         </div>	Range: standard IPV4 address format
	⇅	<div style="border: 1px solid black; padding: 2px;"> <b>PRT2 REDUNDANCY:</b>            None         </div>	Range: None, Failover, PRP Range if no PRP license: None, Failover
	⇅	<div style="border: 1px solid black; padding: 2px;"> <b>PRP MCST ADDR:</b>            01154E000100         </div>	Range: 01-15-4E-00-01-00 to 01-15-4E-00-01-FF
	↑	<div style="border: 1px solid black; padding: 2px;"> <b>PRT2 FUNCTION:</b>            Enabled         </div>	Range: Enabled, Disabled
<div style="border: 1px solid black; padding: 2px;">           ■ NETWORK PORT 3            ■         </div>	↔	<div style="border: 1px solid black; padding: 2px;"> <b>PRT3 IP ADDRESS:</b>            127.0.0.1         </div>	Range: standard IPV4 address format
	↑	<div style="border: 1px solid black; padding: 2px;"> <b>PRT3 SUBNET IP MASK:</b>            255.0.0.0         </div>	Range: standard IPV4 address format
	↑	<div style="border: 1px solid black; padding: 2px;"> <b>PRT3 FUNCTION:</b>            Enabled         </div>	Range: Enabled, Disabled

The IP addresses are used with the DNP, Modbus/TCP, IEC 61580, IEC 60870-5-104, TFTP, HTTP, and PRP protocols. PRP is explained in its own section later.

Use the front panel to change these settings. When online, the EnerVista software can be used to enable/disable each port only. In the Offline Window area, all settings can be changed except port 2 redundancy (depending on firmware version).

When using GOOSE, in failover or PRP mode, port 3 configuration in the CID file is ignored. The Port 3 ConnectedAP elements has no meaning, as ports 2 and 3 use the port 2 MAC address, IP address, and mask.

**PRT1 (2 or 3) IP ADDRESS** — This setting sets the port's IPv4 address in standard IPV4 format. This setting is valid on port 3 if port 2 **REDUNDANCY** is set to None.

**PRT1 (2 or 3) SUBNET MASK** — This setting sets the port's IPv4 subnet mask in standard IPV4 format. This setting is valid on port 3 if port 2 **REDUNDANCY** is set to None.

**PRT1 (2 or 3) FUNCTION** — This setting enable/disable network communication on the respective port. When the port function is Disabled, the network traffic on this port is disabled. The PRT2 redundancy setting has no effect on this functionality. The change takes effect upon relay restart.

If you disable a port here that is used to communicate between the relay and the software, this can take down all communication between the two. For example, an Ethernet connection set to the IP address of the relay can be disabled and cannot be reached, even when pinging. The port needs to be re-enabled, IP and any gateway addresses need to be checked, and the relay needs to be set to Programmed.

**PRT2 REDUNDANCY** — Determines if ports 2 and 3 operate in redundant or independent mode. If a license for PRP was purchased, the options are None, Failover, and PRP. If a license for PRP was not purchased, the options are None and Failover. In non-redundant mode (**REDUNDANCY** set to None), ports 2 and 3 operate independently with their own MAC, IP, and mask addresses. If **REDUNDANCY** is set to Failover, the operation of ports 2 and 3 is as follows:

- Ports 2 and 3 use the port 2 MAC address, IP address, and mask
- The configuration fields for IP address and mask on port 3 are hidden
- Port 3 is in standby mode and does not actively communicate on the Ethernet network but monitors its link to the Multilink switch. If port 2 detects a problem with the link, communications is switched to Port 3. Port 3 is, in effect, acting as a redundant or backup link to the network for port 2. Once port 2 detects that the link between itself and the switch is good and that communication is healthy for five minutes, then switching back to port 2 is performed. The delay in switching back ensures that rebooted switching devices connected to the G30, which signal their ports as active prior to being completely functional, have time to completely initialize themselves and become active. Once port 2 is active again, port 3 returns to standby mode.

If **REDUNDANCY** is set to PRP, the operation of ports 2 and 3 is as follows:

- Ports 2 and 3 use the port 2 MAC address, IP address, and mask
- The configuration fields for IP address and mask on port 3 are overwritten with those from port 2. This is visible on the front panel but not displayed in the EnerVista software.
- Port 2 **MCST ADDRESS** field is visible
- The port 2 PTP function still uses only port 2 and the port 3 PTP function still uses only port 3. The relay still synchronizes to whichever port has the best master. When ports 2 and 3 see the same master, as is typically the case for PRP networks, the port with the better connectivity is used.

Behavior for GOOSE messages is as follows:

- If **REDUNDANCY** is set to Failover or PRP, In order to transmit a GOOSE message on port 2, the CID file must be configured to have the corresponding GSE element in both ConnectedAPs S2 and S3. In the EnerVista software, the **TxGOOSE PORT ASSIGNMENT** needs to be "Ports-1,2,3" to transmit GOOSE on both ports 1 and 2, or "Ports-2,3" to have GOOSE only on port 2, with failover/ PRP.
- If **REDUNDANCY** is set to PRP, the port 2 configured GOOSE message is simultaneously transmitted on ports 2 and 3
- If **REDUNDANCY** is set to failover and the port 2 link fails, then only the port 2 configured GOOSE message is transmitted on port 3



The two ports must be connected to completely independent LANs with no single point of failure, such as common power supplies that feed switches on both LANs.

For any changes to this setting to take effect, restart the unit.

**PRT2 PRP MCST ADDR** — This setting allows the user to change the multicast address used by the PRP supervision frames. This setting is available if **REDUNDANCY** is set to PRP. All devices in the same PRP network need to have the same multicast address. Choose an address that does not conflict with another multicast protocol.

### 5.3.5.5 Far-End Fault Indication (FEFI)

Since 100BASE-FX does not support Auto-Negotiation, a Far-End Fault Indication (FEFI) feature is included since UR 7 that allows for detection of link failures.

The purpose of the Far-End Fault feature is to allow the stations on both ends of a pair of fibers to be informed when there is a problem with one of the fibers. Without the Far-End Fault feature, it is impossible for a fiber interface to detect a problem that affects only its transmit fiber.

When the Far-End Fault feature is supported, a loss of receive signal (link) causes the transmitter to generate a Far-End Fault pattern in order to inform the device at the far end of the fiber pair that a fault has occurred.



When the local receiver again detects a signal, the local transmitter automatically returns to normal operation.

If a Far-End Fault pattern is received by a fiber interface that supports the Far-End Fault feature and it is enabled, it reacts by dropping the link as if there were no signal at all.

If the receiving interface does not support the Far-End Fault feature or has it disabled, an incoming Far-End Fault pattern is ignored.

It is strongly recommended to have switches used for substation automation that support the Far-End Fault feature, especially when UR 7 redundancy Failover is selected for redundancy.

### 5.3.5.6 Parallel Redundancy Protocol (PRP)

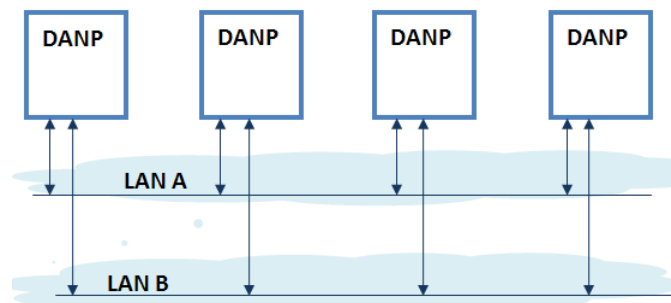


The G30 is provided with optional PRP capability. This feature is specified as a software option at the time of ordering. See the Order Codes section in chapter 2 for details.

The Parallel Redundancy Protocol (PRP) defines a redundancy protocol for high availability in substation automation networks. It applies to networks based on Ethernet technology (ISO/IEC 8802-3) and is based on the second edition (July 2012) of IEC 62439-3, clause 4.

PRP is designed to provide seamless recovery in case of a single failure in the network, by using a combination of LAN duplication and frame duplication. Identical frames are sent on two completely independent networks that connect source and destination. Under normal circumstances both frames reach the destination and one of them is sent up the OSI stack to the destination application, while the second one is discarded. If an error occurs in one of the networks and traffic is prevented from flowing on that path, connectivity is provided through the other network to ensure continuous communication. Take care when designing the two LANs, so that no single point of failure (such as a common power supply) is encountered, as such scenarios can bring down both LANs simultaneously.

Figure 5-16: Example of parallel redundant network



PRP uses specialized nodes called doubly attached nodes (DANPs) for handling the duplicated frames. DANP devices have an additional module, called a Link Redundancy Entity (LRE). LRE is responsible for duplicating frames and adding the specific PRP trailer when sending the frames out on the LAN, as well as making decisions on received frames as to which one is sent up the OSI stack to the application layer and which one is discarded. LRE is responsible for making PRP transparent to the higher layers of the stack.

In addition, there is a second type of specialized device used in PRP networks, called RedBox, with the role of connecting Single Attached Nodes (SANs) to a redundant network.

UR relays implement the DANP functionality. The RedBox functionality is not implemented.

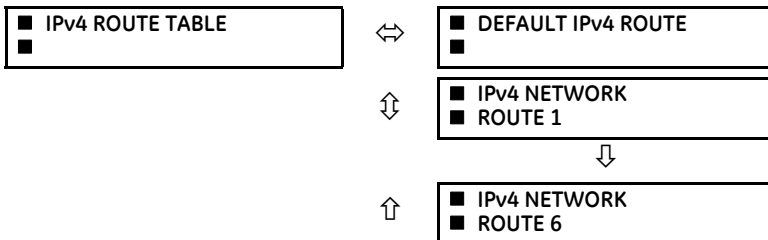
The original standard IEC 62439-3 (2010) was amended to align PRP with the High-availability Seamless Redundancy (HSR) protocol. To achieve this, the original PRP was modified at the cost of losing compatibility with the PRP 2010 version. The revised standard IEC 62439-3 (2012) is commonly referred to as PRP-1, while the original standard is PRP-0. The UR relays support PRP-1.

The relay implements PRP on two of its Ethernet ports, specifically Ports 2 and 3 of the CPU module. Use the previous section (network port configuration) to configure PRP.

PRP is purchased as a separate option. If purchased (valid order code), PRP can be enabled in configuration through a setting available on the network configuration menu, REDUNDANCY, which already has the capability of enabling failover redundancy. The options on this setting must be changed to accommodate two types of redundancy: failover and PRP. When REDUNDANCY is set to either failover or PRP, the ports dedicated for PRP (Ports 2 and 3) operate in redundant mode. In this mode, Port 3 uses the MAC, IP address, and mask of Port 2.

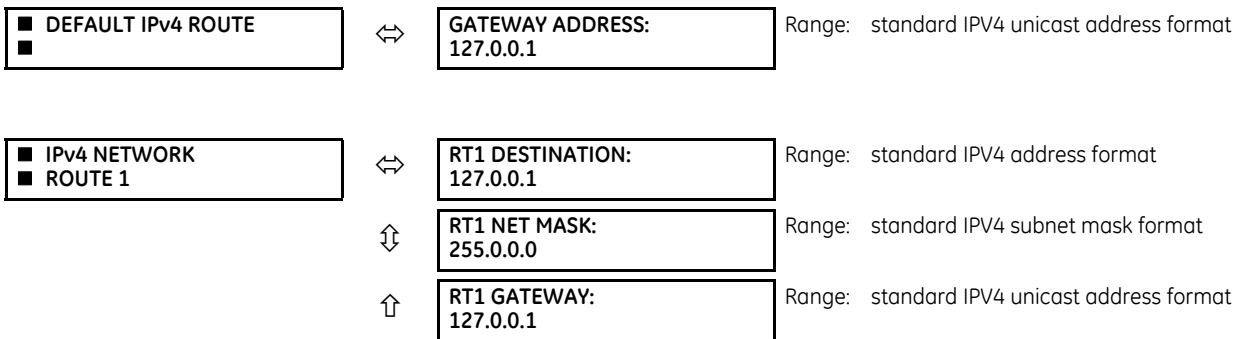
### 5.3.5.7 IPv4 route table

SETTINGS ⇒ PRODUCT SETUP ⇒ COMMUNICATIONS ⇒ IPv4 ROUTE TABLE 1(6)



A default route and up to six static routes can be configured.

The default route is used as the last choice when no other route towards a given destination is found.



Configure the network IP and subnet settings before configuring the routing settings.

### Add and delete static routes

Host routes are not supported at present.

The routing table configuration is available on the serial port and front panel. This is a deliberate decision, to avoid loss of connectivity when remotely configuring the G30.

By default, the value of the destination field is 127.0.0.1 for all static routes (1 to 6). This is equivalent to saying that the static routes are not configured. When the destination address is 127.0.0.1, the mask and gateway also must be kept on default values.

By default, the value of the route gateway address is 127.0.0.1. This means that the default route is not configured.

To add a route:

1. Use any of the static network route entries numbered 1 to 6 to configure a static network route. Once a route destination is configured for any of the entries 1 to 6, that entry becomes a static route and it must meet all the rules listed in the next section, General Conditions to be Satisfied by Static Routes.
2. To configure the default route, enter a default gateway address. Once a default gateway address is configured, it must be validated against condition 2 of the General Conditions to be Satisfied by Static Routes, where the route gateway must be on a connected network.

To delete a route:

1. Replace the route destination with the default loopback address of 127.0.0.1. When deleting a route, the mask and gateway also must be brought back to default values.

- Delete the default route by replacing the default gateway with the default value of 127.0.0.1.

### General conditions to be satisfied by static routes

The following rules are validated internally:

- The route mask has IP mask format. In binary this needs to be a set of contiguous bits of 1 from left to right, followed by one or more contiguous bits of 0.
- The route destination and mask must match. This can be verified by checking that  $RtDestination \text{ AND } RtMask = RtDestination$   
Example of good configuration:  $RtDestination = 10.1.1.0$ ;  $RtMask = 255.255.255.0$   
Example of bad configuration:  $RtDestination = 10.1.1.1$ ;  $RtMask = 255.255.255.0$

The following rules must be observed when you configure static routes:

- The route destination must not be a connected network
- The route gateway must be on a connected network. This rule applies to the gateway address of the default route as well. This can be verified by checking that:  
 $(RtGwy \text{ AND } Prt1Mask) == (Prt1IP \text{ AND } Prt1Mask) \text{ OR } (RtGwy \text{ AND } Prt2Mask) == (Prt2IP \text{ AND } Prt2Mask) \text{ OR } (RtGwy \text{ AND } Prt3Mask) == (Prt3IP \text{ AND } Prt3Mask)$

where

& is the bitwise-AND operator

== is the equality operator

|| is the logical OR operator

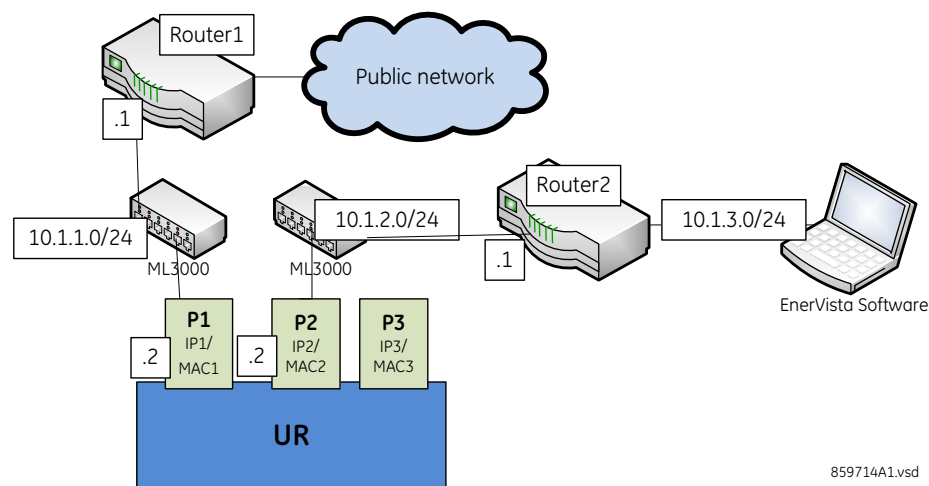
### Routing behavior compared to previous releases

Prior to release 7.10, UR devices did not have an explicit manner of configuring routes. The only available route was the default route configured as part of the network settings (port gateway IP address). This limited the ability to route to specific destinations, particularly if these destinations were reachable through a different interface than the one on which the default gateway was.

Starting with UR 7.10, up to six static network routes can be configured in addition to a default route. The default route configuration was also moved from the network settings into the routing section.

The figure shows an example of topology that benefits from the addition of static routes.

Figure 5-17: Using static routes



In the figure, the UR connects through the following two Ethernet ports:

- Port 1 (IP address 10.1.1.2) connects the UR to LAN 10.1.1.0/24 and to the Internet through Router1. Router1 has an interface on 10.1.1.0/24 and the IP address of this interface is 10.1.1.1.

- Port 2 (IP address 10.1.2.2) connects the UR to LAN 10.1.2.0/24 and to the EnerVista software through Router2. Router2 has an interface on 10.1.2.0/24 and the IP address of this interface is 10.1.2.1.

The configuration before release 7.10 was as follows:

- PRT1 IP ADDRESS = 10.1.1.2  
PRT1 SUBNET IP MASK = 255.255.255.0  
PRT1 GWY IP ADDRESS = 10.1.1.1  
PRT2 IP ADDRESS = 10.1.2.2  
PRT2 SUBNET IP MASK = 255.255.255.0

The behavior before release 7.10 was as follows. When sending packets to EnerVista, the UR noticed that the destination was not on a connected network and it tried to find a route to destination. Since the default route was the only route it knew, it used it. Yet EnerVista was on a private network, which was not reachable through Router1. Hence a destination unreachable message was received from the router.

The configuration starting with release 7.10 is as follows:

- PRT1 IP ADDRESS = 10.1.1.2  
PRT1 SUBNET IP MASK = 255.255.255.0  
PRT2 IP ADDRESS = 10.1.2.2  
PRT2 SUBNET IP MASK = 255.255.255.0  
IPV4 DEFAULT ROUTE: GATEWAY ADDRESS = 10.1.1.1  
STATIC NETWORK ROUTE 1: RT1 DESTINATION = 10.1.3.0/24; RT1 NET MASK = 255.255.255.0; and RT1 GATEWAY = 10.1.2.1

The behavior since release 7.10 is as follows. There is one added static network route to the destination 10.1.3.0/24, where a computer running EnerVista is located. This static route uses a different gateway (10.1.2.1) than the default route. This gateway is the address of Router2, which has knowledge about 10.1.3.0 and is able to route packets coming from the UR and destined to EnerVista.

5

### Show routes and ARP tables

This feature is available on the Web interface, where the main menu contains an additional Communications menu and two submenus:

- Routing Table
- ARP Table

The tables outline the information displayed when the two submenus are selected.

**Table 5-7: Routing table information**

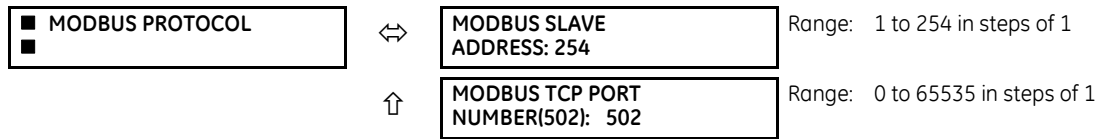
Field	Description
Destination	The IP address of the remote network to which this route points
Mask	The network mask for the destination
Gateway	The IP address of the next router to the remote network
Interface	Interface through which the specified network can be reached

**Table 5-8: IP ARP information**

Field	Description
IP Address	The network address that corresponds to Hardware Address
Age (min)	Age, in minutes, of the cache entry. A hyphen (-) means the address is local.
Hardware Address	LAN hardware address, a MAC address that corresponds to network address
Type	Dynamic or Static
Interface	Interface to which this address mapping has been assigned

### 5.3.5.8 Modbus protocol

SETTINGS ⇒ PRODUCT SETUP ⇒ COMMUNICATIONS ⇒ MODBUS PROTOCOL



The serial communication ports utilize the Modbus protocol, unless the port is configured for DNP or IEC 60870-5-103 operation. This allows the EnerVista UR Setup software to be used on the port. UR devices operate as Modbus slave devices only.

For more information on the protocol, including the memory map table, see the UR Family Communications Guide.

**MODBUS SLAVE ADDRESS** — When using the Modbus protocol on the RS232 port, the G30 responds regardless of the **MODBUS SLAVE ADDRESS** programmed. For the RS485 port, each device on the serial bus must have a unique slave address from 1 to 254. Address 0 and addresses from 248 and up are reserved by the Modbus protocol specification, and so their use here is not recommended. Address 0 is the broadcast address to which all Modbus slave devices listen. Addresses do not have to be sequential, but no two devices can have the same address or conflicts resulting in errors occur. Generally, starting at 1, set each device added to the link to use the next higher address. When using Modbus TCP/IP, the client must use the programmed **MODBUS SLAVE ADDRESS** value in the Unit Identifier field.

**MODBUS TCP PORT NUMBER** — Modbus over TCP/IP can also be used on any of the Ethernet ports. The listening TCP port 502 is reserved for Modbus communications, and only in exceptional cases when **MODBUS TCP PORT NUMBER** is set to any other port. The **MODBUS TCP PORT NUMBER** setting sets the TCP port used by Modbus on Ethernet. A **MODBUS TCP PORT NUMBER** of 0 disables Modbus over TCP/IP, meaning closes the Modbus TCP port. When the port number is changed to 0, the change takes effect when the G30 is restarted. When it is set to 0, use the front panel or serial port to communicate with the relay.

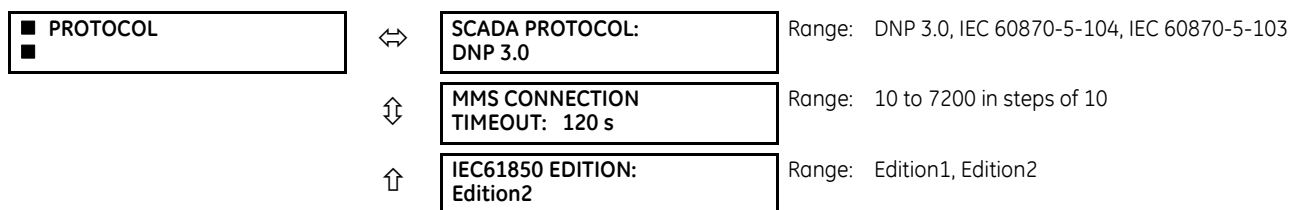


Do not set more than one protocol to the same TCP/UDP port number, as this results in unreliable operation of those protocols.

NOTE

### 5.3.5.9 Protocol selection

SETTINGS ⇒ PRODUCT SETUP ⇒ COMMUNICATIONS ⇒ PROTOCOL



The **PROTOCOL** menu allows selection of one of the following protocols: DNP 3.0, IEC60870-104, or IEC60870-103.

**SCADA PROTOCOL** — This setting selects the SCADA protocol on which the unit communicates, among DNP3.0, IEC 60870-104, and IEC 60870-103, with DNP being the default. Options depend on order code. For any change to take effect, restart the unit.

**MMS CONNECTION TIMEOUT** — This setting specifies a time delay for the detection of network TCP connection lost. If there is no data traffic on the TCP connection for greater than the time specified by this setting, the connection is terminated. This frees up the connection to be re-used by a client. A setting of 10 seconds disables this timer. The TCP connection then is managed by a standard TCP KeepAlive message sequence. These messages are transmitted every 20 seconds when there is no MMS communication between the relay and the client. If there are no responses to the TCP KeepAlive messages, the connection is closed. For any change to this setting to take effect, restart the unit. The change takes effect for a new connection. For any existing open connection when the change is made, close and re-open the connection. Cycling power to the relay also applies the new setting.

The table shows which of DNP 3.0, IEC 60870-5-104, IEC 60870-5-103, and IEC 61850 protocols are operational on the RS232, RS485, and Ethernet ports. It shows all possible combinations of the **PROTOCOL** and **DNP CHANNEL 1(2) PORT** settings.

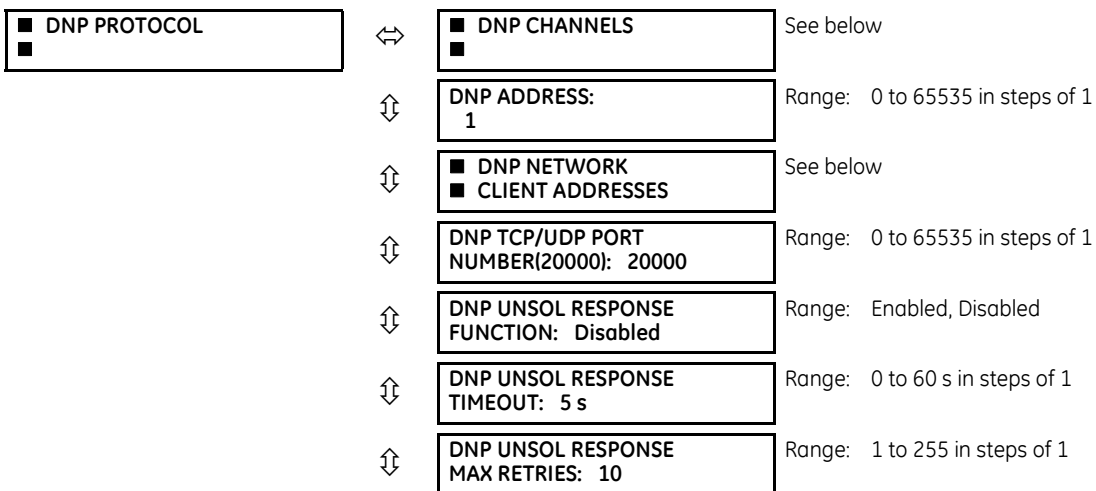
Table 5-9: Port and protocol combinations

PROTOCOL setting	DNP CHANNEL 1(2) PORT settings	RS232	RS485	Ethernet
DNP	Channel 1: Eth TCP Channel 2: Eth TCP	Modbus	Modbus	DNP, Modbus, IEC 61850
	Channel 1: Eth TCP Channel 2: none	Modbus	Modbus	DNP, Modbus, IEC 61850
	Channel 1: none Channel 2: Eth TCP	Modbus	Modbus	DNP, Modbus, IEC 61850
	Channel 1: Eth UDP Channel 2: none	Modbus	Modbus	DNP, Modbus, IEC 61850
	Channel 1: Eth TCP Channel 2: RS485	Modbus	DNP	DNP, Modbus, IEC 61850
	Channel 1: Eth TCP Channel 2: RS232	DNP	Modbus	DNP, Modbus, IEC 61850
	Channel 1: Eth UDP Channel 2: RS485	Modbus	DNP	DNP, Modbus, IEC 61850
	Channel 1: Eth UDP Channel 2: RS232	DNP	Modbus	DNP, Modbus, IEC 61850
	Channel 1: RS485 Channel 2: Eth TCP	Modbus	DNP	DNP, Modbus, IEC 61850
	Channel 1: RS232 Channel 2: Eth TCP	DNP	Modbus	DNP, Modbus, IEC 61850
	Channel 1: RS485 Channel 2: RS232	DNP	DNP	Modbus, IEC 61850
	Channel 1: RS232 Channel 2: RS485	DNP	DNP	Modbus, IEC 61850
Channel 1: RS485 Channel 2: none	Modbus	DNP	Modbus, IEC 61850	
IEC 104		Modbus	Modbus	IEC 104, Modbus, IEC 61850
IEC 103		Modbus	IEC 103	Modbus, IEC 61850

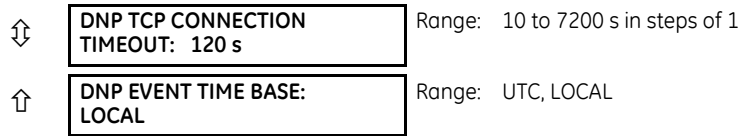
**IEC61850 EDITION** — Switches between Editions 1 and 2 of the IEC 61850 protocol. Settings default with the change, except GGIO1, GGIO2, GGIO4, and those for the graphical front panel. A message displays that a reboot is required, which can be done using **Maintenance > Reboot Relay Command**.

### 5.3.5.10 DNP protocol

SETTINGS ⇒ PRODUCT SETUP ⇒ COMMUNICATIONS ⇒ DNP PROTOCOL



↕	DNP UNSOL RESPONSE DEST ADDRESS: 1	Range: 0 to 65519 in steps of 1
↕	DNP CURRENT SCALE FACTOR: 1	Range: 0.001, 0.01, 0.1, 1, 10, 100, 1000, 10000, 100000, 1000000, 10000000, 100000000
↕	DNP VOLTAGE SCALE FACTOR: 1	Range: 0.001, 0.01, 0.1, 1, 10, 100, 1000, 10000, 100000, 1000000, 10000000, 100000000
↕	DNP POWER SCALE FACTOR: 1	Range: 0.001, 0.01, 0.1, 1, 10, 100, 1000, 10000, 100000, 1000000, 10000000, 100000000
↕	DNP ENERGY SCALE FACTOR: 1	Range: 0.001, 0.01, 0.1, 1, 10, 100, 1000, 10000, 100000, 1000000, 10000000, 100000000
↕	DNP PF SCALE FACTOR: 1	Range: 0.001, 0.01, 0.1, 1, 10, 100, 1000, 10000, 100000, 1000000, 10000000, 100000000
↕	DNP OTHER SCALE FACTOR: 1	Range: 0.001, 0.01, 0.1, 1, 10, 100, 1000, 10000, 100000, 1000000, 10000000, 100000000
↕	DNP CURRENT DEFAULT DEADBAND: 30000	Range: 0 to 100000000 in steps of 1
↕	DNP VOLTAGE DEFAULT DEADBAND: 30000	Range: 0 to 100000000 in steps of 1
↕	DNP POWER DEFAULT DEADBAND: 30000	Range: 0 to 100000000 in steps of 1
↕	DNP ENERGY DEFAULT DEADBAND: 30000	Range: 0 to 100000000 in steps of 1
↕	DNP PF DEFAULT DEADBAND: 30000	Range: 0 to 100000000 in steps of 1
↕	DNP OTHER DEFAULT DEADBAND: 30000	Range: 0 to 100000000 in steps of 1
↕	DNP TIME SYNC IIN PERIOD: 1440 min	Range: 1 to 10080 min. in steps of 1
↕	DNP MESSAGE FRAGMENT SIZE: 240	Range: 30 to 2048 in steps of 1
↕	DNP OBJECT 1 DEFAULT VARIATION: 2	Range: 1, 2
↕	DNP OBJECT 2 DEFAULT VARIATION: 2	Range: 1, 2, 3
↕	DNP OBJECT 20 DEFAULT VARIATION: 1	Range: 1, 2, 5, 6
↕	DNP OBJECT 21 DEFAULT VARIATION: 1	Range: 1, 2, 9, 10
↕	DNP OBJECT 22 DEFAULT VARIATION: 1	Range: 1, 2, 5, 6
↕	DNP OBJECT 23 DEFAULT VARIATION: 1	Range: 1, 2, 5, 6
↕	DNP OBJECT 30 DEFAULT VARIATION: 1	Range: 1, 2, 3, 4, 5
↕	DNP OBJECT 32 DEFAULT VARIATION: 1	Range: 1, 2, 3, 4, 5, 7
↕	DNP NUMBER OF PAIRED CONTROL POINTS: 0	Range: 0 to 32 in steps of 1



The Distributed Network Protocol (DNP) allows for the optimization of control and data acquisition between the equipment in the substation and the central control center. The protocol is scalable; that is, it is designed to be compatible with the latest high speed LAN technology yet still be implemented over slower speed serial links.

The DNP improves upon many master-slave protocols by improving overall communication performance requirements and provides time-stamping with millisecond accuracy.

The G30 supports DNP version 3.0.

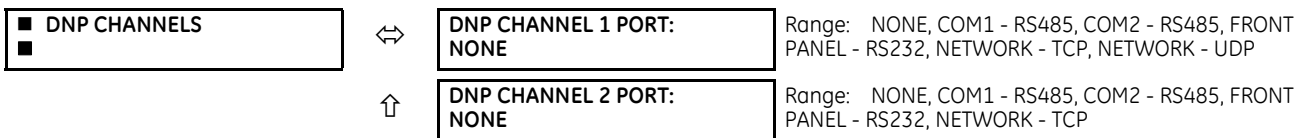
DNP is enabled when the **SETTINGS ⇒ PRODUCT SETUP ⇒ COMMUNICATIONS ⇒ PROTOCOL** setting is set to DNP 3.0. The G30 can be used as a DNP slave device connected to multiple DNP masters (usually an RTU or a SCADA master station). Since the G30 maintains two sets of DNP data change buffers and connection information, two DNP masters can actively communicate with the G30 at one time.

DNP is not available using the USB port on the graphical front panel.

See the UR Family Communications Guide for more information on DNP.


The DNP Channels sub-menu is shown.

**SETTINGS ⇒ PRODUCT SETUP ⇒ COMMUNICATIONS ⇒ DNP PROTOCOL ⇒ DNP CHANNELS**



The **DNP CHANNEL 1 PORT** and **DNP CHANNEL 2 PORT** settings select the communications port assigned to the DNP protocol for each channel. Once DNP is assigned to a serial port, DNP is the only protocol running on that port; Modbus or IEC 60870-5-103 are disabled. If DNP is assigned to RS485, the protocol must be set to DNP on the serial port configuration as well, for the change to take effect. When the **DNP CHANNEL 1(2) PORT** setting is set to "Network - TCP," the channel 1(2) DNP protocol can be used over TCP/IP on the Ethernet ports. When this value is set to "Network - UDP," the DNP protocol can be used over UDP/IP on channel 1 only. The "Front Panel - RS232" setting does not apply to the graphical front panel; when selected the DNP client cannot establish a connection on a USB port.

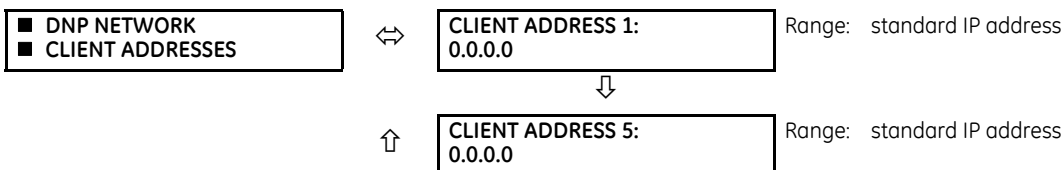
For any change to take effect, restart the relay.

 Do not set more than one protocol to the same TCP/UDP port number, as this results in unreliable operation of those protocols.

The **DNP ADDRESS** setting is the DNP slave address. This number identifies the G30 on a DNP communications link. Assign a unique address to each DNP slave.

The G30 can specify a maximum of five clients for its DNP connections. These are IP addresses for the controllers to which the G30 can connect. The settings follow.

**SETTINGS ⇒ PRODUCT SETUP ⇒ COMMUNICATIONS ⇒ DNP PROTOCOL ⇒ DNP NETWORK CLIENT ADDRESSES**



The **DNP TCP/UDP PORT NUMBER** setting is for normal DNP operation. To close the port, set the port number to 0. The change takes effect when the G30 is restarted.



The **DNP UNSOL RESPONSE FUNCTION** is set to “Disabled” for RS485 applications since there is no collision avoidance mechanism. The **DNP UNSOL RESPONSE TIMEOUT** sets the time the G30 waits for a DNP master to confirm an unsolicited response. The **DNP UNSOL RESPONSE MAX RETRIES** setting determines the number of times the G30 retransmits an unsolicited response without receiving confirmation from the master; a value of “255” allows infinite re-tries. The **DNP UNSOL RESPONSE DEST ADDRESS** is the DNP address to which all unsolicited responses are sent. The IP address to which solicited responses are sent is determined by the G30 from the current TCP connection or the most recent UDP message.

The DNP scale factor settings are numbers used to scale analog input point values. These settings group the G30 analog input data into the following types: current, voltage, power, energy, power factor, and other. Each setting represents the scale factor for all analog input points of that type. For example, if the **DNP VOLTAGE SCALE FACTOR** setting is set to “1000,” all DNP analog input points that are voltages are returned with values 1000 times smaller (for example, a value of 72000 V on the G30 is returned as 72). These settings are useful when analog input values must be adjusted to fit within certain ranges in DNP masters. Note that a scale factor of 0.1 is equivalent to a multiplier of 10 (that is, the value is 10 times larger).

The **DNP DEFAULT DEADBAND** settings determine when to trigger unsolicited responses containing analog input data. These settings group the G30 analog input data into the following types: current, voltage, power, energy, power factor, and other. Each setting represents the default deadband value for all analog input points of that type. For example, to trigger unsolicited responses from the G30 when any current values change by 15 A, the **DNP CURRENT DEFAULT DEADBAND** setting is set to “15.” Note that these settings are the deadband default values. DNP object 34 points can be used to change deadband values, from the default, for each individual DNP analog input point. For any change to take effect, restart the relay. Whenever power is removed and re-applied to the G30, the default deadbands are in effect.

The **DNP TIME SYNC IIN PERIOD** setting determines how often the Need Time Internal Indication (IIN) bit is set by the G30. Changing this time allows the DNP master to send time synchronization commands more or less often, as required.

The **DNP MESSAGE FRAGMENT SIZE** setting determines the size, in bytes, at which message fragmentation occurs. Large fragment sizes allow for more efficient throughput; smaller fragment sizes cause more application layer confirmations to be necessary, which provides more robust data transfer over noisy communication channels.



Check the “DNP Points Lists” G30 web page to view the analog inputs and/or binary inputs points lists. This page can be viewed with a web browser by entering the IP address of the G30 Ethernet port employed to access the G30 Main Menu, then by clicking the **Device Information Menu** item, then the **DNP Points Lists** item.

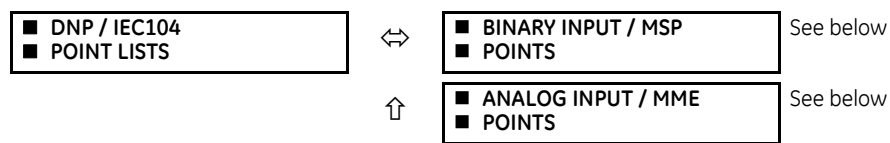
The **DNP OBJECT 1 DEFAULT VARIATION** to **DNP OBJECT 32 DEFAULT VARIATION** settings select the DNP default variation number for object types 1, 2, 20, 21, 22, 23, 30, and 32. The default variation refers to the variation response when variation 0 is requested and/or in class 0, 1, 2, or 3 scans. See the DNP Implementation section in the UR Family Communications Guide.

The DNP binary outputs typically map one-to-one to IED data points. That is, each DNP binary output controls a single physical or virtual control point in an IED. In the G30 relay, DNP binary outputs are mapped to virtual inputs. However, some legacy DNP implementations use a mapping of one DNP binary output to two physical or virtual control points to support the concept of trip/close (for circuit breakers) or raise/lower (for tap changers) using a single control point. That is, the DNP master can operate a single point for both trip and close, or raise and lower, operations. The G30 can be configured to support paired control points, with each paired control point operating two virtual inputs. The **DNP NUMBER OF PAIRED CONTROL POINTS** setting allows configuration of 0 to 32 binary output paired controls. Points not configured as paired operate on a one-to-one basis.

The **DNP TCP CONNECTION TIMEOUT** setting specifies a time delay for the detection of dead network TCP connections. If there is no data traffic on a DNP TCP connection for greater than the time specified by this setting, the connection is aborted by the G30. This frees up the connection to be re-used by a client. For any change to take effect, restart the relay.

### 5.3.5.11 DNP / IEC 60870-5-104 point lists

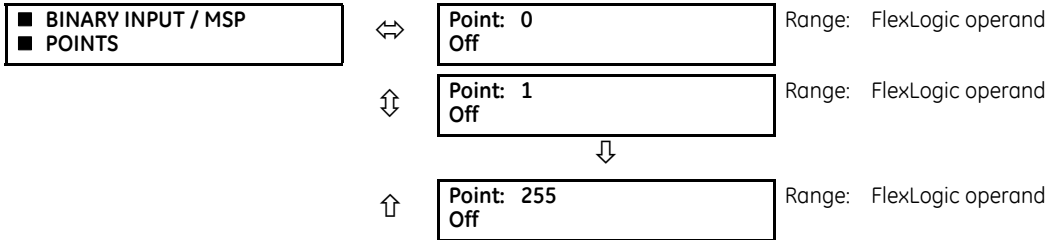
SETTINGS ⇒ PRODUCT SETUP ⇒ COMMUNICATIONS ⇒ DNP / IEC104 POINT LISTS



Up to 256 binary and up to 256 analog input points for the DNP protocol, or the MSP and MME points for IEC 60870-5-104 protocol, can be configured. The value for each point is user-programmable and can be configured by assigning FlexLogic operands for binary inputs / MSP points or FlexAnalog parameters for analog inputs / MME points.

The menu for the binary input points (DNP) or MSP points (IEC 60870-5-104) follows.

**SETTINGS ⇒ PRODUCT SETUP ⇒ COMMUNICATIONS ⇒ DNP / IEC104 POINT LISTS ⇒ BINARY INPUT / MSP POINTS**

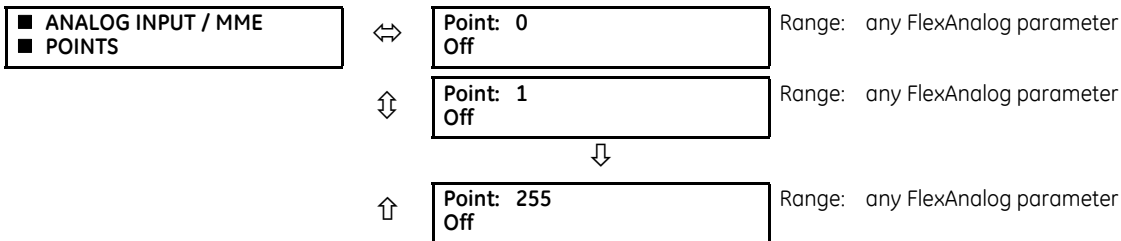


Up to 256 binary input points can be configured for the DNP or IEC 60870-5-104 protocols. The points are configured by assigning an appropriate FlexLogic operand. See the Introduction to FlexLogic section in this chapter for the range of assignable operands.

Changes to the DNP / IEC 60870-5-104 point lists take effect when the G30 is restarted.


The menu for the analog input points (DNP) or MME points (IEC 60870-5-104) follows.

**SETTINGS ⇒ PRODUCT SETUP ⇒ COMMUNICATIONS ⇒ DNP / IEC104 POINT LISTS ⇒ ANALOG INPUT / MME POINTS**




Up to 256 analog input points can be configured for the DNP or IEC 60870-5-104 protocols. The analog point list is configured by assigning an appropriate FlexAnalog parameter to each point. See the FlexAnalog Parameters section in Appendix A for the range of assignable parameters.


Changes to the DNP / IEC 60870-5-104 point lists take effect when the G30 is restarted.

 The DNP / IEC 60870-5-104 point lists always begin with point 0 and end at the first “Off” value. Since DNP / IEC 60870-5-104 point lists must be in one continuous block, any points assigned after the first “Off” point are ignored.

**5.3.5.12 IEC 61850 protocol**

 The G30 is provided with optional IEC 61850 communications. This feature is specified as a software option at the time of ordering. See the Order Codes section in chapter 2 for details.

The IEC 61850 settings are accessible in EnerVista software or a substation configuration language (SCL) generating tool. The path is **Settings > Product Setup > Communications > IEC 61850** or **Settings > IEC 61850**. The settings are not accessible from the front panel of the device.

 IEC 61850 messaging can form part of protection schemes. Consider IEC 61850 settings with the same criticality as protection element settings. To ensure reliable performance of protection schemes utilizing IEC 61850 messaging, route IEC 61850 traffic on a separate port from SCADA communications, or use redundant, independent ports, and a high-speed network recovery method, such as PRP.

## Overview

IEC 61850 is a series of international standards and technical reports applicable to power utility automation systems. It includes semantics, abstract communication services, specific communication services, performance specifications, network engineering guidelines, configuration description methodologies, and engineering processes. The standard enables interoperability among intelligent electronic devices (IEDs) from different suppliers and interoperability among software configuration tools from different suppliers. Interoperability in this case is the ability for IEDs to operate on the same network or communication path sharing information and commands, and for configuration tools to understand each other's configuration files.

The UR family supports a large subset of IEC 61850 features. These are detailed in the UR Family Communications Guide and include the information model, GOOSE publish, GOOSE subscribe, buffered report server, unbuffered report server, and Manufacturing Message Specification (MMS) query, read, write, and control services. In addition, the URs and their EnerVista UR Setup software support IEC 61850 Substation Configuration Language (SCL) file import/export and merging.

Many settings of UR protection, control, and monitoring elements, that is to say elements that are not concerned with the IEC 61850 protocol, can nevertheless be accessed via IEC 61850. These settings are documented elsewhere in this Settings chapter. This section of the Settings chapter deals solely with the settings that configure the IEC 61850 protocol itself.

The maximum number of simultaneous clients supported by the UR family is five.

## IEC 61850 Editions 1 and 2

This release supports IEC 61850 Edition 1 and Edition 2. The default is Edition 2.

Select IEC 61850 Edition 1 or Edition 2 under **Settings > Product Setup > Communications > Protocol**. Switching defaults the IEC 61850 settings, except GGIO1, GGIO2, GGIO4, and those for the graphical front panel. A message displays that a reboot is required, which can be done using **Maintenance > Reboot Relay Command**.

Edition 2.0 is used with certain modifications according to IEC/TR 61850-90-5. Only edition 2.0 61850 configuration tools can interoperate with edition 2.0 devices, such as the UR 7.3x, 7.4x, or 7.6x release. When using Edition 2, the UR release uses edition 2.0 SCL, which differs from edition 1.0 SCL. GSSE, fixed GOOSE, and fixed report services of Edition 1 are not supported in Edition 2, and thus UR devices using these features have to be converted to configurable GOOSE to communicate with a 7.3x, 7.4x, or 7.6x device.

When set to Edition 1

- The Test Flag in the Tx GOOSE message header is set to TRUE when the **TEST MODE FUNCTION** is set to Forcible or Isolated
- The test flag in the received GOOSE message header is not validated
- Routable GOOSE is not supported
- The FlexLogic category does not display in the IEC 61850 panels in the EnerVista UR Setup software
- With SCL file import, for Edition 1 the IP address in the ConnectedAP element must match one IP address of the device, while for Edition 2 one of the three IP addresses in the ConnectedAP element must match

The fields that display in the software depend on the Edition selected and the G30. Differences are noted in the sections that follow. If required, consult the Model Implementation Conformance Statement (MICS) section of the UR Family Communications Guide to understand what applies to your setup.

## EnerVista setup for IEC 61850

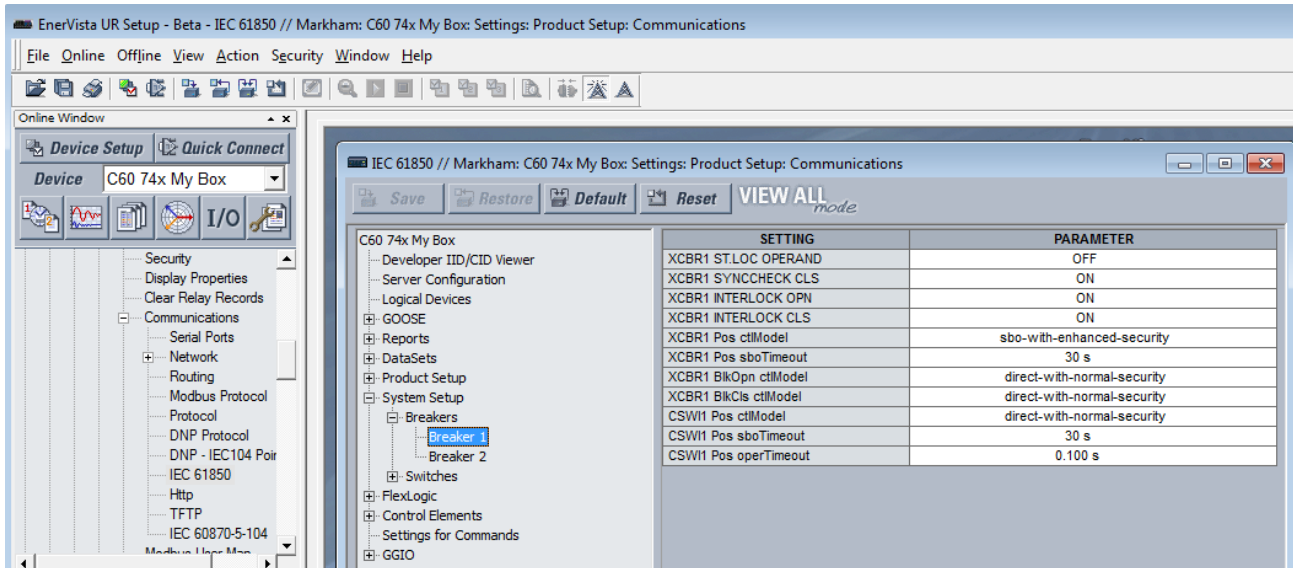
The EnerVista UR Setup software provides the interface to configure G30 settings for the IEC 61850 protocol. This section describes this interface. The software also supports import/export and merging of IEC 61850 Substation Configuration Language (SCL) files as documented in the UR Family Communications Guide.

The IEC 61850 protocol configuration settings cannot be accessed through the UR front panel and are instead accessible with the EnerVista software, via MMS query, read, and write services, or via 61850 SCL file transfer. Accordingly, whereas other settings are presented in this manual as they appear on the front panel, IEC 61850 settings are presented as they appear in the software. See the UR Family Communications Guide for MMS and SCL access. Note that if you update the IEC 61850 settings in the EnerVista software by writing to them by MMS while the corresponding IEC 61850 panel is open in EnerVista, you need to close then open the panel in EnerVista for the correct readings to display.

IEC 61850 protocol configuration settings are accessed through software panels that are selected either in the **Online Window** area (see figure) or the **Offline Window** area in the EnerVista software.

The EnerVista software also includes an interface that is compatible with firmware versions 5.0 to 7.2 to configure subscribers. Use the Simplified GOOSE Configurator in the Offline Window area.

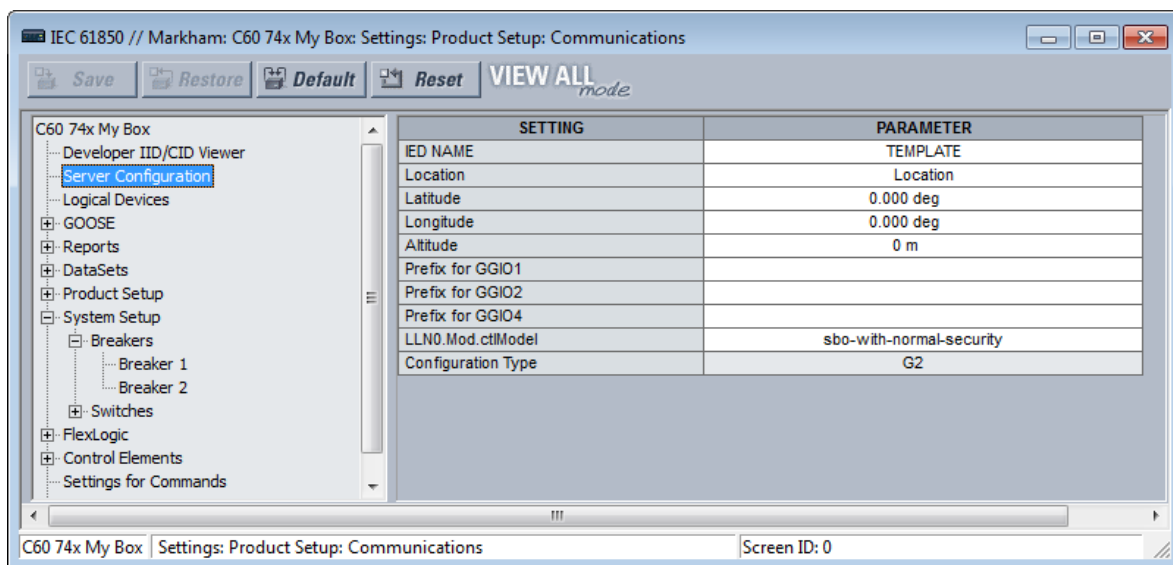
Figure 5-18: IEC 61850 protocol panel in EnerVista software (Edition 2)



5

The IEC 61850 window is divided into a navigation pane on the left and a settings panel on the right. You expand and click an option on the left to display its panel on the right. The following figure shows an example for Server Configuration. The **SETTING** column contains the names of the settings, and the **PARAMETER** column is used to enter the settings. Hovering the mouse over a setting name displays a tool-tip showing the 61850 information model name of the setting or its location in SCL files.

Figure 5-19: IEC 61850 panel (Edition 2)



Opening the IEC 61850 window while online causes the UR Setup software to retrieve and import an SCL file from the G30. This System Configuration Description (SCD) file contains all the settings in the UR at the time of the file request, both those that are mapped into the IEC 61850 information model (that is, the "public" sections) and those that are not in the model

(that is, the "private" section). The UR EnerVista Setup software imports all of these settings into the current session, not just those in the IEC 61850 window. To avoid loss of any unsaved setting changes made in other panels during the current session, all other panels for the G30 must be closed before the IEC 61850 panel can be opened, and the software prompts for this when applicable. Panels for other devices can be open concurrently to facilitate parameter coordination.

When CyberSentry security is enabled, editable settings depend on the user role logged in. For example, an Administrator and Engineer can change settings. If prompted for a "Settings password," it means the Administrator or Engineer password.

The **Restore** button restores settings in the window to their last saved values. The **Default** button reverts settings in the window to factory default values or Oscillography, Data Logger, or FlexLogic Equation Editor pre-configured values. The **Reset** button reverts all IEC 61850 settings to the factory default values, not just the current window. (In other settings windows, the button reverts settings in the window to factory default values.)

When a setting is enabled, its panel continues to read Disabled until relaunched. There is no polling capability to update automatically the IEC 61850 readings, so the panel needs to be closed then opened for the correct status to display. Good practice is to close any panel not in use because changes being made by other users too are reflected only upon relaunch of the panel.

Some of the IEC 61850 settings use floating point data, which guarantees accurate representation of real numbers up to seven digits. Numbers with more than seven digits are approximated within a certain precision. This can result in differences between what is entered and what is saved, and for example results in differences shown on a settings comparison report.

### Create CID and settings files

When the **Save** button is clicked in the online IEC 61850 window, UR Setup software prepares a configured IED description (CID) file containing all the settings of the UR and sends the CID file to the G30. Upon receipt, the G30 checks the CID file for correctness, going out of service, then back into service when the CID file is accepted. The software displays a message when the G30 is running the new settings, confirming successful transfer. This process can take a minute or so due to the amount of processing required by the software and the G30.

When the **Save** button is clicked in the offline IEC 61850 window, UR Setup software saves to local storage, for example the hard drive, a .urs file containing all settings of the UR.

### View IID/CID files

The file types are described as follows:

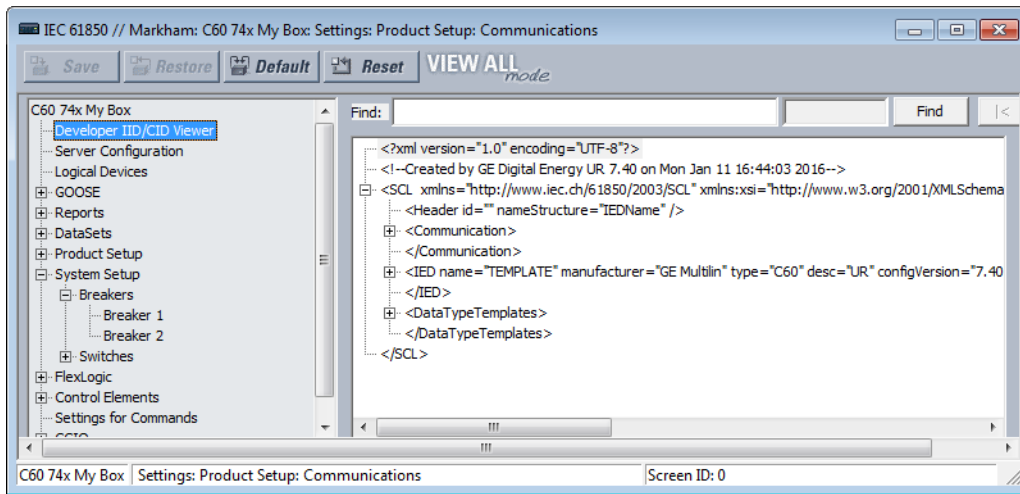
- IID — Instantiated IED capability description file — Actual settings on UR
- CID — Configured IED description file — Settings sent to the UR (may or may not contain the present settings)

The IID file type applies to IEC 61850 Edition 2 only.

IID and CID files are viewable. For example, after modifying settings in the IEC 61850 panels and clicking **Developer IID/CID Viewer** in the software, a CID file generates and an SCL Viewer shows the updated CID file content. There are no edit or save functions; use instead the Back Up and Restore Settings instructions later in this document to save the files.

Searches are case insensitive.

Figure 5-20: View CID settings file (Edition 2)



### Server configuration

The Server Configuration panel contains IEC 61850 settings relevant to the server functions of the IED implementation.

The path is **Settings > Product Setup > Communications > IEC 61850 > Server Configuration**.

The following settings are available, where <iedName> is a syntactic variable representing the present value of the IED NAME setting.

#### IED NAME

Range: 1 to 58 VisibleString characters

Default: TEMPLATE

The value entered sets the IED name used by IEC 61850 for the G30. An IED name unique within the network must be entered for proper operation. Valid characters are upper and lowercase letters, digits, and the underscore ( \_ ) character. The first character must be a letter.

The **IED NAME** and the **Product LD inst name** comprise the <LDName> for a product. The longest LD inst are "Master" and "System" at six characters, with Master being fixed and the others configurable with the configurable Logical device feature. So the IED NAME needs to be restricted to 58 characters to meet a 64 character limit.

#### Access Point

Range: S1, S2, S3

Default: S1

This setting applies to IEC 61850 Edition 1. It is the subnetwork.

#### Location

Range: 0 to 255 ASCII characters

Default: Location

The value entered sets the value of the data attribute <LDName>/LPHD1.PhyNam.location. This data attribute is provided by the protocol to allow the user to declare where the equipment is installed.

#### Latitude

Range: -90.000 to 90.000 degrees in steps of 0.001 degree

Default: 0.000 deg

The value entered sets the value of the data attribute <LDName>/LPHD1.PhyNam.latitude. This data attribute is provided by the protocol to declare the geographical position of the device in WGS84 coordinates -latitude. Negative values indicate a southern latitude. WGS refers to the world geodetic system, which is used in global positioning systems (GPS), and 84 is the current version of the standard.



**Longitude**

*Range: -180.000 to 180.000 degrees in steps of 0.001 degree*

*Default: 0.000 deg*

The value entered sets the value of the data attribute <LDName>/LPHD1.PhyNam.longitude. This data attribute is provided by the protocol to declare the geographical position of the device in WGS84 coordinates -longitude. Negative values indicate a western longitude.

**Altitude**

*Range: 0 to 10,0000 m in steps of 1 m*

*Default: 0 m*

The value entered sets the value of the data attribute <LDName>/LPHD1.PhyNam.altitude. This data attribute is provided by the protocol to declare the geographical position of the device in WGS84 coordinates - altitude.

**Prefix for GGIO1**

*Range for Edition 2: 0 to 11 VisibleString characters*

*Range for Edition 1: 0 to 6 VisibleString characters*

*Default:*

This setting sets the LN Prefix of the FlexLogic operand interface logical node GGIO1 that is described in the GGIO1 section later. Valid characters are upper and lowercase letters, digits, and the underscore (\_) character. The first character must be a letter. UR Setup software does not allow entry of a prefix that duplicates any other GGIO1 prefix that is used by the product, such as ConIn and ConOut.

**Prefix for GGIO2**

*Range for Edition 2: 0 to 11 VisibleString characters*

*Range for Edition 1: 0 to 6 VisibleString characters*

*Default:*

This setting sets the LN Prefix of the Virtual Inputs Interface logical node GGIO2 that is described in the GGIO2 section later. Valid characters are upper and lowercase letters, digits, and the underscore (\_) character. The first character must be a letter. UR Setup software does not allow entry of a prefix that duplicates any other GGIO2 prefix that is used by the product.

**Prefix for GGIO4**

*Range for Edition 2: 0 to 11 VisibleString characters*

*Range for Edition 1: 0 to 6 VisibleString characters*

*Default:*

This setting sets the LN Prefix of the FlexAnalog operand interface logical node GGIO4 that is described in the GGIO4 section later. Valid characters are upper and lowercase letters, digits, and the underscore (\_) character. The first character must be a letter. UR Setup software does not allow entry of a prefix that duplicates any other GGIO4 prefix that is used by the product.

**LLN0.ModctlModel**

*Range: status-only, direct-with-normal-security, sbo-with-normal-security*

*Default: sbo-with-normal-security*

This setting specifies the control service that clients must use to control the TEST MODE FUNCTION of the G30. An "on" control to <LDName>/LLN0.Mod changes TEST MODE FUNCTION to Disabled, an "on-blocked" control changes it to Forcible, and a "test/blocked" changes it to Isolated.

**Configuration Type**

*Range: G2, E3-2.0*

*Default: G2*

This setting is read only. It specifies the method used to describe GOOSE subscription configuration in SCL. See the UR Family Communications Guide for details. In the G2 mode, the CID file contains IED elements for IEDs subscribed to by this IED containing GOOSE subscription information. In the E3 2.0 mode, the CID file has only one IED element and GOOSE subscription information is coded in data objects in the standard LGOS logical node used to monitor reception of

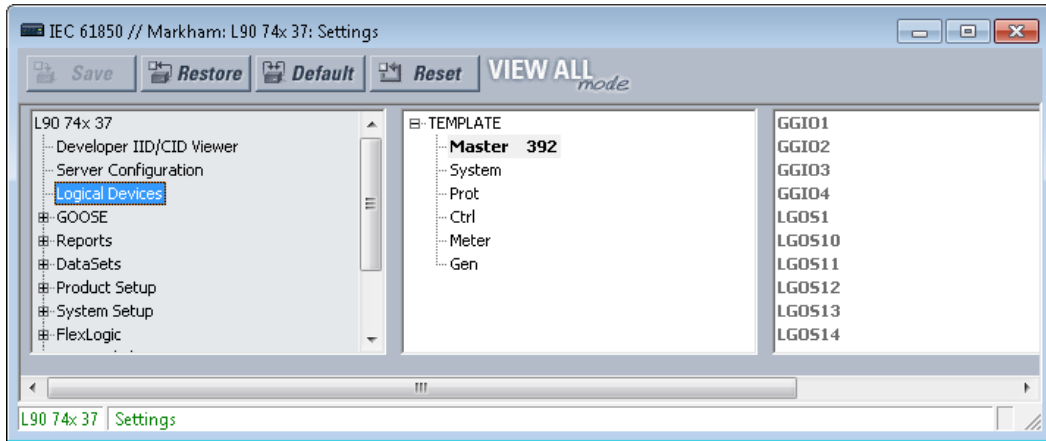
the subscribed GOOSE. UR 7.30 or later accepts either mode. The set value is for the entire EnerVista installation and is preserved between sessions. To change this global field, click **File > Preferences** and access the IEC 61850 panel; you do not need to be connected to the device.

### Logical devices

The Logical Devices panel contains IEC 61850 settings relevant to the configurable logical devices feature, wherein logical device naming can be reconfigured and logical nodes re-assigned.

The path is **Settings > Product Setup > Communications > IEC 61850 > Logical Devices**.

**Figure 5-21: Default IEC 61850 Logical Devices panel with devices middle and nodes right (Edition 2)**



5

To configure logical devices and nodes:

1. Right-click an entry and edit an existing device, add a new one, or move a logical node. The rest of this section explains the window and how to perform these actions.

The default logical device categories are as follows:

- **Master** — Communications, including GOOSE, reports, Remote I/O, Virtual Inputs, Modbus, DNP, and setting group control
- **System** — Power system devices: breakers, switches, CTs, VTs, and so on, including interfaces to these, such as AC inputs, contact I/O, transducer I/O, HardFiber I/O
- **Prot** — Protection and protection-related functions
- **Ctrl** — Control and monitoring functions
- **Meter** — Metering and measurement functions
- **Gen** — FlexLogic, Virtual Outputs, non-volatile latches, FlexElements, recording (for example oscillography), security, front panel, clock

For the Master logical device, the following logical nodes have fixed assignment:

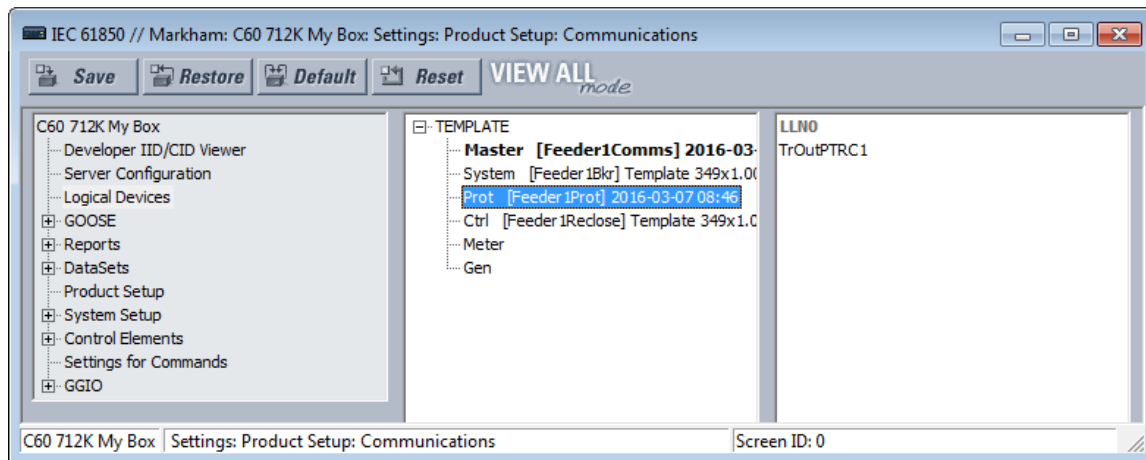
- The LLN0 in the Master logical device, which includes setting group, GOOSE and report control blocks, and datasets
- LPHD1 — Models common issues for physical devices
- GGI01 — For unmapped FlexLogic operands
- GGI02 — For Virtual Input control
- GGI03 — For RxGOOSE Inputs
- GGI04 — For unmapped FlexAnalog operands
- LGOS logical nodes — For GOOSE subscription



The Logical Devices panel has middle and right panes. The middle pane has a list of the instantiated logical devices in the sequence that they appear in SCL, with one device selected. The right pane has a list of the logical nodes presently assigned to the selected logical device in lexicographic order by logical node name.

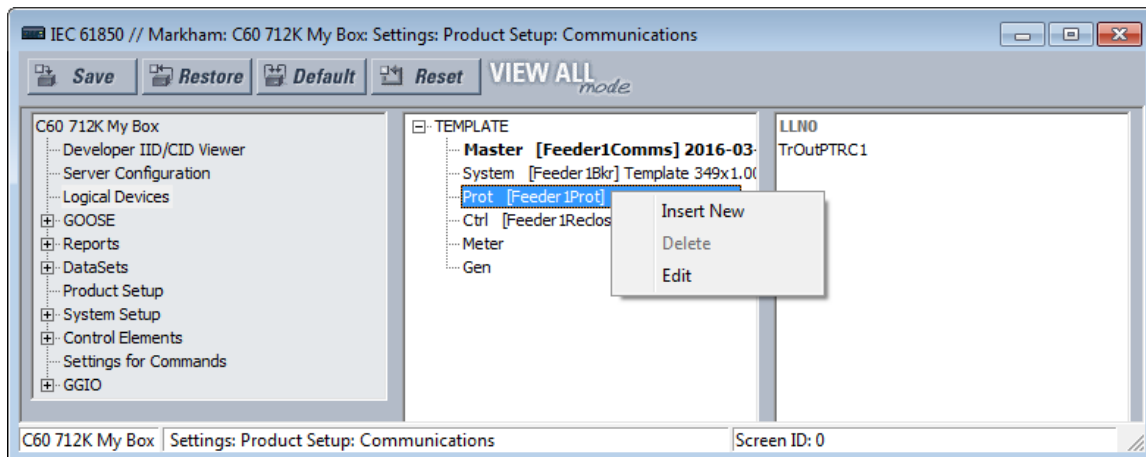
In the middle pane logical devices are shown with their product-related name, followed in brackets by their function-related IdName, and followed by the value of their confRev. In the following example, by right-clicking and editing, the Protection logical device has been set to instance name "Prot", the function-related name "Feeder1Prot" and the configuration revision "2016-03-07 08:46." The text is clipped on the right if the line is longer than the available width. The next paragraphs explain how to do this setup.

Figure 5-22: Protection logical node selected



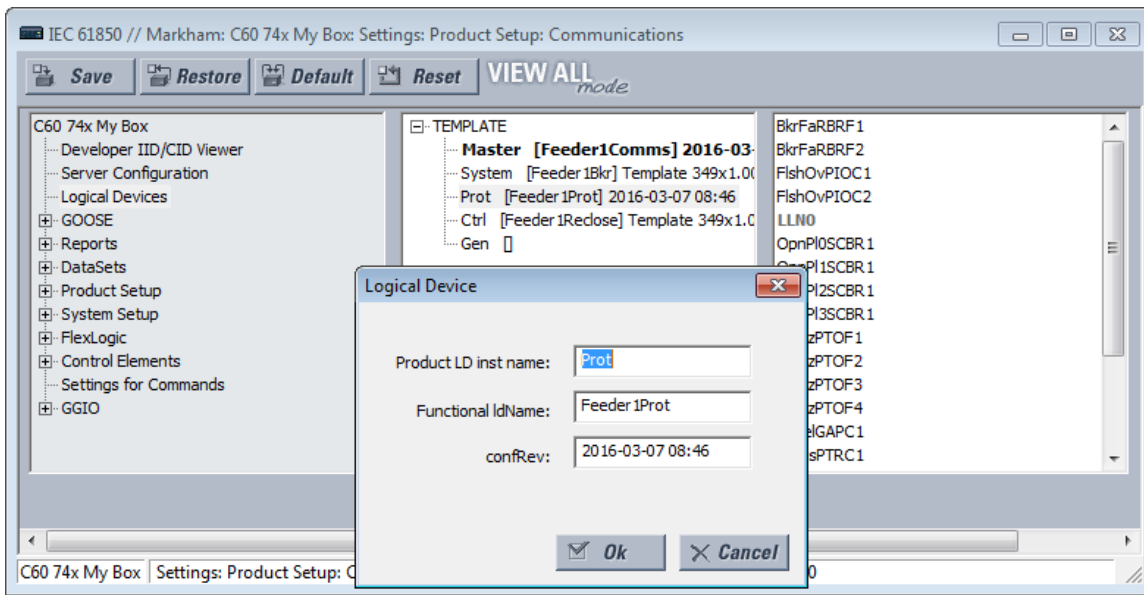
Right-clicking a logical device displays the menu that allows insertion of a new logical device immediately below the selected one, deletion of the selected logical device, or editing the selected logical device's parameters. The insert option is disabled and greyed-out if there are already 16 logical devices instantiated. The delete option is disabled and greyed-out if the selected logical device is Master or it contains any logical nodes other than LLNO.

Figure 5-23: Menu for logical node



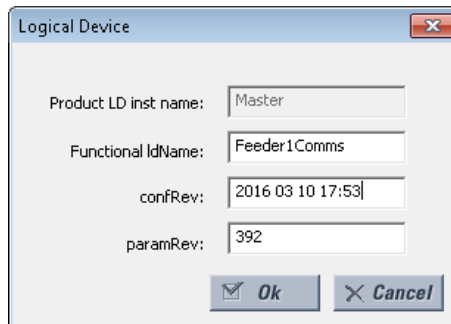
If the insert option is selected, or the edit option is selected for other than the Master logical device, a logical device parameters edit dialog opens.

Figure 5-24: Insert new logical node (Edition 2)



If the edit option is selected for the Master logical device, the **Product LD inst name** setting is not editable.

Figure 5-25: Edit logical node



When the **Ok** button is clicked, the entered values for **Product LD inst name** and **Functional IdName** are checked for uniqueness within the UR, and they are updated in the pane.

The settings are explained as follows, where <iedName> is a syntactic variable representing the present value of the IED NAME setting. When adding or editing a logical device entry, these are the fields that need to be completed.



Customized logical nodes are not saved in the URS file.

**Product LD inst name**

*Range: 1 to 64 VisibleString characters*

*Default: as per the following table*

Each logical device has this setting. The value is fixed at "Master" in the first logical device and configurable in all others. Valid characters are upper and lowercase letters, digits, and the underscore ( \_ ) character. The first character must be a letter. The entered value sets the logical device inst name. Each logical device inst name is required to be unique within the device, and it cannot be blank. Also, if the corresponding functional IdName setting is blank, the concatenation of the

IED name and the logical device inst name must form an LDName that is unique within the network for proper operation. It is recommended that the length of the IED NAME plus the length of this setting be not greater than 64 to respect the requirements of IEC 61850 7 2:2010 22.2 for LDName.

The factory default configuration is for six logical devices with Product LD inst name settings and logical node assignments as per the following table.

**Table 5-10: Factory default logical nodes**

Default logical device inst name	Contains logical nodes modeling...
Master (root logical device; name is fixed)	communications, including GOOSE, reports, Remote I/O, Virtual Inputs, Modbus, DNP, and so on. Setting group control. This is the root logical device. To comply with IEC 61850 7 1 Ed2 clause 6.4.5.1, all group L logical nodes (logical nodes with class names begin with "L"), except LLN0, belonging to this IED are in this logical device.
Protection (Prot)	protection functions
Control (Ctrl)	control and monitoring functions
System	power system devices: breakers, switches, CTs, VTs, and so on, including interface to these such as AC inputs, contact I/O, transducer I/O, HardFiber I/O
Metering (Meter)	metering and measurement, including Signal Sources
General (Gen)	FlexLogic, virtual outputs, non-volatile latches, FlexElements, FlexMath, recording (for example oscillography), security, front panel, clock

### Functional IdName

*Range: 0 to 64 VisibleString characters*

*Default: empty string*

Each logical device has this setting. The value is configurable in all logical devices. Valid characters are upper and lowercase letters, digits, and the underscore (\_) character. If the number of characters entered is greater than zero, the setting sets the value of the function-related name used in communications. If an IdName is entered, it must form an LDName that is unique within the network for proper operation. The standard recommends choosing this name according to IEC 81346-1. If the number of characters entered is zero, no function-related name is defined.



**NOTE**

Throughout the remainder of this IEC 61850 section, <LDName> is a syntactic variable representing the present LDName of the master logical device. In other contexts LDName can refer to some other logical device. Depending on its context, <LDName> can be a product-related name or a function-related name.

### configRev

*Range: 0 to 255 ASCII characters*

*Default:*

This data attribute is provided by the protocol to declare changes to the semantic of the data model of the UR. The intent is that the user changes Master configRev each time that the semantic or data model changes, so that clients can readily detect the change. A semantic change is a logical node getting a new semantic use; for example, an instance of logical node CSWI is now serving a different physical switch, or an instance of a logical node PDIS is now used for another zone. A data model change is a change in the presence of logical nodes, data objects, data attributes, or instance names.

The scope of Maser configRev is the entire relay configuration, as the Master logical device is the root logical device. Similar settings are provided for the other logical nodes; the scope of these other configRev settings is limited to the corresponding logical device configuration.

### paramRev

*Range: -2,147,483,648 to 2,147,483,647*

*Default: 0*

The configurable data attribute paramRev has a scope that includes the entire device, and thus is modified whenever any setting in the device changes. The UR increments the value of paramRev by one whenever one or multiple setting changes occurs in one Modbus write request by any means (front panel, Modbus, or MMS) other than by SCL file

download. Incrementing occurs whether or not the setting is represented in the information model. When a UR device or EnerVista UR Setup accepts an SCL file, paramRev is set to the value in that SCL file. When EnerVista UR Setup changes one or more settings, and prepares an SCL file, it increments paramRev to the next higher multiple of 10 000.



Each logical device has a name: LDName. (Note the upper case LD.) LDName has both a product-related form and a function-related form as per IEC 61850 6:2009 8.5.3.

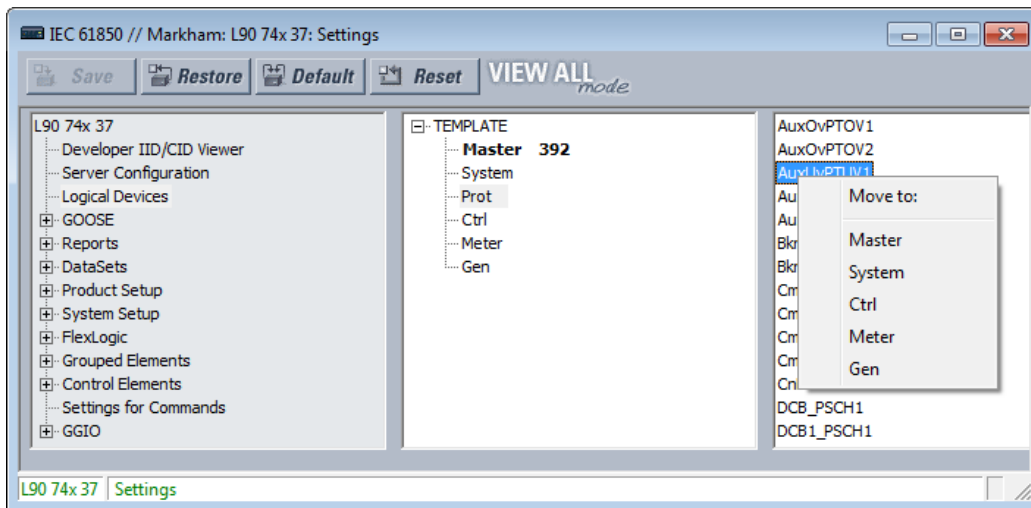
SCL files invariably use the product-related form of LDName. The product-related form is the concatenation of the IED name of the device and the individual logical device's inst name. The IED name is the value of the "IED NAME" setting on the Server Configuration panel, and the logical device inst names are each the value of the corresponding "Product LD inst name" setting here. The "Product LD inst name" of the first logical device is fixed at "Master".

Communications use the function-related form of LDName if a function-related name is defined, otherwise communications use the product-related name. The function-related name is the value of the corresponding "Functional ldName" setting if this setting is not empty, if empty the function-related name is not defined.

In SCL, the function-related name is specified by the LDevice element attribute ldName (note the lower case ld). Absence of this attribute indicates the function-related name is not defined. In SCL the product-related name is specified by the name attribute of the IED element and the inst attribute of the LDevice element.

In the right pane, logical nodes assigned permanently to the Master logical device and LLN0 in all logical devices are greyed-out as shown earlier. These are not movable. Any other logical node can be dragged to any of the logical devices in the middle pane, which causes that logical device to be re-assigned to that logical device. Right-clicking a logical node device displays a menu that lists the logical devices that this logical node can be moved to. Clicking one of these re-assigns the logical node. Other common keyboard and/or mouse action can be used to select one or more logical nodes and move the selected nodes together.

Figure 5-26: Move logical node (Edition2)



**GOOSE**

The path is **Settings > Product Setup > Communications > IEC 61850 > GOOSE**.

**Support for Routable GOOSE**

Routable GOOSE (R-GOOSE) is supported in firmware release 7.4 and later for IEC 61850 Edition 2. Routable GOOSE allows UR and other devices to be located in separate networks. Encryption/decryption of messages is performed by a separate gateway device. Messages are routed using a separate router, using IP addresses.

Note the following behavior:

- A v7.4 device can send an R-GOOSE message to another v7.4 device when both have R-GOOSE active as the protocol
- A v7.4 device can send a GOOSE message to another v7.4 device when both have GOOSE active as the protocol

- A v7.4 device cannot send an R-GOOSE message to non-R-GOOSE devices, such as v7.3 or v5.9 UR device
- UR devices with firmware below v7.3 can send a GOOSE message to a v7.4 device that has GOOSE as the active protocol



R-GOOSE is available through the IEC 61850 software option. If R-GOOSE security is required, the CyberSentry software option also must be purchased.

## TxGOOSE

IEC 61850 GOOSE is an efficient method for simultaneous high-speed delivery of generic substation event information by a publishing device to more than one subscribing device. A TxGOOSE is a UR element implementing a single IEC 61850 GOOSE message publishing service. The subscribing function in URs is performed by RxGOOSE elements, as described in the next section. Each UR with IEC 61850 order code options has 16 TxGOOSE elements. Each TxGOOSE can either use the original format specified in IEC 61850 8 1:2011 or the routable GOOSE (R-GOOSE; IEC 61850 Edition 2) format specified in IEC TR 61850-90-5:2012. Each TxGOOSE element can publish the values of up to 64 attributes of the IEC 61850 nodes in the UR.

Published TxGOOSE messages configured in the EnerVista UR Setup software can be subscribed by and the published operand values understood by other UR devices. Furthermore, they can be subscribed to and understood by any device of any manufacturer that implements the IEC 61850 edition 1.0 or 2.0 GOOSE subscription mechanism. The messages are published with a multicast address so that the network sends the messages to all devices; any number of devices that want to subscribe can.

For wide area protection, control, and monitoring schemes, R-GOOSE wraps the proven original format GOOSE in IP/UDP to multicast (or unicast) the data over a Wide Area Network (WAN). Sample applications are Wide area Remedial Action Scheme (RAS) and Under Voltage/ Frequency Load Shedding Schemes (UVLS/UFLS). R GOOSE uses IGMPv3 (Internet Group Management Protocol version-3, RFC 3376) for multicasting.

The entities whose values are published in GOOSE messages are known as members. The members are itemized in an ordered list known as a data set. Each TxGOOSE can use any one of the configured data sets. (See the DataSets section later for details.) The performance of a TxGOOSE is determined by its dataset. Booleans in fast GOOSE datasets are designed for the TT6 transfer time class (3 ms), while Booleans in the Normal datasets are designed for the TT3 class (100 ms). Due to the significant amount of CPU time required to compose a TT6 TxGOOSE message and the limited amount of time allowed by the TT6 class, at most four of these can be configured in a given UR. So only four fast GOOSE are allowed to be configured, and the UR software has a check to disallow the use of more than four fast datasets in GOOSE. If six fast datasets are configured outside of UR software and the file sent directly to the relay, the relay rejects the file. The design does allow six fast datasets to be used in report control blocks, which allows fast scanned data in reports.

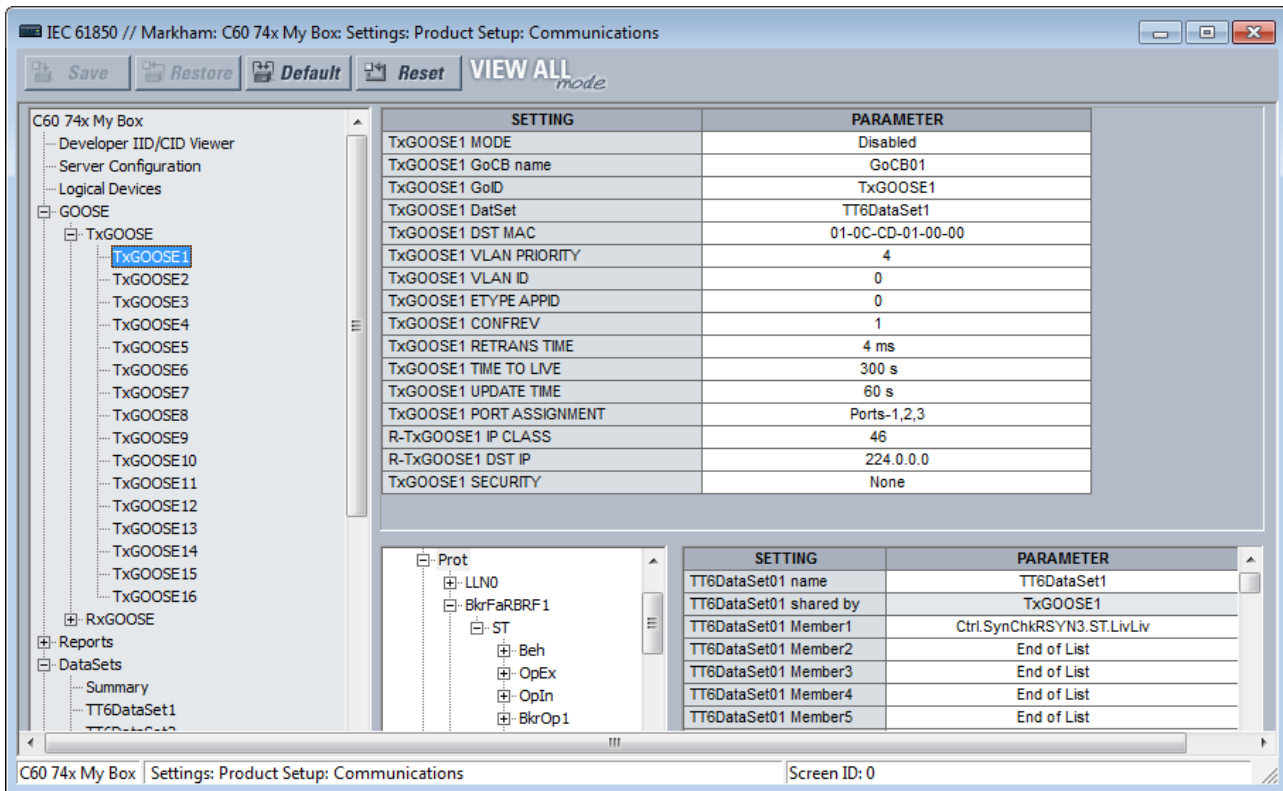
Each enabled TxGOOSE transmits its message whenever a value change is detected in one or more of its members. If the changed value is a Boolean in a fast dataset, then the change detect occurs in the TT6 detection time of 3 ms or less. If the member is an analog value in a fast dataset, the change detect occurs in the TT3 time of 100 ms. In Normal GOOSE Datasets, change detection for all dataset members occurs in the TT3 time of 100 ms. To guard against the possibility that such a message is lost in the network before it reaches all subscribers, the message is quickly retransmitted several times. To allow subscribers to verify that their link to the publisher and the publisher itself are healthy, each message is also retransmitted periodically even while the values are unchanging. These latter messages are known as heartbeat messages, while the former are known as event messages. Heartbeat messages also provide means for a subscriber newly online to receive the published values in the absence of an event.

The details of TxGOOSE message construction are contained in the UR Family Communications Guide. Knowledge of these details is not required to configure GOOSE.

The UR does not implement the Fixed-Length encoded GOOSE messages option specified in IEC 61850-8-1:2011 clause A.3; the UR always uses the ASN.1 Basic encoding rules (as specified in ISO/IEC 8825-1) as specified in IEC 61850 edition 1.0 and as optional in IEC 61850 edition 2.0.

Navigate to **Settings > Product Setup > Communications > IEC 61850 > GOOSE > TxGOOSE > TxGOOSE1** to access the settings for the first TxGOOSE. The settings and functionality for the others are similar.

Figure 5-27: IEC 61850 TxGOOSE panel (Edition 2)



5

A data set needs to be set up and selected in the **TxGOOSEx DataSet** field for all content to display.

When saving changes, when a "dataset member is empty" message displays, you need to set the member in the bottom right of the window.

**TxGOOSE1 MODE**

Range for Edition 2: Disabled, GOOSE, R-GOOSE

Range for Edition 1: Disabled, GOOSE

Default: Disabled

When set to Disabled, TxGOOSE1 messages are not published. When set to GOOSE, TxGOOSE1 messages are published in IEC 61850 8 1:2011 GOOSE format. When set to R-GOOSE, TxGOOSE1 messages are published in Routable GOOSE format according to IEC 61850 90-5, and the **TxGOOSE1 DST MAC** address is set to 00 00 00 00 00 00 and cannot be changed.

**TxGOOSE1 GoCB name**

Range: 0 up to 32 VisibleString characters

Default: GoCB01

The entered value sets the GOOSE control block (GoCB) name value for TxGOOSE1.

An ObjectReference to the control block, which consists of the concatenation of the string "<LDName>/LLN0." and the control block name, is published in the gocbRef field of TxGOOSE1 messages and is used by subscribers to discriminate TxGOOSE1 messages from other GOOSE messages. <LDName> is a syntactic variable that is set to the value of setting Master functional IdName if one or more characters have been entered to that setting, otherwise the value of setting IED NAME suffixed with "Master".

**TxGOOSE1 GoID**

*Range for Edition 2: 0 to 129 VisibleString characters*

*Range for Edition 1: 0 to 65 VisibleString characters*

*Default: TxGOOSE1*

The entered value sets the goID value published in TxGOOSE1 messages, and can be used by subscribers to discriminate the TxGOOSE1 messages from other GOOSE messages. Special characters are not allowed, such as <, >, &, ' , and " .

**TxGOOSE1 DataSet**

*Range: None, TT6DataSet1, TT6 DataSet2, ... TT3DataSet01, TT3 DataSet02, ...*

*Default: None*

This setting selects the published data set using the UR Setup software designator for the data set. If None is selected, no TxGOOSE1 messages are sent.

The IEC 61850 name of the data sets are configured in the Datasets panel, as described later.

Some datasets are designed for the TT6 transfer time class (3 ms), while others are designed for the TT3 class (100 ms). The performance of a TxGOOSE is determined by its dataset. Use TT6 datasets for trips and blocking applications, TT3 datasets for slow automatic interactions. The 61850 name of the datasets are configured in the Datasets panel.

An ObjectReference to the data set, which consists of the concatenation of the string "<LDName>/LLN0." and the data set name, is published in the datSet field of TxGOOSE1 messages and can be used by subscribers to discriminate TxGOOSE1 messages from other GOOSE messages. <LDName> is a syntactic variable that is set to the value of setting Master functional ldName if one or more characters have been entered to that setting, otherwise the value of setting IED NAME suffixed with "Master".

To configure a DataSet, select it at the top of the window from the drop-down list. In the lower part of the window, drag and drop configuration items to the right side. Dataset members configured here affect other Report or TxGOOSE control blocks that use the same DataSet.

The performance of the TxGOOSE is determined by the performance of the selected dataset. When the selection is TT3DataSet01, TT3DataSet02, ... it is possible that transient events can be missed.

**TxGOOSE1 DST MAC**

*Range: any 12 digit hexadecimal number*

*Default: 01-0C-CD-01-00-00*

When the **TxGOOSE1 MODE** setting is R-GOOSE, the **TxGOOSE1 DST MAC** address is set to 00 00 00 00 00 00 and cannot be changed. Otherwise, the value entered here sets the Ethernet destination Media Access Control (MAC) address in published TxGOOSE1 messages. As the standard requires that the address have the multicast bit set TRUE, that is to say the second digit is set to an odd number, messages transmitted have the multicast bit set TRUE no matter its value in this setting.

The destination MAC address can be used by the network to restrict message delivery to selected devices that need to receive them, reducing network load. This address also can be used by hardware in receiving devices to filter out messages that are of no interest to them, reducing processor burden. Different filtering algorithms are implemented by different devices. The standard recommends that the algorithm used by hardware of the receiving device be considered when assigning destination multicast addresses.

Subscribers can use this address to discriminate TxGOOSE1 messages from other GOOSE messages.

**TxGOOSE1 VLAN PRIORITY**

*Range: 0, 1, 2, 3, 4, 5, 6, 7, 5-4, 6-4, 6-5, 7-4, 7-5, 7-6*

*Default: 4*

When the value entered is 0, 1, 2, 3, 4, 5, 6, or 7, the User Priority value in the IEEE 802.1Q VLAN tag included in published TxGOOSE1 messages is set to that value. When one of the two-digit values is entered, the dynamic priority feature is selected: the first event message has the User Priority value of the first digit, and User Priority is decremented in each following message until reaching the value of the second digit. For instance, if the selected value is 7-5, then the User Priority values in successive messages beginning with the message triggered by an event is 7, 6, 5, 5, 5, 5, and so on. Do not make a dynamic priority selection when standard behavior is required.

Network devices can forward a message with a higher priority value before a message with a lower priority value, which speeds delivery of high-priority messages in heavily loaded networks. The standard recommends that higher-priority messages, such as GOOSE, have priority values in the range of 4 to 7.



**TxGOOSE1 VLAN ID**

*Range: 0 to 4095 in steps of 1*

*Default: 0*

The value entered sets the VID value in the IEEE 802.1Q VLAN tag included in published TxGOOSE1 messages. VID can be used by network devices to direct messages to only selected devices, reducing network burden. VID values of 0 and 1 are assigned by IEEE 802.1Q to other functions and are not to be used for GOOSE.

**TxGOOSE1 ETYPE APPID**

*Range: 0 to 65535 in steps of 1*

*Default: 0*

The value entered sets the APPID value in published GOOSE messages and can be used by subscribers to discriminate TxGOOSE1 messages from other GOOSE messages.

The standard reserves the value range 0 to 16383 for GOOSE Type 1 (Fast messages), and reserves the value range 32768 to 41151 for GOOSE Type 1A (Trip messages). Some subscribers can process messages in the Type 1A range faster than messages in the Type 1 range. The standard reserves the default value (0) to indicate lack of configuration. The standard strongly recommends unique, source-orientated APPIDs within a given system.

**TxGOOSE1 CONFREV**

*Range: 0 to 4294967295 in steps of 1*

*Default: 1*

The entered value sets the confRev value in published GOOSE messages and can be used by subscribers to discriminate TxGOOSE messages of the expected configuration revision from messages of a different revision. The standard requires that CONFREV be incremented each time the members or the order of the members published is changed. The standard states that the value of 0 is reserved.

**TxGOOSE1 RETRANS TIME**

*Range: 0 to 100 ms in steps of 1 ms*

*Default: 4 ms*

If the entered time is non-zero, when a member value change is detected, four event transmissions are sent, then heartbeat transmissions resume. The interval between the first and second event transmissions, and between the second and third, is the time set here. The interval between the third and the fourth event transmission is double the set time. If the entered time is zero, only a single event transmission occurs, then heartbeat transmissions resume.

**TxGOOSE1 TIME TO LIVE**

*Range: 1 to 60 s in steps of 1 s*

*Default: 60 s*

The value entered sets the timeAllowedtoLive value in published TxGOOSE1 messages. The standard requires subscribers to assume a failure has occurred when another TxGOOSE1 message is not received within the published timeAllowedtoLive time.

Base this setting on the **TxGOOSE UPDATE TIME** and the tolerable number of contiguous message delivery misses. For example, if the heartbeat time is 10 s, and missing up to three successive messages is tolerable, make the setting  $10 * 3 + 1 = 31$  s. The extra second is to ensure that arrival of the third heartbeat transmission beats the timeAllowedtoLive timer.

In the imported CID file, if the TxGOOSE1 TIME TO LIVE is greater than 60 seconds, clamp the setting value to 60 seconds and an information log is provided in SCL log.

**TxGOOSE1 UPDATE TIME**

*Range: 1 to 59 s in steps of 1 s*

*Default: 30 s*

This setting specifies the time interval between heartbeat messages, meaning messages that are sent periodically while no events are detected.

**TxGOOSE1 PORT ASSIGNMENT**

*Range: Disabled, Port-1; Port-2; Port-3; Ports-1,2; Ports-2,3; Ports-1,3; Ports-1,2,3*

*Default: Ports-1, 2, 3*

This setting applies to IEC 61850 Edition 2.



This setting specifies the Ethernet ports for transmission of TxGOOSE1. When set to disabled, TxGOOSE1 messages are not transmitted on any port no matter the state of GoEna. When set to Port-1, TxGOOSE1 is published over Ethernet Port-1 only; while selecting Ports-1, 3 option, the same TxGOOSE1 is published to both Ports 1 and 3; and similarly if set to Ports-1, 2, 3, all ports publish TxGOOSE1.



When setting **PRT2 REDUNDANCY** to Failover or to PRP, the TxGOOSE 1 port assignment needs to be set to ports 2 and 3 (Ports-2,3).

NOTE

Also, Port 3 configuration in the CID file is ignored. The Port 3 ConnectedAP elements has no meaning, as ports 2 and 3 use the port 2 MAC address, IP address, and mask.

### R-TxGOOSE1 IP CLASS

*Range: 0 to 256 in steps of 1*

*Default: 46*

This setting applies to IEC 61850 Edition 2.

When the **TxGOOSE1 MODE** setting is other than R-GOOSE, the value of this setting is not used. Otherwise this setting selects the IPv4 Differentiated Services Code Point-DSCP (formerly called TypeOfService-TOS) value. This value provides priority routing, when supported in the routers. The default value is for Expedited Forwarding (101110B, 46 or 2EH).

### R-TxGOOSE1 DST IP

*Range: 0.0.0.0 to 255.255.255 in steps of 1*

*Default: 224.0.0.0*

This setting applies to IEC 61850 Edition 2.

When the **TxGOOSE1 MODE** setting is other than R-GOOSE, the value of this setting is not used. Otherwise this setting specifies destination IP address for the R-TXGOOSE1 that is entered in Standard IPV4 address format. The destination IP address needs to be a valid multicast or unicast IP address. The value specified in this setting is mapped to IPv4 header 32 bit field for Destination IP Address while publishing R-GOOSE1.

The default IP address 224.0.0.0 is reserved, and hence not a valid multicast IP address.

The source IP address is that of the UR port from which the R-GOOSE messages are transmitted.

### R-TxGOOSE1 SECURITY

*Range: None, Signature, SignatureAndEncryption*

*Default: None*

This setting applies to IEC 61850 Edition 2.

This setting specifies level of security (authentication/encryption) used for TxGOOSE1. None specifies no security mechanisms are to be used. Signature specifies only signature (no encryption) is to be used. SignatureAndEncryption specifies that both signature and encryption are to be used.

## RxGOOSE

Navigate to **Settings > Product Setup > Communications > IEC 61850 > GOOSE > RxGOOSE > RxGOOSE Messages**.

IEC 61850, GOOSE is an efficient method for simultaneous high-speed delivery of the same generic substation event information by a publishing device to more than one subscribing device. An RxGOOSE is a UR element implementing a single IEC 61850 GOOSE message subscribing service. The publishing function in URs is performed by TxGOOSE elements, as described in the previous section.

Each UR with the IEC 61850 order code option has 64 RxGOOSE elements. Each RxGOOSE element can subscribe to GOOSE messages from a specified publisher. Each RxGOOSE can either use the original format specified in IEC 61850 8 1:2011 or the routable GOOSE (R-GOOSE; IEC 61850 Edition 2) format specified in IEC TR 61850-90-5:2012. Subscribed message members can be DataObjects, SubDataObjects, DataAttributes or SubAttributes. In E2-2.0 mode members are restricted to basic types BOOLEAN, FLOAT32, INT32, Dbpos, TimeStamp or Quality. Each subscribed message can contain up to 64 values. A member can be a structure containing several values; note that it is the number of values rather than the number of members that are limited to 64.

GOOSE messages from any device of any manufacturer that implements the IEC 61850 Edition 1.0 or 2.0 GOOSE publish service or the 61850-90-5 R-GOOSE service (IEC 61850 Edition 2) can be subscribed to. The UR accepts both the variable length encoded GOOSE messages specified IEC 61850 8 1:2004 and the Fixed-Length encoded GOOSE messages as specified in IEC 61850 8 1:2011 clause A.3.

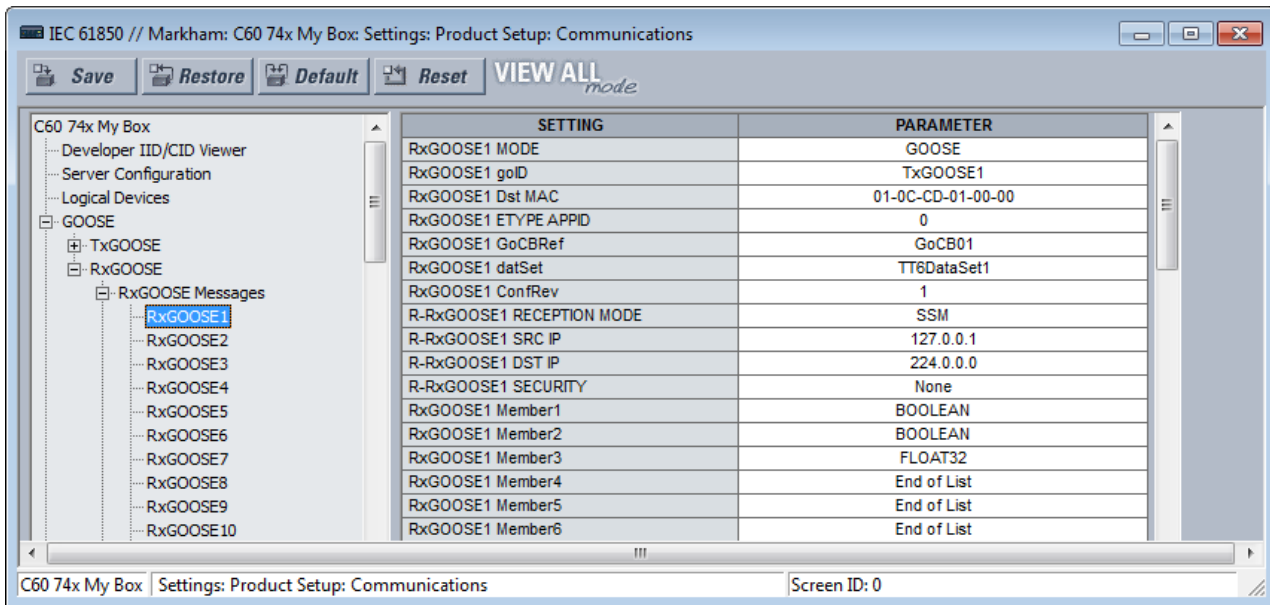
Each enabled RxGOOSE monitors for interruption of the GOOSE messages it subscribes to based on the value in the timeAllowedtoLive field of the last message received. If a new message is not received within that time interval, the RxGOOSE assumes that connectivity is lost. FlexLogic operands (for example RxGOOSE1 On, RxGOOSE1 Off) reflect the status of each RxGOOSE connectivity. An RxGOOSE connection is also considered lost after the UR finishes restart until a message is received. While any RxGOOSE connectivity is lost, a common RxGOOSE Fail self-test is activated.

Messages that contain the value true in the ndsCom field are never accepted. Messages that contain the value true in the simulation field (test field in edition 1.0 messages) are accepted only when the UR **Test Mode Function** setting is set to Forcible or Isolated.

RxGOOSE messages can be received through any UR Ethernet port.

Navigate to **Settings > Product Setup > Communications > IEC 61850 > GOOSE > RxGOOSE > RxGOOSE Messages > RxGOOSE1** to access the settings that specify the messages to be accepted by the first RxGOOSE element. The settings and functionality for the other RxGOOSE are similar. The following settings are available. They allow RxGOOSE1 to recognize the GOOSE messages it is to accept. Most of these settings are automatically configured by UR Setup software when an association to an RxGOOSE Boolean Input, RxGOOSE DPS Input, and/or RxGOOSE Analog Input is made as described in the sections following this. For IEC 61850 Edition 2, settings **R-RxGOOSE1 RECEPTION MODE**, **R-RxGOOSE1 SECURITY**, and **R-RxGOOSE SRC IP** need to be manually completed as the information is not contained in publisher SCL.

Figure 5-28: IEC 61850 RxGOOSE Messages panel (Edition 2)



**RxGOOSE1 MODE**

Range for Edition 2: GOOSE, R-GOOSE

Range for Edition 1: GOOSE

Default: GOOSE

When set to GOOSE, TxGOOSE1 messages are published in IEC 61850 8 1:2011 GOOSE format. When set to R-GOOSE, TxGOOSE1 messages are published in Routable GOOSE format according to IEC 61850 90-5. When set to R-GOOSE, the **R-RxGOOSE DST IP** needs to be a valid multicast or unicast IP address.

**RxGOOSE1 goID**

*Range: 0 to 129 VisibleString characters*

*Default: empty string*

If the entered value has one or more characters, the goID field of incoming GOOSE messages must exactly match this value for the message to be accepted as a valid RxGOOSE1 message. If the entered value is the empty string, RxGOOSE1 does not check the value received in the goID field. Special characters are not allowed, such as <, >, &, ' , and " .

If the publisher is a UR 7.3x series device, this setting needs match the value of the publisher's **TxGOOSE GoID** setting.

**RxGOOSE1 Dst MAC**

*Range: any 12 digit hexadecimal number*

*Default: 01-0C-CD-01-00-00*

When the **RxGOOSE1 MODE** setting is R-GOOSE, the value of this setting is not used, the destination Media Access Control (MAC) address for RxGOOSE1 messages is calculated based on the **RxGOOSE DST IP** address. Otherwise, set this setting to the MAC address of the publisher. Only received GOOSE messages having a MAC address equal to this value are accepted as valid RxGOOSE1 messages. An entered address of zero disables RxGOOSE1.

If the publisher is a UR series 7.3x device, the setting needs to match the value of the publisher's **TxGOOSE DST MAC** setting.

**RxGOOSE1 ETYPE APPID**

*Range: 0 to 65535 in steps of 1*

*Default: 0*

If the value entered is non-zero, the APPID field of incoming GOOSE messages must exactly match this value for the message to be accepted as a valid RxGOOSE1 message. If the value entered is zero, RxGOOSE1 does not check the value received in the APPID field.

If the publisher is a UR series 7.3x device, the setting needs to match the value of the publisher's **TxGOOSE ETYPE APPID** setting.

**RxGOOSE1 GoCBRef**

*Range: 0 to 129 alphanumeric, underscore, slash and period characters, beginning with an alpha character*

The gocbRef field of incoming GOOSE messages must match this value for the message to be accepted as a valid RxGOOSE1 message. If the entered value is the empty string, RxGOOSE1 is disabled. If not the empty string, the entry needs to be an ACSI ObjectReference to the publishing control block in the format:

<LDName>/LLN0.<GoCBName>

where <LDName> is the function-related name if the logical device containing the publishing control block has "ldName" configured, otherwise the product-related name of that logical device, and <GoCBName> is the name of the publishing control block.

The G30 translates the ACSI format required for this setting to the MMS format used in GOOSE messages:

<LDName>/LLN0\$GO\$<GoCBName>

If the publisher is a UR 7.3x or 7.40 series device, <LDName> is the value of the publisher's Master functional ldName setting if that setting is not empty, otherwise it is the value of the publisher's IED NAME suffixed with "Master". If the publisher is a UR 7.3x series device, <GoCBName> is "GoCB" suffixed with the two digit TxGOOSE instance number, for example "GoCB01". If the publisher is a UR 7.40 series device, <GoCBName> is as specified earlier in the TxGOOSE section of this chapter.

**RxGOOSE1 datSet**

*Range: 0 to 32 alphanumeric and underscore characters, beginning with an alpha character*

*Default: empty string*

If the entered value has one or more characters, the datSet field of incoming GOOSE messages must exactly match this value prefixed by <LDName>/LLN0\$ for the message to be accepted as a valid RxGOOSE1 message. <LDName> is as specified in the RxGOOSE GoCBRef setting above. If the entered value is the empty string, RxGOOSE1 does not check the value received in the datSet field.

If the publisher is a UR 7.3x series device, set this setting to the value of the publisher's DataSetxx name setting, where xx is the instance number of the data set selected by the publisher's **TxGOOSE datSet** setting. If the publisher is a UR 7.40 series device, datSet is as specified in the DataSets section of this chapter.

**RxGOOSE1 ConfRev**

*Range: 0 to 4294967295 in steps of 1*

*Default: 1*

If the value entered is non-zero, the confRev field of incoming GOOSE messages must exactly match this value for the message to be accepted as a valid RxGOOSE1 message. If the entered value is zero, RxGOOSE1 does not check the value received in the confRev field.

If the publisher is a UR 7.3x series device, set this setting to match the value of the publisher's **TxGOOSE ConfRev** setting.

**R-RxGOOSE1 RECEPTION MODE**

*Range: SSM, ASM, Unicast*

*Default: SSM*

This setting applies to IEC 61850 Edition 2.

When the **RxGOOSE1 MODE** setting is other than R-GOOSE the value of this setting is not used. Otherwise it selects the R-GOOSE reception mode.

**R-RxGOOSE RECEPTION MODE** specifies the **R-RxGOOSE DST IP** range. When set to SSM, **R-RxGOOSE DST IP** must be in the range of 232.0.0.1 to 232.255.255.255. When set to ASM, **R-RxGOOSE DST IP** must be in the range of 224.0.0.1 to 239.255.255.255, excluding the SSM range. Note that the SSM range is inside the ASM range and therefore the ASM use excludes the SSM range. The default destination IP address 224.0.0.0 is reserved, and hence not a valid multicast IP address.

The reception modes are related to Layer-3 R-GOOSE reception from routers/WAN. The subscription to multicasting of R-GOOSE is supported using IGMP Protocol Independent Multicast (PIM). It is made available in either Source Specific Multicast (SSM) mode or Any Source Multicast (ASM) mode. Unicast (over UDP) mode can also be used. In case of multicasting (IGMPv3 based SSM or ASM), the R-GOOSE subscriber device requests the Last Hop Router (LHR) to subscribe to a specific multicasting group.

If the publisher is using a unicast destination IP address for this R-GOOSE, then set **R-RxGOOSE1 RECEPTION MODE** to Unicast. Otherwise set **R-RxGOOSE1 RECEPTION MODE** to the SSM or ASM mode used by the local routers/firewalls.

**R-RxGOOSE1 SRC IP**

*Range: 0.0.0.0 to 255.255.255 in steps of 1*

*Default: 127.0.0.1*

This setting applies to IEC 61850 Edition 2.

When the **RxGOOSE1 MODE** setting is other than R-GOOSE, the value of this setting is not used. When the **RxGOOSE1 MODE** setting is R-GOOSE and the **R-RxGOOSE RECEPTION MODE** setting is ASM, the value of this setting is not used. Otherwise the Source IP Address field of incoming R-GOOSE messages must exactly match this value for the message to be accepted as a valid RxGOOSE1 message. Set this setting to the value of the source IP address used by the publisher. For UR publishers, this value is in setting PRT# IP ADDRESS.

The UR does not validate the address entered. The default IP address 127.0.0.1 is a reserved, not a valid IP address. Enter a valid IP source address.

**R-RxGOOSE1 DST IP**

*Range: 0.0.0.0 to 255.255.255 in steps of 1*

*Default: 224.0.0.0*

This setting applies to IEC 61850 Edition 2.

When the **RxGOOSE1 MODE** setting is other than R-GOOSE, the value of this setting is not used. Otherwise the Destination IP Address field of incoming R GOOSE messages must exactly match this value for the message to be accepted as a valid RxGOOSE1 message. Set this setting to the same value as the R-GOOSE publisher's Destination IP Address. For UR publishers, this value is in setting R-TxGOOSE# DST IP.

The destination IP address needs to be a valid multicast or unicast IP address. The UR does not validate the address entered. The default IP address 224.0.0.0 is reserved, and hence not a valid multicast IP address.

**R-RxGOOSE1 SECURITY**

*Range: None, Signature, SignatureAndEncryption*

*Default: None*

This setting applies to IEC 61850 Edition 2.

This setting specifies the level of security (authentication/encryption) used for RxGOOSE1. None indicates no security mechanisms are in use. Signature indicates only signature (no encryption) is in use. SignatureAndEncryption indicates that both signature and encryption are in use. Normally this setting is set to match the GOOSE publisher's security method.

### RxGOOSE1 Member 1

*Range: End of List, BOOLEAN, FLOAT32, INT32, Dbpos (DPS), Quality, TimeStamp, Struct*

*Default: End of List*

This setting specifies the type that the first member of incoming GOOSE messages must be for the message to be accepted as a valid RxGOOSE1 message. There are similar settings for each of the up to 64 members that the UR is able to subscribe to in a given GOOSE message. The member before the first member setting set to "End of List" must be the last member of the message for the message to be accepted as a valid RxGOOSE1 message.

If the publisher is a UR 7.3x or 7.40 series device, set these settings to match the basic type of the members of the publisher's data set selected by the publisher's **TxGOOSE datSet** setting.

If the publisher dataset includes members with structured data, that is, data attributes, sub-data objects, and/or data attributes with sub-data attributes, configuration must use one of the new 7.40 UR Setup RxGOOSE Inputs pages. In this case the Member setting displays as the product-related name used by the publishing IED of the data object or data attribute, in standard SCSM format (e.g. Publisher1LD1/LLN0\$ST\$Off\$stVal).

Note that a dataset can hold at most 64 basic data attribute values, and that a single structured data object or attribute can contain multiple basic data attribute values. UR Setup software does not allow more than 64 basic data attribute values to be entered, in which case the last several members settings cannot be changed from End of List.

Note that the publisher's name alone does not contain all the information required for subscription, additional publisher information model information is stored elsewhere. For this reason, manual entry of the name is not supported.

### RxGOOSE inputs

The values received by RxGOOSE elements need to be converted to FlexLogic or FlexAnalog operands so that they can be used by other UR elements. This conversion is done by RxGOOSE Boolean, RxGOOSE DPS, and RxGOOSE Analog elements. Each RxGOOSE Boolean can convert the value of a specified Boolean value received by a specified RxGOOSE to a FlexLogic operand. Each RxGOOSE DPS can convert the value of a specified Dbpos (Double bit position) value to four FlexLogic operands, one for each of the four possible Dbpos states. Each RxGOOSE Analog can convert the value of a specified FLOAT32 member to a FlexAnalog operand. Each of these operands reverts to its default state when the RxGOOSE connectivity is lost. Other types of values can be present in subscribed GOOSE messages, but cannot be converted to operands.

When an RxGOOSE Input is mapped to a value in the GOOSE message, the associated q value is validated, if the q value is included in that GOOSE message as part of the data object.

The RxGOOSE Input value is reverted to its default value, if the associated:

- q.validity is invalid
- or q.test bit is set and the relay test mode is disabled

When the test mode function is Forcible or Isolated, the q.test bit is not validated. That means, when the relay is in Test or Test/blocked mode, the q.test = False is treated same as q.test = True.

RxGOOSE Boolean, RxGOOSE DPS, and RxGOOSE Analog elements are mapped to various data objects in <iedName>Master/GGIO3. This is to allow reading of their values via MMS and to allow references to them in SCL files. GGIO3 has no settings, nor is it visible in the UR Setup software. See the UR Family Communications Guide for more information on GGIO3.

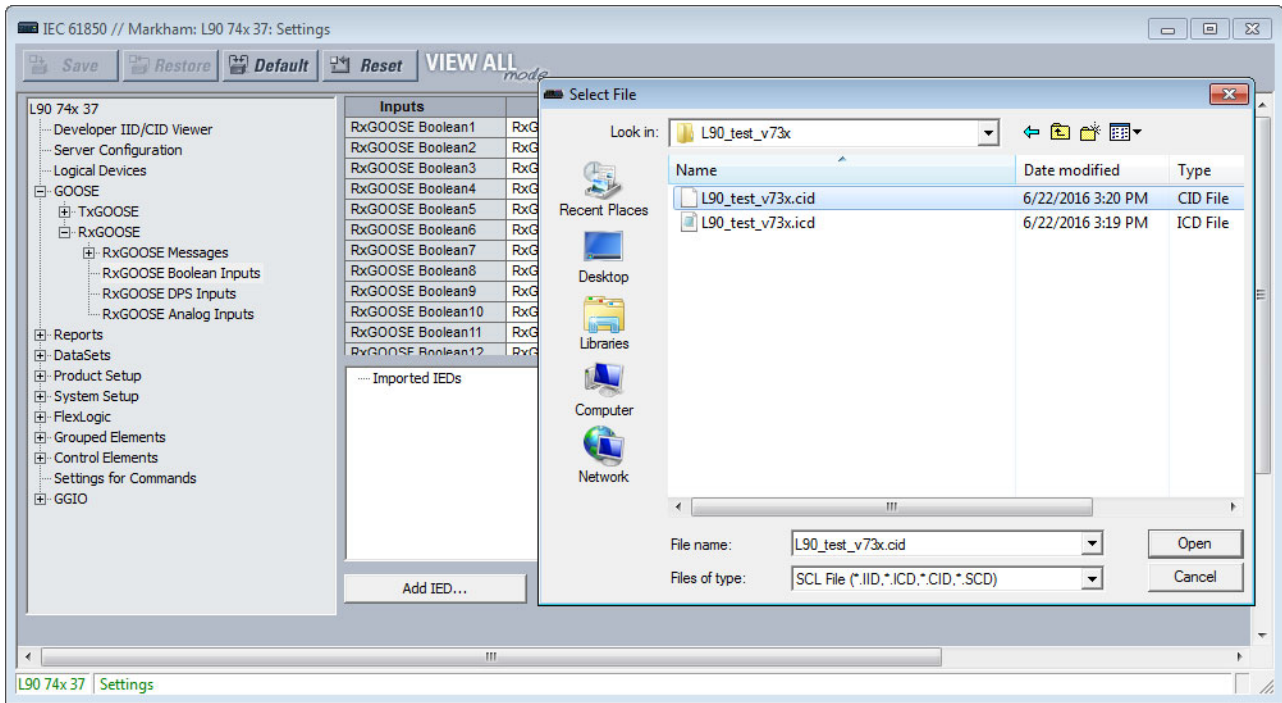
### RxGOOSE Boolean inputs

Navigate to **Settings > Product Setup > Communications > IEC 61850 > GOOSE > RxGOOSE > RxGOOSE Boolean Inputs**.

The number of RxGOOSE Boolean (remote inputs) is 256.

There are **Add IED** and **Remove IED** buttons. The **Add IED** button allows SCL files to be used, including ICD, CID, and SCD (supported in version 7.40 and later). With SCL file import, for Edition 1 the IP address in the ConnectedAP element must match one IP address of the device, while for Edition 2 one of the three IP addresses in the ConnectedAP element must match. When the file format is SCD, the system lists all IEDs inside the SCD file and lets the user select the ones to add. The figure shows a selection being made by importing a CID file using the **Add IED** function.

Figure 5-29: RxGOOSE Boolean panel (Edition 2)



Most of the settings are configured by drag-and-drop. However the ID, DEFAULT STATE, and EVENTS settings must be individually entered when the factory default values are not acceptable.

**RxGOOSE Boolean1 ID**

Range: 0 to 20 characters

Default: RxG Bool1

This setting allows the user to assign descriptive text to the name of the RxGOOSE Boolean1 FlexLogic operand. The full operand name is the value of this setting appended with " On". The basic and enhanced front panels display the first 17 characters of this setting plus " On" to fit the 20 character display.

**RxGOOSE Boolean1 RxGOOSE**

Range: None, RxGOOSE1, RxGOOSE2, and so on

Default: None

This setting selects the RxGOOSE containing the value that drives the RxGOOSE Boolean1 FlexLogic operand. If set to None, the RxGOOSE Boolean1 FlexLogic operand assumes its default state.

**RxGOOSE Boolean1 Member**

Range: 1 to 64 in steps of 1

Default: 1

This setting selects the GOOSE message member that drives the RxGOOSE Boolean1 FlexLogic operand. A setting of 1 selects the first member, 2 selects the second member, and so on. Entering a number greater than the number of members in the message and entering the number of a member which does not contain a BOOLEAN results in the RxGOOSE Boolean1 FlexLogic operand assuming its default state. The Subscribed to column identifies the particular Boolean subscribed to even if the member is a structure containing more than one Boolean.



**RxGOOSE Boolean1 DEFAULT STATE**

Range: On, Off, Latest/On, Latest/Off

Default: Off

This setting selects the logic state for the RxGOOSE Boolean1 FlexLogic operand if the UR has just completed startup and the selected RxGOOSE has not yet received a message, or the selected RxGOOSE has lost its connectivity with the publisher. The following choices are available:

- "On" value defaults the input to logic 1
- "Off" value defaults the input to logic 0
- "Latest/On" freezes the input in case of lost connectivity. If the latest state is unknown, such as after UR power-up but before the first communication, the input defaults to logic 1. When communication resumes, the input becomes fully operational.
- "Latest/Off" freezes the input in case of lost connectivity. If the latest state is unknown, such as after UR power-up but before the first communication, the input defaults to logic 0. When communication resumes, the input becomes fully operational.

**RxGOOSE Boolean1 EVENTS**

Range: Disabled, Enabled

Default: Disabled

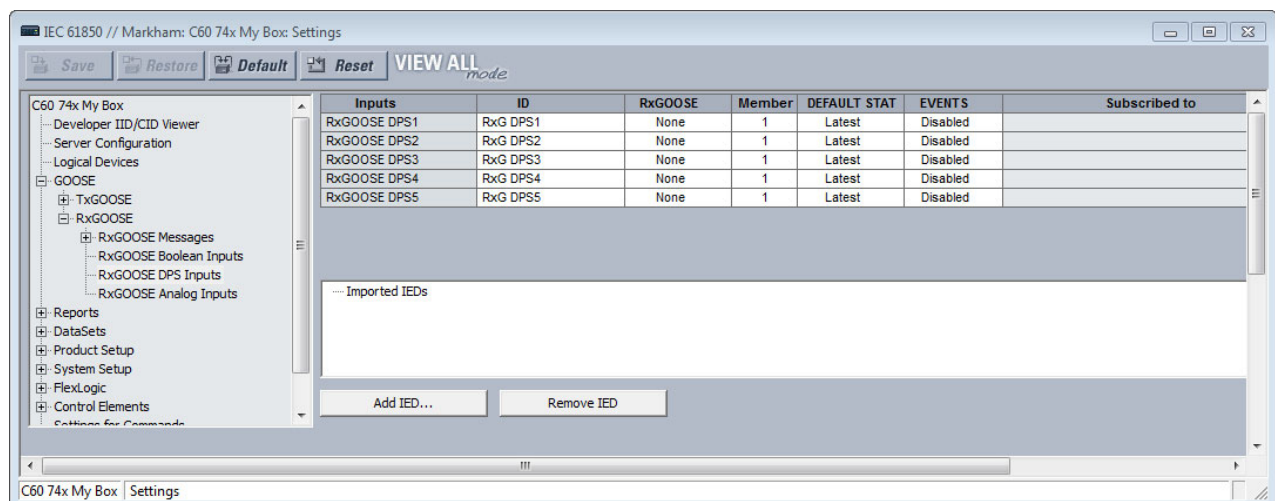
This setting selects whether Off to On transitions of the RxGOOSE Boolean1 FlexLogic operand are recorded by the event recorder. If set to Enabled, Off to On transitions are recorded. On to Off transitions are never recorded, even if events are enabled.

**RxGOOSE DPS inputs**

Navigate to **Settings > Product Setup > Communications > IEC 618560 > GOOSE > RxGOOSE > RxGOOSE DPS Inputs**.

There are **Add IED** and **Remove IED** buttons. The **Add IED** button allows SCL files to be used, including ICD, CID, and SCD (supported in version 7.40 and later). With SCL file import, for Edition 1 the IP address in the ConnectedAP element must match one IP address of the device, while for Edition 2 one of the three IP addresses in the ConnectedAP element must match. When the file format is SCD, the system lists all IEDs inside the SCD file and lets the user select the ones to add.

Figure 5-30: RxGOOSE DPS Inputs panel (Edition 2)



**RxGOOSE DPS1 ID**

*Range: 0 to 20 characters*

*Default: RxG DPS1*

This setting allows the user to assign descriptive text to the names of the four RxGOOSE DPS1 FlexLogic operands. The full operand name is the value of this setting appended with "Interm," "On," "Off," or "Bad." The basic and enhanced front panels display the first 13 characters of this setting plus the state suffix to fit the 20 character display.

**RxGOOSE DPS1 RxGOOSE**

*Range: None, RxGOOSE1, RxGOOSE2, and so on*

*Default: None*

This setting selects the GOOSE message containing the value that drives the RxGOOSE DPS1 FlexLogic operand. If set to None, the RxGOOSE DPS1 FlexLogic operand assumes its default state.

**RxGOOSE DPS1 Member**

*Range: 1 to 64 in steps of 1*

*Default: 1*

This setting selects the GOOSE message member that drives the RxGOOSE DPS1 FlexLogic operand. A setting of 1 selects the first member, 2 selects the second member, and so on. Entering a number greater than the number of members in the message and entering the number of a member that is not a Dbpos results in the RxGOOSE DPS1 FlexLogic operand assuming its default state. In the case that the member is a structure containing more than one Dbpos, the Subscribed to column identifies the particular Dbpos subscribed to.

**RxGOOSE DSP1 DEFAULT STATE**

*Range: Intermediate-state, Off, On, Bad-state, Latest*

*Default: Latest*

This setting selects the logic state for the data attribute @Master/GGIO3.IndPos01.stVal and the DPS FlexLogic operands when the UR has just completed start-up and the selected RxGOOSE has not yet received a message, and when the RxGOOSE has lost its connection with the publisher. When this setting is selected to Latest, the value of @Master/GGIO3.IndPosψψ.stVal is Intermediate-state when the UR has just completed start-up and the selected RxGOOSE has not yet received a message, and the latest received value when the RxGOOSE loses its connectivity with the publisher.

**RxGOOSE DPS1 EVENTS**

*Range: Disabled, Enabled*

*Default: Disabled*

This setting selects whether Off to On transitions of the RxGOOSE DPS1 FlexLogic operands are recorded by the event recorder. If set to Enabled, Off to On transitions are recorded. On to Off transitions are never recorded, even if events are enabled.

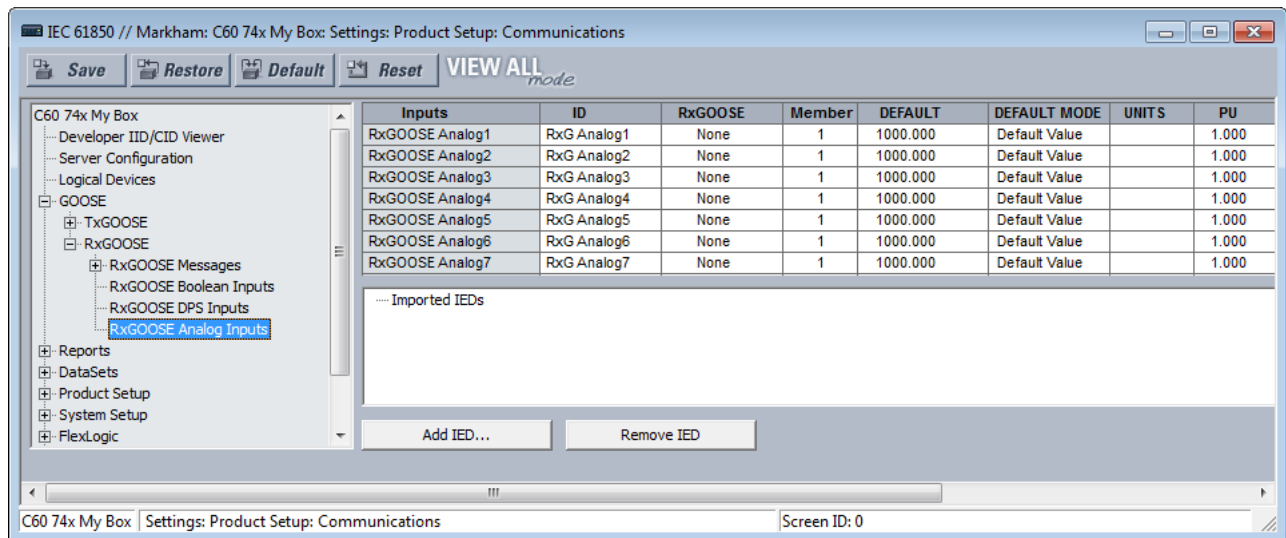
**RxGOOSE analog inputs**

Navigate to **Settings > Product Setup > Communications > IEC 61850 > GOOSE > RxGOOSE > RxGOOSE Analog Inputs**.

There are **Add IED** and **Remove IED** buttons. The **Add IED** button allows SCL files to be used, including ICD, CID, and SCD (supported in version 7.40 and later). With SCL file import, for Edition 1 the IP address in the ConnectedAP element must match one IP address of the device, while for Edition 2 one of the three IP addresses in the ConnectedAP element must match. When the file format is SCD, the system lists all IEDs inside the SCD file and lets the user select the ones to add.



Figure 5-31: RxGOOSE Analog Inputs panel (Edition 2)



There are 32 RxGOOSE analog inputs.

#### RxGOOSE Analog1 ID

*Range: 0 to 20 characters*

*Default: RxG Analog1*

This setting allows the user to assign descriptive text to RxGOOSE Analog1. Unlike RxGOOSE Booleans and RxGOOSE DPS, the RxGOOSE Analog operands have fixed names, for example RxGOOSE Analog1.

#### RxGOOSE Analog1 RxGOOSE

*Range: None, RxGOOSE1, RxGOOSE2, and so on*

*Default: None*

This setting selects the GOOSE message that drives the RxGOOSE Analog1 FlexAnalog operand. If set to None, the RxGOOSE Analog1 FlexAnalog operand assumes its default state.

#### RxGOOSE Analog1 Member

*Range: 1 to 64 in steps of 1*

*Default: 1*

This setting selects the GOOSE message member that drives the RxGOOSE Analog1 FlexAnalog operand. A setting of 1 selects the first member, 2 selects the second member, and so on. Entering a number greater than the number of members in the message and entering the number of a member that does not contain a FLOAT32 results in the RxGOOSE Analog1 FlexAnalog operand assuming its default state. The Subscribed to column identifies the particular FLOAT32 subscribed to even if the member is a structure containing more than one FLOAT32.

#### RxGOOSE Analog1 DEFAULT

*Range: -1000000.000 to 1000000.000 in steps of 0.001*

*Default: 1000.000*

This setting specifies the value of the GOOSE analog input when the selected RxGOOSE has lost its connectivity with the publisher and the RxGOOSE Analog1 DEFAULT MODE is set to "Default Value." Otherwise this setting has no effect. This setting is stored as an IEEE 754 / IEC 60559 floating point number. Because of the large range of this setting, not all possible values can be stored. Some values can be rounded to the closest possible floating point number.

**RxGOOSE Analog1 DEFAULT MODE***Range: Default Value, Last Known**Default: Default Value*

When the selected RxGOOSE has lost its connectivity with the publisher and this setting is "Last Known," the value of the RxGOOSE Analog1 FlexLogic operand remains at the last received value. When the selected RxGOOSE has lost its connectivity with the publisher and this setting value is "Default Value," then the RxGOOSE Analog1 FlexLogic operand is defined by the RxGOOSE Analog1 DEFAULT setting. After restart, until a message is received, the operand value is the default value.

**RxGOOSE Analog1 UNITS***Range: up to 4 characters**Default: empty string*

This setting specifies a four-character string that is used in the actual values display of RxGOOSE Analog1.

RxGOOSE Analogs are floating-point values, with no units. The RxGOOSE UNIT and PU base settings allow the user to configure RxGOOSE Analog, so that it can be used in a FlexElement.

RxGOOSE Analogs that represent current, voltage, power, frequency, angles, or power factor can be used in a FlexElement. The following text must be used in the UNITS setting, to represent these types of analogs: A, V, W, var, VA, Hz, deg, and no text (blank setting) for power factor.

RxGOOSE Analogs can be compared to other RxGOOSE Analogs with any character string or no string.

**RxGOOSE Analog1 PU Base in kilo***Range: 0.000 to 1000000000.000 in steps of 0.001**Default: 1.000*

This setting specifies the per-unit base value for other G30 features to use with the RxGOOSE Analog1 operand. A FlexElement for instance subtracts two quantities after converting their values to integers rescaled to a common base, the common base being the largest of the base values of the two quantities. If one of quantities is RxGOOSE Analog1 and its per-unit base value is not appropriate, the rescaling operation can result in unnecessary loss of precision or overflow in the integer result. The FlexElement Base Units table in the Settings > FlexLogic > FlexElements section later, which tabulates the per-unit base value used by its pickup setting and implies the per-unit base used by other FlexAnalog, can be of use in selecting a value for the **RxGOOSE Analog1 PU** setting.

Some UR elements have requirements for the type of input operands, for instance current type or voltage type. These elements assume that RxGOOSE Analog operands are of whatever type is necessary to meet these requirements.

The per-unit base setting represents thousands, not single units. For example, a PU base of 1.000 is actually 1000 and a PU base of 0.001 is 1.

When using RxGOOSE Analogs and PU base in FlexElements, the largest value that can be displayed in the FlexElement actual values is 2,140,000.000.

**Reports**

Navigate to **Settings > Product Setup > Communications > IEC 61850 > Reports**.

**Report settings**

Navigate to **Settings > Product Setup > Communications > IEC 61850 > Reports > Report Settings**.

**ReportSettings rptID***Range: Dyn, Conf**Default: Dyn*

When set to Dyn, the RptID attribute in any buffered and unbuffered report control block can be modified by an MMS client while the control block's RptEna attribute is false. The RptID is the name of the report.

**ReportSettings optFields***Range: Dyn, Conf**Default: Dyn*

When set to Dyn, the OptFlds attribute in any buffered and unbuffered report control block can be modified by an MMS client while the control block's RptEna attribute is false.

**ReportSettings bufTime**

Range: Dyn, Conf  
 Default: Dyn

When set to Dyn, the BufTm attribute in any buffered and unbuffered report control block can be modified by an MMS client while the control block's RptEna attribute is false.

**ReportSettings trgOps**

Range: Dyn, Conf  
 Default: Dyn

When set to Dyn, the TrgOps attribute in any buffered and unbuffered report control block can be modified by an MMS client while the control block's RptEna attribute is false.

**ReportSettings intgPd**

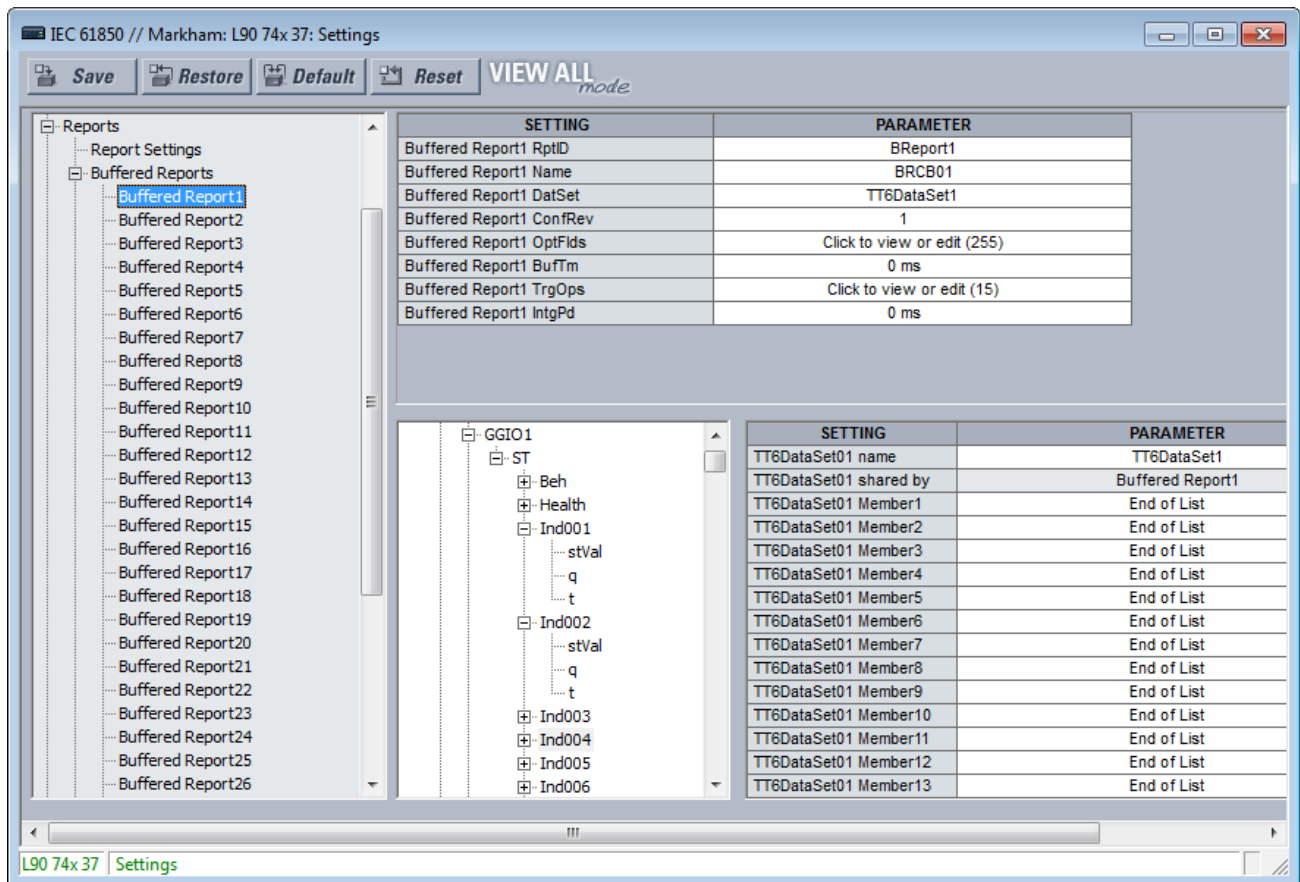
Range: Dyn, Conf  
 Default: Dyn

When set to Dyn, the IntgPd attribute in any buffered and unbuffered report control block can be modified by an MMS client while the control block's RptEna attribute is false.

**Buffered and unbuffered reports**

Navigate to **Settings > Product Setup > Communications > IEC 61850 > Reports > Buffered Reports** or **Unbuffered Reports**.

Figure 5-32: IEC 61850 buffered report panel



An IEC 61850 Report server is an efficient method to deliver generic substation event information from a single server to a single client, such as a supervisory control IED. A Configurable Report is a UR element implementing an IEC 61850 Report server, either of the buffered or unbuffered kind. The following table lists the number of Configurable Report elements. Each Configurable Report element can report the values of up to 64 FlexLogic or FlexAnalog operands. Buffered report elements queue value changes that occur while the client is offline and delivered when the client re-connects. Up to 512 events can be queued. Unbuffered control blocks purge all value change events when the connection to the client is lost; any events that occur while the client is not connected are lost.

**Table 5-11: Number of report elements**

	Number
Buffered reports	30
Unbuffered reports	18

When using IEC 61850 Edition 2, configurable Reports interoperate with any client device of any manufacturer that conforms to the IEC 61850 edition 1.0 or 2.0 report client requirements.

When using IEC 61850 Edition 1, configurable Reports interoperate with any client device of any manufacturer that conforms to the IEC 61850 edition 1.0 report client requirements.

The entities whose values are reported by a Configurable Report are known as members. The members are itemized in an ordered list known as a data set. Each Configurable Report can use any one of the data sets provided that no more than four data sets are used for reports. This restriction is to limit the amount of processing power that can be allocated to reporting.

Each enabled Configurable Report transmits an update to its client whenever a value change is detected in one or more of its members. Also, the control block can be configured to send integrity reports containing the present value of all members either on demand from the client or periodically. A TCP handshaking mechanism causes messages that are not read and acknowledged by the client to be retransmitted.

For a Configurable Report to operate, its members must be selected (that is, its data set configured) and a client must open a connection to, configure, and enable its report control block. Control blocks and data sets can be pre-configured by sending the G30 a CID file. See the UR Family Communications Guide for details. EnerVista UR Setup also can be used to select the data set members and to pre-configure the control blocks.

Each buffered report has the following settings.

**Buffered Report1 RptID**

*Range for Edition 2: 0 to 129 VisibleString characters*

*Range for Edition 1: 0 to 65 VisibleString characters*

*Default: empty string*

The name of the report. The entered value sets the RptID value in Buffered Report1 messages, and it can be used by the client to discriminate Buffered Report1 messages from other messages. If the number of characters entered is zero, the value used for RptID in messages is an ObjectReference to the report's control block, that is, "<LDName>/LLN0\$BR\$"BRCB01".

**Buffered Report1 Name**

*Range: 0 to 32 VisibleString characters*

*Default: BRCB01*

The entered value sets the report control block name value for Buffered Report1.

**Buffered Report1 DataSet**

*Range: None, TT6DataSet1, TT6 DataSet2, ..., TT3DataSet01, TT3DataSet02, ...*

*Default: None*

This setting selects the data set whose members' status is reported in Buffered Report1 messages using the UR Setup software designator for the data set. The IEC 61850 name of the data sets are configured in the Datasets panel, as described later.

An ObjectReference to the data set, which consists of the concatenation of the string "<LDName>/LLN0\$" and the data set name, is used in the datSet field of report messages, and it can be used by the client to discriminate Buffered Report1 messages from other messages.



The performance of the report is determined by the performance of the selected dataset. When the selection is TT3DataSet01, TT3DataSet02, ... it is possible that transient events can be missed.

To configure a DataSet, select it at the top of the window from the drop-down list, for example DataSet02 shown in the previous figure. In the lower part of the window, drag and drop configuration items to the right side. For example select the **ST Ind001 stVal** item and drag it to DataSet Member 1. Dataset members configured here affect other Report or TxGOOSE control blocks that use the same DataSet.

### Buffered Report1 ConfRev

Range: 0 to 4294967295 in steps of 1

Default: 1

The entered value sets the confRev value in Buffered Report1 messages, and it can be used by clients to discriminate report messages of the expected configuration revision from messages of a different revision. The standard requires that confRev be incremented each time the members or the order of the members is changed, and each time the data set name is changed. The standard states that the value of 0 is reserved.

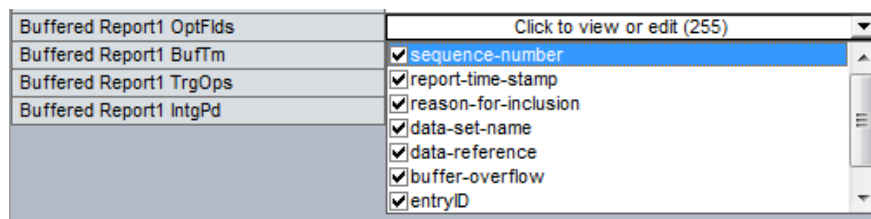
### Buffered Report1 OptFlds

Range: The check box for each individual bit can be enabled or not (see figure)

Default: All bits enabled/ true

The OptFlds setting is bitstring that controls which of the optional fields are included in report messages. The figure shows the available option bits. To reduce message size, uncheck any fields that are not needed.

Figure 5-33: Options for buffered report messages (Edition 2)



### Buffered Report1 BufTm

Range: 0 to 4294967295 in steps of 1

Default: 0 ms

The entered value sets the time interval in milliseconds for the buffering of events for inclusion in a single report.

### Buffered Report1 TrgOps

Range: The check box for an individual bit can be enabled or not

Default: All bits enabled / true

The TrgOps setting is bitstring that controls which trigger conditions are monitored in this report. The options are as follows. Uncheck any trigger conditions that are not needed.

- data-change
- quality-change
- integrity
- general interrogation (IEC 61850 Edition 2)

### Buffered Report1 IntgPd

Range: 0 to 4294967295 in steps of 1

Default: 0 ms

The entered value sets the period in milliseconds for generating Buffered Report1 integrity reports. An integrity report includes the values of all members of the referenced data set, whether a change has occurred or not.

Each unbuffered report has the following settings.

**Unbuffered Report1 RptID**

*Range for Edition 2: 0 to 129 VisibleString characters*

*Range for Edition 1: 0 to 65 VisibleString characters*

*Default: empty string*

The name of the report. The entered value sets the RptID value in Unbuffered Report1 messages, and it can be used by the client to discriminate Unbuffered Report1 messages from other messages. If the number of characters entered is zero, the value used for RptID in messages is an ObjectReference to the report's control block, that is, "<LDName>/LLN0\$RP\$"URCB01".

**Unbuffered Report1 Name**

*Range: 0 up to 32 VisibleString characters*

*Default: URCB01*

The entered value sets the report control block name value for Unbuffered Report1.

**Unbuffered Report1 DataSet**

*Range: None, TT6DataSet1, TT6 DataSet2, ..., TT3DataSet01, TT3DataSet02, ...*

*Default: None*

This setting selects the data set whose members' status is reported in Unbuffered Report1 messages using the UR Setup software designator for the data set. The IEC 61850 name of the data sets are configured in the Datasets panel, as described later.

An ObjectReference to the data set, which consists of the concatenation of the string "<LDName>/LLN0\$" and the data set name, is used in the dataSet field of report messages, and it can be used by the client to discriminate Unbuffered Report1 messages from other messages.

The performance of the report is determined by the performance of the selected dataset. When the selection is TT3DataSet01, TT3DataSet02, ... it is possible that transient events can be missed.

**Unbuffered Report1 ConfRev**

*Range: 0 to 4294967295 in steps of 1*

*Default: 1*

The entered value sets the confRev value in Unbuffered Report1 messages, and it can be used by clients to discriminate report messages of the expected configuration revision from messages of a different revision. The standard requires that confRev be incremented each time the members or the order of the members is changed, and each time the data set name is changed. The standard states that the value of 0 is reserved.

**Unbuffered Report1 OptFlds**

*Range: The check box for an individual bit can be enabled or not*

*Default: All bits enabled / true*

The OptFlds setting is bitstring that controls which of the optional fields are included in report messages. The options are as follows. To reduce message size, uncheck any fields that are not needed.

- sequence-number
- report-time-stamp
- reason-for-inclusion
- data-set-name
- data-reference
- conf-revision

For IEC 61850 Edition 2, the OptFlds bits buffer-overflow and entryID also listed are not applicable to unbuffered reports even though the bits exist in the protocol. They are unchecked by default.

For IEC 61850 Edition 1, the entryID also listed is not applicable to unbuffered reports even though the bits exist in the protocol. It is unchecked by default.

**Unbuffered Report1 BufTm**

*Range: 0 to 4294967295 in steps of 1*

*Default: 0 ms*

The entered value sets the time interval in milliseconds for the buffering of events for inclusion into a single report.

### Unbuffered Report1 TrgOps

Range: The check box for an individual bit can be enabled or not

Default: All bits enabled / true

The TrgOps setting is bitstring that controls which trigger conditions are monitored in this report. The options are as follows. Uncheck any trigger conditions that are not needed.

- data-change
- quality-change
- integrity
- general interrogation (IEC 61850 Edition 2)

### Unbuffered Report1 IntgPd

Range: 0 to 4294967295 in steps of 1

Default: 0 ms

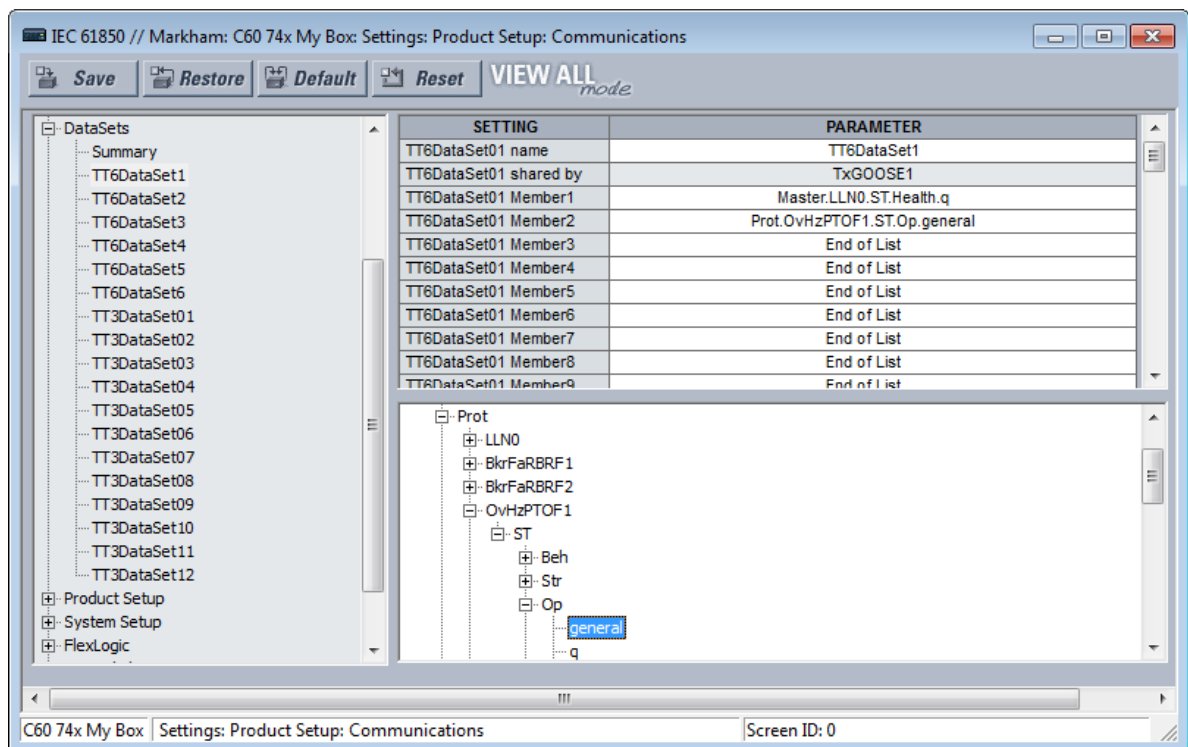
The entered value sets the period in milliseconds for generating Unbuffered Report1 integrity reports. An integrity report includes the values of all members of the referenced data set, whether a change has occurred or not.

## DataSets

Navigate to **Settings > Product Setup > Communications > IEC 61850 > DataSets**.

As mentioned in the preceding GOOSE and Reports sections, the members whose values are communicated by these services are itemized in an ordered list known as a data set. Each UR with the IEC 61850 option has 18 data sets (six fast and 12 slow). Each data set can contain as many as 64 members. Any data set can be used simultaneously by any number of TxGOOSE elements and/or by any number of Configurable Report elements. UR Setup software can configure any FlexLogic operands and any FlexAnalog operands as members.

Figure 5-34: IEC 61850 DataSets (Edition 2)





UR Setup software requires data set members to be IEC 61850 data objects or data attributes with Functional Constraint ST or MX. Certain FlexLogic and FlexAnalog operands have factory-assigned data attributes as tabulated in the UR Family Communications Guide. All FlexLogic and FlexAnalog operands can be user-assigned to GGIO1 or GGIO4 data attributes, so that operands without factory-assigned data attributes can still have their values published. See the GGIO1 and GGIO4 sections later for details.

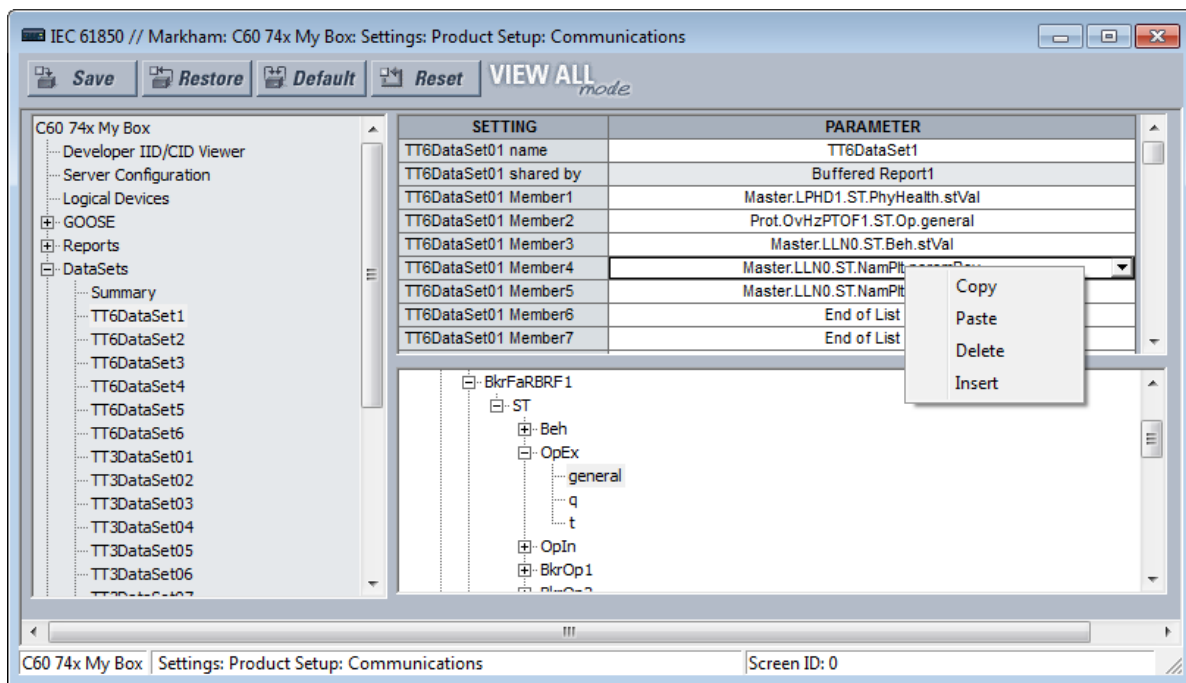
Datasets used by TxGOOSE1, TxGOOSE2, and/or by reports also provide a chatter suppression service for their Boolean members. Oscillation in a value, also known as chatter, can be caused by errors in logic programming, inadequate hysteresis (deadband) on a threshold, or a failed station component. Chatter can flood a communications network with GOOSE messages, degrading response time for all users. If chatter is detected in a Boolean member, TxGOOSE suspends GOOSE event message triggering and report message triggering from that member for as long as the condition exists, and for a minimum period of one second. While sending is suspended, a self-test message identifying the specific data item detected as oscillating is activated.

For a summary of the panels in which the data sets are used, the path is **Settings > Product Setup > Communications > IEC 61850 > DataSets > Summary**.

For the settings, navigate to **Settings > Product Setup > Communications > IEC 61850 > DataSets > TT6DataSet1** for the first data set.

Copy and paste functions are available when right-clicking a DataSet. They allow the target dataset to be configured based on its order code. If some dataset items are not supported, they are not pasted, and a warning message shows a list of dataset items that were not supported and not pasted. The **DataSet name** is not copied or pasted. In short, use this feature to copy a **DataSet Member** setting and paste it into another Member setting, a text file, or Word, as examples.

Figure 5-35: Member right-click



**DataSet01 name**

Range: 0 to 32 VisibleString characters

Default: DataSet01

The value entered sets the name of the data set, which is required to be unique within the UR for proper operation. The value entered sets the name of the data set, which is required to be unique within the UR for proper operation. Fast datasets start with TT6, and slow datasets start with TT3. Up to six fast datasets are allowed. Up to four fast GOOSE datasets are allowed.



An ObjectReference to the data set consists of a string that is the concatenation of "<LDName>/LLN0\$" and the DataSet01 name setting value. An ObjectReference to the data set is published in the datSet field of TxGOOSE messages, and it can be used by subscribers to discriminate the messages of that TxGOOSE from other GOOSE messages. An ObjectReference to the data set is optionally published in the DatSet field of Report messages. Valid characters are upper and lowercase letters, digits, and the underscore ( \_ ) character. The first character must be a letter.

#### DataSet01 shared by

Range: 0 to 32 VisibleString characters

Default:

Names of all control blocks that use this DataSet. Read-only field.

#### DataSet01 Member1

Range: End of List or any instantiated 61850 data object or data attribute with Functional Constraint ST or MX

Default: End of List

This setting specifies the first member in TxGOOSE1 messages. There is a similar setting for each of the up to 64 members that the UR allows in a Dataset. Only values of members before the first set to End of List are published.

Select the member from the drop-down list. Or right-click an entry to copy, paste, delete, or insert.

### Product setup

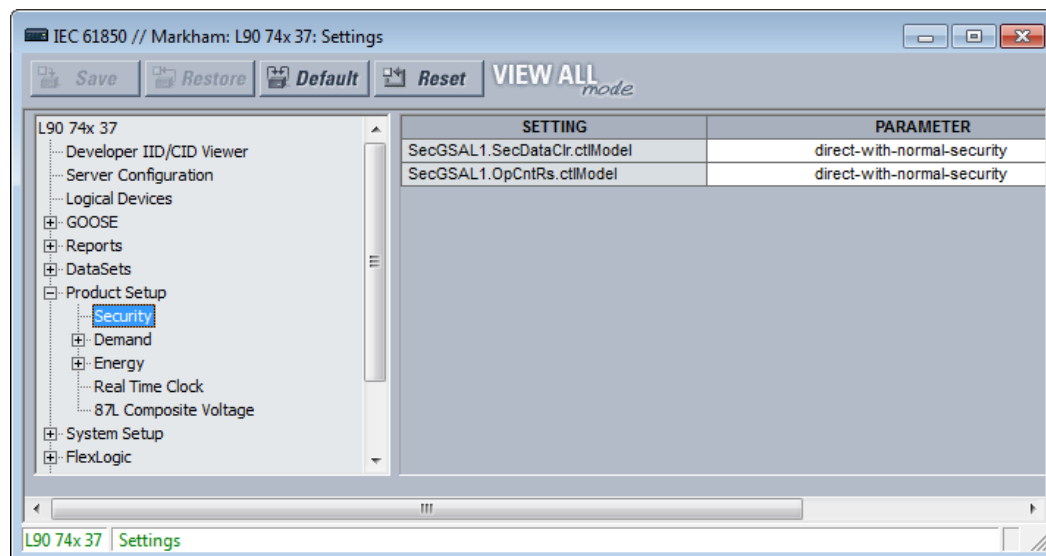
Navigate to **Settings > Product Setup > Communications > IEC 61850 > Product Setup**.

### Security

This setting applies to IEC 61850 Edition 2.

Navigate to **Settings > Product Setup > Communications > IEC 61850 > Product Setup > Security**.

Figure 5-36: IEC 61850 Security



#### SecGSAL1.SecDataClr.ctlModel

Range: direct-with-normal-security, sbo-with-normal-security

Default: direct-with-normal-security

This setting selects the control model that clients must use to clear security data via commands to SecGSAL1.SecDataClr. "sbo" here is select-before-operate.

**SecGSAL1.OpCntRs ctlModel**

Range: direct-with-normal-security, sbo-with-normal-security  
 Default: direct-with-normal-security

This setting selects the control model that clients must use to clear security data via commands to SecGSAL1.OpCntRs. "sbo" here is select-before-operate.

**Demand**

Deadband parameters of measured values related to the Demand metering are configured here.

**Energy**

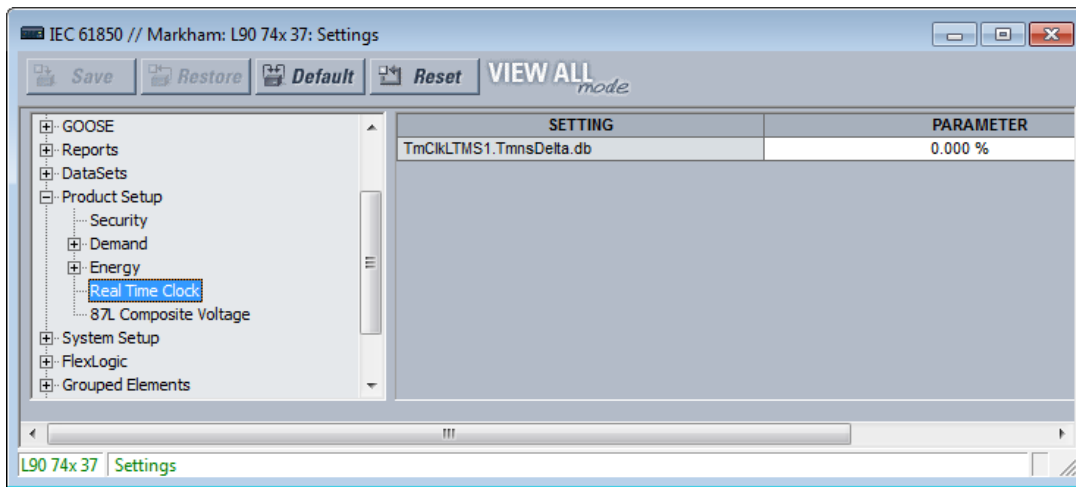
Deadband parameters of measured values related to the Energy metering are configured here.

**Real Time Clock**

This setting applies to IEC 61850 Edition 2.

Navigate to **Settings > Product Setup > Communications > IEC 61850 > Product Setup > Real Time Clock**.

Figure 5-37: IEC 61850 Real Time Clock



**TmClkLTMS1.TmnsDelta.db**

Range: 0.000 to 100.000 %  
 Default: 0.000 %

This setting is a deadband setting and is used by the relay to determine when to update the "mag" and "cVal" values from the associated "instMag" and "instCVal" values. The value shall represent the percentage of difference between maximum and minimum in units of 0.001%. The minimum and maximum values for TmnsDelta data object are -500000000 ns and 500000000 ns respectively and for example, a setting value of 0.002% results in the dead banded value of  $(500000000 - (-500000000)) * 0.002 / 100 = 20000$  ns. The default setting value of 0.000% does not update the "mag" and "cVal" values.

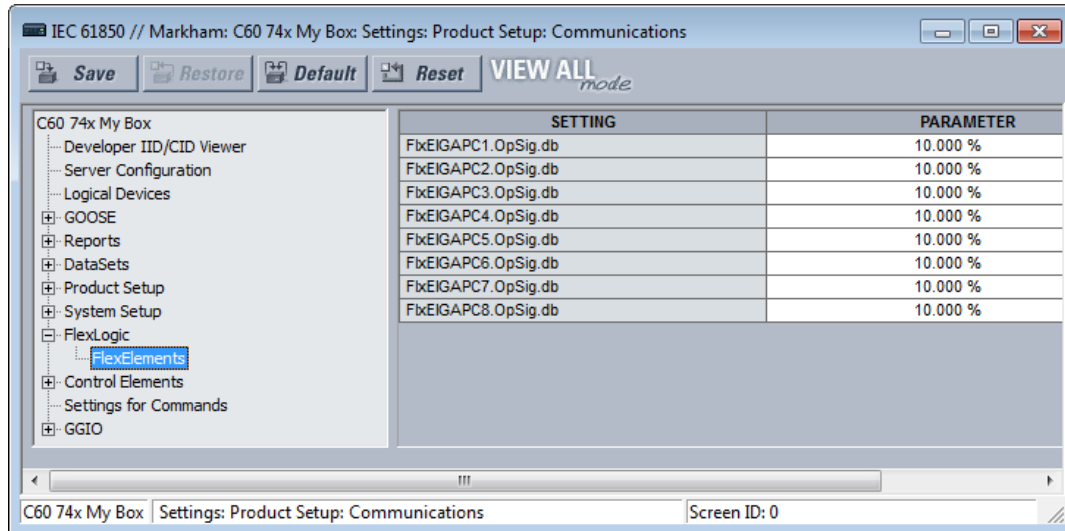
**Deadband settings**

A deadband is a range in which no action occurs, usually expressed as a percentage.

The IEC 61850 panels contain hundreds of deadband settings, such as in the following panels: Product Setup > Real Time Clock, FlexLogic, Control Elements, and GGIO4. Each panel is not outlined here. The FlexLogic category applies to IEC 61850 Edition 2.

Deadband setting names all end either with "DB" or .db. As they all work the same way, but each on a different analog value, a single description applicable to all deadband settings is given here. The analog value that each deadband setting applies is usually obvious from the name of the setting. However, a tabulation of the analog values and their associated deadband setting can be found in the UR Family Communications Guide.

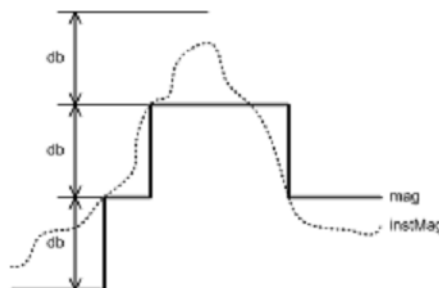
Figure 5-38: Deadband settings with .db suffix (Edition 2)



GOOSE, buffered report, and unbuffered report messages are for the most part transmitted only when there is a value change in one or more of their members. Most analog values continuously dither by an amount that is not significant. Were a report to be sent each time an insignificant analog value change occurred, then the communications network floods with GOOSE and report messages, degrading response time for all users.

To control this, a deadband setting is provided for each analog value. Also, in addition to the present actual value of each analog ("instMag" in the following figure), there is a deadbanded value ("mag" in the figure), which is updated with the present value only when the difference between the two exceeds the deadband setting (db in the figure). Changes to this deadbanded value trigger transmissions when included in GOOSE and report data sets.

Figure 5-39: Deadband settings



Deadband settings are entered in UR Setup software in units of percent of the difference between the "max." and "min." of the associated analog value. A zero deadband setting suppresses transmission triggering. The range of deadband settings is 0.000 to 100.000% in steps of 0.001. The default value is 0.000%.

GGIO4 elements have individual settings for "min." and "max." The min. and max. for FlxEIGAPC#.OpSig.db (FLEXELEMENT # OpSig) are -50 pu and +50 pu respectively. The min. value for all other quantities is 0. The max. values are as follows:

- Phase current — 46 x phase CT primary setting
- Neutral current — 46 x ground CT primary setting
- Ground current (sensitive ground CT) — 4.6 x sensitive ground CT primary setting
- Phase, phase-to-phase, and sequence voltage — 275 x phase VT ratio setting

- Auxiliary voltage — 275 x auxiliary VT ration setting
- Power (real, reactive, apparent, 3-phase, and 1-phase) — 4 x phase CT primary setting x 1.5 x VT Secondary setting x VT ratio setting
- Energy (real or imaginary) — 4 x phase CT primary setting x 1.5 x VT Secondary setting x VT ratio setting x 1 hour
- Frequency — 90 Hz
- Frequency rate of change — 90 Hz/s
- Power factor — 2
- Angle — 360 degrees

Select the deadband settings from knowledge of the characteristics of the power system quantity measured and knowledge of the demands of the applications receiving the measurement via GOOSE or report such that changes of significance to the application are promptly reported, yet the network is not overly burdened with event messages.

### Signal sources

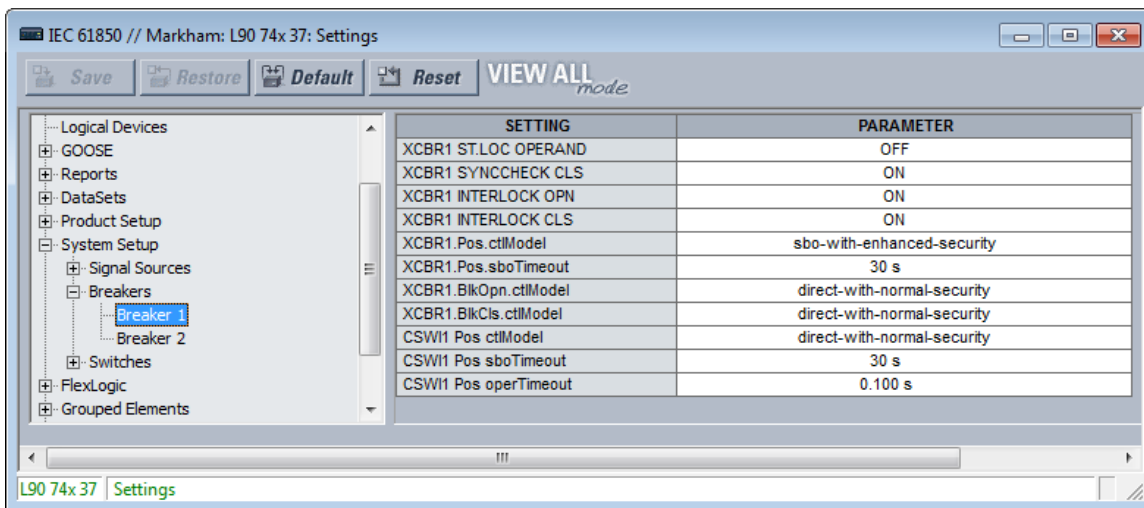
Deadband parameters of measured values related to the signal sources are configured here.

### Breakers

The UR breaker control and status monitoring elements have certain settings that configure how the IEC 61850 protocol interacts with these elements. These settings are described in this section. See the Breakers section in the System Setup section of this chapter for details on the operation of breaker control elements.

Navigate to **Settings > Communications > IEC 61850 > System Setup > Breakers > Breaker 1** to access the settings that configure the IEC 61850 protocol interface with the first breaker control and status monitoring element. The settings and functionality for the others are similar.

Figure 5-40: IEC 61850 Breaker panel (Edition 2)



#### XCBR1 ST.LOC OPERAND

Range: any FlexLogic operand

Default: OFF

This setting is used to select a FlexLogic operand that declares to IEC 61850 services that breaker 1 is selected for local control. While the selected operand is asserted, BkrOXCBR1.Loc.stVal is true and IEC 61850 commands to BkrCSW11.Pos and BkrOXCBR1.Pos are not accepted, and a Negative Response (-Rsp) is issued with the REASON CODE of Blocked-by-switching-hierarchy.

**XCBR1 SYNCHECK CLS***Range: any FlexLogic operand**Default: ON*

This setting is used to select a FlexLogic operand that declares to IEC 61850 services that synchrocheck conditions are acceptable for closing breaker 1. If a SelectWithValue or Operate service with `ctlVal` true and with `Check.SynchroCheck` true is requested of either `BkrCSWI1.Pos` or `Bkr0XCBR1.Pos` and the selected operand is not asserted, a Negative Response (-Rsp) is issued with the REASON CODE of Blocked-by-synchrocheck.

**XCBR1 INTERLOCK OPN***Range: any FlexLogic operand**Default: ON*

This setting is used to select a FlexLogic operand that declares to IEC 61850 services that interlocking conditions are not acceptable for opening breaker 1. While the selected operand is asserted, the value of `BkrCILO.EnaOpn.stVal` is false. If a SelectWithValue or Operate service with `ctlVal` false and with `Check.Interlock-check` true is requested of either `BkrCSWI1.Pos` or `Bkr0XCBR1.Pos`, and the selected operand is not activated, a Negative Response (-Rsp) is issued with the REASON CODE of Blocked-by-interlocking.

**XCBR1 INTERLOCK CLS***Range: any FlexLogic operand**Default: ON*

This setting is used to select a FlexLogic operand that declares to IEC 61850 services that interlocking conditions are not acceptable for closing breaker 1. While the selected operand is asserted, the value of `BkrCILO.EnaCls.stVal` is false. If a SelectWithValue or Operate service with `ctlVal` true and with `Check.Interlock-check` true is requested of either `BkrCSWI1.Pos` or `Bkr0XCBR1.Pos` and the selected operand is not activated, a Negative Response (-Rsp) is issued with the REASON CODE of Blocked-by-interlocking.

**XCBR1 Pos ctlModel***Range: status-only, direct-with-normal-security, sbo-with-normal-security, direct-with-enhanced-security, sbo-with-enhanced-security**Default: sbo-with-enhanced-security*

This setting selects the control model clients must use to successfully control the breaker 1 signals marked `Bkr0XCBR1.PosOpn.ctlVal` and `Bkr0XCBR1.PosCls.ctlVal` on the Breaker Control Logic (Sheet 1 of 2) diagram in the Settings > System Setup section later in this chapter. These signals force a breaker 1 three-phase trip or close control while the operand selected by setting XCBR1 ST.LOC OPERAND is not active.

"sbo" here is select-before-operate. Enhanced security means that the UR reports to the client the breaker 1 position at the end of the command sequence.

**XCBR1 Pos sboTimeout***Range: 2 to 60 s in steps of 1 s**Default: 30 s*

This setting specifies the maximum time between a select and an operate command to breaker 1 signals marked `Bkr0XCBR1.PosOpn.ctlVal` and `Bkr0XCBR1.PosCls.ctlVal` in order for the operand to be successful. This setting is only relevant when XCBR1 Pos `ctlModel` is `sbo-with-normal-security` or `sbo-with-enhanced-security`.

**XCBR1 BlkOpn ctlModel***Range: status-only, direct-with-normal-security, sbo-with-normal-security**Default: direct-with-normal-security*

This setting selects the control model clients must use to successfully control the breaker 1 signal marked `Bkr0XCBR1.BlkOpn.ctlVal` signal on the Breaker Control Logic (Sheet 1 of 2) diagram in the Settings > System Setup section later. This signal when true blocks breaker 1 trip control while the operand selected by setting XCBR1 ST.LOC OPERAND is not active.

**XCBR1 BlkCls ctlModel**

*Range: status-only, direct-with-normal-security, sbo-with-normal-security*

*Default: direct-with-normal-security*

This setting selects the control model clients must use to successfully control the breaker 1 signal marked BkrOXCBR1.BlkCls.ctIVal signal on the Breaker Control Logic (Sheet 1 of 2) diagram in the Settings > System Setup section later. This signal when true blocks breaker 1 close control while the operand selected by setting XCBR1 ST.LOC OPERAND is not active.

**CSWI1 Pos ctlModel**

*Range: status-only, direct-with-normal-security, sbo-with-normal-security, direct-with-enhanced-security, sbo-with-enhanced-security*

*Default: direct-with-normal-security*

This setting selects the control model clients must use to successfully control the breaker 1 signals marked BkrCSWI1.PosOpn.ctIVal and BkrCSWI1.PosCls.ctIVal on the Breaker Control Logic (Sheet 1 of 2) diagram in the Settings > System Setup section earlier. These signals force a breaker 1 three-phase trip or close control while the operand selected by setting XCBR1 ST.LOC OPERAND is not active.

**CSWI1 Pos sboTimeout**

*Range: 2 to 60 s in steps of 1 s*

*Default: 30 s*

This setting specifies the maximum time between a select and an operate command to breaker 1 via BkrCSWI1.Pos in order for the operand to be successful. This setting is only relevant when CSWI1 Pos ctlModel is sbo-with-normal-security or sbo-with-enhanced-security.

**CSWI1 Pos operTimeout**

*Range: 0.000 to 2.000 s in steps of 0.001s*

*Default: 0.100 s*

This setting applies to IEC 61850 Edition 2.

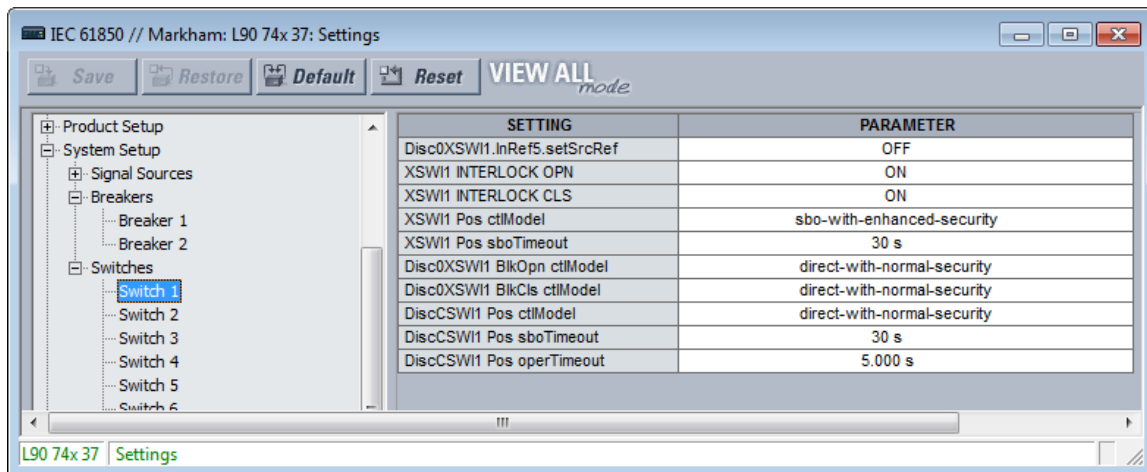
This setting specifies the maximum time between an operate command to breaker 1 via BkrCSWI1.Pos until BkrCSWI1.Pos.stVal enters the commanded state. The command terminates if the commanded state is not reached in the set time.

**Switches**

The UR disconnect switch control and status monitoring elements have certain settings that configure how the IEC 61850 protocol interacts with these elements. These settings are described in this section. See the Settings > System Setup > Disconnect Switches section later in this chapter for details on the operation of the disconnect switch control elements.

Navigate to **Settings > Product Setup > Communications > IEC 61850 > System Setup > Switches > Switch 1** to access the settings that configure the IEC 61850 protocol interface with the first disconnect switch control and status monitoring element. The settings and functionality for the others are similar.

Figure 5-41: Switch panel



#### Disc0XSWI1.InRef5.setSrcRef OPERAND

Range: any FlexLogic operand

Default: OFF

This setting is used to select a FlexLogic operand that declares to IEC 61850 services that disconnect switch 1 is selected for local control. While the selected operand is asserted, Disc0XSWI1.Loc.stVal is true and IEC 61850 commands to DiscCSWI1.Pos and Disc0XSWI1.Pos are not accepted, and a Negative Response (-Rsp) is issued with the REASON CODE of Blocked-by-switching-hierarchy.

#### XSWI1 INTERLOCK OPN

Range: any FlexLogic operand

Default: ON

This setting is used to select a FlexLogic operand that declares to IEC 61850 services that interlocking conditions are not acceptable for opening disconnect switch 1. While the selected operand is asserted, the value of DiscCILO.EnaOpn.stVal is false. If a SelectWithValue or Operate service with ctlVal false and with Check.Interlock-check true is requested of DiscCSWI1.Pos or Disc0XSWI1.Pos and the selected operand is not activated, a Negative Response (-Rsp) is issued with the REASON CODE of Blocked-by-interlocking.

#### XSWI1 INTERLOCK CLS

Range: any FlexLogic operand

Default: ON

This setting is used to select a FlexLogic operand that declares to IEC 61850 services that interlocking conditions are not acceptable for closing disconnect switch 1. While the selected operand is asserted, the value of DiscCILO.EnaCls.stVal is false. If a SelectWithValue or Operate service with ctlVal true and with Check.Interlock-check true is requested of DiscCSWI1.Pos or Disc0XSWI1.Pos and the selected operand is not activated, a Negative Response (-Rsp) is issued with the REASON CODE of Blocked-by-interlocking.

#### XSWI1 Pos ctlModel

Range: status-only, direct-with-normal-security, sbo-with-normal-security, direct-with-enhanced-security, sbo-with-enhanced-security

Default: sbo-with-enhanced-security

This setting selects the control model that clients must use to successfully control the disconnect switch 1 signals marked Disc0XCBR1.PosOpn.ctlVal and Disc0XCBR1.PosCls.ctlVal on the Disconnect Switch Logic diagram in the Settings > System Setup section later. These signals force a disconnect switch trip or close control while the operand selected by setting XSWI1 ST.LOC OPERAND is not active.

"sbo" here is select-before-operate. Enhanced security means that the G30 reports to the client the disconnect switch 1 position the end of the command sequence.

**XSWI1 Pos sboTimeout**

*Range: 2 to 60 s in steps of 1 s*

*Default: 30 s*

This setting specifies the maximum time between a select and an operate command to disconnect switch 1 signals marked Disc0XCBR1.PosOpn.ctlVal and Disc0XCBR1.PosCls.ctlVal in order for the operand to be successful. This setting is only relevant when XSWI1 Pos ctlModel is sbo-with-normal-security or sbo-with-enhanced-security.

**Disc0XSWI1 BlkOpn ctlModel**

*Range: status-only, direct-with-normal-security, sbo-with-normal-security*

*Default: direct-with-normal-security*

This setting selects the control model clients must use to successfully control the disconnect switch 1 signal marked DiscCSWI1.BlkOpn.ctlVal signal on the Disconnect Switch Logic diagram in the Settings > System Setup section later. This signal when true blocks disconnect switch 1 trip control while the operand selected by setting XSWI1 ST.LOC OPERAND is not active.

**Disc0XSWI1 BlkCls ctlModel**

*Range: status-only, direct-with-normal-security, sbo-with-normal-security*

*Default: direct-with-normal-security*

This setting selects the control model clients must use to successfully control the disconnect switch 1 signal marked DiscCSWI1.BlkCls.ctlVal signal on the Disconnect Switch Logic diagram in the Settings > System Setup section later. This signal when true blocks disconnect switch 1 close control while the operand selected by setting XSWI1 ST.LOC OPERAND is not active.

**Disc0CSWI1 Pos ctlModel**

*Range: status-only, direct-with-normal-security, sbo-with-normal-security, direct-with-enhanced-security, sbo-with-enhanced-security*

*Default: direct-with-normal-security*

This setting selects the control model clients must use to successfully control the disconnect switch 1 signals marked DiscCSWI1.PosOpn.ctlVal and DiscCSWI1.PosCls.ctlVal on the Disconnect Switch Logic diagram in the Settings > System Setup section later. These signals force a disconnect switch trip or close control while the operand selected by setting XSWI1 ST.LOC OPERAND is not active.

**Disc0CSWI1 Pos sboTimeout**

*Range: 2 to 60 s in steps of 1 s*

*Default: 30 s*

This setting specifies the maximum time between a select and an operate command to disconnect switch 1 via BkrCSWI1.Pos in order for the operand to be successful. This setting is only relevant when CSWI1 Pos ctlModel is sbo-with-normal-security or sbo-with-enhanced-security.

**Disc0CSWI1 Pos operTimeout**

*Range: 0.000 to 65.535 s in steps of 0.001s*

*Default: 5.000 s*

This setting specifies the maximum time between an operate command to disconnect switch 1 via BkrCSWI1.Pos until BkrCSWI1.Pos.stVal enters the commanded state. The command terminates if the commanded state is not reached in the set time.

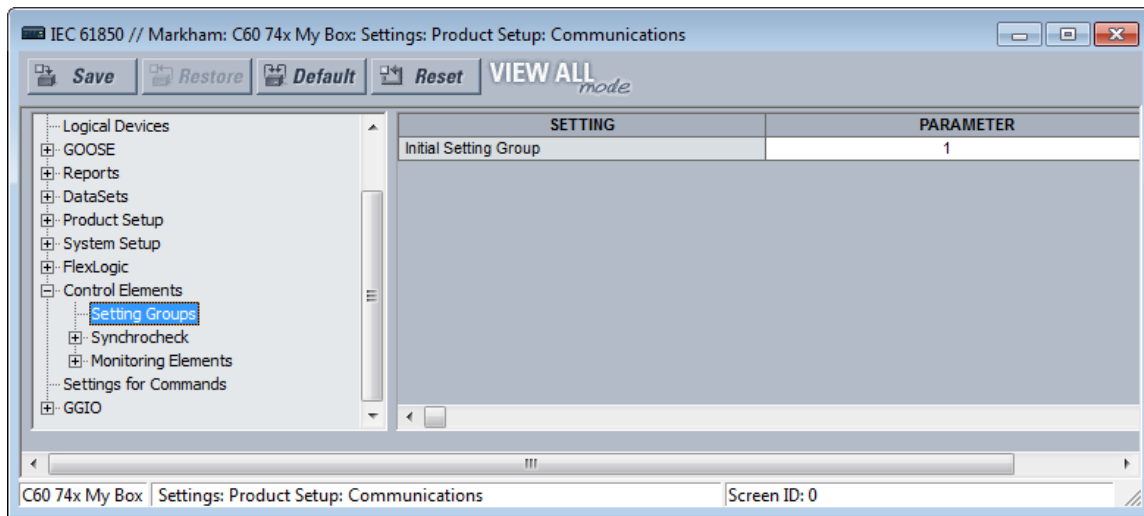
**Setting Groups**

The UR implements a setting groups element as detailed in the Control Elements > Setting Groups section of this chapter. The active setting group and the setting group open for edits can be selected via MMS commands SelectActiveSG and SelectEditSG. The setting related to these IEC 61850 commands are described here.

Navigate to **Settings > Product Setup > Communications > IEC 61850 > Control Elements > Setting Groups** to access the setting that configures the IEC 61850 setting group commands.



Figure 5-42: Setting Groups panel (Edition 2)



### Initial Setting Group

Range: 1 to 6 in steps of 1

Default: 1

The entered value sets the initial value of the non-volatile register normally controlled by the service SelectActiveSG. This initialization occurs only on the UR reboot immediately following the receipt of a valid CID file.

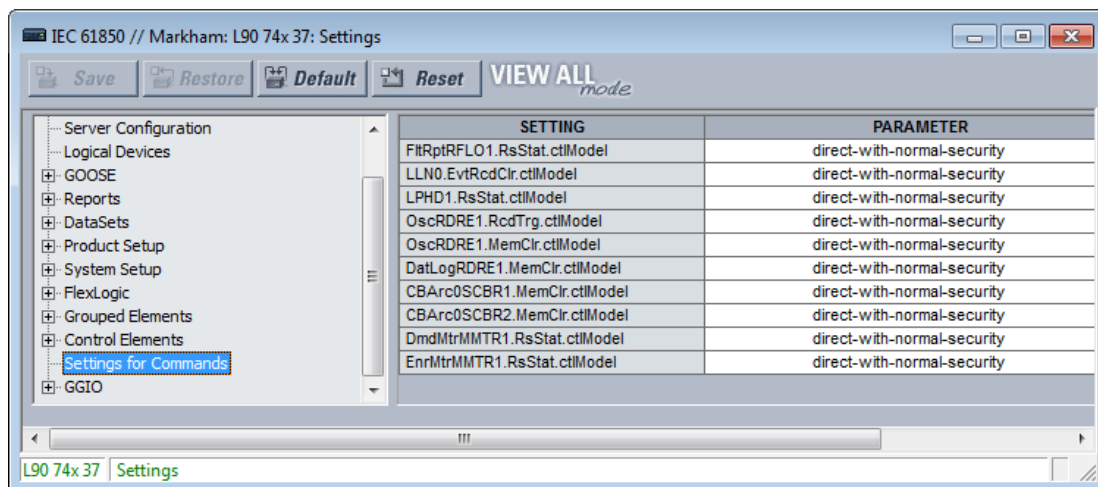
This setting is not mapped into the IEC 61850 information model, but sets the value of SettingControl element attribute actSG in SCL files.

### Commands

The UR implements a number of clear records commands as detailed in the Commands and Targets chapter of this manual. Several of these commands also can be issued via IEC 61850. The settings related to these IEC 61850 commands are described here.

Navigate to **Settings > Product Setup > Communications > IEC 61850 > Settings for Commands** to access the settings that configure the IEC 61850 protocol interface for record clear commands.

Figure 5-43: Commands panel (Edition 2)



**FltRptRFLO1.RsStatctlModel**

*Range: direct-with-normal-security, sbo-with-normal-security*

*Default: direct-with-normal-security*

This setting selects the control model clients must use to successfully control the command CLEAR FAULT REPORTS. "sbo" here is select-before-operate. Enhanced security means that the G30 reports to the client the breaker 1 position at the end of the command sequence.

**LLN0.EvtRcdClrctlModel**

*Range: direct-with-normal-security, sbo-with-normal-security*

*Default: direct-with-normal-security*

This setting selects the control model clients must use to successfully control the command CLEAR EVENT RECORDS.

**LPHD1.RsStatctlModel**

*Range: direct-with-normal-security, sbo-with-normal-security*

*Default: direct-with-normal-security*

This setting selects the control model clients must use to successfully control the command CLEAR ALL RELAY RECORDS.

**OscRDRE1.RcdTrgctlModel**

*Range: direct-with-normal-security, sbo-with-normal-security*

*Default: direct-with-normal-security*

This setting selects the control model clients must use to successfully control the command FORCE TRIGGER.

**OscRDRE1.MemClrctlModel**

*Range: direct-with-normal-security, sbo-with-normal-security*

*Default: direct-with-normal-security*

This setting selects the control model clients must use to successfully control the command CLEAR OSCILLOGRAPHY.

**DatLogRDRE1.MemClrctlModel**

*Range: direct-with-normal-security, sbo-with-normal-security*

*Default: direct-with-normal-security*

This setting selects the control model clients must use to successfully control the command CLEAR DATA LOGGER.

**CBArc0SCBR1.MemClrctlModel**

*Range: direct-with-normal-security, sbo-with-normal-security*

*Default: direct-with-normal-security*

**DmdMtrMMTR1.RsStatctlModel**

*Range: direct-with-normal-security, sbo-with-normal-security*

*Default: direct-with-normal-security*

**EnrMtrMMTR1.RsStatctlModel**

*Range: direct-with-normal-security, sbo-with-normal-security*

*Default: direct-with-normal-security*

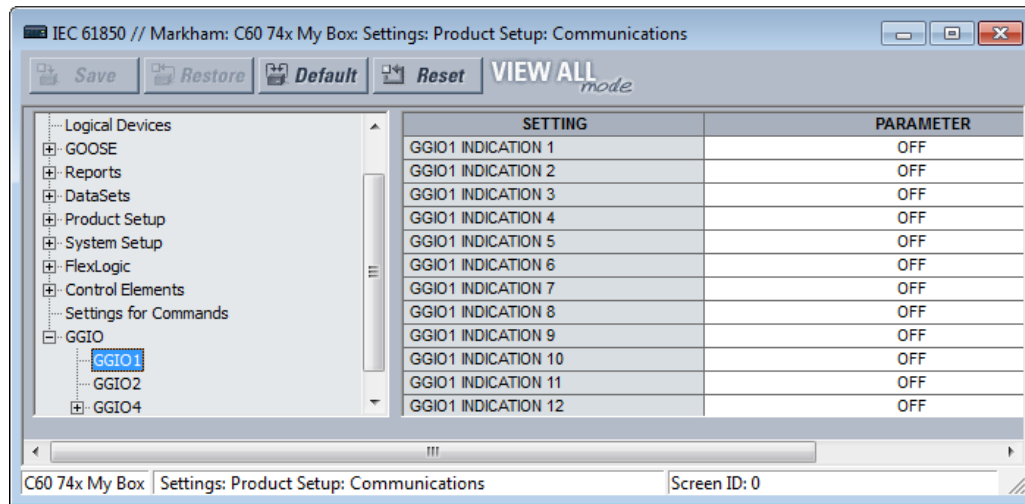
**GGIO1**

GGIO1 is a UR feature that allows up to 128 UR FlexLogic operands to be user-mapped to IEC 61850 information model data attributes.

For the value of a FlexLogic operand to be read via MMS, included in TxGOOSE messages, or included in buffered/unbuffered reports, the value must be assigned to a data attribute. GGIO1 allows those FlexLogic operands that have not yet been factory-assigned to a data attribute to be user-assigned to a generic data attribute, and thus have their values included in IEC 61850 communications.

Navigate to **Settings > Product Setup > Communications > IEC 61850 > GGIO > GGIO1** to access the settings for GGIO1.

Figure 5-44: IEC 61850 GGIO1 panel (Edition 2)

**GGIO1 INDICATION 1**

Range: any FlexLogic operand

Default: OFF

This setting selects the FlexLogic operand whose value is mapped into the IEC 61850 data attribute <LDName>/GGIO1.Ind001.stVal. See the FlexLogic section in this chapter for a list of FlexLogic operands.

**GGIO1 INDICATION 2**

Range: any FlexLogic operand

Default: OFF

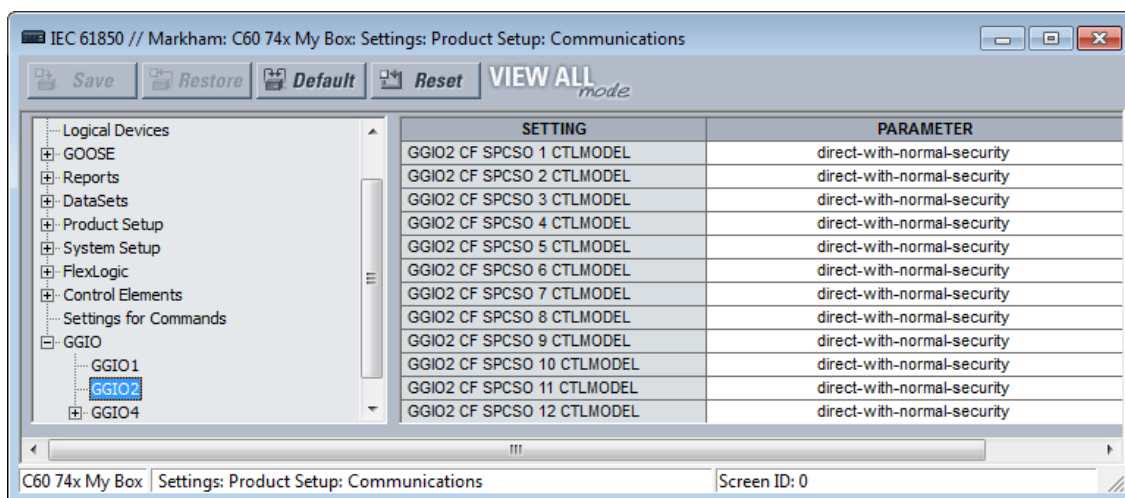
Selects the FlexLogic operand mapped to <LDName>/GGIO1.Ind002.stVal, and so on.

**GGIO2**

Virtual Inputs are controllable FlexLogic operands that can be controlled via IEC 61850 commands to GGIO2, by DNP, by Modbus, and by the UR front panel. The settings related to these IEC 61850 commands are described here.

Navigate to **Settings > Product Setup > Communications > IEC 61850 > GGIO > GGIO2** to access the settings that configure the IEC 61850 protocol interface for Virtual Input commands.

Figure 5-45: GGIO2 panel (Edition 2)



**GGIO2 CF SPCSO 1 CTLMODEL**

Range: status-only, direct-with-normal-security, sbo-with-normal-security  
 Default: direct-with-normal-security

This setting selects the control model clients must use to successfully control Virtual Input 1. "sbo" here is select-before-operate.

**GGIO2 CF SPCSO 2 CTLMODEL**

Range: status-only, direct-with-normal-security, sbo-with-normal-security  
 Default: direct-with-normal-security

Selects the control model for Virtual Input 2, and so on.

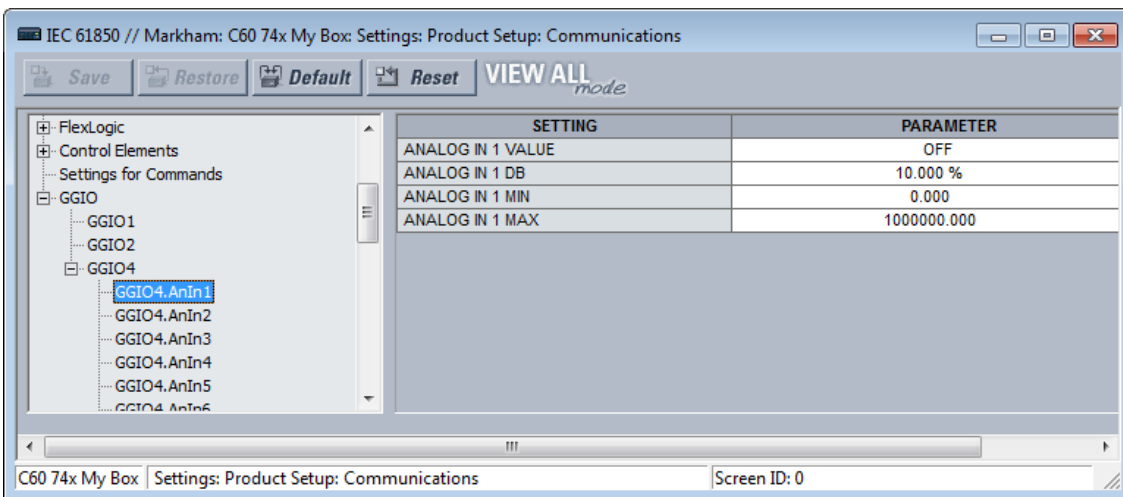
**GGIO4**

GGIO4 is a UR feature that allows up to 32 UR FlexAnalog operands to be user-mapped to an IEC 61850 information model data attribute.

For the value of a FlexAnalog operand to be read via MMS, included in TxGOOSE messages, or included in buffered/unbuffered reports, the value must be assigned to a data attribute. GGIO4 allows those FlexAnalog operands that have not yet been factory-assigned to a data attribute to be user-assigned to a generic data attribute, and thus have their values included in IEC 61850 communications.

Navigate to **Settings > Product Setup > Communications > IEC 61850 > GGIO > GGIO4 > GGIO4.AnIn1** to access the settings for the first GGIO4 value. The settings and functionality for the others are similar.

Figure 5-46: GGIO4 panel (Edition 2)



**ANALOG IN 1 VALUE**

Range: any FlexAnalog operand  
 Default: OFF

This setting selects the FlexAnalog operand whose value is mapped into the IEC 61850 data attribute <LDName>/GGIO4.AnIn01.instMag.f. The value of the FlexAnalog operand is converted automatically to the format and scaling required by the standard, that is to say primary amperes, primary volts, and so on. See Appendix A for a list of FlexAnalog operands.

**ANALOG IN 1 DB**

*Range: 0.000 to 100.000% in steps of 0.001*

*Default: 0.000%*

This setting specifies the deadband for the **ANALOG IN 1 VALUE**. The deadband is used to determine when to update the deadbanded magnitude from the instantaneous magnitude. The deadband is a percentage of the difference between the "max." and "min." values. Here, the "max." and "min." are as specified by the settings **ANALOG IN 1 MAX** and **ANALOG IN 1 MIN**.

See the Deadband Settings section earlier for a description of deadbanded values.

**ANALOG IN 1 MIN**

*Range: -1000000000.000 to 1000000000.000 in steps of 0.001*

*Default: 0.000*

This setting specifies the "min." value used in deadband calculations. The scaling of this setting is the same as used by <LDName>/GGIO4.AnIn01.instMag.f. This setting is stored as an IEEE 754 / IEC 60559 floating point number. Because of the large range of this setting, not all possible values can be stored. Some values are rounded to the closest possible floating point number.

**ANALOG IN 1 MAX**

*Range: -1000000000.000 to 1000000000.000 in steps of 0.001*

*Default: 1000000.000*

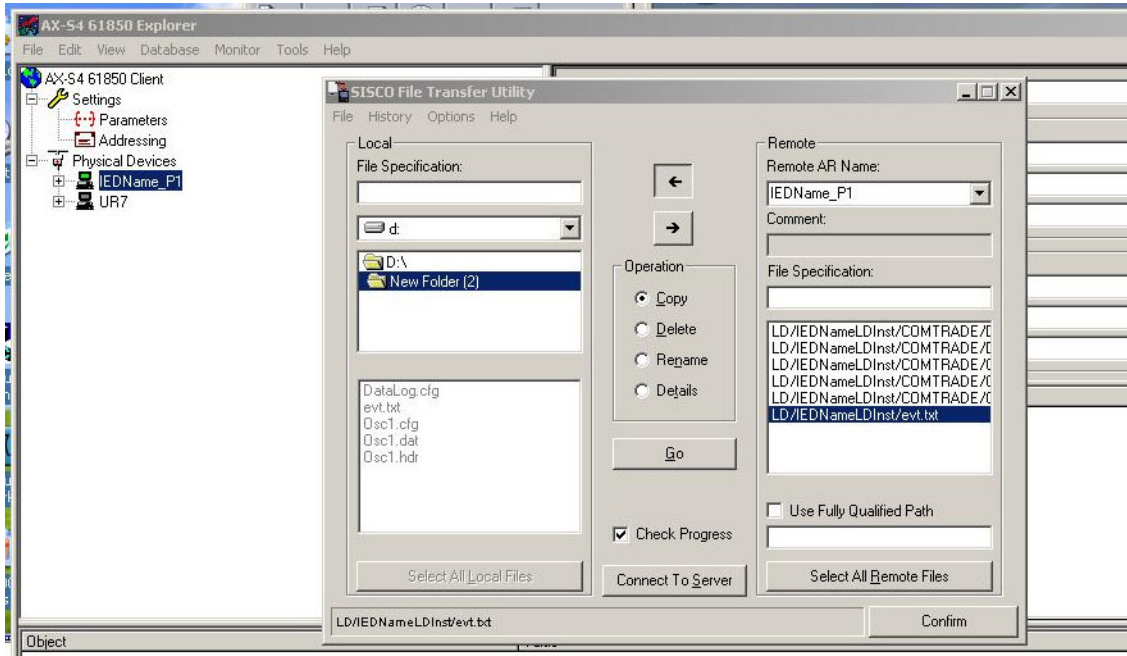
This setting specifies the "max." value used in deadband calculations. The scaling of this setting is the same as used by <LDName>/GGIO4.AnIn01.instMag.f. This setting is stored as an IEEE 754 / IEC 60559 floating point number. Because of the large range of this setting, not all possible values can be stored. Some values are rounded to the closest possible floating point number.

**File transfer by IEC 61850**

The G30 supports file transfer by IEC 61850. The approach is as follows, using the SISCO AX-S4 61850 client software as an example.

1. In the AX-S4 61850 Explorer window, click the **Tools** menu and access the SISCO File Transfer Utility.
2. Select the **Remote AR Name** from the drop-down list. Available files appear in the **File Specification** area on the right side of the window.
3. With the **Copy** option active, select a file to transfer and click the **Go** button. The file is copied and displays in the **Local** list on the left side of the window.
4. Repeat the process to transfer any other files.

Figure 5-47: File transfer by IEC 61850



5

5.3.5.13 Web server HTTP protocol

SETTINGS ⇒ PRODUCT SETUP ⇒ COMMUNICATIONS ⇒ WEB SERVER HTTP PROTOCOL

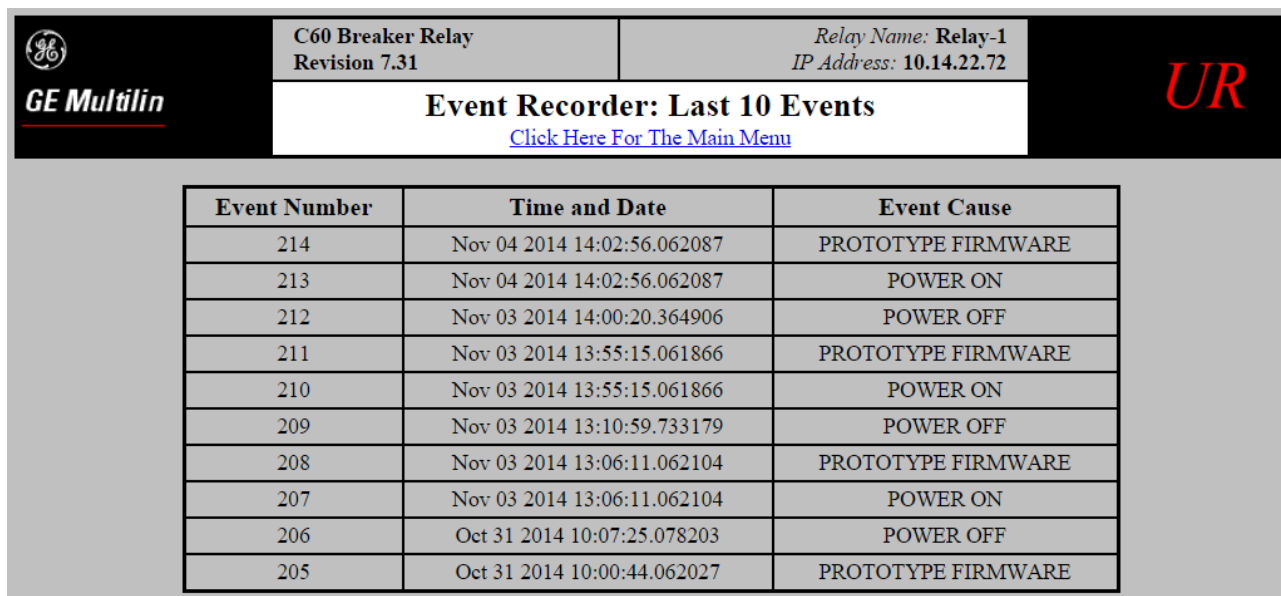
<ul style="list-style-type: none"> <li>■ WEB SERVER</li> <li>■ HTTP PROTOCOL</li> </ul>	↔	<b>HTTP TCP PORT NUMBER(80): 80</b>	Range: 0 to 65535 in steps of 1
---	---	-------------------------------------	---------------------------------

The G30 contains an embedded web server and can display pages in a web browser. The web pages are organized as a series of menus that can be accessed starting at the G30 “Main Menu.” Web pages are read-only and are available showing DNP and IEC 60870-5-104 points lists, Modbus registers, event records, fault reports, and so on. First connect the G30 and a computer to an Ethernet network, then enter the IP address of the G30 Ethernet port in a web browser.

To close the port, set the port number to 0.

Any change takes effect when the G30 is restarted.

Figure 5-48: Example of UR web page showing event records



Event Number	Time and Date	Event Cause
214	Nov 04 2014 14:02:56.062087	PROTOTYPE FIRMWARE
213	Nov 04 2014 14:02:56.062087	POWER ON
212	Nov 03 2014 14:00:20.364906	POWER OFF
211	Nov 03 2014 13:55:15.061866	PROTOTYPE FIRMWARE
210	Nov 03 2014 13:55:15.061866	POWER ON
209	Nov 03 2014 13:10:59.733179	POWER OFF
208	Nov 03 2014 13:06:11.062104	PROTOTYPE FIRMWARE
207	Nov 03 2014 13:06:11.062104	POWER ON
206	Oct 31 2014 10:07:25.078203	POWER OFF
205	Oct 31 2014 10:00:44.062027	PROTOTYPE FIRMWARE



Do not set more than one protocol to the same TCP/UDP port number, as this results in unreliable operation of those protocols.

### 5.3.5.14 TFTP protocol

SETTINGS ⇒ PRODUCT SETUP ⇒ COMMUNICATIONS ⇒ TFTP PROTOCOL

<input checked="" type="checkbox"/> TFTP PROTOCOL	↔	TFTP MAIN UDP PORT NUMBER(69): 69	Range: 0 to 65535 in steps of 1
<input checked="" type="checkbox"/>	↕	TFTP DATA UDP PORT 1 NUMBER: 0	Range: 0 to 65535 in steps of 1
	↑	TFTP DATA UDP PORT 2 NUMBER: 0	Range: 0 to 65535 in steps of 1

The Trivial File Transfer Protocol (TFTP) can be used to transfer files from the G30 over a network. The G30 operates as a TFTP server. TFTP client software is available from various sources, including Microsoft Windows NT. The dir.txt file obtained from the G30 contains a list and description of all available files, for example event records and oscillography.

The "put" function is not for security reasons. You can enter a "get" command but not a "put" command.

**TFTP MAIN UDP PORT NUMBER** — To close the port, set the port number to 0. Any change takes effect when the G30 is restarted.



Do not set more than one protocol to the same TCP/UDP port number, as this results in unreliable operation of those protocols.

### 5.3.5.15 IEC 60870-5-104 protocol

SETTINGS ⇒ PRODUCT SETUP ⇒ COMMUNICATIONS ⇒ IEC 60870-5-104 PROTOCOL

<input checked="" type="checkbox"/> IEC 60870-5-104 <input checked="" type="checkbox"/> PROTOCOL	↔	IEC TCP PORT NUMBER: 2404	Range: 0 to 65535 in steps of 1
	↕	<input checked="" type="checkbox"/> IEC NETWORK <input checked="" type="checkbox"/> CLIENT ADDRESSES	See below

⇕	IEC COMMON ADDRESS OF ASDU: 0	Range: 0 to 65535 in steps of 1
⇕	IEC CYCLIC DATA PERIOD: 60 s	Range: 1 to 65535 s in steps of 1
⇕	IEC CURRENT DEFAULT THRESHOLD: 30000	Range: 0 to 65535 in steps of 1
⇕	IEC VOLTAGE DEFAULT THRESHOLD: 30000	Range: 0 to 65535 in steps of 1
⇕	IEC POWER DEFAULT THRESHOLD: 30000	Range: 0 to 65535 in steps of 1
⇕	IEC ENERGY DEFAULT THRESHOLD: 30000	Range: 0 to 65535 in steps of 1
⇕	IEC PF DEFAULT THRESHOLD: 1.00	Range: 0.00 to 1.00
⇕	IEC OTHER DEFAULT THRESHOLD: 30000	Range: 0 to 65535 in steps of 1
⇕	IEC REDUNDANCY ENABLED: No	Range: No, Yes

IEC 60870-5-104 is a transmission protocol for network access, specifically for communication between a control station and substation over a TCP/IP network.

The G30 supports the IEC 60870-5-104 protocol. This protocol is enabled when the **SETTINGS ⇒ PRODUCT SETUP ⇒ COMMUNICATIONS ⇒ PROTOCOL** setting is set to IEC 60870-5-104. The G30 can be used as an IEC 60870-5-104 slave device connected to a maximum of two masters (usually either an RTU or a SCADA master station). Since the G30 maintains two sets of IEC 60870-5-104 data change buffers, ideally no more than two masters actively communicate with the G30 at one time.

The **IEC ----- DEFAULT THRESHOLD** settings are used to determine when to trigger spontaneous responses containing M\_ME\_NC\_1 analog data. These settings group the G30 analog data into types: current, voltage, power, energy, and other. Each setting represents the default threshold value for all M\_ME\_NC\_1 analog points of that type. For example, to trigger spontaneous responses from the G30 when any current values change by 15 A, the **IEC CURRENT DEFAULT THRESHOLD** setting is set to 15. Note that these settings are the default values of the deadbands. P\_ME\_NC\_1 (parameter of measured value, short floating point value) points can be used to change threshold values, from the default, for each individual M\_ME\_NC\_1 analog point. Whenever power is removed and re-applied to the G30, the default thresholds are in effect.

The **IEC REDUNDANCY** setting decides whether multiple client connections are accepted or not. If redundancy is set to Yes, two simultaneous connections can be active at any given time.

**IEC TCP PORT NUMBER** — To close the port, set the port number to 0. Any change takes effect when the G30 is restarted.

**IEC COMMON ADDRESS OF ASDU** — The change takes effect when the G30 is restarted.

**IEC CYCLIC DATA PERIOD** — The change takes effect when the G30 is restarted.



Do not set more than one protocol to the same TCP/UDP port number, as this results in unreliable operation of those protocols.

**SETTINGS ⇒ PRODUCT SETUP ⇒ COMMUNICATIONS ⇒ IEC 60870-5-104 PROTOCOL ⇒ IEC NETWORK CLIENT ADDRESSES**

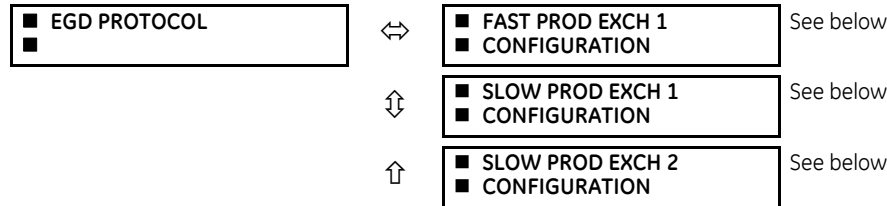
<input checked="" type="checkbox"/> IEC NETWORK <input checked="" type="checkbox"/> CLIENT ADDRESSES	⇕	CLIENT ADDRESS 1: 0.0.0.0	Range: standard IPV4 address format
		⇓	
	⇕	CLIENT ADDRESS 5: 0.0.0.0	Range: standard IPV4 address format



The G30 can specify a maximum of five clients for its IEC 104 connections. These are IP addresses for the controllers to which the G30 can connect. A maximum of two simultaneous connections are supported at any given time.

### 5.3.5.16 EGD protocol

SETTINGS ⇒ PRODUCT SETUP ⇒ COMMUNICATIONS ⇒ EGD PROTOCOL



The G30 is provided with optional Ethernet Global Data (EGD) communications capability. This feature is specified as a software option at the time of ordering. See the Order Codes section in chapter 2 for details.

Ethernet Global Data (EGD) is a suite of protocols used for the real-time transfer of data for display and control purposes. The relay can be configured to 'produce' EGD data exchanges, and other devices can be configured to 'consume' EGD data exchanges. The number of produced exchanges (up to three), the data items in each exchange (up to 50), and the exchange production rate can be configured.

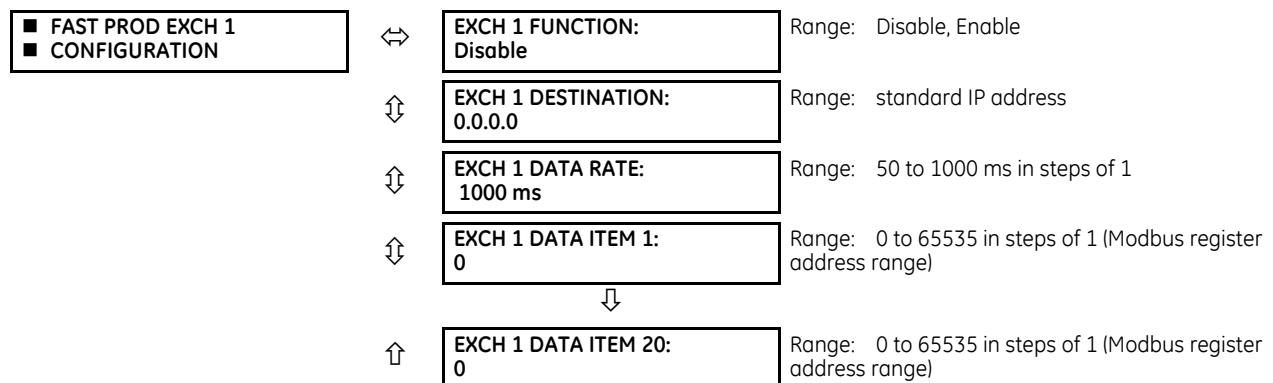
The relay supports one fast EGD exchange and two slow EGD exchanges. There are 20 data items in the fast-produced EGD exchange and 50 data items in each slow-produced exchange.

EGD cannot be used to transfer data between UR series relays. The relay supports EGD production only. An EGD exchange is not transmitted unless the destination address is non-zero, and at least the first data item address is set to a valid Modbus register address. The default setting value of "0" is considered invalid.

Fast exchanges (50 to 1000 ms) are generally used in control schemes. The G30 has one fast exchange (exchange 1) and two slow exchanges (exchange 2 and 3).

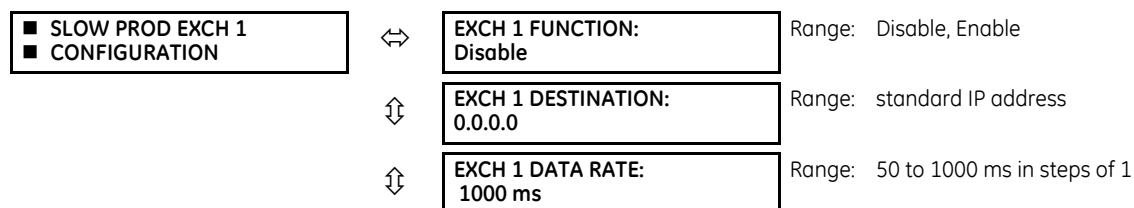
The settings menu for the fast EGD exchange follows.

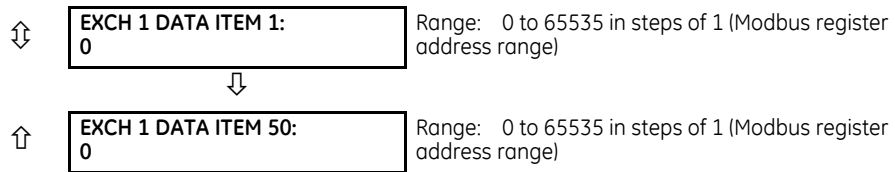
SETTINGS ⇒ PRODUCT SETUP ⇒ COMMUNICATIONS ⇒ EGD PROTOCOL ⇒ FAST PROD EXCH 1 CONFIGURATION



The settings menu for the slow EGD exchanges follows.

SETTINGS ⇒ PRODUCT SETUP ⇒ COMMUNICATIONS ⇒ EGD PROTOCOL ⇒ SLOW PROD EXCH 1(2) CONFIGURATION





Slow EGD exchanges (500 to 1000 ms) are generally used for the transfer and display of data items. The settings for the fast and slow exchanges are as follows.

**EXCH 1 DESTINATION** — This setting specifies the destination IP address of the produced EGD exchange. This is usually unicast or broadcast.

**EXCH 1 DATA RATE** — This setting specifies the rate at which this EGD exchange is transmitted. If the setting is 50 ms, the exchange data is updated and sent once every 50 ms. If the setting is 1000 ms, the exchange data is updated and sent once per second. EGD exchange 1 has a setting range of 50 to 1000 ms. Exchanges 2 and 3 have a setting range of 500 to 1000 ms.

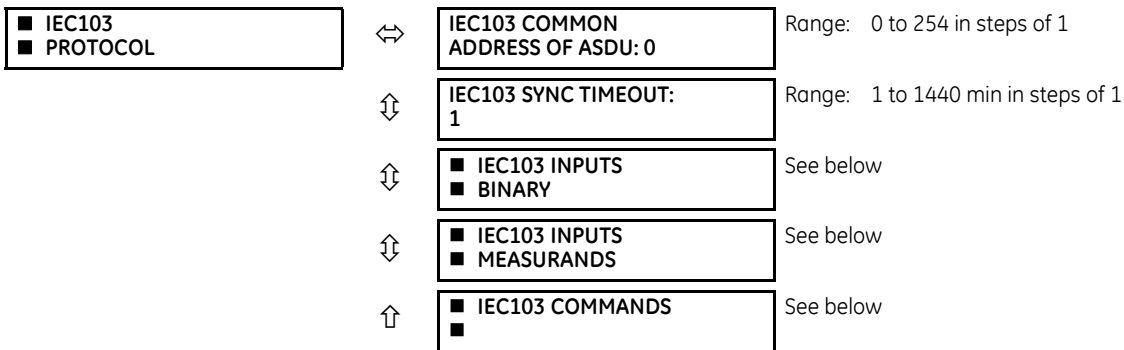
**EXCH 1 DATA ITEM 1 to 20/50** — These settings specify the data items that are part of this EGD exchange. Almost any data from the G30 memory map can be configured to be included in an EGD exchange. The settings are the starting Modbus register address for the data item in decimal format. See the Modbus memory map in the UR Series Communications Guide for details. The Modbus memory map display shows addresses in hexadecimal format. Convert these hex values to decimal format before entering them as values for these setpoints.

To select a data item to be part of an exchange, it is only necessary to choose the starting Modbus address of the item. That is, for items occupying more than one Modbus register (for example, 32 bit integers and floating point values), only the first Modbus address is required. The EGD exchange configured with these settings contains the data items up to the first setting that contains a Modbus address with no data, or 0. That is, if the first three settings contain valid Modbus addresses and the fourth is 0, the produced EGD exchange contains three data items.

5

### 5.3.5.17 IEC 60870-5-103 protocol

SETTINGS ⇒ PRODUCT SETUP ⇒ ↓ COMMUNICATIONS ⇒ ↓ IEC 60870-5-103



The G30 is provided with optional IEC 60870-5-103 communications capability. This feature is specified as a software option at the time of ordering. See the Order Codes section in chapter 2 for details.

IEC 60870-5-103 is a companion standard to the IEC 60870-5 suite of standards for transmission protocols. It defines messages and procedures for interoperability between protection equipment and devices of a control system in a substation for communicating on a serial line.

The IEC 60870-5-103 protocol is enabled when the **SETTINGS ⇒ PRODUCT SETUP ⇒ ↓ COMMUNICATIONS ⇒ PROTOCOL** setting is set to IEC 60870-5-103.

The IEC 60870-5-103 is an unbalanced (master-slave) protocol for coded-bit serial communication, exchanging information with a control system. In the context of this protocol, the protection equipment is the slave and the control system is the master. The communication is based on a point-to-point principle. The master must be able to interpret the IEC 60870-5-103 communication messages.

The UR implementation of IEC 60870-5-103 consists of the following functions:

- Report binary inputs
- Report analog values (measurands)
- Commands
- Time synchronization

The RS485 port supports IEC 60870-5-103.

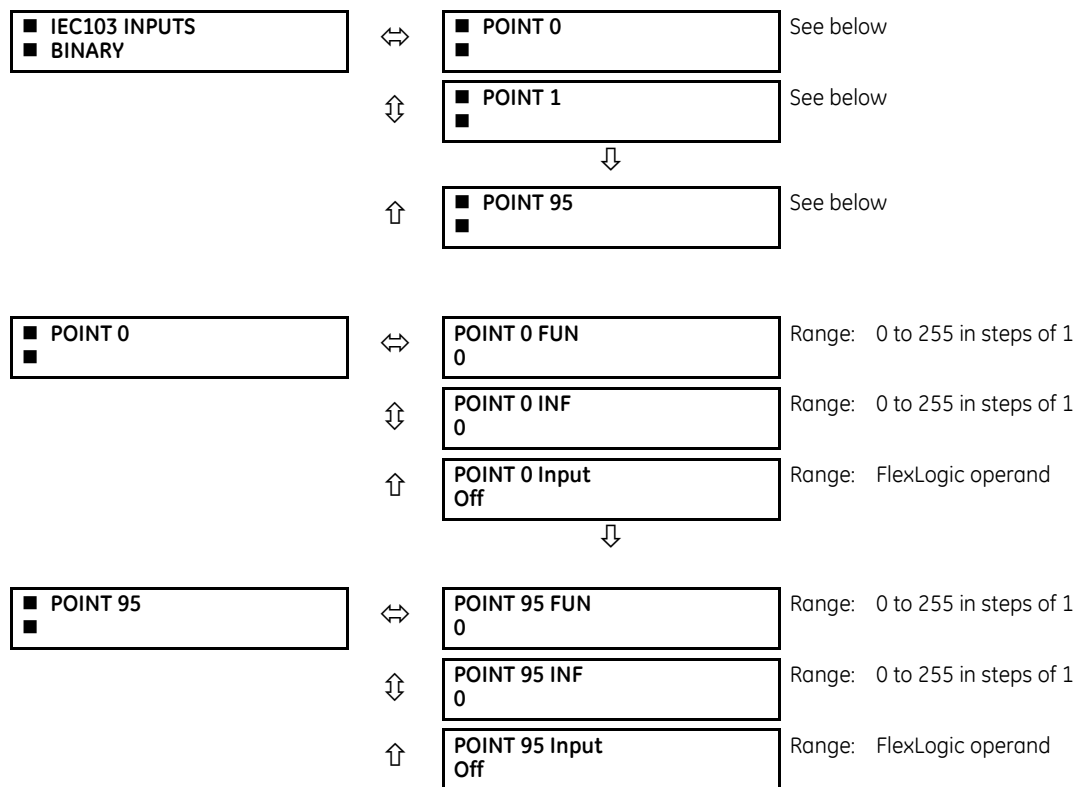
The UR Family Communications Guide contains more information on the protocol.

**IEC103 COMMON ADDRESS OF ASDU** — This setting uniquely defines this G30 on the serial line. Select an ID between 0 and 254. This ID does not need to be in sequential order for all stations that communicate with a controller, but it is recommended. Note that RS485 only allows a maximum of 32 slave stations on a communication line, so the entire range of 254 addresses is never exhausted.

**IEC103 SYNC TIMEOUT** — This setting defines the time that the G30 waits for a synchronization message. The G30 synchronizes its clock using all available sources, with the source syncing more frequently overwriting the time of the other sources. Since the synchronization message received from the IEC 60870-5-103 master is less frequent than IRIG-B, PTP, or SNTP, its time is overwritten by these three sources, if any of them is active. If the synchronization timeout occurs and none of IRIG-B, PTP, or SNTP is active, the G30 sets the invalid bit in the time stamp of a time-tagged message.

The settings for the remaining menus are outlined as follows.

**SETTINGS ⇒ PRODUCT SETUP ⇒ COMMUNICATIONS ⇒ IEC 60870-5-103 ⇒ IEC103 INPUTS BINARY**



The binary input points are mapped using elements from a list of possible FlexLogic operands. A maximum of 96 binary inputs (points) can be mapped this way.

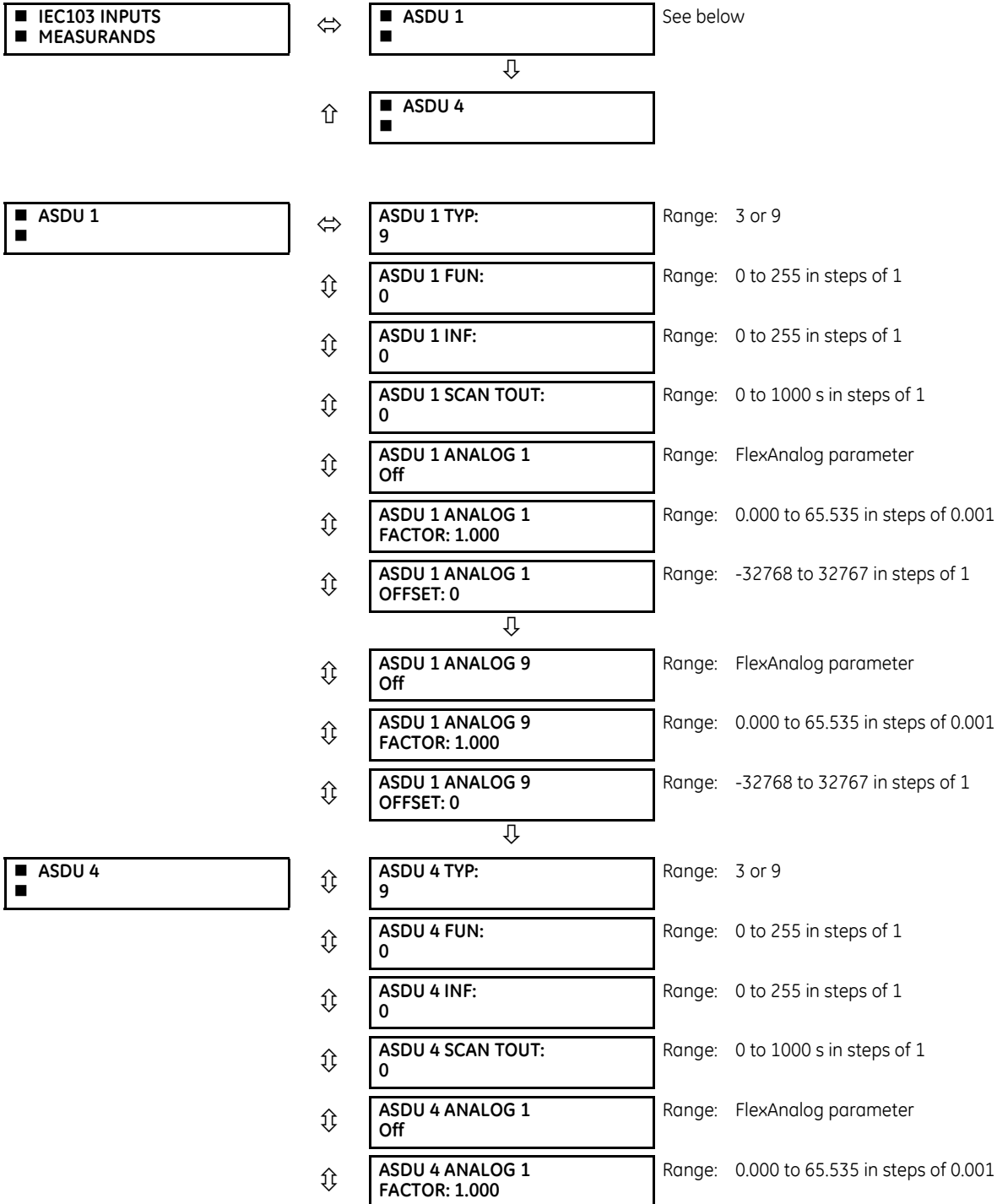
The IEC 60870-5-103 point list always starts with point 0 and ends at the first "Off" value. Since the IEC 60870-5-103 point list must be in a continuous block, any points assigned after the first "Off" point are ignored.

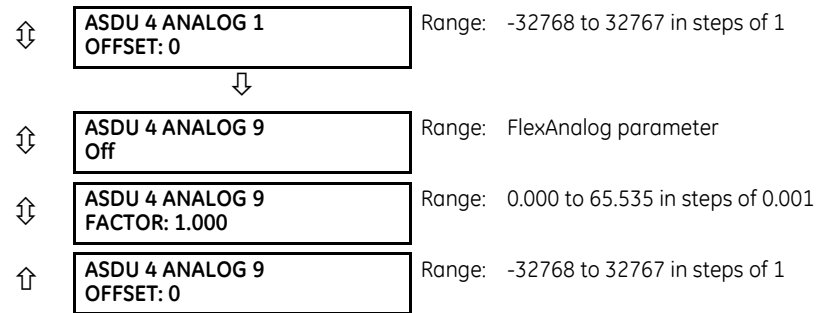
For each defined point, set appropriate values for the Function Type (FUN) and Information Number (INF), which form the Information Object Identifier field of the ASDU, as defined in IEC 60870-5-103.

The binary input points are sent as Class 1 data. They are sent either as a response to a general interrogation received from the controller or reported spontaneously. Spontaneous transmission occurs as a response to cyclic Class 2 requests. If the G30 wants to transmit Class 1 data at that time, it demands access for Class 1 data transmission (ACD=1 in the control field of the response).

For any change to take effect, restart the relay.

SETTINGS ⇒ PRODUCT SETUP ⇒ COMMUNICATIONS ⇒ IEC 60870-5-103 ⇒ IEC103 INPUTS MEASURANDS





The configuration menu allows a maximum of four ASDUs containing measurands.

Measurands are sent as a response to Class 2 requests, which are cyclic requests coming from the master.

**TYPE IDENTIFICATION (TYP)** — The configuration field TYP indicates how many measurands are present in the corresponding ASDU. Each ASDU can take either 4 or 9 measurands maximum, depending on the type identification (3 respectively 9). For any change to take effect, restart the relay.

**FUNCTION TYPE (FUN)** and **INFORMATION NUMBER (INF)** — These two fields form the Information Object Identifier of the ASDU as defined in IEC 60870-103. For any change to take effect, restart the relay.

**SCAN TIMEOUT (SCAN TOUT)** — This is the cyclic period used by the G30 to decide when a measurand ASDU is included in a response. The measurand is sent as response to a Class 2 request when the corresponding timeout expires. The default value 0 means 500 ms.

**ANALOG #** — This field contains the actual measurand to be sent in the response to the master. The measurands can be mapped using elements from a list of FlexAnalog operands. The measurands sent are voltage, current, power, power factor, and frequency. If any other FlexAnalog is chosen, the G30 sends 0 instead of its value. Note that the power is transmitted in KW, not W. Measurands are transmitted as ASDU 3 or ASDU 9 (type identification value set to measurands I, respectively measurands II).

Each IEC 60870-5-103 measurands list ends at the first unconfigured ("Off") value. Any measurand assigned after the first "Off" value is ignored.

At least one measurand per ASDU must be configured in order to configure the following ASDU. For example, the user can configure only one measurand for each ASDU, but the user is not allowed to skip ASDU 2 and configure measurands in ASDU 3.

For any change to take effect, restart the relay.

**ANALOG # FACTOR** and **OFFSET** — For each measurand included in the ASDU, a factor and offset also can be configured. The factor and offset allow for scaling to be performed on measurands. The final measurement sent to the IEC 60870-103 master is then "a\*x + b," where x is the measurand, a is the multiplying factor and b is the offset. The master has to perform the reversed operation in order to retrieve the actual value if such scaling is done. By default a = 1 and b = 0, so no scaling is done if these values are left at their defaults. Examples of when scaling is appropriate are as follows:

- If the measured value contains decimals and it is important to preserve the resolution. Since the format for transmitting the measurand does not permit decimals, a factor  $a > 1$  can be applied before transmission. For example, a frequency  $F = 59.9\text{Hz}$  can be transmitted as  $F_t = 10 * F = 10 * 59.9 = 599$ . In this case  $a = 10$ ,  $b = 0$ . The master receives 599 and has to divide by 10 to retrieve the real value 59.9.
- If the measured value is larger than what fits in the format defined in IEC 103. The format defined in the standard allows for signed integers up to 4095. By offsetting, unsigned integers up to  $4096 + 4095 = 8191$  are supported. Scaling using factors  $< 1$  can be required in such cases. The calculation is outlined in the IEC 60870-5-103 chapter of the UR Family Communications Guide. Two examples follow, where you decide factors a and b.

**Example 1:** Nominal power  $P_n = 100\text{ MW} = 100000\text{ KW}$  (power is transmitted in KW)

Since P can be both positive and negative:

$$\begin{aligned} \text{Transmitted power } P_t &= (4095 / (P_n * 2.4)) * P = (4095 / (100000 * 2.4)) * P \\ &= 0.017 * P \end{aligned}$$

$$a = 0.017$$

$$b = 0$$

$$P_t = 0.017 * P$$

For a max power 100000 KW \* 2.4 = 240000 KW, we transmit

$$P_t = 0.017 * 240000 = 4080$$

A value above 240 MW is indicated by overflow.

**Example 2:** Nominal voltage  $V_n = 500000$  V

Since RMS voltage  $V$  can be only positive:

$$\begin{aligned} \text{Transmitted voltage } V_t &= (8191/(V_n * 2.4)) * V - 4096 = \\ &= (8191/(500000 * 2.4)) * V - 4096 = 0.0068 * V - 4096 \\ a &= 0.0068 \end{aligned}$$

Since the step is in increments of 0.001, we round it at:

$$a = 0.006$$

$$b = -4096$$

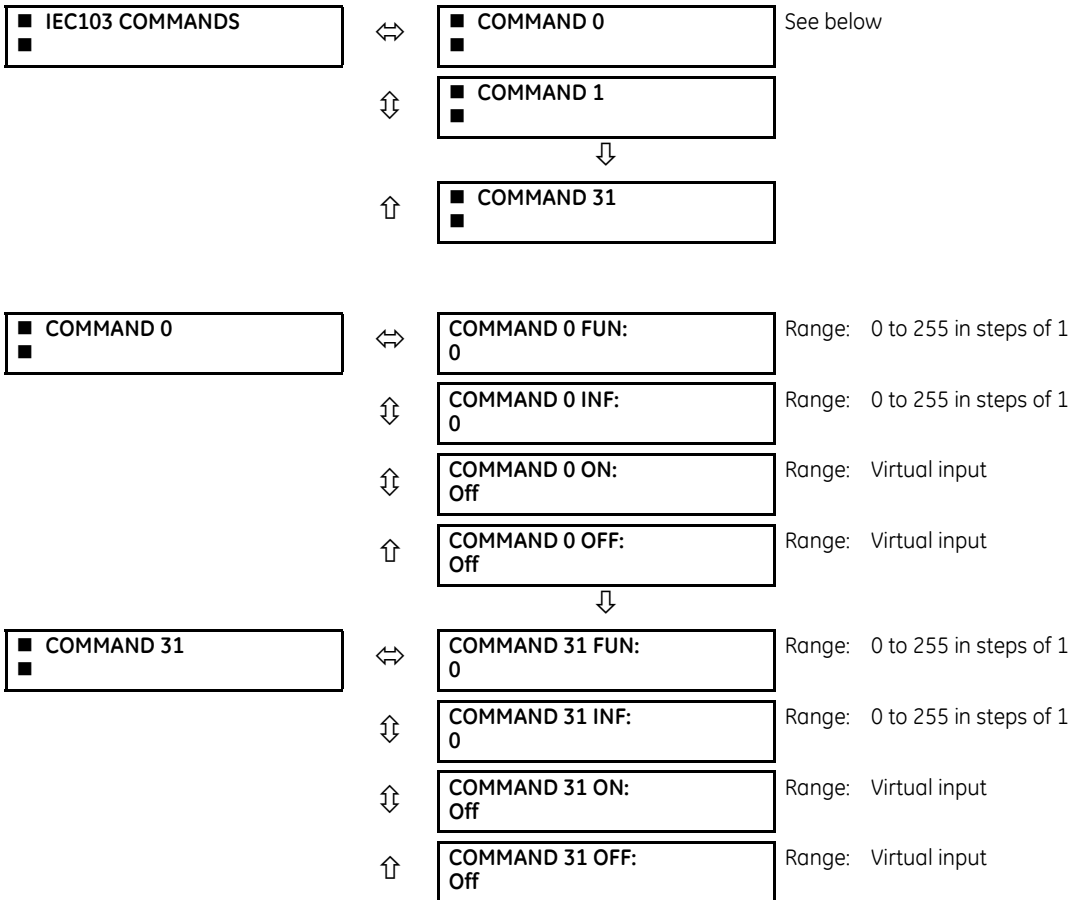
$$V_t = 0.006 * V - 4096$$

For max voltage 500000 V \* 2.4 = 1200000 V, we transmit

$$V_t = 0.006 * 1200000 - 4096 = 7200 - 4096 = 3104$$

SETTINGS ⇒ PRODUCT SETUP ⇒ COMMUNICATIONS ⇒ IEC 60870-5-103 ⇒ IEC103 COMMANDS

5



Commands are received as General Command (Type Identification 20). The user can configure the action to perform when an ASDU command comes.

A list of available mappings is provided on the G30. This includes 64 virtual inputs (see the following table). The ON and OFF for the same ASDU command can be mapped to different virtual inputs.

Each command is identified by the unique combination made by the function type (FUN) and information number (INF). If the master sends an ASDU command that does not have the FUN and INF of any configured command, the relay rejects it.

**Table 5-12: Commands mapping table**

Description	Value
Off	0
Virtual Input 1	1
Virtual Input 2	2
...	...
Virtual Input 64	64

For any change to take effect, restart the relay.

### 5.3.5.18 USB port

SETTINGS ⇒ PRODUCT SETUP ⇒ ⚙ COMMUNICATIONS ⇒ ⚙ USB 2.0

USB 2.0

↔

USB DEVICE PORT  
 FUNCTION: Enabled

Range: Disabled, Enabled



This setting applies to the USB port on the graphical front panel.

This setting enables/disables the USB port on the graphical front panel. When the port function is "Enabled," a standard USB serial cable allows a computer running the EnerVista UR Setup software to retrieve, display, and write settings either individually or collectively, to display status and actual values, to initiate controls, and to retrieve and display event records, oscillography records, data logger records, and disturbance records. Installation of the EnerVista software automatically installs the drivers required to use this USB port.

DNP is not available using the USB port on the graphical front panel.

### 5.3.6 Modbus user map

SETTINGS ⇒ PRODUCT SETUP ⇒ ⚙ MODBUS USER MAP

MODBUS USER MAP

↔

ADDRESS 1: 0  
 VALUE: 0

Range: 0 to 65535 in steps of 1

↓

↑

ADDRESS 256: 0  
 VALUE: 0

Range: 0 to 65535 in steps of 1

The Modbus user map provides read-only access for up to 256 registers. To obtain a memory map value, enter the address in the **ADDRESS** line (converted from hex to decimal format). The corresponding value (if programmed) displays in the **VALUE** line. A value of "0" in subsequent register **ADDRESS** lines automatically returns values for the previous **ADDRESS** lines incremented by 1. An address value of "0" in the initial register means "none" and values of "0" display for all registers. Different **ADDRESS** values can be entered as required in any of the register positions.

The UR Family Communications Guide outlines the Modbus memory map. The map is also viewable in a web browser; enter the IP address of the G30 in a web browser and click the option.

### 5.3.7 Real time clock

#### 5.3.7.1 Menu

SETTINGS ⇒ PRODUCT SETUP ⇒ REAL TIME CLOCK

<ul style="list-style-type: none"> <li>■ REAL TIME</li> <li>■ CLOCK</li> </ul>	↔	<b>SYNCHRONIZING SOURCE:</b> None	Range: None, PP/IRIG-B/PTP/Other, IRIG-B/PP/PTP/Other, PP/PTP/IRIG-B/Other
	↕	<b>REAL TIME CLOCK EVENTS:</b> Disabled	Range: Enabled, Disabled
	↕	<b>IRIG-B SIGNAL TYPE:</b> None	Range: None, DC Shift, Amplitude Modulated
	↕	<ul style="list-style-type: none"> <li>■ PRECISION TIME</li> <li>■ PROTOCOL (1588)</li> </ul>	See below
	↕	<ul style="list-style-type: none"> <li>■ SNTP PROTOCOL</li> <li>■</li> </ul>	See below
	↑	<ul style="list-style-type: none"> <li>■ LOCAL TIME</li> <li>■</li> </ul>	See below

The relay contains a real time clock (RTC) to create time stamps for communications protocols as well as for historical data, such as event records and oscillography. When the relay restarts, the RTC initializes from an onboard battery-backed clock, which has the same accuracy as an electronic watch, approximately ±1 minute per month (~23 ppm). Once the RTC is synchronized with the Precision Time Protocol (PTP), IRIG-B, or SNTP, its accuracy approaches that of the synchronizing time delivered to the relay. While the RTC is not synchronized via PTP or IRIG-B, or the relay determines that it has an offset possibly greater than 10 μs from the international time standard, the **CLOCK UNSYNCHRONIZED** FlexLogic operand is activated.

The **SYNCHRONIZING SOURCE** setting displays in the software when the relay includes the IEEE 1588 software option. The setting configures the priority sequence of the time synchronization source, to determine which of the available external time sources to use for time synchronization. A setting of None causes the RTC and the synchrophasor clock to free-run, and the clock can be changed from the front panel or from communications protocols. A setting of PP/IRIG-B/PTP/Other, IRIG-B/PP/PTP/Other, or PP/PTP/IRIG-B/Other causes the relay to track the first source named that is enabled and operational, or free-run if none of these are available. Here, PP means a time source that is strictly compliant with PP, PTP means a time source that is not strictly compliant with PP, and Other means any less precise source (SNTP, IEC 103, IEC 104, Modbus, or DNP). When a time source fails or recovers, the relay automatically transfers synchronization as required by this setting.

When the relay does not have the IEEE 1588 software option and this setting does not display, it uses IRIG-B when enabled and operational, then failing that SNTP when configured and operational, and otherwise it free-runs unless the clock is changed from the front panel or from communications protocols.

Setup for IRIG-B is illustrated in the Installation chapter.

For the Other protocols, whenever a time synchronization message is received through any of the active protocols, the G30 clock updates. However, given that IEC 60870-5-103, IEC 60870-5-104, Modbus, and DNP are low-accuracy time synchronization methods, avoid their use for synchronization when better accuracy time protocols, such as IRIG-B and PTP, are active in the system. If IRIG-B or PTP is used to update the relay clock, the other protocols (such as SNTP) are not allowed to update, even if active.

See the **COMMANDS ⇒ SET DATE AND TIME** menu section of this manual to manually set the RTC.

The **REAL TIME CLOCK EVENTS** setting allows changes to the date and/or time to be captured in the event record. The event records the RTC time before the adjustment. A Date/Time Changed event is generated when:

- The real time clock changed from SNTP/PTP/IRIG-B and the time difference is more than one second
- The real time clock changed from the front panel or via Modbus register. The relay always generates this event regardless of the time difference.
- The Daylight Saving Time (DST) setting gets enabled and the current relay time is already in the DST zone
- The real time clock enters or leaves DST



To enable IRIG-B synchronization, the input **IRIG-B SIGNAL TYPE** must be set to DC Shift or Amplitude Modulated. IRIG-B synchronization can be disabled by making this setting None.

Clocks can be synchronized locally among several relays using the computer time. When using a time source, such as IRIG-B, the time is overwritten eventually by the time source. To synchronize clocks among UR devices:

1. In the EnerVista software, expand the main menu in the Online Window area and select the **Synchronize Devices** entry. The window opens. The software prompts to acknowledge any offline devices.
2. Click the **Synchronize Devices** button at the top of the window, and confirm the action at the prompt. The devices assume the time of the computer being used.

To configure and enable PTP and/or SNTP, or to set local time parameters (for example time zone, daylight savings), use the following sections.

### 5.3.7.2 Precision time protocol (1588)

SETTINGS ⇒ PRODUCT SETUP ⇒ REAL TIME CLOCK ⇒ PRECISION TIME PROTOCOL (1588)

<input checked="" type="checkbox"/> PRECISION TIME <input checked="" type="checkbox"/> PROTOCOL (1588)	↔	STRICT POWER PROFILE: Disabled Range: Enabled, Disabled
	↕	PTP DOMAIN NUMBER: 0 Range: 0 to 255
	↕	PTP VLAN PRIORITY: 4 Range: 0 to 7
	↕	PTP VLAN ID: 0 Range: 0 to 4095
	↑	<input checked="" type="checkbox"/> PTP PORT 1 <input checked="" type="checkbox"/> See below

SETTINGS ⇒ PRODUCT SETUP ⇒ REAL TIME CLOCK ⇒ PRECISION TIME PROTOCOL (1588) ⇒ PTP PORT 1(3)

<input checked="" type="checkbox"/> PTP PORT 1 <input checked="" type="checkbox"/>	↕	PORT 1 PTP FUNCTION: Disabled Range: Enabled, Disabled
	↕	PORT 1 PATH DELAY ADDER: 0 ns Range: 0 to 60000 ns in steps of 1
	↑	PORT 1 PATH DELAY ASYMMETRY: 0 ns Range: -1000 to +1000 ns in steps of 1



The G30 is provided with optional Precision Time Protocol capability. This feature is specified as the IEEE 1588 software option at the time of ordering. See the Order Codes section in chapter 2 for details.

The G30 supports the Precision Time Protocol (PTP) specified in IEEE Std 1588 2008 using the Power Profile (PP) specified in IEEE Std C37.238 2011. This enables the relay to synchronize to the international time standard over an Ethernet network that implements PP.

The relay can be configured to operate on some PTP networks that are not strictly PP. Time accuracy can be less than specified for a PP network. Tolerated deviations from strict PP include 1) missing declaration of PP compliance in the messages, 2) connection to a network device that does not support the PTP peer delay mechanism, 3) jitter substantially greater than 1  $\mu$ s in received event messages, and 4) certain non-compliant announce and sync message update rates.

The relay implements PTP according to IEEE Std 1588 2008 and the equivalent IEC 61588:2009(E), sometimes referred to as version 2 PTP. It does not support the previous version of the standard (version 1).

PTP is a protocol that allows multiple clocks in a network to synchronize with one another. It permits synchronization accuracies better than 1 ns, but this requires that each and every component in the network achieve very high levels of accuracy and a very high baud rate, faster than normally used for relay communications. When operating over a generic Ethernet network, time error can amount to 1 ms or more. PP is a profile of PTP which specifies a limited subset of PTP

suitable for use in power system protection, control, automation, and data communication applications, and thereby facilitates interoperability between different vendor's clocks and switches. PP specifies a worst-case delivered time error of less than 1  $\mu$ s over a 16-hop network.

In a PTP system and in a PP system, the clocks automatically organize themselves into a master-slave synchronization hierarchy with the "best" clock available making itself the "grandmaster" at the top of the hierarchy; all others make themselves "slaves" and track the grandmaster. Typically the grandmaster clock receives its time from GPS satellites or some other link to the international time standard. If the grandmaster fails, the next "best" clock available in the domain assumes the grandmaster role. When a clock on start-up discovers that it is "better" than the present grandmaster, it assumes the grandmaster role and the previous grandmaster reverts to slave. The G30 qualification mechanism accepts a potential master clock as a new grandmaster, when in a four-second interval it has received three announce messages from it, all better than the present grandmaster clock and better than any other announce in this interval.

Time messages issued by the grandmaster are delayed as they pass through the network both due to the finite speed of the signal in the interconnecting fiber or wire, and due to processing delays in the Ethernet switches. Each clock and switch implementing PP measures the propagation delay to each of its PP neighbors, and compensates for these delays in the time received. Each network device implementing PP measures the processing delay it introduces in each time message and compensates for this delay in the time it transmits. As a result, the time delivered to end-devices such as the UR are virtually identical to the grandmaster time. If one of the network devices in the hierarchy does not fully implement PP, the associated propagation delay and/or latency may not be compensated for, and the time received at the end-device can be in error by more than 100  $\mu$ s.

See the preceding Real Time Clock section for a description of when time values received via PTP are used to update the relay's real time clock.

The following settings are available for configuring the relay for PTP. The PTP menu displays only when the option was purchased.

## 5

**STRICT POWER PROFILE** — Power profile (IEEE Std C37.238 2011) requires that the relay only select a power profile compliant clock as a grandmaster, that the delivered time have worst-case error of  $\pm 1 \mu$ s, and that the peer delay mechanism be implemented. With the strict power profile setting enabled, the relay only selects as master the clocks displaying the IEEE\_C37\_238 identification codes. It uses a port only when the peer delay mechanism is operational. With the strict power profile setting disabled, the relay uses clocks without the power profile identification when no power profile clocks are present, and uses ports even if the peer delay mechanism is non-operational. This setting applies to all of the relay's PTP capable ports.

**PTP DOMAIN NUMBER** — Set this setting to the domain number of the grandmaster-capable clock(s) to be synchronized to. A network can support multiple time distribution domains, each distinguished with a unique domain number. More commonly, there is a single domain using the default domain number zero.

This setting applies to all of the relay's PTP capable ports.

**PTP VLAN PRIORITY** — This setting selects the value of the priority field in the 802.1Q VLAN tag in request messages issued by the relay's peer delay mechanism. In compliance with PP the default VLAN priority is 4, but it is recommended that it be set to 7 in accordance with PTP. Depending on the characteristics of the device to which the relay is linked directly, VLAN Priority can have no effect.

This setting applies to all of the relay's PTP capable ports.

**PTP VLAN ID** — This setting selects the value of the ID field in the 802.1Q VLAN tag in request messages issued by the relay's peer delay mechanism. It is provided in compliance with PP. As these messages have a destination address that indicates they are not to be bridged, their VLAN ID serves no function, and so can be left at its default value. Depending on the characteristics of the device to which the relay is linked directly, VLAN ID can have no effect. This setting applies to all of the relay's PTP capable ports.

**PORT 1 ... 3 FUNCTION** — While this port setting is selected to disabled, PTP is disabled on this port. The relay does not generate or listen to PTP messages on this port.

**PORT 1 ... 3 PATH DELAY ADDER** — The time delivered by PTP is advanced by the time value in this setting prior to the time being used to synchronize the relay's real time clock. This is to compensate to the extent practical for time delivery delays not compensated for in the network. In a fully compliant PP network, the peer delay and the processing delay mechanisms compensate for all the delays between the grandmaster and the relay. In such networks, make this setting zero.

In networks containing one or more switches and/or clocks that do not implement both of these mechanisms, not all delays are compensated, so the time of message arrival at the relay is later than the time indicated in the message. This setting can be used to approximately compensate for this delay. However, as the relay is not aware of network switching that dynamically changes the amount of uncompensated delay, there is no setting that always and completely corrects for uncompensated delay. A setting can be chosen that reduces the worst-case error to half of the range between minimum and maximum uncompensated delay, if these values are known.

**PORT 1 ... 3 PATH DELAY ASSYMMETRY** — This setting corresponds to “delayAsymmetry” in PTP, which is used by the peer delay mechanism to compensate for any difference in the propagation delay between the two directions of a link. Except in unusual cases, the two fibers are of essentially identical length and composition, so make this setting zero.

In unusual cases where the length of the link is different in different directions, set this setting to the number of nanoseconds the Ethernet propagation delay to the relay is longer than the mean of path propagation delays to and from the relay. For instance, if it is known say from the physical length of the fibers and the propagation speed in the fibers that the delay from the relay to the Ethernet switch it is connected to is 9000 ns and that the delay from the switch to the relay is 11000 ns, then the mean delay is 10000 ns, and the path delay asymmetry is 11000 - 10000 = +1000 ns.

### 5.3.7.3 SNTP protocol

SETTINGS ⇒ PRODUCT SETUP ⇒ ⚙ REAL TIME CLOCK ⇒ ⚙ SNTP PROTOCOL

■ SNTP PROTOCOL	↔	SNTP FUNCTION: Disabled	Range: Enabled, Disabled
	↕	SNTP SERVER1 IP ADDR: 127.0.0.1	Range: standard IP address format
	↕	SNTP SERVER2 IP ADDR: 127.0.0.1	Range: standard IP address format
	↕	SNTP SERVER1 UDP PORT: 123	Range: 0 to 65535 in steps of 1
	↑	SNTP SERVER2 UDP PORT: 123	Range: 0 to 65535 in steps of 1

The G30 supports the Simple Network Time Protocol specified in RFC-2030. With SNTP, the G30 can obtain clock time over an Ethernet network. The G30 acts as an SNTP client to receive time values from redundant SNTP/NTP servers, usually a dedicated product using a GPS receiver to provide an accurate time. One or two SNTP servers can be used; use of both servers for redundancy is recommended but not required.

To use SNTP, enable the function and set **SNTP SERVER1 IP ADDR** and/or **SNTP SERVER2 IP ADDR** to the SNTP/NTP server IP addresses. The G30 attempts to obtain time values from the SNTP SERVER1 SNTP/NTP server. If SERVER1 is not available/reachable, the G30 switches to the SNTP SERVER2 to get the time value and vice versa.

Since many time values are obtained and averaged, it generally takes three to four minutes until the G30 clock is closely synchronized with the SNTP/NTP server. It can take up to 20 minutes for the G30 to signal an SNTP self-test error if the server is offline, depending on the number and SNTP server modes. Broadcast mode timeout is 10 minutes and unicast timeout is 80 seconds (corresponds to three unicast request retries).

**SNTP FUNCTION** — Enables or disables the SNTP feature on the G30.

**SNTP SERVER1 IP ADDR** — The G30 uses the SERVER1 address to contact an SNTP/NTP server to obtain time values. When the **SNTP FUNCTION** setting is set to enabled or on startup if the setting is enabled, the G30 SNTP client requests SERVER1 for the time value. If the SERVER1 channel fails or is not reachable, the G30 switches to SERVER2 SNTP/NTP server.

If SERVER1 SNTP server is set to 127.0.0.1, the G30 considers the SERVER1 SNTP server to be unconfigured.

To use SERVER1 SNTP in broadcast mode, set the **SNTP SERVER1 IP ADDR** setting to "0.0.0.0" and **SNTP FUNCTION** to "Enabled." The G30 SNTP client then listens to SNTP messages sent to the "all ones" broadcast address for the subnet. The G30 waits up to 18 minutes (>1024 seconds) without receiving an SNTP broadcast message before switching to the alternate channel.

**SNTP SERVER2 IP ADDR** — The G30 uses this address to contact an SNTP/NTP server if SERVER1 channel fails or is not reachable. If SERVER2 SNTP server is set to 127.0.0.1, the G30 considers the SERVER2 SNTP server to be unconfigured.

To use SERVER2 SNTP in broadcast mode, set the **SNTP SERVER2 IP ADDR** setting to "0.0.0.0" and **SNTP FUNCTION** to "Enabled." The G30 SNTP client then listens to SNTP messages sent to the "all ones" broadcast address for the subnet. The G30 waits up to 18 minutes (>1024 seconds) without receiving an SNTP broadcast message before switching to the alternate channel.

**SNTP SERVER1 UDP PORT** — This setting is 123 for normal SNTP operation. If SERVER1 SNTP is not required, close the port by changing this setting to zero.

**SNTP SERVER2 UDP PORT** — This setting is 123 for normal SNTP operation. If SERVER2 SNTP is not required, close the port by changing this setting to zero.



Do not set more than one protocol to the same TCP/UDP port number, as this results in unreliable operation of those protocols.

If **SERVER1 IP ADDR** and **UDP PORT** settings match the **SERVER2 IP ADDR** and **UDP PORT** settings, the G30 considers only the SERVER1 SNTP server as being configured and an SNTP Failure error message generates. The failure message also displays when both servers are unavailable.

### 5.3.7.4 Local time

SETTINGS ⇒ PRODUCT SETUP ⇒ REAL TIME CLOCK ⇒ LOCAL TIME

<input checked="" type="checkbox"/> LOCAL TIME	↔	LOCAL TIME OFFSET FROM UTC: 0.0 hr	Range: -24.0 to 24.0 hr in steps of 0.5
	⇕	DAYLIGHT SAVINGS TIME: Disabled	Range: Disabled, Enabled
	⇕	DST START MONTH: January	Range: January to December (all months)
	⇕	DST START DAY: Sunday	Range: Sunday to Saturday (all days of the week)
	⇕	DST START DAY INSTANCE: First	Range: First, Second, Third, Fourth, Last
	⇕	DST START HOUR: 2:00	Range: 0:00 to 23:00 in steps of one hour
	⇕	DST STOP MONTH: January	Range: January to December (all months)
	⇕	DST STOP DAY: Sunday	Range: Sunday to Saturday (all days of the week)
	⇕	DST STOP DAY INSTANCE: First	Range: First, Second, Third, Fourth, Last
	↑	DST STOP HOUR: 2:00	Range: 0:00 to 23:00 in steps of one hour

The G30 maintains two times: local time and Universal Coordinated Time (UTC). Local time can be provided by IRIG-B signals. UTC time is provided by SNTP servers.

The real-time clock (RTC) and time stamps reported in historical records and communication protocols can be incorrect if the Local Time settings are not configured properly.

See the IRIG-B section in the Installation chapter for guidance on these settings when using an IRIG-B source that sets the IRIG-B control bits according to IEEE Std 1344-1995.

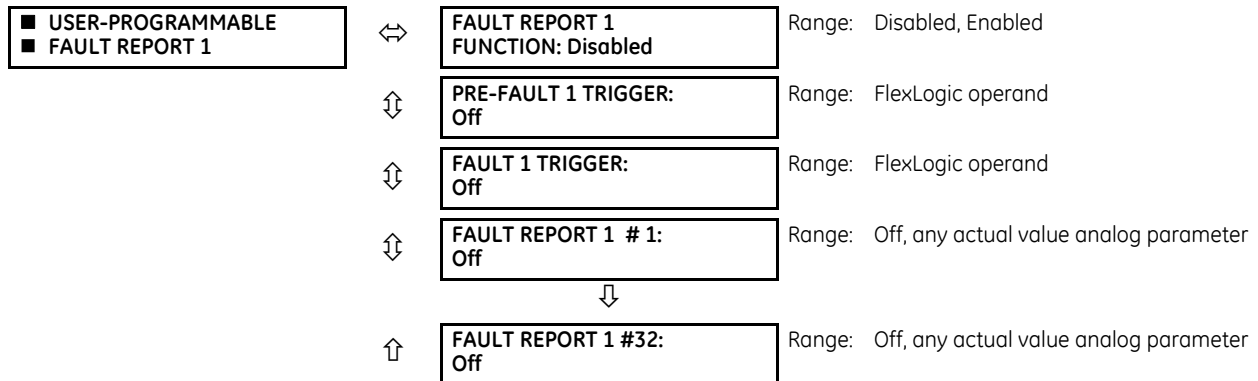
**LOCAL TIME OFFSET FROM UTC** — Used to specify the local time zone offset from UTC (Greenwich Mean Time) in hours. Time zones in the eastern hemisphere have positive values; time zones in the western hemisphere have negative values. A value of zero causes the relay to use UTC for local time. This setting has two uses. When the system RTC is synchronized with a communications protocol providing only local time or it is free-running, the offset setting is used to calculate UTC from the

local time these provide. When the RTC is synchronized with a communications protocol providing only UTC (such as PTP or SNTP), the time offset setting is used to determine local time from the UTC provided. PTP ALTERNATE\_TIME\_OFFSET\_INDICATOR TLVs are not used to calculate local time.

**DAYLIGHT SAVINGS TIME** and **DST** — Can be used to allow the relay to follow the DST rules of the local time zone. Note that when IRIG-B time synchronization is active, the local time in the IRIG-B signal contains any daylight savings time offset and so the DST settings are ignored.

### 5.3.8 User-programmable fault report

SETTINGS ⇒ PRODUCT SETUP ⇒ USER-PROGRAMMABLE FAULT REPORTS ⇒ USER-PROGRAMMABLE FAULT REPORT 1(2)



When enabled, this function monitors the pre-fault trigger. The pre-fault data are stored in the memory for prospective creation of the fault report on the rising edge of the pre-fault trigger. The element waits for the fault trigger as long as the pre-fault trigger is asserted, but not shorter than 1 second. When the fault trigger occurs, the fault data is stored and the complete report is created. If the fault trigger does not occur within 1 second after the pre-fault trigger drops out, the element resets and no record is created.

The user programmable record contains the following information: the user-programmed relay name, detailed firmware revision (x.xx, for example) and relay model (G30), the date and time of trigger, the name of pre-fault trigger (a specific FlexLogic operand), the name of fault trigger (a specific FlexLogic operand), the active setting group at pre-fault trigger, the active setting group at fault trigger, pre-fault values of all programmed analog channels (one cycle before pre-fault trigger), and fault values of all programmed analog channels (at the fault trigger).

Each fault report is stored as a file to a maximum capacity of ten files. An eleventh trigger overwrites the oldest file. The EnerVista software is required to view all captured data. A FAULT RPT TRIG event is automatically created when the report is triggered.

The relay includes two user-programmable fault reports to enable capture of two types of trips (for example, trip from thermal protection with the report configured to include temperatures, and short-circuit trip with the report configured to include voltages and currents). Both reports feed the same report file queue.

The last record is available as individual data items via communications protocols.

**PRE-FAULT 1 TRIGGER** — Specifies the FlexLogic operand to capture the pre-fault data. The rising edge of this operand stores one cycle-old data for subsequent reporting. The element waits for the fault trigger to actually create a record as long as the operand selected as **PRE-FAULT 1 TRIGGER** is "On." If the operand remains "Off" for 1 second, the element resets and no record is created.

**FAULT 1 TRIGGER** — Specifies the FlexLogic operand to capture the fault data. The rising edge of this operand stores the data as fault data and results in a new report. The trigger (not the pre-fault trigger) controls the date and time of the report.

**FAULT REPORT 1 #1** to **FAULT REPORT 1 #32** — These settings specify an actual value such as voltage or current magnitude, true RMS, phase angle, frequency, temperature, and so on, to be stored when the report is created. Up to 32 channels can be configured. Two reports are configurable to cope with variety of trip conditions and items of interest.

### 5.3.9 Oscillography

#### 5.3.9.1 Menu

SETTINGS ⇒ PRODUCT SETUP ⇒ OSCILLOGRAPHY

<input checked="" type="checkbox"/> OSCILLOGRAPHY <input checked="" type="checkbox"/>	↔	NUMBER OF RECORDS: 5	Range: 1 to 64 in steps of 1
	⇅	TRIGGER MODE: Automatic Overwrite	Range: Automatic Overwrite, Protected
	⇅	TRIGGER POSITION: 50%	Range: 0 to 100% in steps of 1
	⇅	TRIGGER SOURCE: Off	Range: FlexLogic operand
	⇅	AC INPUT WAVEFORMS: 16 samples/cycle	Range: Off, 8, 16, 32, 64 samples/cycle
	⇅	<input checked="" type="checkbox"/> DIGITAL CHANNELS <input checked="" type="checkbox"/>	See below
	↑	<input checked="" type="checkbox"/> ANALOG CHANNELS <input checked="" type="checkbox"/>	See below

Oscillography records contain waveforms captured at the sampling rate as well as other relay data at the point of trigger. Oscillography records are triggered by a programmable FlexLogic operand. Multiple oscillography records can be captured simultaneously.

To retrieve an Oscillography record from a relay:

1. If not yet set up for oscillography, configure settings under **Settings > Product Setup > Oscillography** in the EnerVista software.
2. Access **Actual Values > Records > Oscillography** in the EnerVista software.
3. In the window that opens, select the record number. The highest number is the most recent record (Newest Record Number).
4. Click the **Read** button to get the waveform. When available, waveforms are displayed graphically, and otherwise error messages display.
5. In the waveform window that opens, you can save the file, for example with the CFG extension.

When EnerVista UR Setup creates a new settings file, a Smart defaults feature automatically enters a basic oscillography configuration. The basic configuration changes the factory default values to make the number of samples per cycle 32, adds a selection of digital and analog channels that are often of interest, and adds a FlexLogic equation to trigger oscillography. Review and update this basic configuration as required for the application at hand.

The **NUMBER OF RECORDS** is selectable, but the number of cycles captured in a single record varies considerably based on other factors, such as sample rate and the number of operational modules. There is a fixed amount of data storage for oscillography; the more data captured, the less the number of cycles captured per record. See the **ACTUAL VALUES ⇒ RECORDS ⇒ OSCILLOGRAPHY** menu to view the number of cycles captured per record. The following table provides sample configurations with corresponding cycles/record. The minimum number of oscillographic records is three.

Table 5-13: Oscillography cycles/record example


Records	CT/VTs	Sample rate	Digital channels	Analog channels	Cycles per record
3	1	32	32	16	2399
3	1	64	32	16	1450
16	1	32	32	16	666
16	1	64	32	16	402
32	1	32	32	16	352
32	1	64	32	16	213
3	2	32	32	16	1516
3	2	64	32	16	851
16	2	32	32	16	421

**TRIGGER MODE** — A new record automatically overwrites an older record when **TRIGGER MODE** is set to “Automatic Overwrite.”

**TRIGGER POSITION** — Set this to a percentage of the total buffer size (for example, 10%, 50%, 75%, and so on). A trigger position of 25% consists of 25% pre- and 75% post-trigger data.

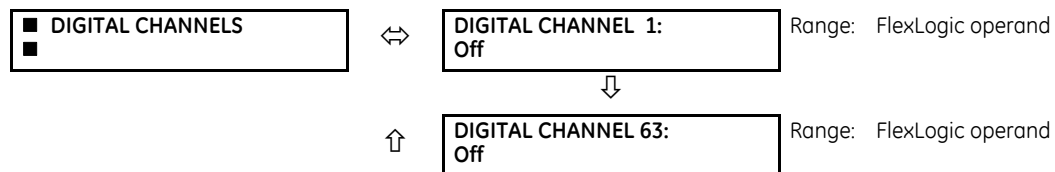
**TRIGGER SOURCE** — Always captured in oscillography and can be any FlexLogic parameter (element state, contact input, virtual output, and so on). The relay sampling rate is 64 samples per cycle.

**AC INPUT WAVEFORMS** — Determines the sampling rate at which AC input signals (that is, current and voltage) are stored. Reducing the sampling rate allows longer records to be stored. This setting has no effect on the internal sampling rate of the relay, which is always 64 samples per cycle. That is, it has no effect on the fundamental calculations of the device.

 When changes are made to the oscillography settings, all existing oscillography records are cleared.

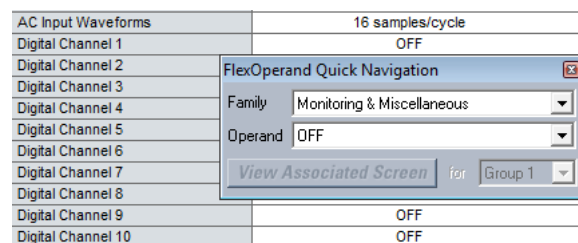
### 5.3.9.2 Digital channels

SETTINGS ⇒ PRODUCT SETUP ⇒ ↓ OSCILLOGRAPHY ⇒ ↓ DIGITAL CHANNELS



**DIGITAL 1(63) CHANNEL** — This setting selects the FlexLogic operand state recorded in an oscillography trace. The length of each oscillography trace depends in part on the number of parameters selected here. Parameters set to “Off” are ignored. To populate quickly the rows in the Offline Window, use Ctrl C/V to copy/paste, or click then double-click a row to display a quick selection window.

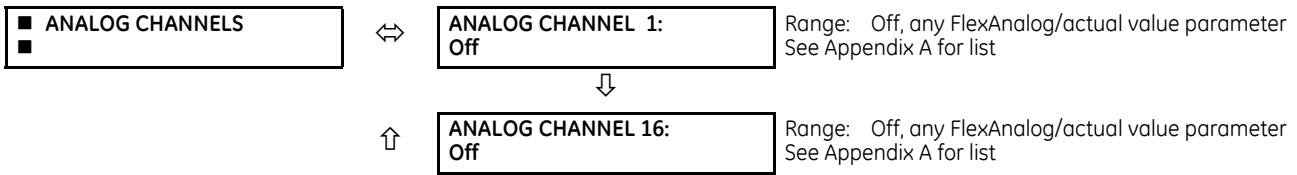
Figure 5-49: Quick selection window





### 5.3.9.3 Analog channels

SETTINGS ⇒ PRODUCT SETUP ⇒ OSCILLOGRAPHY ⇒ ANALOG CHANNELS



These settings select the metering actual value recorded in an oscillography trace. The length of each oscillography trace depends in part on the number of parameters selected here. Parameters set to “Off” are ignored. The parameters available in a given relay depend on

- the type of relay,
- the type and number of CT/VT hardware modules installed, and
- the type and number of analog input hardware modules installed

A list of all possible analog metering actual value parameters is presented in Appendix A: FlexAnalog Parameters. The parameter index number shown in any of the tables is used to expedite the selection of the parameter on the relay display. It can be time-consuming to scan through the list of parameters via the relay keypad and display — entering this number via the relay keypad causes the corresponding parameter to display.

All eight CT/VT module channels are stored in the oscillography file. The CT/VT module channels are named as follows:

*<slot\_letter><terminal\_number>—<I or V><phase A, B, or C, or 4th input>*

The fourth current input in a bank is called IG, and the fourth voltage input in a bank is called VX. For example, F2-IB designates the IB signal on terminal 2 of the CT/VT module in slot F.

If there are no CT/VT modules and analog input modules, no analog traces appear in the file; only the digital traces appear.

The source harmonic indices appear as oscillography analog channels numbered from 0 to 23. These correspond directly to the 2nd to 25th harmonics in the relay as follows:

Analog channel 0 ↔ 2nd harmonic

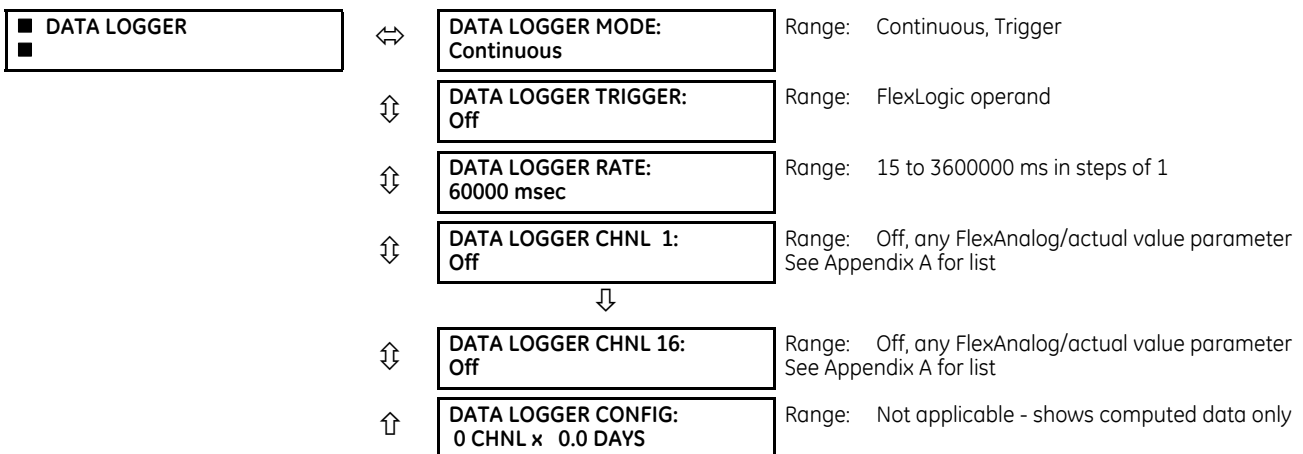
Analog channel 1 ↔ 3rd harmonic

...

Analog channel 23 ↔ 25th harmonic

### 5.3.10 Data logger

SETTINGS ⇒ PRODUCT SETUP ⇒ DATA LOGGER





The data logger samples and records up to 16 analog parameters at a user-defined sampling rate. This recorded data can be downloaded to EnerVista UR Setup and displayed with parameters on the vertical axis and time on the horizontal axis. All data is stored in non-volatile memory, so the information is retained when power to the relay is lost.

For a fixed sampling rate, the data logger can be configured with a few channels over a long period or a larger number of channels for a shorter period. The relay automatically partitions the available memory between the channels in use. The following table outlines examples of storage capacities for a system frequency of 60 Hz.

**Table 5-14: Data logger storage capacity example**

Sampling rate	Channels	Days	Storage capacity
15 ms	1	0.1	482 s
	8	0.1	60 s
	9	0.1	54 s
	16	0.1	30 s
1000 ms	1	0.3	32729 s
	8	0.1	4091 s
	9	0.1	3637 s
	16	0.1	2046 s
60000 ms	1	22.7	1963710 s
	8	2.8	245460 s
	9	2.5	218190 s
	16	1.4	127230 s
3600000 ms	1	1362.1	117822600 s
	8	170.2	14727600 s
	9	151.3	13091400 s



Changing any setting affecting data logger operation clears data in the log.

NOTE

**DATA LOGGER MODE** — This setting configures the mode in which the data logger operates. When set to “Continuous,” the data logger actively records any configured channels at the rate as defined by the **DATA LOGGER RATE**. The data logger is idle in this mode when no channels are configured. When set to “Trigger,” the data logger records any configured channels at the instance of the rising edge of the **DATA LOGGER TRIGGER** source FlexLogic operand. The data logger ignores all subsequent triggers and continues to record data until the active record is full. Once the data logger is full, a CLEAR DATA LOGGER command is required to clear the data logger record before a new record can be started. Performing the CLEAR DATA LOGGER command also stops the current record and resets the data logger to be ready for the next trigger.

**DATA LOGGER TRIGGER** — This setting selects the signal used to trigger the start of a new data logger record. Any FlexLogic operand can be used as the trigger source. This setting only applies when the mode is set to “Trigger.”

**DATA LOGGER RATE** — This setting selects the time interval at which the actual value data is recorded.

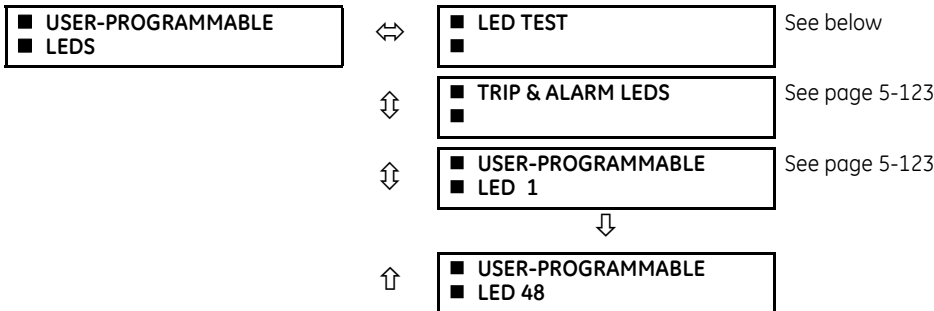
**DATA LOGGER CHNL 1(16)** — This setting selects the metering actual value that is to be recorded in Channel 1(16) of the data log. The parameters available in a given relay are dependent on: the type of relay, the type and number of CT/VT hardware modules installed, and the type and number of Analog Input hardware modules installed. Upon startup, the relay automatically prepares the parameter list. A list of all possible analog metering actual value parameters is shown in Appendix A: FlexAnalog Parameters. The parameter index number shown in any of the tables is used to expedite the selection of the parameter on the relay display. It can be time-consuming to scan through the list of parameters via the relay keypad/display—entering this number via the relay keypad causes the corresponding parameter to display.

**DATA LOGGER CONFIG** — This display presents the total amount of time that the Data Logger can record the channels not selected to “Off” without overwriting old data.

### 5.3.11 User-programmable LEDs

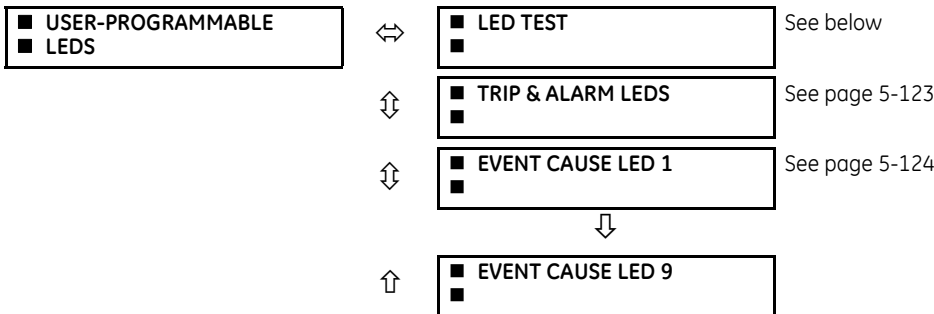
#### 5.3.11.1 Menu - Enhanced and basic front panels

SETTINGS ⇒ PRODUCT SETUP ⇒ USER-PROGRAMMABLE LEDES



#### 5.3.11.2 Menu - Graphical front panel

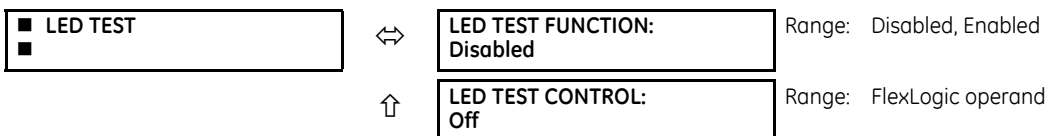
SETTINGS ⇒ PRODUCT SETUP ⇒ USER-PROGRAMMABLE LEDES



The LEDs can be customized to illuminate when a selected FlexLogic operand is in the logic 1 state. The trip and alarm LEDs can also be customized in a similar manner. To ensure correct functionality of all LEDs, an LED test feature is also provided.

#### 5.3.11.3 LED test

SETTINGS ⇒ PRODUCT SETUP ⇒ USER-PROGRAMMABLE LEDES ⇒ LED TEST



When enabled, the LED test can be initiated from any digital input or user-programmable condition, such as a user-programmable pushbutton. The control operand is configured under the LED TEST CONTROL setting. The test covers all LEDs, including the LEDs of the optional user-programmable pushbuttons.

For the enhanced and basic front panels, the test consists of the following three stages:

1. All 62 LEDs on the relay are illuminated. This is a quick test to verify if any of the LEDs is “burned.” This stage lasts as long as the control input is on, up to a maximum of one minute. After one minute, the test ends.
2. All the LEDs are turned off, and then one LED at a time turns on for one second, then back off. The test routine starts at the top left panel, moving from the top to bottom of each LED column. This test checks for hardware failures that lead to more than one LED being turned on from a single logic point. This stage can be interrupted at any time.
3. All the LEDs are turned on. One LED at a time turns off for one second, then back on. The test routine starts at the top left panel moving from top to bottom of each column of the LEDs. This test checks for hardware failures that lead to more than one LED being turned off from a single logic point. This stage can be interrupted at any time.

For the graphical front panel, the test consists of the following stages:

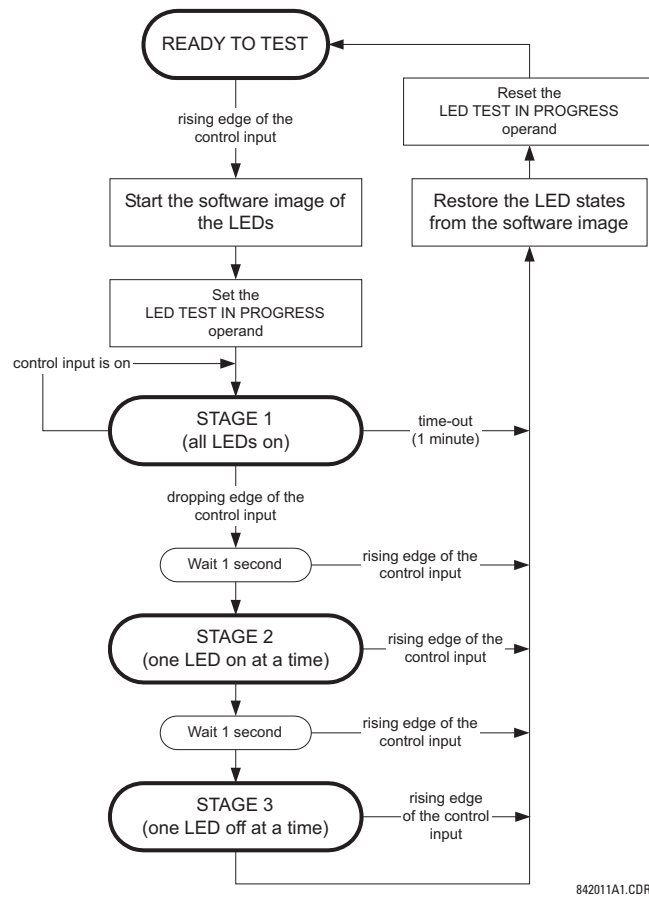
1. All 22 LEDs on the relay are illuminated. This is a quick test to verify if any of the LEDs is "burned." This stage lasts as long as the control input is on, up to a maximum of one minute. After one minute, the test ends.
2. All the LEDs are turned off, and then one LED at a time turns on with the orange color for one second, then back off. The test routine starts at the top left panel, moving from the top to bottom for all 14 LEDs. Then the eight pushbutton LEDs are tested in the same manner. This test checks for hardware failures that lead to more than one LED being turned on from a single logic point. This stage can be interrupted at any time.
3. All the LEDs are turned on with the orange color. One LED at a time turns off for one second, then back on. The test routine starts at the top left panel moving from top to bottom for all 14 LEDs. Then the eight pushbutton LEDs are tested in the same manner. This test checks for hardware failures that lead to more than one LED being turned off from a single logic point. This stage can be interrupted at any time.
4. Additionally, stages 2 and 3 are repeated twice for the five device status LEDs and nine event cause LEDs, one time with green color on and the other with red color on.

When testing is in progress, the LEDs are controlled by the test sequence, rather than the protection, control, and monitoring features. However, the LED control mechanism accepts all the changes to LED states generated by the relay and stores the actual LED states (on or off) in memory. When the test completes, the LEDs reflect the actual state resulting from relay response during testing. The reset pushbutton does not clear any targets when the LED Test is in progress.

A dedicated FlexLogic operand, **LED TEST IN PROGRESS**, is set for the duration of the test. When the test sequence is initiated, the LED TEST INITIATED event is stored in the event recorder.

The entire test procedure is user-controlled. In particular, stage 1 can last as long as necessary, and stages 2 and 3 can be interrupted. The test responds to the position and rising edges of the control input defined by the **LED TEST CONTROL** setting. The control pulses must last at least 250 ms to take effect. The following diagram explains how the test is executed.

Figure 5-50: LED test sequence



**Application example 1**

Assume one needs to check if any of the LEDs is “burned” through user-programmable pushbutton 1. Apply the following settings.

Configure user-programmable pushbutton 1 by making the following entries in the **SETTINGS ⇒ PRODUCT SETUP ⇒ USER-PROGRAMMABLE PUSHBUTTONS ⇒ USER PUSHBUTTON 1** menu. (The option does not display when not purchased.)

- PUSHBUTTON 1 FUNCTION:** “Self-reset”
- PUSHBTN 1 DROP-OUT TIME:** “0.10 s”

Configure the LED test to recognize user-programmable pushbutton 1 by making the following entries in the **SETTINGS ⇒ PRODUCT SETUP ⇒ USER-PROGRAMMABLE LEDs ⇒ LED TEST** menu:

- LED TEST FUNCTION:** “Enabled”
- LED TEST CONTROL:** “PUSHBUTTON 1 ON”

The test is initiated when the user-programmable pushbutton 1 is pressed. Keep the pushbutton pressed for as long as the LEDs are being visually inspected. When finished, release the pushbutton. The relay then automatically starts stage 2. At this point, test can be cancelled by pressing the pushbutton.

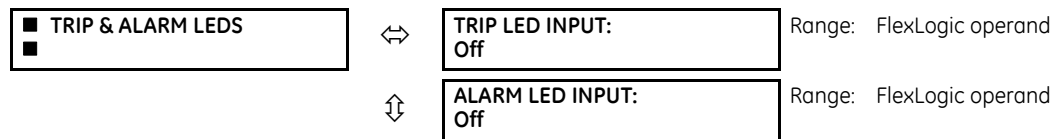
**Application example 2**

Assume one needs to check if any LEDs are “burned” as well as exercise one LED at a time to check for other failures. This is to be performed via user-programmable pushbutton 1.

After applying the settings in application example 1, hold down the pushbutton as long as necessary to test all LEDs. When finished, release the pushbutton so that the relay then automatically starts stage 2. When stage 2 is completed, stage 3 starts automatically. The test can be cancelled at any time by pressing the pushbutton.

### 5.3.11.4 Trip and alarm LEDs

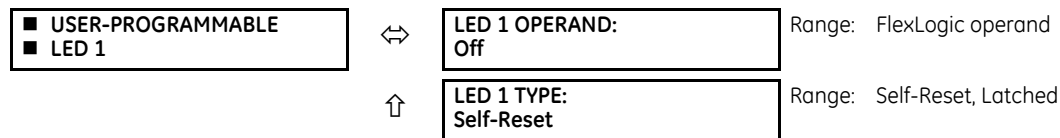
SETTINGS ⇒ PRODUCT SETUP ⇒ ⇅ USER-PROGRAMMABLE LEDs ⇒ ⇅ TRIP & ALARMS LEDs



The trip and alarm LEDs are in the first LED column (enhanced and graphical front panels) and on LED panel 1 (basic front panel). Each LED can be programmed to turn on when the selected FlexLogic operand is in the logic 1 state.

### 5.3.11.5 User-programmable LED 1(48)

SETTINGS ⇒ PRODUCT SETUP ⇒ ⇅ USER-PROGRAMMABLE LEDs ⇒ ⇅ USER-PROGRAMMABLE LED 1(48)



For the enhanced and basic front panels, there are 48 amber LEDs across the relay LED panels. Each of these indicators can be programmed to illuminate when the selected FlexLogic operand is in the logic 1 state.

For the basic front panel, the LEDs are located as follows:

- LED Panel 2 — User-programmable LEDs 1 through 24
- LED Panel 3 — User programmable LEDs 25 through 48

For the enhanced front panel, the LEDs are located as follows:

- LED column 2 — User-programmable LEDs 1 through 12
- LED column 3 — User-programmable LEDs 13 through 24
- LED column 4 — User-programmable LEDs 25 through 36
- LED column 5 — User-programmable LEDs 37 through 48

See the LED Indicators section in chapter 4 for information on the location of these indexed LEDs.

The user-programmable LED settings select the FlexLogic operands that control the LEDs. If the **LED 1 TYPE** setting is “Self-Reset” (the default setting), the LED illumination tracks the state of the selected LED operand. If the **LED 1 TYPE** setting is “Latched,” the LED, once lit, remains so until reset by the front panel **RESET** button, from a remote device via a communications channel, or from any programmed operand, even if the LED operand state de-asserts.

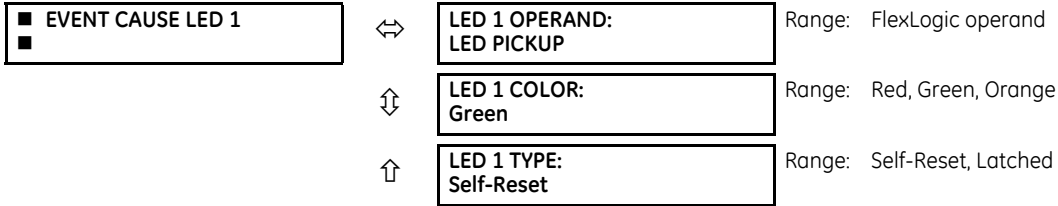
**Table 5-15: Recommended settings for user-programmable LEDs**

Setting	Parameter	Setting	Parameter
LED 1 operand	SETTING GROUP ACT 1	LED 13 operand	Off
LED 2 operand	SETTING GROUP ACT 2	LED 14 operand	Off
LED 3 operand	SETTING GROUP ACT 3	LED 15 operand	Off
LED 4 operand	SETTING GROUP ACT 4	LED 16 operand	Off
LED 5 operand	SETTING GROUP ACT 5	LED 17 operand	SYNC 1 SYNC OP
LED 6 operand	SETTING GROUP ACT 6	LED 18 operand	SYNC 2 SYNC OP
LED 7 operand	Off	LED 19 operand	Off
LED 8 operand	Off	LED 20 operand	Off
LED 9 operand	Off	LED 21 operand	Off
LED 10 operand	Off	LED 22 operand	Off
LED 11 operand	Off	LED 23 operand	Off
LED 12 operand	Off	LED 24 operand	Off

See the figure in the Setting Groups section of the Control Elements section later in this chapter for an example of group activation.

### 5.3.11.6 Event cause LED 1(9)

SETTINGS ⇒ PRODUCT SETUP ⇒ USER-PROGRAMMABLE LEADS ⇒ EVENT CAUSE LED 1(9)



For the graphical front panel, the event cause LED settings select the FlexLogic operands that control the LEDs.

**LED 1 TYPE** — If set to "Self-Reset," the LED illumination tracks the state of the selected LED operand. If set to "Latched," the LED, once lit, remains so even the LED operand state already de-asserts, until reset by the front panel **RESET** button, from a remote device via a communications channel, or from any programmed operand.

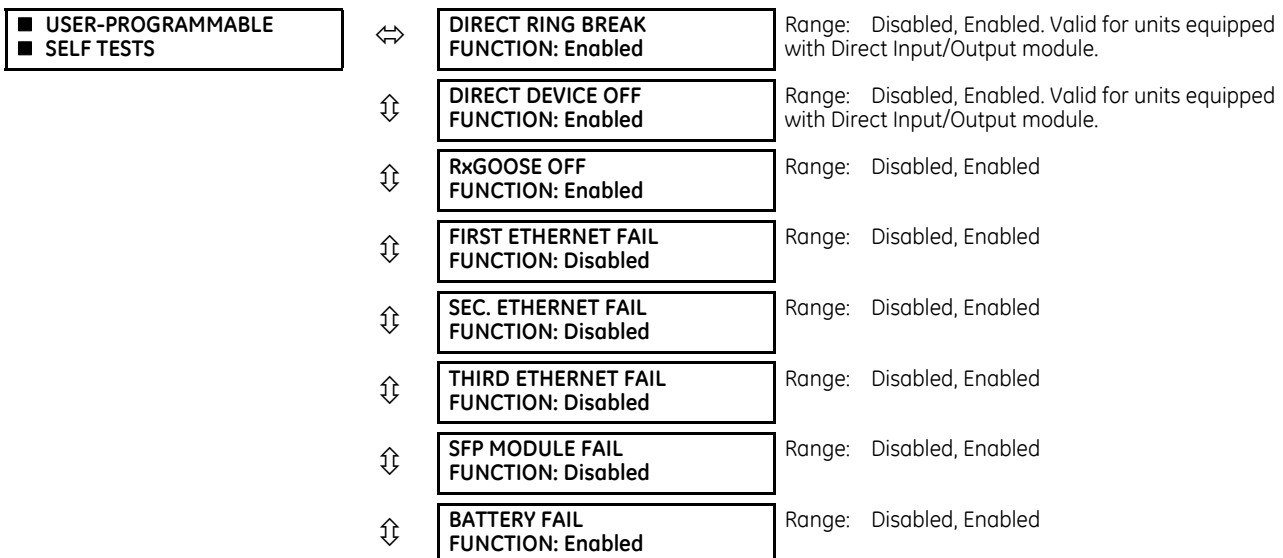
The table outlines default input operand and output operands for each event cause LED.

Table 5-16: Default input and output operand for event cause LEDs

LED	Default input operand	Output operand	Default color
Event Cause LED 1	LED PICKUP	EVENT CAUSE LED 1	Green
Event Cause LED 2	LED VOLTAGE	EVENT CAUSE LED 2	Orange
Event Cause LED 3	LED CURRENT	EVENT CAUSE LED 3	Orange
Event Cause LED 4	LED FREQUENCY	EVENT CAUSE LED 4	Orange
Event Cause LED 5	LED OTHER	EVENT CAUSE LED 5	Orange
Event Cause LED 6	LED PHASE A	EVENT CAUSE LED 6	Orange
Event Cause LED 7	LED PHASE B	EVENT CAUSE LED 7	Orange
Event Cause LED 8	LED PHASE C	EVENT CAUSE LED 8	Orange
Event Cause LED 9	LED NEUTRAL/GROUND	EVENT CAUSE LED 9	Orange

### 5.3.12 User-programmable self-tests

SETTINGS ⇒ PRODUCT SETUP ⇒ USER-PROGRAMMABLE SELF TESTS



↕	SNTP FAIL FUNCTION: Enabled	Range: Disabled, Enabled
↕	IRIG-B FAIL FUNCTION: Enabled	Range: Disabled, Enabled
↑	PTP FAIL FUNCTION: Enabled	Range: Disabled, Enabled

All major self-test alarms are reported automatically with their corresponding FlexLogic operands, events, and targets.

This settings menu allows enabling and disabling of most minor self-test alarms.

When in the Disabled mode, minor alarms do not assert a FlexLogic operand, write to the event recorder, or display target messages. Moreover, they do not trigger the ANY MINOR ALARM or ANY SELF-TEST messages. When in Enabled mode, minor alarms continue to function along with other major and minor alarms. See the Relay Self-tests section in chapter 7 for information on major and minor self-test alarms.

When using the graphical front panel and setting annunciator alarms, the function needs to be enabled here too, else the alarm is not triggered.

### 5.3.13 Control pushbuttons

SETTINGS ⇒ PRODUCT SETUP ⇒ ↕ CONTROL PUSHBUTTONS ⇒ CONTROL PUSHBUTTON 1(7)

<ul style="list-style-type: none"> <li>■ CONTROL</li> <li>■ PUSHBUTTON 1</li> </ul>	↔	CONTROL PUSHBUTTON 1 ID CTRL PB 1	Range: up to 20 alphanumeric characters
	↕	CONTROL PUSHBUTTON 1 FUNCTION: Disabled	Range: Disabled, Enabled
	↑	CONTROL PUSHBUTTON 1 EVENTS: Disabled	Range: Disabled, Enabled

This feature is supported with enhanced and basic front panels.

There are three standard control pushbuttons, labelled USER 1, USER 2, and USER 3, on the basic and enhanced front panels. These are user-programmable and can be used for various applications such as performing an LED test, switching setting groups, and invoking and scrolling through user-programmable displays.

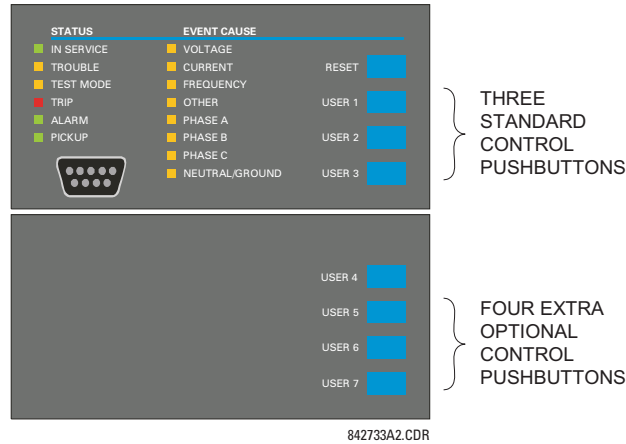
The location of the control pushbuttons are shown in the following figures.

Figure 5-51: Control pushbuttons (enhanced front panel)



An additional four control pushbuttons are included on the basic front panel when the G30 is ordered with the 12 user-programmable pushbutton option.

Figure 5-52: Control pushbuttons (basic front panel)

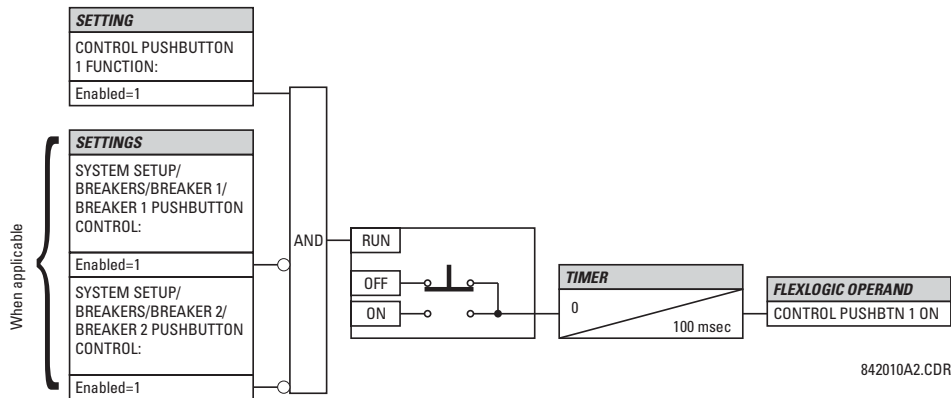


Control pushbuttons are not typically used for critical operations and are not protected by the control password. However, by supervising their output operands, the user can dynamically enable or disable control pushbuttons for security reasons. Each control pushbutton asserts its own FlexLogic operand. Each operand need to be configured appropriately to perform the required function. Each operand remains asserted as long as the pushbutton is pressed and resets when the pushbutton is released. A dropout delay of 100 ms is incorporated to ensure fast pushbutton manipulation is recognized by various features that can use control pushbuttons as inputs.

An event is logged in the event record (as per user setting) when a control pushbutton is pressed. No event is logged when the pushbutton is released. The front panel keys (including control keys) cannot be operated simultaneously—a given key must be released before the next one can be pressed.

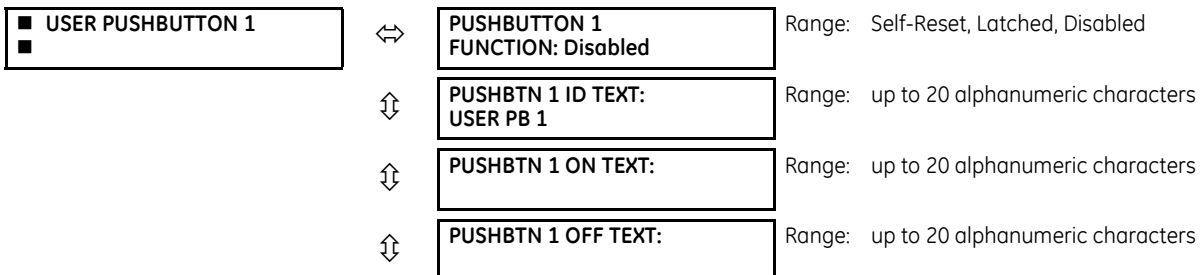
5

Figure 5-53: Control pushbutton logic



### 5.3.14 User-programmable pushbuttons

SETTINGS ⇒ PRODUCT SETUP ⇒ USER-PROGRAMMABLE PUSHBUTTONS ⇒ USER PUSHBUTTON 1(16)





⇅	PUSHBTN 1 HOLD: 0.0 s	Range: 0.0 to 10.0 s in steps of 0.1
⇅	PUSHBTN 1 SET: Off	Range: FlexLogic operand
⇅	PUSHBTN 1 RESET: Off	Range: FlexLogic operand
⇅	PUSHBTN 1 AUTORST: Disabled	Range: Disabled, Enabled
⇅	PUSHBTN 1 AUTORST DELAY: 1.0 s	Range: 0.2 to 600.0 s in steps of 0.1
⇅	PUSHBTN 1 REMOTE: Off	Range: FlexLogic operand
⇅	PUSHBTN 1 LOCAL: Off	Range: FlexLogic operand
⇅	PUSHBTN 1 DROP-OUT TIME: 0.00 s	Range: 0 to 60.00 s in steps of 0.05
⇅	PUSHBTN 1 LED CTL: Off	Range: FlexLogic operand
⇅	PUSHBTN 1 MESSAGE: Disabled	Range: Disabled, Normal, High Priority
↑	PUSHBUTTON 1 EVENTS: Disabled	Range: Disabled, Enabled



The G30 is provided with this optional feature, specified as an option at the time of ordering. Using the order code for your device, see the order codes in chapter 2 for details.

User-programmable pushbuttons provide an easy and error-free method of entering digital state (on, off) information. The number depends on the front panel ordered.

- Enhanced horizontal front panel — 16 user-programmable pushbuttons
- Enhanced vertical front panel — 6 user-programmable pushbuttons
- Basic horizontal front panel — 12 user-programmable pushbuttons
- Graphical front panel — 16 user-programmable pushbuttons (eight physical pushbuttons, eight graphical interface pushbuttons)



User-programmable pushbuttons require a front panel with that option. If the front panel was ordered separately, update the EnerVista software under **Maintenance > Change Front Panel**.

The digital state can be entered locally (by directly pressing the front panel pushbutton or optional graphical front panel interface) or remotely (via FlexLogic operands) into FlexLogic equations, protection elements, and control elements. Typical applications include breaker control, autorecloser blocking, and setting groups changes. For example, set pushbuttons 1 to 5 to select settings groups 1 to 5, or set pushbutton 1 to clear event records. The user-programmable pushbuttons are under the control level of password protection.

### Example

To clear event records using pushbutton 1, set **Settings > Product Setup > Clear Relay Records > Clear Event Records** to FlexLogic operand **PUSHBUTTON 1 ON**. Then program the pushbutton by setting **Settings > Product Setup > User-Programmable Pushbuttons > Pushbutton 1 Function** to "Self-reset." For a graphical front panel, to use a side pushbutton 9 to 16 to clear the event records, it also needs to be programmed in a single-line diagram.

The figures show user-configurable pushbuttons for the front panels.

Figure 5-54: User-programmable pushbuttons (enhanced front panel)

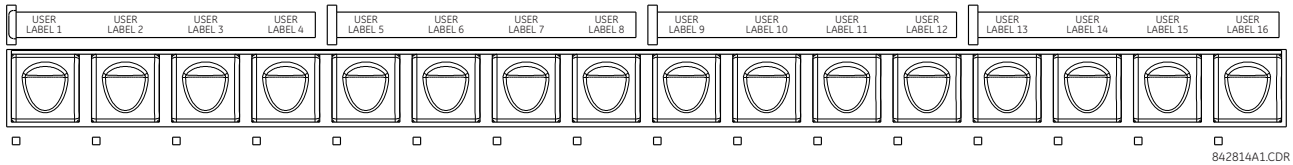


Figure 5-55: User-programmable pushbuttons (basic front panel)

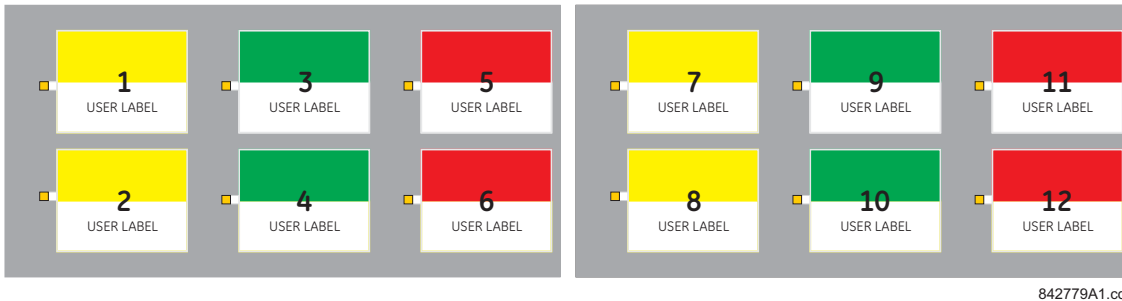
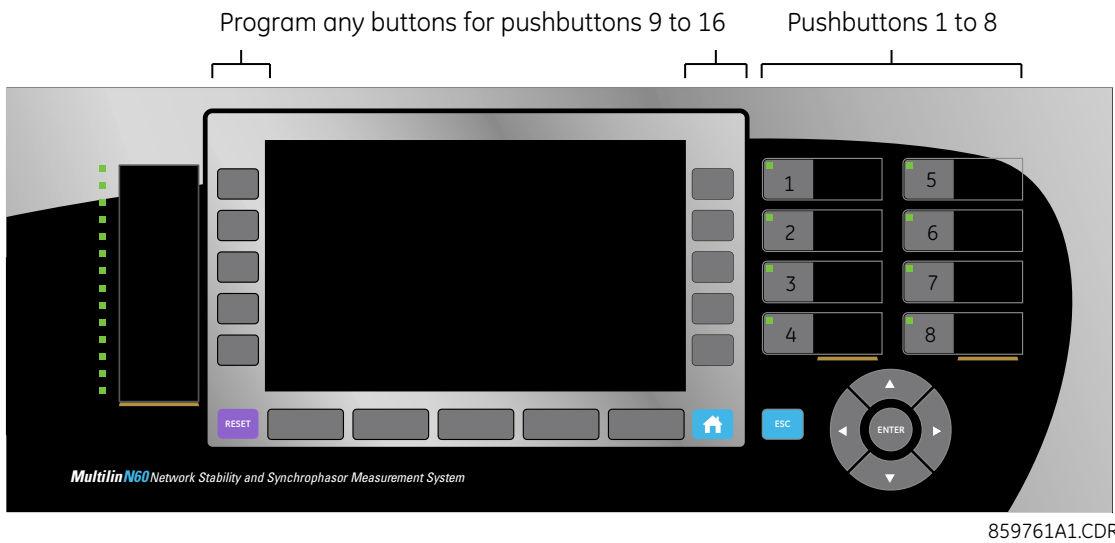


Figure 5-56: User-programmable pushbuttons (graphical front panel)



5

Front panel pushbuttons and LEDs can be custom labelled as outlined in the Front Panel Labelling section in the previous chapter.

Each pushbutton asserts its own “On” and “Off” FlexLogic operands (for example, [PUSHBUTTON 1 ON](#) and [PUSHBUTTON 1 OFF](#)). These operands are available for each pushbutton and are used to program specific actions. If any pushbutton is active, the [ANY PB ON](#) operand is asserted.

Each pushbutton has an associated LED indicator. By default, this indicator displays the present status of the corresponding pushbutton (on or off). However, each LED indicator can be assigned to any FlexLogic operand through the [PUSHBTN 1 LED CTL](#) setting.

The activation and deactivation of user-programmable pushbuttons depends on whether latched or self-reset mode is programmed.

- **Latched mode** — In latched mode, a pushbutton can be set (activated) by asserting the operand assigned to the [PUSHBTN 1 SET](#) setting, by directly pressing the associated front panel pushbutton, or with the graphical front panel

interface. The state of each pushbutton is stored in non-volatile memory and maintained through a loss of control power.

The pushbutton is reset (deactivated) in latched mode by asserting the operand assigned to the **PUSHBTN 1 RESET** setting, by directly pressing the active front panel pushbutton, or with the graphical front panel interface.

It can also be programmed to reset automatically through the **PUSHBTN 1 AUTORST** and **PUSHBTN 1 AUTORST DELAY** settings. These settings enable the autoreset timer and specify the associated time delay. The autoreset timer can be used in select-before-operate (SBO) breaker control applications, where the command type (close/open) or breaker location (feeder number) must be selected prior to command execution. The selection must reset automatically if control is not executed within a specified time period.

- **Self-reset mode** — In self-reset mode, a user-programmable pushbutton can be set (activated) by asserting the operand assigned to the **PUSHBTN 1 SET** setting, by pressing the front panel pushbutton, or by the graphical front panel interface. A pushbutton remains active for the time it is pressed physically or pressed in the graphical front panel interface, plus the dropout time specified in the **PUSHBTN 1 DROP-OUT TIME** setting. If the pushbutton is activated via FlexLogic, the pulse duration is specified by the **PUSHBTN 1 DROP-OUT TIME** only. The time the operand assigned to the **PUSHBTN 1 SET** setting remains On has no effect on the pulse duration.



The pulse duration of the remote set or local front panel pushbutton must be at least 50 ms to operate the pushbutton. This allows the user-programmable pushbuttons to properly operate during power cycling events and various system disturbances that can cause transient assertion of the operating signals.

The local and remote operation of each user-programmable pushbutton can be inhibited through the **PUSHBTN 1 LOCAL** and **PUSHBTN 1 REMOTE** settings. If local inhibit is applied, the pushbutton ignores set and reset commands executed through the front panel pushbuttons. If remote inhibit is applied, the pushbutton ignores set and reset commands executed through FlexLogic operands.

The inhibit functions are not applied to the autoreset feature. The inhibit function can be used in SBO control operations to prevent user-programmable pushbutton activation and ensuring “one-at-a-time” select operation.

The inhibit functions can also be used to prevent pushbutton activation from the accidental pressing of the front panel pushbuttons. The separate inhibit of the local and remote operation simplifies the implementation of local/remote control supervision.

Pushbutton states can be logged by the event recorder. User-defined messages can also be associated with each pushbutton and displayed on basic and enhanced front panels when the user-programmable pushbutton is activated, and when in the latched mode when the user-programmable pushbutton is deactivated. With the graphical front panel interface, instead of messages, the status of user-programmable pushbuttons can display on a single-line diagram and can also display in annunciator page windows and in actual values page cells.

For the graphical front panel, the pushbuttons 1 to 8 are linked to the eight physical pushbuttons, and pushbuttons 9 to 16 are mapped to the graphical interface pushbuttons. To set the buttons for pushbuttons 9 to 16, access **Settings > Product Setup > Graphical Panel > Single Line Diagram Editor**, click the PB symbol in the toolbox, then configure pushbuttons 9 to 16.

**PUSHBUTTON 1 FUNCTION** — This setting selects the mode of the pushbutton (Self-Reset, Latched, Disabled). If set to “Disabled,” the pushbutton is not active and the corresponding FlexLogic operands (both “On” and “Off”) are de-asserted. If set to “Latched,” the pushbutton remains on until reset.

**PUSHBTN 1 ID TEXT** — This setting specifies the top 20-character line of the user-programmable pushbutton message and is intended to provide ID information of the pushbutton. For example, the text displays in the Event Record. See the User-definable Displays section in this chapter for instructions on how to enter alphanumeric characters from the keypad. On a graphical front panel, this setting instead controls the label of the user-programmable pushbutton component on single-line diagrams.

**PUSHBTN 1 ON TEXT** — This setting specifies the bottom 20-character line of the user-programmable pushbutton message and is displayed when the pushbutton is in the “on” position. See the User-definable Displays section for instructions on entering alphanumeric characters from the keypad. On a graphical front panel, this setting instead controls the on status text of the user-programmable pushbutton component on single-line diagrams. This setting is not applied to the physical pushbuttons on the graphical front panel.

**PUSHBTN 1 OFF TEXT** — This setting specifies the bottom 20-character line of the user-programmable pushbutton message and displays when the pushbutton is deactivated and the **PUSHBUTTON 1 FUNCTION** is "Latched." A message does not display when the **PUSHBUTTON 1 FUNCTION** is "Self-reset" as the pushbutton operand status is implied to be "Off" upon its release. The length of the "Off" message is configured with the **PRODUCT SETUP** ⇒ **DISPLAY PROPERTIES** ⇒ **FLASH MESSAGE TIME** setting. On a graphical front panel, this setting instead controls the off status text of the user-programmable pushbutton component on single-line diagrams. This setting is not applied to the physical pushbuttons on the graphical front panel.

**PUSHBTN 1 HOLD** — This setting specifies the time required for a front panel pushbutton to be pressed before it is deemed active. This timer is reset upon release of the pushbutton. Note that user-programmable pushbutton operation requires the front panel pushbutton to be pressed a minimum of 50 ms. This minimum time is required prior to activating the user-programmable pushbutton hold timer.

**PUSHBTN 1 SET** — This setting assigns the FlexLogic operand serving to activate the user-programmable pushbutton element. The duration of the incoming set signal must be at least 50 ms.

**PUSHBTN 1 RESET** — This setting assigns the FlexLogic operand serving to deactivate the user-programmable pushbutton element. This setting is applicable only if the user-programmable pushbutton is in "Latched" mode.

**PUSHBTN 1 AUTORST** — This setting enables the user-programmable pushbutton autoreset feature. This setting is applicable only if the pushbutton is in "Latched" mode.

**PUSHBTN 1 AUTORST DELAY** — This setting specifies the time delay for automatic reset of the pushbutton when in "Latched" mode.

**PUSHBTN 1 REMOTE** — This setting assigns the FlexLogic operand serving to inhibit user-programmable pushbutton operation from the operand assigned to the **PUSHBTN 1 SET** or **PUSHBTN 1 RESET** settings.

**PUSHBTN 1 LOCAL** — This setting assigns the FlexLogic operand serving to inhibit user-programmable pushbutton operation from the front panel pushbuttons. This inhibit functionality is not applicable to pushbutton autoreset.

**PUSHBTN 1 DROP-OUT TIME** — This setting applies only to "Self-Reset" mode and specifies the duration of the user-programmable pushbutton active status after the front panel pushbutton or graphical front panel interface pushbutton has been released. When activated remotely, this setting specifies the entire activation time of the pushbutton; the length of time the operand selected by **PUSHBTN 1 SET** remains on has no effect on the pulse duration.

**PUSHBTN 1 LED CTL** — This setting assigns the FlexLogic operand serving to drive the front panel pushbutton LED. If this setting is "Off," then LED operation is directly linked to the **PUSHBUTTON 1 ON** operand. This setting is not applied to Pushbuttons 9 to 16 on the graphical front panel, where the label background shows the orange glow color for the "on" state.

**PUSHBTN 1 MESSAGE** — This setting controls the behavior of the user-programmable pushbutton on message that is programmed in the **PUSHBTN 1 ID** and **PUSHBTN 1 ON TEXT** settings, and the behavior of the user-programmable pushbutton off message that is programmed in the **PUSHBTN 1 ID** and **PUSHBTN 1 OFF TEXT** settings. This settings has no effect on the graphical front panel.

When set to "Disabled", user-programmable pushbutton messages do not display. Otherwise the on message displays when the user-programmable pushbutton becomes activated, and if in the "Latched" mode the off message displays when the user-programmable pushbutton becomes deactivated.

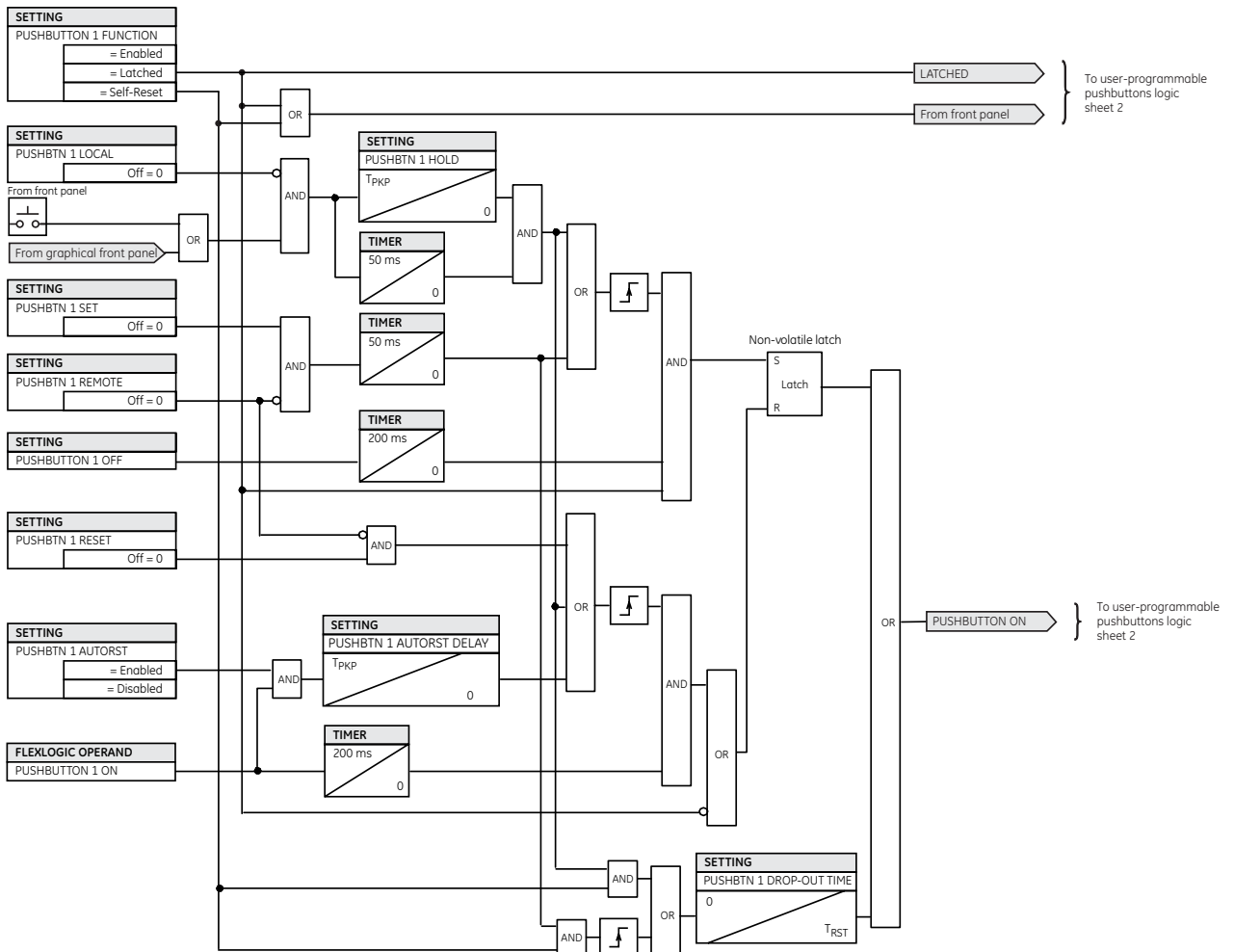
When set to "Normal", the duration the message displays is as specified by the **FLASH MESSAGE TIME** setting.

When set to "High Priority", the duration of the off message is as specified by the **FLASH MESSAGE TIME** setting, but the on message is displayed as long as the user-programmable pushbutton is activated. While activated, target and other messages are suppressed. To allow front panel keypad operation, when a keypad button is pressed the message is suppressed for 10 seconds.

**PUSHBUTTON 1 EVENTS** — If this setting is enabled, each user-programmable pushbutton state change is logged as an event into the event recorder.

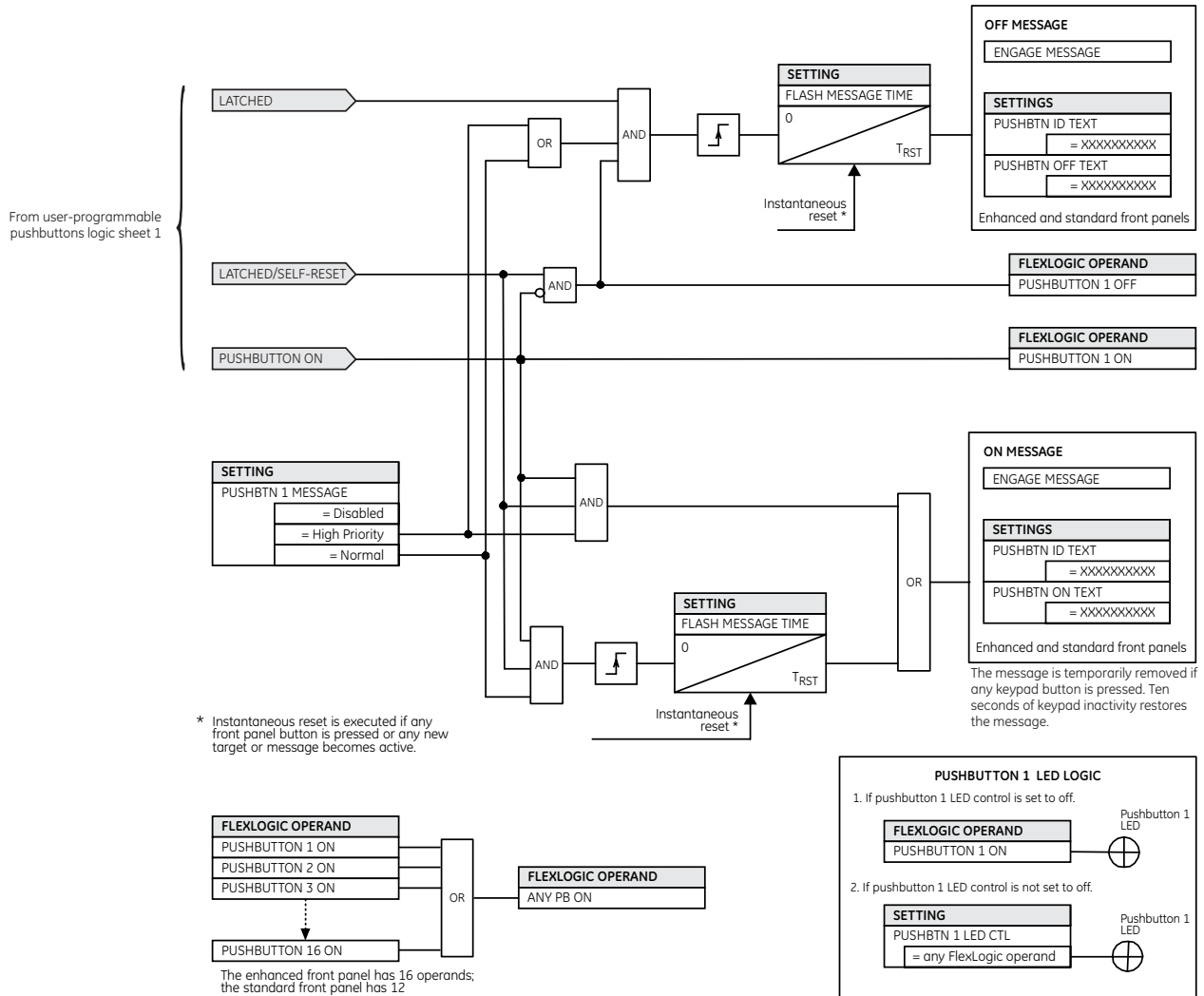
The figures show the user-programmable pushbutton logic.

Figure 5-57: User-programmable pushbutton logic (Sheet 1 of 2)



842237A1.CDR

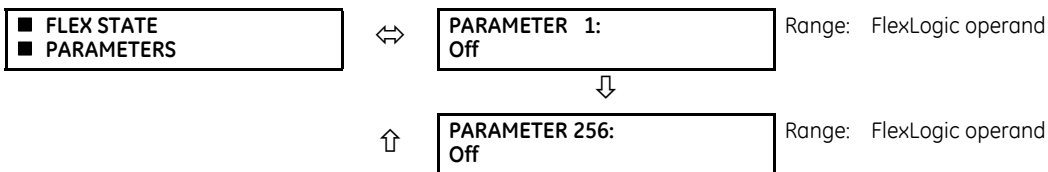
Figure 5-58: User-programmable pushbutton logic (Sheet 2 of 2)



842239A1.CDR

### 5.3.15 Flex state parameters

#### SETTINGS ⇒ PRODUCT SETUP ⇒ FLEX STATE PARAMETERS



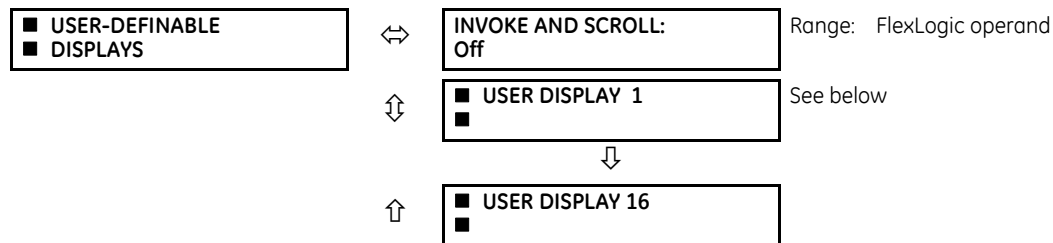
This feature provides a mechanism where any of 256 selected FlexLogic operand states can be used for efficient monitoring. The feature allows user-customized access to the FlexLogic operand states in the relay. The state bits are packed so that 16 states are readable in a single Modbus register. The state bits can be configured so that all states of interest are available in a minimum number of Modbus registers.

The state bits can be read out in the “Flex States” register array beginning at Modbus address 0900h. Sixteen states are packed into each register, with the lowest-numbered state in the lowest-order bit. Sixteen registers accommodate the 256 state bits.

## 5.3.16 User-definable displays

### 5.3.16.1 Menu

#### SETTINGS ⇒ PRODUCT SETUP ⇒ USER-DEFINABLE DISPLAYS



This feature is supported with enhanced and basic front panels.

This menu provides a mechanism for manually creating up to 16 user-defined information displays in a convenient viewing sequence in the **USER DISPLAY** menu (between the **TARGETS** and **ACTUAL VALUES** top-level menus). The sub-menus facilitate text entry and Modbus register data pointer options for defining the user display content.

This feature is not supported with the optional graphical front panel.

Once programmed, the user-definable displays can be viewed in two ways.

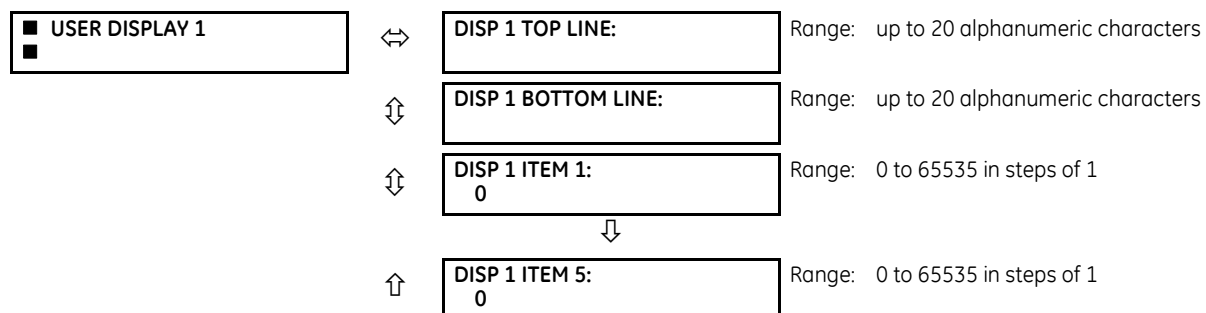
- **Keypad** — Use the **MENU** key to select the **USER DISPLAY** menu item to access the first user-definable display (note that only the programmed screens are displayed). The screens can be scrolled using the up and down arrow keys. The display disappears after the default message time-out period specified by the **PRODUCT SETUP ⇒ DISPLAY PROPERTIES ⇒ DEFAULT MESSAGE TIMEOUT** setting.
- **User-programmable control input** — The user-definable displays also respond to the **INVOKE AND SCROLL** setting. Any FlexLogic operand (in particular, the user-programmable pushbutton operands), can be used to navigate the programmed displays.

On the rising edge of the configured operand (such as when the pushbutton is pressed), the displays are invoked by showing the last user-definable display shown during the previous activity. From this moment onward, the operand acts exactly as the down key and allows scrolling through the configured displays. The last display wraps up to the first one. The **INVOKE AND SCROLL** input and the down arrow key operate concurrently.

When the default timer expires (set by the **DEFAULT MESSAGE TIMEOUT** setting), the relay starts to cycle through the user displays. The next activity of the **INVOKE AND SCROLL** input stops the cycling at the currently displayed user display, not at the first user-defined display. The **INVOKE AND SCROLL** pulses must last for at least 250 ms to take effect.

### 5.3.16.2 User display 1(16)

#### SETTINGS ⇒ PRODUCT SETUP ⇒ USER-DEFINABLE DISPLAYS ⇒ USER DISPLAY 1(16)



Any existing system display can be automatically copied into an available user display by selecting the existing display and pressing the **ENTER** key. The display then prompts with **ADD TO USER DISPLAY LIST?** After selecting "Yes," a message indicates that the selected display has been added to the user display list. When this type of entry occurs, the sub-menus are automatically configured with the proper content—this content can be edited subsequently.

This menu is used to enter user-defined text and user-selected Modbus-registered data fields into the particular user display. Each user display consists of two 20-character lines (top and bottom). The tilde (~) character is used to mark the start of a data field – the length of the data field needs to be accounted for. Up to five separate data fields can be entered in a user display – the *n*th tilde (~) refers to the *n*th item.

A user display can be entered from the front panel keypad or the EnerVista interface (preferred for convenience). The following procedure shows how to enter text characters in the top and bottom lines from the front panel keypad:

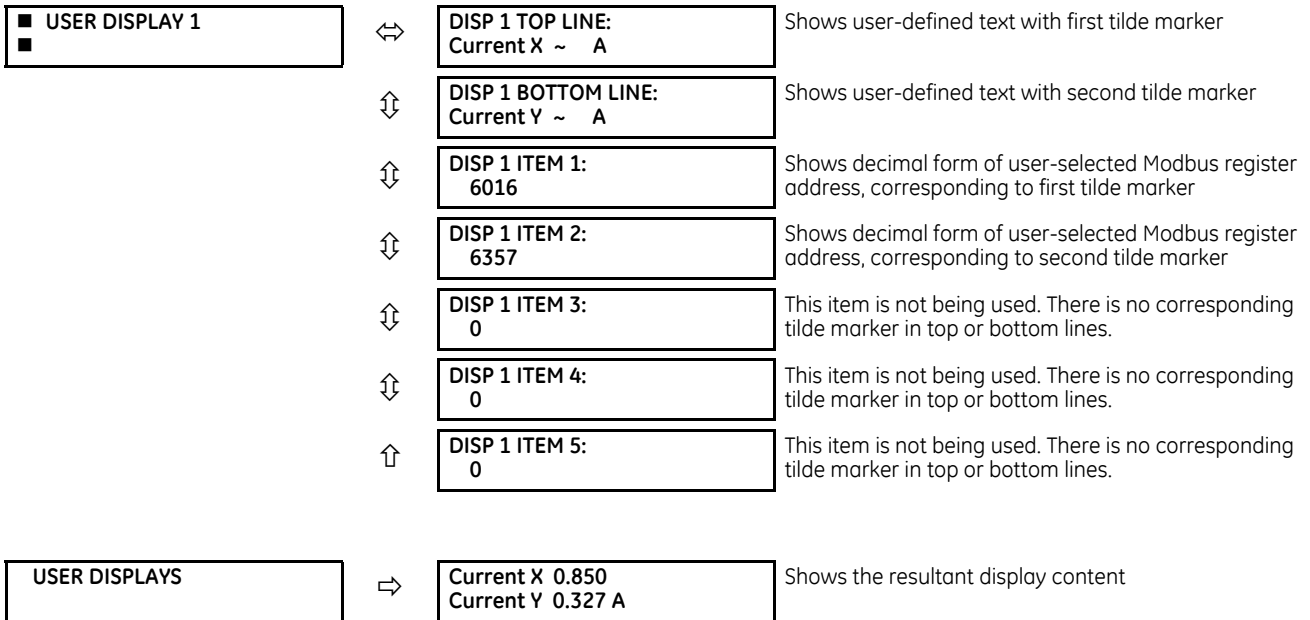
1. Select the line to be edited.
2. Press the decimal key to enter text edit mode.
3. Use either **VALUE** key to scroll through the characters. A space is selected like a character.
4. Press the decimal key to advance the cursor to the next position.
5. Repeat step 3 and continue entering characters until the desired text is displayed.
6. The **HELP** key can be pressed at any time for context sensitive help information.
7. Press the **ENTER** key to store the new settings.

To enter a numerical value for any of the five items (the *decimal form* of the selected Modbus address) from the front panel keypad, use the number keypad. Use the value of "0" for any items not being used. Use the **HELP** key at any selected system display (setting, actual value, or command) which has a Modbus address, to view the *hexadecimal form* of the Modbus address, then manually convert it to decimal form before entering it (EnerVista usage conveniently facilitates this conversion).

Use the **MENU** key to go to the user displays menu to view the user-defined content. The current user displays show in sequence, changing every four seconds. While viewing a user display, press the **ENTER** key and then select the "Yes" option to remove the display from the user display list. Use the **MENU** key again to exit the user displays menu.

An example of user display setup and result is shown as follows.

5



If the parameters for the top line and the bottom line items have the same units, then the unit is displayed on the bottom line only. The units are only displayed on both lines if the units specified both the top and bottom line items are different.



## 5.3.17 Direct inputs and outputs

### 5.3.17.1 Menu

SETTINGS ⇒ PRODUCT SETUP ⇒ DIRECT I/O

<input checked="" type="checkbox"/> DIRECT I/O <input checked="" type="checkbox"/>	↔	DIRECT OUTPUTS DEVICE ID: 1	Range: 1 to 16 in steps of 1
	↕	DIRECT I/O CH1 RING CONFIGURATION: Yes	Range: Yes, No
	↕	DIRECT I/O CH2 RING CONFIGURATION: Yes	Range: Yes, No
	↕	DIRECT I/O DATA RATE: 64 kbps	Range: 64 kbps, 128 kbps
	↕	DIRECT I/O CHANNEL CROSSOVER: Disabled	Range: Disabled, Enabled
	↕	<input checked="" type="checkbox"/> CRC ALARM CH1 <input checked="" type="checkbox"/>	See page 5-140
	↕	<input checked="" type="checkbox"/> CRC ALARM CH2 <input checked="" type="checkbox"/>	
	↕	<input checked="" type="checkbox"/> UNRETURNED <input checked="" type="checkbox"/> MESSAGES ALARM CH1	See page 5-141
	↑	<input checked="" type="checkbox"/> UNRETURNED <input checked="" type="checkbox"/> MESSAGES ALARM CH2	



This option is available when an Inter-Relay Communications card is specified at the time of ordering (see the Order Code tables). With the option, direct inputs/outputs display by default. When you enable the teleprotection feature, direct I/O is not visible.

Direct inputs and outputs exchange status information (inputs and outputs) between UR-series relays connected directly via type 7 digital communications cards. The mechanism is very similar to IEC 61850 GOOSE, except that communications takes place over a non-switchable isolated network and is optimized for speed. On type 7 cards that support two channels, direct output messages are sent from both channels simultaneously. This effectively sends direct output messages both ways around a ring configuration. On type 7 cards that support one channel, direct output messages are sent only in one direction. Messages are resent (forwarded) when it is determined that the message did not originate at the receiver.

Direct Inputs and Outputs are initiated automatically and start running once at least one Direct Output in the given UR is set to anything but Off.



NOTE

Teleprotection inputs/outputs and direct inputs/outputs are mutually exclusive. As such, they cannot be used simultaneously. Once teleprotection inputs and outputs are enabled, direct inputs and outputs are disabled, and vice versa.

Direct output message timing is similar to GOOSE message timing. Integrity messages (with no state changes) are sent at least every 1000 ms. Messages with state changes are sent within the main pass scanning the inputs and asserting the outputs unless the communication channel bandwidth has been exceeded. Two self-tests are performed and signaled by the following FlexLogic operands:

- **DIRECT RING BREAK** (direct input/output ring break). This FlexLogic operand indicates that direct output messages sent from a UR-series relay are not being received back by the relay.
- **DIRECT DEVICE 1 OFF** to **DIRECT DEVICE 16 OFF** (direct device offline). These FlexLogic operands indicate that direct output messages from at least one direct device are not being received.

Direct input and output settings are similar to remote input and output settings. The equivalent of the remote device name strings for direct inputs and outputs is the **DIRECT OUTPUT DEVICE ID** setting, which identifies the relay in all direct output messages. All UR-series IEDs in a ring need to have unique numbers assigned. The IED ID is used to identify the sender of the direct input and output message.

If the direct input and output scheme is configured to operate in a ring (**DIRECT I/O CH1 RING CONFIGURATION** or **DIRECT I/O CH2 RING CONFIGURATION** is "Yes"), all direct output messages are received back. If not, the direct input/output ring break self-test is triggered. The self-test error is signaled by the **DIRECT RING BREAK** FlexLogic operand.

Select the **DIRECT I/O DATA RATE** to match the data capabilities of the communications channel. All IEDs communicating over direct inputs and outputs must be set to the same data rate. UR-series IEDs equipped with dual-channel communications cards apply the same data rate to both channels. Delivery time for direct input and output messages is approximately 0.2 of a power system cycle at 128 kbps and 0.4 of a power system cycle at 64 kbps, per each "bridge."

**Table 5-17: Direct input and output data rates**

Module	Supported data rates
2A, 2B	64 kbps
2E, 2F	64 kbps
2G, 2H	128 kbps
2I, 2J	64 kbps, 128 kbps
72, 73	64 kbps, 128 kbps
74, 75	64 kbps
76, 77	64 kbps
7A, 7B, 7C, 7D	64 kbps, 128 kbps
7E, 7F, 7G	64 kbps
7H, 7I, 7J, 7K	64 kbps, 128 kbps
7L, 7M, 7N, 7P, 7Q	64 kbps
7R, 7S	64 kbps
7T, 7W	64 kbps

5



The G.703 modules are fixed at 64 kbps. The **DIRECT I/O DATA RATE** setting is not applicable to these modules.

NOTE

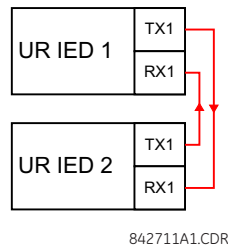
The **DIRECT I/O CHANNEL CROSSOVER** setting applies to a G30 with dual-channel communication cards and allows crossing over messages from channel 1 to channel 2. This places all UR-series IEDs into one direct input and output network regardless of the physical media of the two communication channels.

The following application examples illustrate the basic concepts for direct input and output configuration. See the Inputs and Outputs section in this chapter for information on configuring FlexLogic operands (flags, bits) to be exchanged.

**Example 1: Extending the input/output capabilities of a UR-series relay**

Consider an application that requires additional quantities of contact inputs or output contacts or lines of programmable logic that exceed the capabilities of a single UR-series chassis. The problem is solved by adding an extra UR-series IED, such as the C30, to satisfy the additional input and output and programmable logic requirements. The two IEDs are connected via single-channel digital communication cards as shown in the figure.

Figure 5-59: Input and output extension via direct inputs and outputs



In this application, apply the following settings. For UR-series IED 1:

- DIRECT OUTPUT DEVICE ID: "1"
- DIRECT I/O CH1 RING CONFIGURATION: "Yes"
- DIRECT I/O DATA RATE: "128 kbps"

For UR-series IED 2:

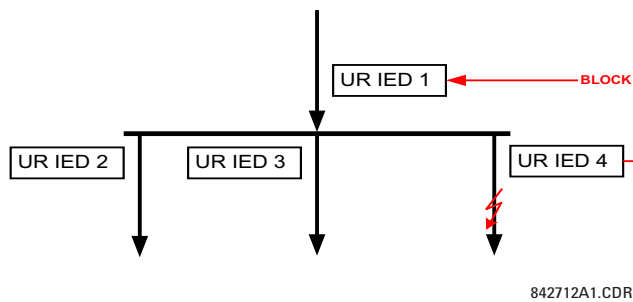
- DIRECT OUTPUT DEVICE ID: "2"
- DIRECT I/O CH1 RING CONFIGURATION: "Yes"
- DIRECT I/O DATA RATE: "128 kbps"

The message delivery time is about 0.2 of power cycle in both ways (at 128 kbps); that is, from device 1 to device 2, and from device 2 to device 1. Different communications cards can be selected by the user for this back-to-back connection (for example: fiber, G.703, or RS422).

### Example 2: Interlocking busbar protection

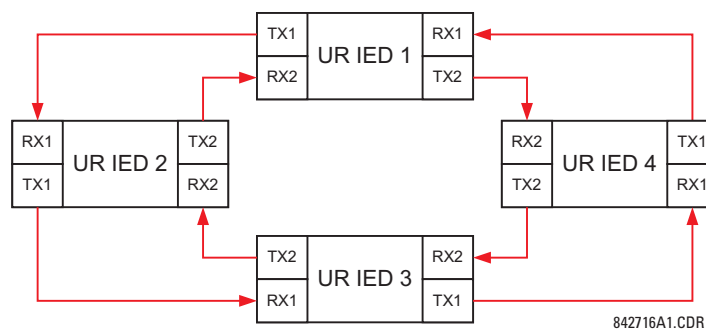
A simple interlocking busbar protection scheme could be accomplished by sending a blocking signal from downstream devices, say 2, 3, and 4, to the upstream device that monitors a single incomer of the busbar, as shown.

Figure 5-60: Sample interlocking busbar protection scheme



For increased reliability, a dual-ring configuration (shown as follows) is recommended for this application.

Figure 5-61: Interlocking bus protection scheme via direct inputs/outputs



In this application, apply the following settings. For UR-series IED 1:

DIRECT OUTPUT DEVICE ID: "1"  
 DIRECT I/O CH1 RING CONFIGURATION: "Yes"  
 DIRECT I/O CH2 RING CONFIGURATION: "Yes"

For UR-series IED 2:

DIRECT OUTPUT DEVICE ID: "2"  
 DIRECT I/O CH1 RING CONFIGURATION: "Yes"  
 DIRECT I/O CH2 RING CONFIGURATION: "Yes"

For UR-series IED 3:

DIRECT OUTPUT DEVICE ID: "3"  
 DIRECT I/O CH1 RING CONFIGURATION: "Yes"  
 DIRECT I/O CH2 RING CONFIGURATION: "Yes"

For UR-series IED 4:

DIRECT OUTPUT DEVICE ID: "4"  
 DIRECT I/O CH1 RING CONFIGURATION: "Yes"  
 DIRECT I/O CH2 RING CONFIGURATION: "Yes"

Message delivery time is approximately 0.2 of power system cycle (at 128 kbps) times number of 'bridges' between the origin and destination. Dual-ring configuration effectively reduces the maximum 'communications distance' by a factor of two.

In this configuration the following delivery times are expected (at 128 kbps) if both rings are healthy:

IED 1 to IED 2: 0.2 of power system cycle  
 IED 1 to IED 3: 0.4 of power system cycle  
 IED 1 to IED 4: 0.2 of power system cycle  
 IED 2 to IED 3: 0.2 of power system cycle  
 IED 2 to IED 4: 0.4 of power system cycle  
 IED 3 to IED 4: 0.2 of power system cycle

If one ring is broken (say TX2-RX2) the delivery times are as follows:

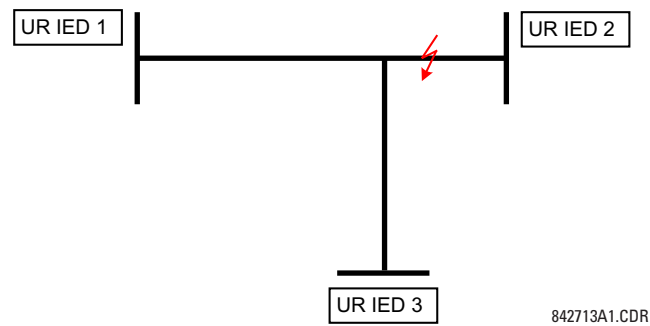
IED 1 to IED 2: 0.2 of power system cycle  
 IED 1 to IED 3: 0.4 of power system cycle  
 IED 1 to IED 4: 0.6 of power system cycle  
 IED 2 to IED 3: 0.2 of power system cycle  
 IED 2 to IED 4: 0.4 of power system cycle  
 IED 3 to IED 4: 0.2 of power system cycle

A coordinating timer for this bus protection scheme could be selected to cover the worst case scenario (0.4 of a power system cycle). Upon detecting a broken ring, the coordination time is adaptively increased to 0.6 of a power system cycle. The complete application requires addressing a number of issues, such as failure of both the communications rings, failure or out-of-service conditions of one of the relays, and so on. Self-monitoring flags of the direct inputs and outputs feature primarily are used to address these concerns.

### Example 3: Pilot-aided schemes

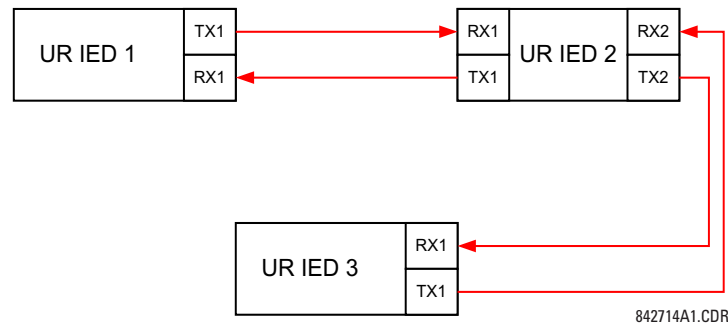
Consider the three-terminal line protection application shown.

Figure 5-62: Three-terminal line application



A permissive pilot-aided scheme can be implemented in a two-ring configuration, shown as follows (IEDs 1 and 2 constitute a first ring, while IEDs 2 and 3 constitute a second ring).

Figure 5-63: Single-channel open loop configuration



In this application, apply the following settings. For UR-series IED 1:

- DIRECT OUTPUT DEVICE ID: "1"
- DIRECT I/O CH1 RING CONFIGURATION: "Yes"
- DIRECT I/O CH2 RING CONFIGURATION: "Yes"

For UR-series IED 2:

- DIRECT OUTPUT DEVICE ID: "2"
- DIRECT I/O CH1 RING CONFIGURATION: "Yes"
- DIRECT I/O CH2 RING CONFIGURATION: "Yes"

For UR-series IED 3:

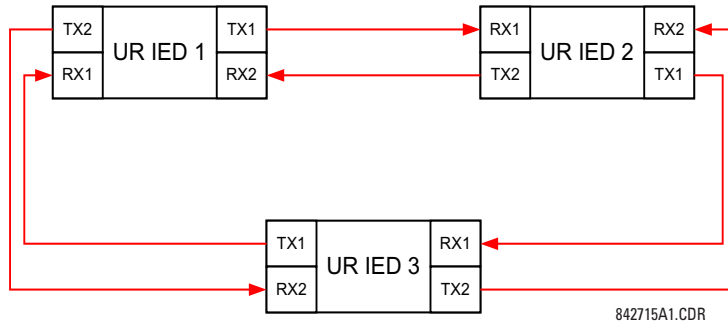
- DIRECT OUTPUT DEVICE ID: "3"
- DIRECT I/O CH1 RING CONFIGURATION: "Yes"
- DIRECT I/O CH2 RING CONFIGURATION: "Yes"

In this configuration the following delivery times are expected (at 128 kbps):

- IED 1 to IED 2: 0.2 of power system cycle
- IED 1 to IED 3: 0.5 of power system cycle
- IED 2 to IED 3: 0.2 of power system cycle

In this scheme, IEDs 1 and 3 do not communicate directly. IED 2 must be configured to forward the messages as explained in the Inputs and Outputs section. Implement a blocking pilot-aided scheme with more security and, ideally, faster message delivery time. This is accomplished using a dual-ring configuration as shown here.

Figure 5-64: Dual-channel closed loop (dual-ring) configuration



In this application, apply the following settings. For UR-series IED 1:

- DIRECT OUTPUT DEVICE ID: "1"
- DIRECT I/O CH1 RING CONFIGURATION: "Yes"
- DIRECT I/O CH2 RING CONFIGURATION: "Yes"

For UR-series IED 2:

- DIRECT OUTPUT DEVICE ID: "2"
- DIRECT I/O CH1 RING CONFIGURATION: "Yes"
- DIRECT I/O CH2 RING CONFIGURATION: "Yes"

For UR-series IED 3:

- DIRECT OUTPUT DEVICE ID: "3"
- DIRECT I/O CH1 RING CONFIGURATION: "Yes"
- DIRECT I/O CH2 RING CONFIGURATION: "Yes"

In this configuration the following delivery times are expected (at 128 kbps) if both the rings are healthy:

- IED 1 to IED 2: 0.2 of power system cycle
- IED 1 to IED 3: 0.2 of power system cycle
- IED 2 to IED 3: 0.2 of power system cycle

The two communications configurations can be applied to both permissive and blocking schemes. Take speed, reliability, and cost into account when selecting the required architecture.

### 5.3.17.2 CRC alarm CH1(2)

SETTINGS ⇒ PRODUCT SETUP ⇒ DIRECT I/O ⇒ CRC ALARM CH1(2)

<input checked="" type="checkbox"/> CRC ALARM CH1	⇔	CRC ALARM CH1 FUNCTION: Disabled	Range: Enabled, Disabled
	⇕	CRC ALARM CH1 MESSAGE COUNT: 600	Range: 100 to 10000 in steps of 1
	⇕	CRC ALARM CH1 THRESHOLD: 10	Range: 1 to 1000 in steps of 1
	⇕	CRC ALARM CH1 EVENTS: Disabled	Range: Enabled, Disabled

The G30 checks integrity of the incoming direct input and output messages using a 32-bit CRC. The CRC alarm function is available for monitoring the communication medium noise by tracking the rate of messages failing the CRC check. The monitoring function counts all incoming messages, including messages that failed the CRC check. A separate counter adds up messages that failed the CRC check. When the failed CRC counter reaches the user-defined level specified by the **CRC ALARM CH1 THRESHOLD** setting within the user-defined message count **CRC ALARM 1 CH1 COUNT**, the **DIR IO CH1 CRC ALARM** FlexLogic operand is set.

When the total message counter reaches the user-defined maximum specified by the **CRC ALARM CH1 MESSAGE COUNT** setting, both the counters reset and the monitoring process is restarted.

Configure the operand to drive an output contact, user-programmable LED, or selected communication-based output. Latching and acknowledging conditions—if required—are programmed accordingly.

The CRC alarm function is available on a per-channel basis. The total number of direct input and output messages that failed the CRC check is available as the **ACTUAL VALUES ⇒ STATUS ⇒ DIRECT INPUTS ⇒ CRC FAIL COUNT CH1** actual value.

- Message count and length of the monitoring window** — To monitor communications integrity, the relay sends 1 message per second (at 64 kbps) or 2 messages per second (at 128 kbps) even if there is no change in the direct outputs. For example, setting the **CRC ALARM CH1 MESSAGE COUNT** to “10000,” corresponds a time window of about 160 minutes at 64 kbps and 80 minutes at 128 kbps. If the messages are sent faster as a result of direct outputs activity, the monitoring time interval shortens. Take this into account when determining the **CRC ALARM CH1 MESSAGE COUNT** setting. For example, if the requirement is a maximum monitoring time interval of 10 minutes at 64 kbps, then the **CRC ALARM CH1 MESSAGE COUNT** is set to  $10 \times 60 \times 1 = 600$ .
- Correlation of failed CRC and bit error rate (BER)** — The CRC check can fail if one or more bits in a packet are corrupted. Therefore, an exact correlation between the CRC fail rate and the BER is not possible. Under certain assumptions an approximation can be made as follows. A direct input and output packet containing 20 bytes results in 160 bits of data being sent and therefore, a transmission of 63 packets is equivalent to 10,000 bits. A BER of  $10^{-4}$  implies 1 bit error for every 10000 bits sent or received. Assuming the best case of only 1 bit error in a failed packet, having 1 failed packet for every 63 received is about equal to a BER of  $10^{-4}$ .

### 5.3.17.3 Unreturned messages alarm CH1(2)

SETTINGS ⇒ PRODUCT SETUP ⇒ DIRECT I/O ⇒ UNRETURNED MESSAGES ALARM CH1(2)

<input checked="" type="checkbox"/> UNRETURNED <input checked="" type="checkbox"/> MESSAGES ALARM CH1	↔	UNRET MSGS ALARM CH1 FUNCTION: Disabled	Range: Enabled, Disabled
	↕	UNRET MSGS ALARM CH1 MESSAGE COUNT: 600	Range: 100 to 10000 in steps of 1
	↕	UNRET MSGS ALARM CH1 THRESHOLD: 10	Range: 1 to 1000 in steps of 1
	↑	UNRET MSGS ALARM CH1 EVENTS: Disabled	Range: Enabled, Disabled

The G30 checks integrity of the direct input and output communication ring by counting unreturned messages. In the ring configuration, all messages originating at a given device should return within a pre-defined period of time. The unreturned messages alarm function is available for monitoring the integrity of the communication ring by tracking the rate of unreturned messages. This function counts all the outgoing messages and a separate counter adds the messages have failed to return. When the unreturned messages counter reaches the user-definable level specified by the **UNRET MSGS ALARM CH1 THRESHOLD** setting and within the user-defined message count **UNRET MSGS ALARM CH1 COUNT**, the **DIR IO CH1 UNRET ALM** FlexLogic operand is set.

When the total message counter reaches the user-defined maximum specified by the **UNRET MSGS ALARM CH1 MESSAGE COUNT** setting, both the counters reset and the monitoring process is restarted.

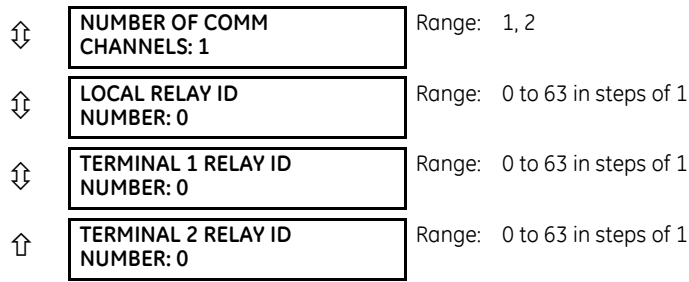
Configure the operand to drive an output contact, user-programmable LED, or selected communication-based output. Latching and acknowledging conditions, if required, are programmed accordingly.

The unreturned messages alarm function is available on a per-channel basis and is active only in the ring configuration. The total number of unreturned input and output messages is available as the **ACTUAL VALUES ⇒ STATUS ⇒ DIRECT INPUTS ⇒ UNRETURNED MSG COUNT CH1** actual value.

### 5.3.18 Teleprotection

SETTINGS ⇒ PRODUCT SETUP ⇒ TELEPROTECTION

<input checked="" type="checkbox"/> TELEPROTECTION <input checked="" type="checkbox"/>	↔	TELEPROTECTION FUNCTION: Disabled	Range: Disabled, Enabled
	↕	NUMBER OF TERMINALS: 2	Range: 2, 3



This option is available when an Inter-Relay Communications card is specified at the time of ordering (see the Order Code tables). With the option, direct inputs/outputs display by default. When you enable the teleprotection feature, direct I/O is not visible.

Digital teleprotection transfers protection commands between two or three relays in a secure, fast, dependable, and deterministic way. Possible applications are permissive or blocking pilot schemes and direct transfer trip (DTT). Teleprotection can be applied over any analog or digital channels and any communications media, such as direct fiber, copper wires, optical networks, or microwave radio links. A mixture of communication media is possible.

Once teleprotection is enabled and the teleprotection input/outputs are configured, data packets are transmitted continuously every 1/4 cycle (3/8 cycle if using C37.94 modules) from peer-to-peer. Security of communication channel data is achieved by using CRC-32 on the data packet.



Teleprotection inputs/outputs and direct inputs/outputs are mutually exclusive. As such, they cannot be used simultaneously. Once teleprotection inputs and outputs are enabled, direct inputs and outputs are blocked, and vice versa.

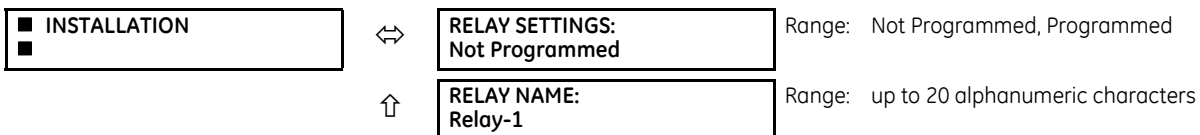
**NUMBER OF TERMINALS** — Specifies whether the teleprotection system operates between two peers or three peers.

**NUMBER OF CHANNELS** — Specifies how many channels are used. If the **NUMBER OF TERMINALS** is “3” (three-terminal system), set the **NUMBER OF CHANNELS** to “2.” For a two-terminal system, the **NUMBER OF CHANNELS** can set to “1” or “2” (redundant channels).

**LOCAL RELAY ID NUMBER, TERMINAL 1 RELAY ID NUMBER, and TERMINAL 2 RELAY ID NUMBER** — In installations that use multiplexers or modems, it is desirable to ensure that the data used by the relays protecting a given line is from the correct relays. The teleprotection function performs this check by reading the message ID sent by transmitting relays and comparing it to the programmed ID in the receiving relay. This check is also used to block inputs if inadvertently set to loopback mode or data is being received from a wrong relay by checking the ID on a received channel. If an incorrect ID is found on a channel during normal operation, the **TELEPROT CH1 ID FAIL** or **TELEPROT CH2 ID FAIL** FlexLogic operand is set, driving the event with the same name and blocking the teleprotection inputs. For commissioning purposes, the result of channel identification is also shown in the **STATUS ⇒ CHANNEL TESTS ⇒ VALIDITY OF CHANNEL CONFIGURATION** actual value. The default value of “0” for the **LOCAL RELAY ID NUMBER** indicates that relay ID is not to be checked. On two-terminal two-channel systems, the same **LOCAL RELAY ID NUMBER** is transmitted over both channels; as such, only the **TERMINAL 1 ID NUMBER** has to be programmed on the receiving end.

### 5.3.19 Installation

SETTINGS ⇒ PRODUCT SETUP ⇒ INSTALLATION



**RELAY SETTINGS** — To safeguard against the installation of a relay without any entered settings, the unit does not allow signaling of any output relay until **RELAY SETTINGS** is set to “Programmed.” This setting is “Not Programmed” by default. The UNIT NOT PROGRAMMED self-test error message displays until the relay is put into the “Programmed” state.

**RELAY NAME** — This setting allows the user to uniquely identify a relay. This name appears on generated reports.

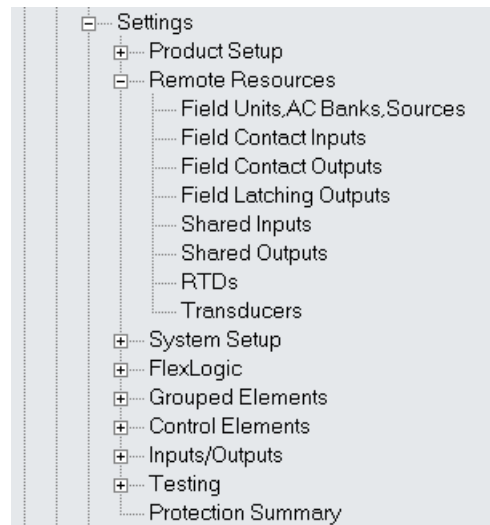


## 5.4 Remote resources

### 5.4.1 Remote resources configuration

When the G30 is ordered with a process card module as a part of HardFiber system, an additional **Remote Resources** menu tree is available in the EnerVista software to allow configuration of the HardFiber system.

Figure 5-65: Remote Resources configuration menu



The remote resources settings configure a G30 with a process bus module to work with HardFiber Bricks. Remote resources configuration is only available through the EnerVista software, and is not available through the G30 front panel. A Brick provides eight AC measurements, along with contact inputs, DC analog inputs, and contact outputs, to be the remote interface to field equipment such as circuit breakers and transformers. The G30 with a process bus module has access to all of the capabilities of up to eight Bricks. Remote resources settings configure the point-to-point connection between specific fiber optic ports on the G30 process card and specific Brick. The relay is then configured to measure specific currents, voltages and contact inputs from those Bricks, and to control specific outputs.

The configuration process for remote resources is straightforward and consists of the following steps.

- Configure the field units. This establishes the point-to-point connection between a specific port on the relay process bus module, and a specific digital core on a specific Brick. This is a necessary first step in configuring a process bus relay.
- Configure the AC banks. This sets the primary and secondary quantities and connections for currents and voltages. AC bank configuration also provides a provision for redundant measurements for currents and voltages, a powerful reliability improvement possible with process bus.
- Configure signal sources. This functionality of the G30 has not changed other than the requirement to use currents and voltages established by AC bank configuration under the remote resources menu.
- Configure field contact inputs, field contact outputs, RTDs, and transducers as required for the application's functionality. These inputs and outputs are the physical interface to circuit breakers, transformers, and other equipment. They replace the traditional contact inputs and outputs located at the relay to virtually eliminate copper wiring.
- Configure shared inputs and outputs as required for the application's functionality. Shared inputs and outputs are distinct binary channels that provide high-speed protection quality signaling between relays through a Brick.

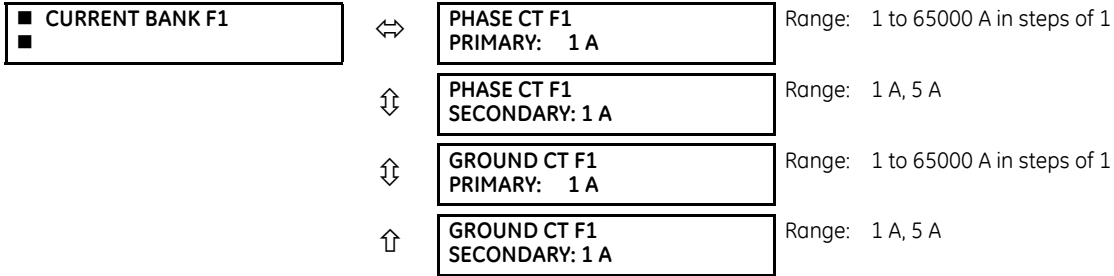
For additional information on how to configure a relay with a process bus module, see the HardFiber Process Bus System Instruction Manual.

## 5.5 System setup

### 5.5.1 AC inputs

#### 5.5.1.1 Current banks

SETTINGS ⇒ SYSTEM SETUP ⇒ AC INPUTS ⇒ CURRENT BANK F1(M5)



Because energy parameters are accumulated, record these values and then reset immediately prior to changing CT characteristics.

Four banks of phase and ground CTs can be set, where the current banks are denoted in the following format (X represents the module slot position letter):

Xa, where X = {F, M} and a = {1, 5}

See the Introduction to AC Sources section at the beginning of this chapter for details.

These settings are critical for all features that have settings dependent on current measurements. When the relay is ordered, the CT module must be specified to include a standard or sensitive ground input. As the phase CTs are connected in wye (star), the calculated phasor sum of the three phase currents ( $I_A + I_B + I_C = \text{neutral current} = 3I_0$ ) is used as the input for the neutral overcurrent elements. In addition, a zero-sequence (core balance) CT which senses current in all of the circuit primary conductors, or a CT in a neutral grounding conductor can also be used. For this configuration, the ground CT primary rating must be entered. To detect low level ground fault currents, the sensitive ground input can be used. In this case, the sensitive ground CT primary rating must be entered. See chapter 3 for more details on CT connections.

Enter the rated CT primary current values. For both 1000:5 and 1000:1 CTs, the entry would be 1000. For correct operation, the CT secondary rating must match the setting (which must also correspond to the specific CT connections used).

The following example illustrates how multiple CT inputs (current banks) are summed as one source current. Given the following current banks:

- F1: CT bank with 500:1 ratio
- F5: CT bank with 1000:1 ratio
- M1: CT bank with 800:1 ratio

The following rule applies:

$$SRC\ 1 = F1 + F5 + M1 \tag{Eq. 5-6}$$

1 pu is the highest primary current. In this case, 1000 is entered and the secondary current from the 500:1 and 800:1 ratio CTs are adjusted to that created by a 1000:1 CT before summation. If a protection element is set up to act on SRC 1 currents, then a pickup level of 1 pu operates on 1000 A primary.

The same rule applies for current sums from CTs with different secondary taps (5 A and 1 A).

#### 5.5.1.2 Voltage banks

SETTINGS ⇒ SYSTEM SETUP ⇒ AC INPUTS ⇒ VOLTAGE BANK F5(M5)



⇕	PHASE VT F5 SECONDARY: 66.4 V	Range: 25.0 to 240.0 V in steps of 0.1
⇕	PHASE VT F5 RATIO: 1.00 :1	Range: 1.00 to 24000.00 in steps of 0.01
⇕	AUXILIARY VT F5 CONNECTION: Vag	Range: Vn, Vag, Vbg, Vcg, Vab, Vbc, Vca
⇕	AUXILIARY VT F5 SECONDARY: 66.4 V	Range: 25.0 to 240.0 V in steps of 0.1
↑	AUXILIARY VT F5 RATIO: 1.00 :1	Range: 1.00 to 24000.00 in steps of 0.01

Because energy parameters are accumulated, these values should be recorded and then reset immediately prior to changing VT characteristics.

Two banks of phase/auxiliary VTs can be set, where voltage banks are denoted in the following format (X represents the module slot position letter):

Xa, where X = {F, M} and a = {5}

See the Introduction to AC Sources section at the beginning of this chapter for details.

With VTs installed, the relay can perform voltage measurements as well as power calculations. Enter the **PHASE VT F5 CONNECTION** made to the system as “Wye” or “Delta.” An open-delta source VT connection is entered as “Delta.”



The nominal **PHASE VT F5 SECONDARY** voltage setting is the voltage across the relay input terminals when nominal voltage is applied to the VT primary.

For example, on a system with a 13.8 kV nominal primary voltage and with a 14400:120 volt VT in a delta connection, the secondary voltage is 115; that is,  $(13800 / 14400) \times 120$ . For a wye connection, the voltage value entered must be the phase to neutral voltage, which is  $115 / \sqrt{3} = 66.4$ .

On a 14.4 kV system with a delta connection and a VT primary to secondary turns ratio of 14400:120, the voltage value entered is 120; that is,  $14400 / 120$ .

### 5.5.2 Power system

SETTINGS ⇌ SYSTEM SETUP ⇌ POWER SYSTEM

<input checked="" type="checkbox"/> POWER SYSTEM <input type="checkbox"/>	↔	NOMINAL FREQUENCY: 60 Hz	Range: 25 to 60 Hz in steps of 1
	⇕	PHASE ROTATION: ABC	Range: ABC, ACB
	⇕	REVERSE PH ROTATION: Off	Range: FlexLogic operand
	⇕	FREQUENCY AND PHASE REFERENCE: SRC 1	Range: SRC 1, SRC 2, SRC 3, SRC 4
	↑	FREQUENCYTRACKING: Enabled	Range: Disabled, Enabled

The power system **NOMINAL FREQUENCY** value is used as a default to set the digital sampling rate if the system frequency cannot be measured from available signals. This can happen if the signals are not present or are heavily distorted. Before reverting to the nominal frequency, the frequency tracking algorithm holds the last valid frequency measurement for a safe period of time while waiting for the signals to reappear or for the distortions to decay.

The phase sequence of the power system is required to properly calculate sequence components and power parameters. The **PHASE ROTATION** setting matches the power system phase sequence and informs the relay of the actual system phase sequence, either ABC or ACB. CT and VT inputs on the relay, labelled as A, B, and C, must be connected to system phases A, B, and C for correct operation.

The **REVERSE PH ROTATION** setting allows the user to dynamically change the phase rotation used for phasor calculations. This allows the G30 to follow the current phase rotation of the protected generator. For example, if the **PHASE ROTATION** setting is “ABC” but the condition defined for opposite phase rotation is true, then the phase rotation used for phasor calculation switches to “ACB.” This feature is only intended for use in special applications, such as pumped storage schemes.

Typical application of using Reverse Phase Rotation is the pumped-storage hydroelectricity application. Water is pumped from a lower elevation reservoir to a higher elevation (pumping or motor mode) during the off-peak period when low-cost surplus electricity is available, and during periods of high electrical demand, the stored water is released through turbines to produce electricity (generator mode), where pump operation is realized through phase rotation reversal operation because the hydraulic units are designed to operate as turbines when rotating in one direction and as pumps when rotating in the opposite direction.

When the operand assigned to the **REVERSE PH ROTATION** setting is logical “0,” the phase rotation is matching the one defined by the **PHASE ROTATION** setting, ABC for example. When this operand is logical “1,” the phase rotation changes to the opposite, ACB for the same example. Note that after successful rotation switching, the next switching is allowed only after nine power cycles.

Typically, different relay setting groups are used to protect pumping operation mode and generating operation mode of the hydraulic units respectively, therefore the logic for switching setting groups can be directly used to control the **REVERSE PH ROTATION**.

Every time rotation change is performed, protection is blocked for three power cycles.

The **FREQUENCY AND PHASE REFERENCE** setting determines which signal source is used (and hence which AC signal) for phase angle reference. The AC signal used is prioritized based on the AC inputs configured for the signal source. Phase voltages takes precedence, followed by auxiliary voltage, then phase currents, and finally ground current.

For three phase selection, phase A is used for angle referencing ( $V_{\text{ANGLE REF}} = V_A$ ), while Clarke transformation of the phase signals is used for frequency metering and tracking ( $V_{\text{FREQUENCY}} = (2V_A - V_B - V_C) / 3$ ) for better performance during fault, open pole, and VT and CT fail conditions.

The phase reference and frequency tracking AC signals are selected based upon the source configuration, regardless of whether or not a particular signal is actually applied to the relay.

Phase angle of the reference signal always displays zero degrees and all other phase angles are relative to this signal. If the pre-selected reference signal is not measurable at a given time, the phase angles are not referenced.

The phase angle referencing is done via a phase locked loop, which can synchronize independent UR-series relays if they have the same AC signal reference. This results in very precise correlation of phase angle indications between different UR-series relays.

**FREQUENCY TRACKING** is set to “Disabled” only in unusual circumstances; consult GE Grid Solutions for special variable-frequency applications.



The frequency tracking feature functions only when the G30 is in the “Programmed” mode. If the G30 is “Not Programmed,” then metering values are available but can exhibit significant errors.



Systems with an ACB phase sequence require special consideration. See the Phase Relationships of Three-phase Transformers section of chapter 5.

### 5.5.3 Signal sources

SETTINGS ⇒ SYSTEM SETUP ⇒ SIGNAL SOURCES ⇒ SOURCE 1(4)

<input type="checkbox"/> SOURCE 1	↔	SOURCE 1 NAME: SRC 1	Range: up to 20 alphanumeric characters
	↕	SOURCE 1 PHASE CT: None	Range: None, F1,... up to any 6 CTs. Only Phase CT inputs are displayed.

↕	SOURCE 1 GROUND CT: None	Range: None, F1,... up to any 6 CTs. Only Ground CT inputs are displayed.
↕	SOURCE 1 PHASE VT: None	Range: None, F5, M5 Only phase voltage inputs are displayed
↑	SOURCE 1 AUX VT: None	Range: None, F5, M5 Only auxiliary voltage inputs are displayed

Identical menus are available for each source. The "SRC 1" text can be replaced by with a user-defined name appropriate for the associated source.

The first letter in the source identifier represents the module slot position. The number directly following this letter represents either the first bank of four channels (1, 2, 3, 4) called "1" or the second bank of four channels (5, 6, 7, 8) called "5" in a particular CT/VT module. See the Introduction to AC Sources section at the beginning of this chapter for details.

It is possible to select the sum of all CT combinations. The first channel displayed is the CT to which all others are referred. For example, the selection "F1+F5" indicates the sum of each phase from channels "F1" and "F5," scaled to whichever CT has the higher ratio. Selecting "None" hides the associated actual values.

The approach used to configure the AC sources consists of several steps; first step is to specify the information about each CT and VT input. For CT inputs, this is the nominal primary and secondary current. For VTs, this is the connection type, ratio and nominal secondary voltage. Once the inputs have been specified, the configuration for each source is entered, including specifying which CTs are summed together.

### 5.5.3.1 User selection of AC parameters for comparator elements

CT/VT modules automatically calculate all current and voltage parameters from the available inputs. Users must select the specific input parameters to be measured by every element in the relevant settings menu. The internal design of the element specifies which type of parameter to use and provides a setting for source selection. In elements where the parameter can be either fundamental or RMS magnitude, such as phase time overcurrent, two settings are provided. One setting specifies the source, the second setting selects between fundamental phasor and RMS.

### 5.5.3.2 AC input actual values

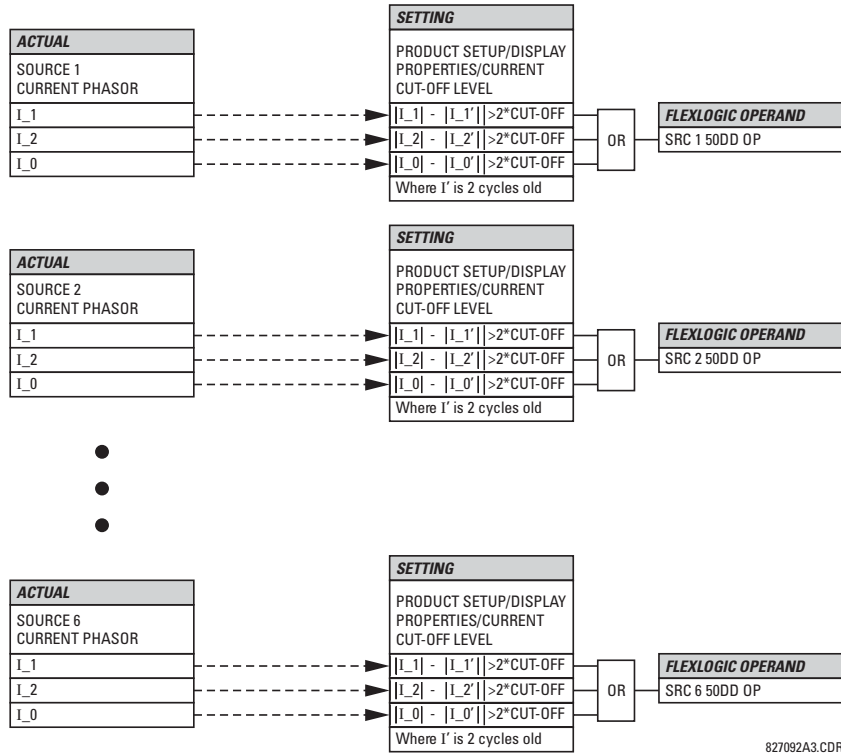
The calculated parameters associated with the configured voltage and current inputs are displayed in the current and voltage sections of actual values. Only the phasor quantities associated with the actual AC physical input channels display here. All parameters contained within a configured source are displayed in the sources section of the actual values.

### 5.5.3.3 Disturbance detectors (internal)

The disturbance detector (ANSI 50DD) element is a sensitive current disturbance detector that detects any disturbance on the protected system. The 50DD function is used directly in some elements in the relay, for example VT Fuse Failure detector or Fault Report. It can also be used to supervise current-based elements to prevent maloperation as a result of the wrong settings or external CT wiring problem. A disturbance detector is provided for each source.

The 50DD function responds to the changes in magnitude of the sequence currents. The disturbance detector logic is as follows.

Figure 5-66: Disturbance detector logic



5

The disturbance detector responds to the change in currents of twice the current cut-off level. The default cut-off threshold is 0.02 pu; thus by default the disturbance detector responds to a change of 0.04 pu. The metering sensitivity setting (PRODUCT SETUP ⇒ DISPLAY PROPERTIES ⇒ CURRENT CUT-OFF LEVEL) controls the sensitivity of the disturbance detector accordingly.

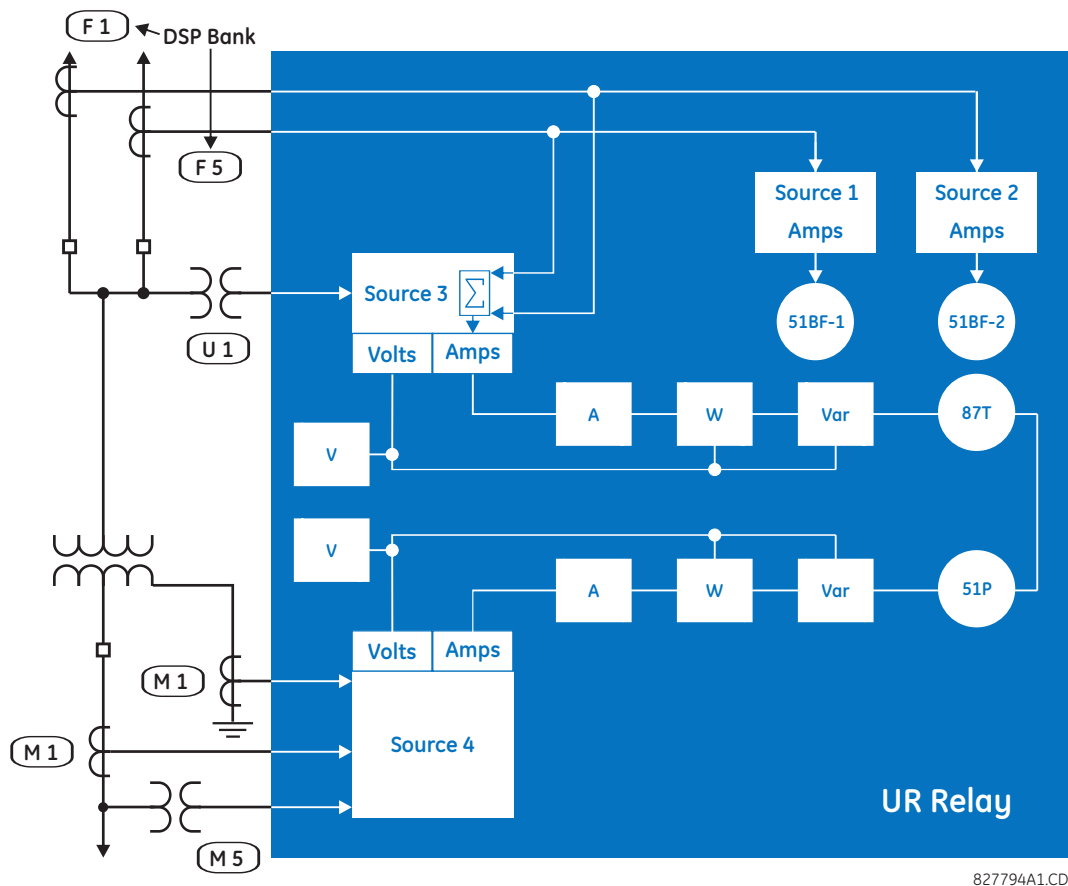
5.5.3.4 Example for use of sources

An example of the use of sources is shown in the following figure. A relay can have the following hardware configuration:

UR	Increasing slot position letter -->		
	CT/VT module 1	CT/VT module 2	CT/VT module 3
B30, B90, C70, F35, N60, T35	8 CTs	4 CTs, 4 VTs	4 CTs, 4 VTs
C60, D60, G30, G60, L30, L90, M60, T60	CTs	VTs	not applicable

This configuration can be used on a two-winding transformer, with one winding connected into a breaker-and-a-half system. The following figure shows the arrangement of sources used to provide the functions required in this application, and the CT/VT inputs that are used to provide the data.

Figure 5-67: Example of use of sources



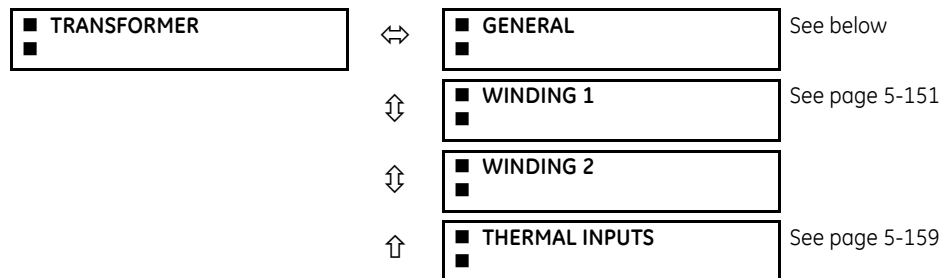
827794A1.CDR

	Y LV	D HV	AUX
	SRC 1	SRC 2	SRC 3
Phase CT	M1	F1+F5	None
Ground CT	M1	None	None
Phase VT	M5	None	None
Aux VT	None	None	U1

### 5.5.4 Transformer

#### 5.5.4.1 Menu

SETTINGS ⇄ SYSTEM SETUP ⇄ TRANSFORMER



### 5.5.4.2 General transformer settings

SETTINGS ⇅ SYSTEM SETUP ⇅ TRANSFORMER ⇅ GENERAL

<input checked="" type="checkbox"/> GENERAL	↔	REFERENCE WINDING: Automatic Selection	Range: Automatic Selection, Winding 1, Winding 2
	↑	PHASE COMPENSATION: Internal (software)	Range: Internal (software), External (with CTs)

The general transformer settings apply to all windings. Settings specific to each winding are shown in the following section.

**REFERENCE WINDING** — Reference winding is the winding to which all currents are referred. That is, the currents from all other windings are normalized (magnitude compensation) to this winding, and the per unit value of the differential currents, the restraint currents, and the corresponding differential characteristics (pickup, break points, and so on) are all based on the CT Nominal of this winding. The reference winding can be selected either automatically or manually. When automatic reference winding selection is chosen, the winding with the smallest margin of CT primary current with respect to the winding rated current is selected as the reference winding (see details in Magnitude Compensation section later in this chapter).

**NOTE** In some applications where CT primary of the winding is much higher than the winding rated current, automatic selection of reference winding can result in excessive magnitude compensation factor, and as a result can cause the winding current clipping. Therefore, with the automatic selection of the reference winding, further checking is required to ensure no winding currents after magnitude compensation can exceed 46 pu. If this happens, use manual selection of reference winding to avoid this. See the T35/T60 Reference Winding Selection and CT Ratio Mismatch Application Note ([GET-8548](#)) for information.

**PHASE COMPENSATION** — Selects the type of phase compensation to be performed by the relay.

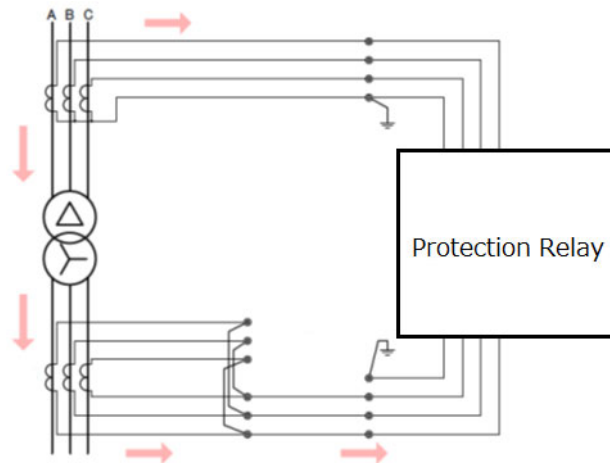
If set to “Internal (software)”, the transformer phase shift is compensated internally by the relay algorithm.

If set to “External (with CTs)”, the transformer phase shift is externally compensated by the CT connections. The Delta connected CTs on the Wye winding compensate the phase shift of the currents between the transformer primary and secondary windings (see the following figure). This is the old way of phase compensation.

And also to measure the currents on both sides of the transformer that correspond to the transformation ratio, divide the CT primary by SQRT 3. This compensates for the increase of SQRT 3 caused by the Delta CT connection.

Therefore, the Actual Value of current and power cannot be used for measurements in this case.

**Figure 5-68: Wye winding and Delta CT connection**





### 5.5.4.3 Windings

SETTINGS ⇒ SYSTEM SETUP ⇒ TRANSFORMER ⇒ WINDING 1(2)

<div style="border: 1px solid black; padding: 5px;"> <p>■ WINDING 1</p> <p>■</p> </div>	↔	<p>WINDING 1 SOURCE: SRC 1</p>	Range: SRC 1, SRC 2, SRC 3, SRC 4 (or the user-defined name)
	⇕	<p>WINDING 1 RATED MVA: 100.000 MVA</p>	Range: 0.001 to 2000.000 MVA in steps of 0.001
	⇕	<p>WINDING 1 NOM <math>\phi</math>-<math>\phi</math> VOLTAGE: 220.000 kV</p>	Range: 0.001 to 2000.000 kV in steps of 0.001
	⇕	<p>WINDING 1 CONNECTION: Wye</p>	Range: Wye, Delta, Zig-zag
	⇕	<p>WINDING 1 GROUNDING: Not within zone</p>	Range: Not within zone, Within zone
	↑	<p>WINDING ~ ANGLE WRT WINDING 1: 0.0°</p>	Range: -359.9 to 0.0° in steps of 0.1, ('~' > 1) (shown when viewed Winding is not Winding 1)



The G30 is provided with this optional feature, specified as an option at the time of ordering. Using the order code for your device, see the order codes in chapter 2 for details.

The settings specific to each winding are shown in the table.

The following discussion applies to a G30 device protecting the generator step-up (GSU) transformer, assuming that the LV winding CTs are on the neutral side of the generator and the HV winding CTs are on the system side of the step-up delta-wye transformer. It is also assumed that CTs are differentially connected as per regular transformer differential applications, as shown in the Typical Wiring, VT on the LV Side of the Transformer diagram in the Applications of Settings chapter.



The flexibility of G30 phase compensation allows the wiring of CTs to have polarities looking inside the protected zone or looking into the system. This can be needed to provide correct forward metered power at both sides of the GSU. When CTs are differentially connected (wired with polarities both pointing inside the zone), the angle between winding currents should be 0° plus an additional phase shift caused by the wye-delta connection of the transformer. When CTs are wired to point into the system, the angle between winding currents should be 180° plus an additional phase shift caused by the wye-delta connection of the transformer. Therefore, the adopted CTs polarities must be taken into account in the **SYSTEM SETUP ⇒ TRANSFORMER** settings menu. See the Applications of Settings chapter for examples of setting up G30 transformer differential protection with different CT polarity options.

Transformer differential protection uses the following calculated quantities (per phase): fundamental, second harmonic, and fifth harmonic differential current phasors, and restraint current phasors. This information is extracted from the current transformers (CTs) connected to the relay by correcting the magnitude and phase relationships of the currents for each winding, so as to obtain zero (or near zero) differential currents under normal operating conditions. Traditionally, these corrections were accomplished by interposing CTs and tapped relay windings with some combination of CT connections.

The G30 simplifies these configuration issues. All CTs at the transformer are connected wye (polarity markings pointing away from the transformer). User-entered settings in the relay characterizing the transformer being protected and allow the relay to automatically perform all necessary magnitude, phase angle, and zero-sequence compensation.

This section describes the algorithms in the relay that perform this compensation and produce the required calculated quantities for transformer differential protection, by means of the following example of a delta-wye ( $\Delta$ -Y) connected power transformer with the following data:

**Table 5-18: Example of delta-wye connected power transformer data**

Data	Winding 1 Δ (delta) connection	Winding 2 Y (wye) connection
Voltage Phasor Diagram		
Phase Shift	0°	30° lag (i.e. phases of wye winding lag corresponding phases of delta winding by 30°)
Grounding	In-zone grounding bank	Ungrounded
Rated MVA	100/133/166 MVA	100/133/166 MVA
Nominal φ-φ Voltage	220 kV	69 kV
CT Connection	Wye	Wye
CT Ratio	500/5	1500/5
Auxiliary Cooling	Two stages of forced air	Two stages of forced air

The abbreviated nomenclature for applicable relay settings is as follows:

Rotation = SETTINGS ⇒ SYSTEM SETUP ⇒ POWER SYSTEM ⇒ PHASE ROTATION

$W_{total}$  = SETTINGS ⇒ SYSTEM SETUP ⇒ TRANSFORMER ⇒ GENERAL ⇒ NUMBER OF WINDINGS

Compensation = SETTINGS ⇒ SYSTEM SETUP ⇒ TRANSFORMER ⇒ GENERAL ⇒ PHASE COMPENSATION

Source [w] = SETTINGS ⇒ SYSTEM SETUP ⇒ TRANSFORMER ⇒ WINDING w ⇒ WINDING w SOURCE

$P_{rated}$  [w] = SETTINGS ⇒ SYSTEM SETUP ⇒ TRANSFORMER ⇒ WINDING w ⇒ WINDING w RATED MVA

$V_{nominal}$  [w] = SETTINGS ⇒ SYSTEM SETUP ⇒ TRANSFORMER ⇒ WINDING w ⇒ WINDING w NOM F-F VOLTAGE

Connection [w] = SETTINGS ⇒ SYSTEM SETUP ⇒ TRANSFORMER ⇒ WINDING w ⇒ WINDING w CONNECTION

Grounding [w] = SETTINGS ⇒ SYSTEM SETUP ⇒ TRANSFORMER ⇒ WINDING w ⇒ WINDING w GROUNDING

$\Phi$ [w] = SETTINGS ⇒ SYSTEM SETUP ⇒ TRANSFORMER ⇒ WINDING w ⇒ WINDING w ANGLE WRT WINDING 1

CT primary [w] = the phase CT primary associated with Source [w]

**Note that w = winding number, 1 to  $w_{total}$**

The following transformer setup rules must be observed:

- The angle for the first winding from the transformer setup must be 0°, and the angles for the following windings must be entered as negative (lagging) with respect to (WRT) the winding 1 angle
- The “Within zone” and “Not within zone” setting values refer to whether the winding is grounded. Select “Within zone” if a neutral of a wye type winding, or a corner of a delta winding, is grounded within the zone, or whenever a grounding transformer falls into the zone of protection.

#### 5.5.4.4 Phase relationships of three-phase transformers

Power transformers that are built in accordance with ANSI and IEC standards are required to identify winding terminals and phase relationships among the windings of the transformer.

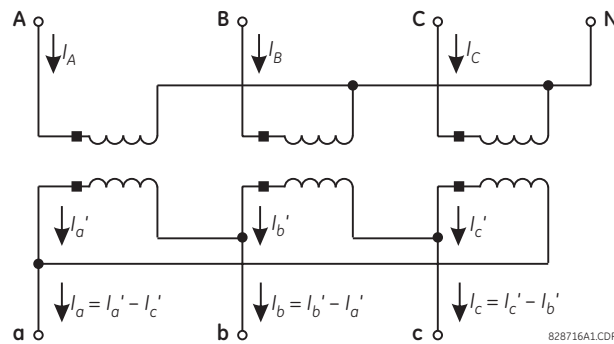
ANSI standard C.37.12.70 requires that the terminal labels include the characters 1, 2, 3 to represent the names of the individual phases. The phase relationship among the windings must be shown as a phasor diagram on the nameplate, with the winding terminals clearly labeled. This standard states that the phase relationships are established for a condition where the source phase sequence of 1-2-3 is connected to transformer windings labeled 1, 2, and 3 respectively.

IEC standard 60076-1 (1993) states that the terminal markings of the three phases follow national practice. The phase relationship among the windings is shown as a specified notation on the nameplate, and there can be a phasor diagram. In this standard, the arbitrary labeling of the windings is shown as I, II, and III. This standard states that the phase relationships are established for a condition where a source phase sequence of I-II-III is connected to transformer windings labeled I, II, and III respectively.

The reason the source phase sequence must be stated when describing the winding phase relationships is that these relationships change when the phase sequence changes. The following example shows why this happens, using a transformer described in IEC nomenclature as a type “Yd1” or in GE Multilin nomenclature as a “Y/d30.”

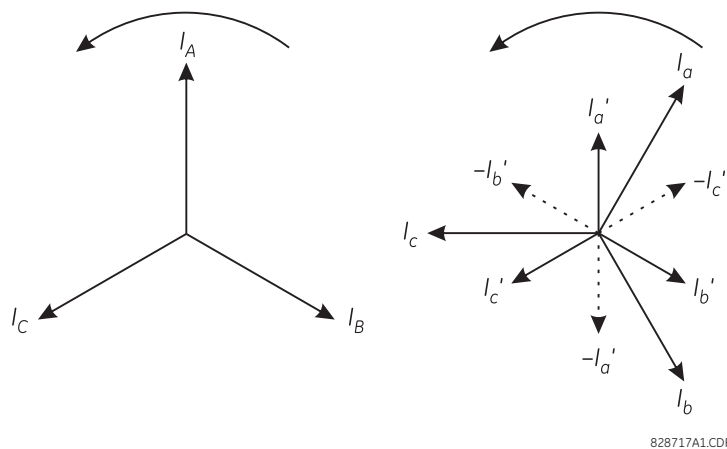
The example shows the physical connections within the transformer that produce a phase angle in the delta winding that lag the respective wye winding by 30°. The currents in the windings are also identified. Note that the total current out of the delta winding is described by an equation.

Figure 5-69: Example of transformer



Now assume that a source, with a sequence of ABC, is connected to transformer terminals ABC respectively. The currents then present for a balanced load are shown in the following figure.

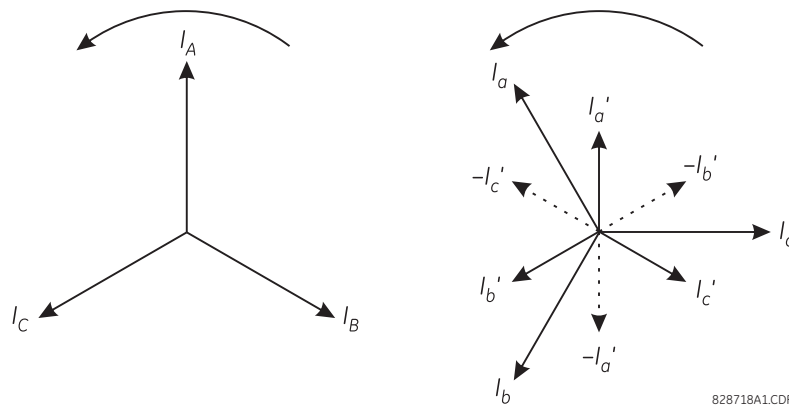
Figure 5-70: Phasors for ABC sequence



Note that the delta winding currents lag the wye winding currents by 30° (in agreement with the transformer nameplate).

Now assume that a source, with a sequence of ACB is connected to transformer terminals ACB respectively. The currents present for a balanced load are shown in the following figure.

Figure 5-71: Phasors for ACB sequence



Note that the delta winding currents leads the wye winding currents by  $30^\circ$ , (which is a type Yd11 in IEC nomenclature and a type Y/d330 in GE Multilin nomenclature) and which is in disagreement with the transformer nameplate. This is because the physical connections and hence the equations used to calculate current for the delta winding have not changed. The transformer nameplate phase relationship information is only correct for a stated phase sequence.

Phase relationship for the ACB sequence can be returned the transformer nameplate values by connecting source phases A, B, and C to transformer terminals A, C, and B respectively. Although this restores the nameplate phase shifts, it causes incorrect identification of phases B and C within the relay and is therefore not recommended.

All information presented in this manual is based on connecting the relay phase A, B, and C terminals to the power system phases A, B, and C respectively. The transformer types and phase relationships presented are for a system phase sequence of ABC, in accordance with the standards for power transformers. Users with a system phase sequence of ACB must determine the transformer type for this sequence.

If a power system with ACB rotation is connected to the Wye winding terminals 1, 2, and 3, respectively, from a Y/d30 transformer, select a Power Rotation setting of ACB in the relay and enter data for the Y/d330 transformer type.

#### 5.5.4.5 Magnitude compensation

Transformer protection presents problems in the application of current transformers. CTs should be matched to the current rating of each transformer winding, so that normal current through the power transformer is equal on the secondary side of the CT on different windings. However, because only standard CT ratios are available, this matching is not always exact.

In our example, the transformer has a voltage ratio of 220 kV / 69 kV (that is, about 3.188 to 1) and a compensating CT ratio is 500 A to 1500 A (that is, 1 to 3). Historically, this would have resulted in a steady state current at the differential relay. Interposing CTs or tapped relay windings were used to minimize this error.

The G30 automatically corrects for CT mismatch errors. All currents are magnitude compensated to be in units of the CTs of one winding before the calculation of differential and restraint quantities.

The reference winding ( $w_{ref}$ ) is the winding to which all currents are referred. This means that the differential and restraint currents are in per unit of nominal of the CTs on the reference winding. This is important to know because the settings of the operate characteristic of the percent differential element (pickup, breakpoints 1 and 2) are entered in terms of the same per unit of nominal.

The reference winding is chosen by the relay to be the winding that has the smallest margin of CT primary current with respect to winding rated current, meaning that the CTs on the reference winding most likely begin to saturate before those on other windings with heavy through currents. The characteristics of the reference winding CTs determine how the percent differential element operate characteristic need to be set.

The G30 determines the reference winding as follows:

1. Calculate the rated current ( $I_{rated}$ ) for each winding:

$$I_{rated}[w] = \frac{P_{rated}[w]}{\sqrt{3} \times V_{nom}[w]}, \text{ where } w = 1, 2 \quad \text{Eq. 5-7}$$

**Note: enter the self-cooled MVA rating for the  $P_{rated}$  setting.**

2. Calculate the CT margin ( $I_{margin}$ ) for each winding:

$$I_{margin} = \frac{CT_{primary}[w]}{I_{rated}[w]}, \text{ where } w = 1, 2 \quad \text{Eq. 5-8}$$

3. Choose the winding with the lowest CT margin.

In our example, the reference winding is chosen as follows.

1. Calculate the rated current for windings 1 and 2:

$$I_{rated}[1] = \frac{P_{rated}[1]}{\sqrt{3} \times V_{nom}[1]} = \frac{100 \text{ MVA}}{\sqrt{3} \times 220 \text{ kV}} = 262.4 \text{ A}, \quad I_{rated}[2] = \frac{P_{rated}[2]}{\sqrt{3} \times V_{nom}[2]} = \frac{100 \text{ MVA}}{\sqrt{3} \times 69 \text{ kV}} = 836.7 \text{ A} \quad \text{Eq. 5-9}$$

2. With these rated currents, calculate the CT margin for windings 1 and 2:

$$I_{margin}[1] = \frac{CT_{primary}[1]}{I_{rated}[1]} = \frac{500 \text{ A}}{262.4 \text{ A}} = 1.91, \quad I_{margin}[2] = \frac{CT_{primary}[2]}{I_{rated}[2]} = \frac{1500 \text{ A}}{836.7 \text{ A}} = 1.79 \quad \text{Eq. 5-10}$$

3. Since  $I_{margin}[2] < I_{margin}[1]$ , the reference winding  $w_{ref}$  is winding 2.

The reference winding is shown in **ACTUAL VALUES** ⇒ **METERING** ⇒ **TRANSFORMER** ⇒ **DIFFERENTIAL AND RESTRAINT** ⇒ **REFERENCE WINDING**.

The unit for calculation of the differential and restraint currents and base for the differential restraint settings is the CT primary associated with the reference winding. In this example, the unit CT is 1500:5 on winding 2.

Magnitude compensation factors (M) are the scaling values by which each winding current is multiplied to refer it to the reference winding. The G30 calculates magnitude compensation factors for each winding as follows:

$$M[w] = \frac{I_{primary}[w] \times V_{nom}[w]}{I_{primary}[w_{ref}] \times V_{nom}[w_{ref}]}, \text{ where } w = 1, 2 \quad \text{Eq. 5-11}$$

In our example, the magnitude compensation factors are calculated as follows:

$$M[1] = \frac{I_{primary}[1] \times V_{nom}[1]}{I_{primary}[2] \times V_{nom}[2]} = \frac{500 \text{ A} \times 220 \text{ kV}}{1500 \text{ A} \times 69 \text{ kV}} = 1.0628 \quad \text{Eq. 5-12}$$

$$M[2] = \frac{I_{primary}[2] \times V_{nom}[2]}{I_{primary}[2] \times V_{nom}[2]} = \frac{1500 \text{ A} \times 69 \text{ kV}}{1500 \text{ A} \times 69 \text{ kV}} = 1.0000 \quad \text{Eq. 5-13}$$

The maximum allowed magnitude compensation factor (and hence the maximum allowed CT ratio mismatch) is 32.

### 5.5.4.6 Phase and zero sequence compensation

Power transformers can be connected to provide phase shift, such as the common  $\Delta$ -Y connection with its  $30^\circ$  phase shift. Historically, CT connections were arranged to compensate for this phase error so that the relaying operated correctly.

In our example, the transformer has the  $\Delta$ -Y connection. Traditionally, CTs on the Wye connected transformer winding (winding 2) are connected in a delta arrangement, which compensates for the phase angle lag introduced in the Delta connected winding (winding 1), so that line currents from both windings can be compared at the relay. The Delta connection of CTs, however, inherently has the effect of removing the zero sequence components of the phase currents. If

there is a grounding bank on the Delta winding of the power transformer within the zone of protection, a ground fault results in differential (zero sequence) current and false trips. In such a case, it is necessary to insert a zero sequence current trap with the Wye connected CTs on the Delta winding of the transformer.

In general, zero sequence removal is necessary if zero sequence can flow into and out of one transformer winding but not the other winding. Transformer windings that are grounded inside the zone of protection allow zero sequence current flow in that winding, and therefore it is from these windings that zero sequence removal is necessary.

The G30 performs this phase angle compensation and zero sequence removal automatically, based on the settings entered for the transformer. All CTs are connected Wye (polarity markings pointing away from the transformer). All currents are phase and zero sequence compensated internally before the calculation of differential and restraint quantities.

The phase reference winding ( $w_f$ ) is the winding to have a phase shift of  $0^\circ$  applied to it. The phase reference winding is chosen to be the delta or zigzag (non-wye) winding with the lowest winding index, if one exists. For a transformer that has no delta or zigzag windings, the first winding is chosen.

The phase compensation angle ( $\Phi_{comp}$ ), the angle by which a winding current is shifted to refer it to the phase reference winding, is calculated by the G30 for each winding as follows:

$$\Phi_{comp}[w] = | \Phi[w_f] - \Phi[w] | \text{ where Rotation} = \text{"ABC"} \quad \text{Eq. 5-14}$$

$$\Phi_{comp}[w] = | \Phi[w] - \Phi[w_f] | \text{ where Rotation} = \text{"ACB"} \quad \text{Eq. 5-15}$$

In our example, the phase reference winding is winding 1, the first delta winding (that is,  $w_f = 1$ ). The phase compensation angle for each winding is then calculated as follows (assuming Rotation = "ABC"):

$$\Phi_{comp}[1] = 0^\circ - 0^\circ = 0^\circ \quad \text{Eq. 5-16}$$

$$\Phi_{comp}[2] = 0^\circ - (-30^\circ) = 30^\circ = 330^\circ \text{ lag} \quad \text{Eq. 5-17}$$

The following table shows the linear combination of phases of a transformer winding that achieves the phase shift and zero sequence removal for typical values of  $\Phi_{comp}$

where

$I_A[w]$  = uncompensated winding 'w' phase A current

$I_A^P[w]$  = phase and zero sequence compensated winding 'w' phase A current

Table 5-19: Phase and zero sequence compensation for typical values of  $\Phi_{comp}$ 

$\Phi_{comp}[w]$	Grounding[w] = "Not within zone"	Grounding[w] = "Within zone"
0°	$I_A^P[w] = I_A[w]$ $I_B^P[w] = I_B[w]$ $I_C^P[w] = I_C[w]$	$I_A^P[w] = \frac{2}{3}I_A[w] - \frac{1}{3}I_B[w] - \frac{1}{3}I_C[w]$ $I_B^P[w] = \frac{2}{3}I_B[w] - \frac{1}{3}I_A[w] - \frac{1}{3}I_C[w]$ $I_C^P[w] = \frac{2}{3}I_C[w] - \frac{1}{3}I_A[w] - \frac{1}{3}I_B[w]$
30° lag	$I_A^P[w] = \frac{1}{\sqrt{3}}I_A[w] - \frac{1}{\sqrt{3}}I_C[w]$ $I_B^P[w] = \frac{1}{\sqrt{3}}I_B[w] - \frac{1}{\sqrt{3}}I_A[w]$ $I_C^P[w] = \frac{1}{\sqrt{3}}I_C[w] - \frac{1}{\sqrt{3}}I_B[w]$	$I_A^P[w] = \frac{1}{\sqrt{3}}I_A[w] - \frac{1}{\sqrt{3}}I_C[w]$ $I_B^P[w] = \frac{1}{\sqrt{3}}I_B[w] - \frac{1}{\sqrt{3}}I_A[w]$ $I_C^P[w] = \frac{1}{\sqrt{3}}I_C[w] - \frac{1}{\sqrt{3}}I_B[w]$
60° lag	$I_A^P[w] = -I_C[w]$ $I_B^P[w] = -I_A[w]$ $I_C^P[w] = -I_B[w]$	$I_A^P[w] = -\frac{2}{3}I_C[w] + \frac{1}{3}I_A[w] + \frac{1}{3}I_B[w]$ $I_B^P[w] = -\frac{2}{3}I_A[w] + \frac{1}{3}I_B[w] + \frac{1}{3}I_C[w]$ $I_C^P[w] = -\frac{2}{3}I_B[w] + \frac{1}{3}I_A[w] + \frac{1}{3}I_C[w]$
90° lag	$I_A^P[w] = \frac{1}{\sqrt{3}}I_B[w] - \frac{1}{\sqrt{3}}I_C[w]$ $I_B^P[w] = \frac{1}{\sqrt{3}}I_C[w] - \frac{1}{\sqrt{3}}I_A[w]$ $I_C^P[w] = \frac{1}{\sqrt{3}}I_A[w] - \frac{1}{\sqrt{3}}I_B[w]$	$I_A^P[w] = \frac{1}{\sqrt{3}}I_B[w] - \frac{1}{\sqrt{3}}I_C[w]$ $I_B^P[w] = \frac{1}{\sqrt{3}}I_C[w] - \frac{1}{\sqrt{3}}I_A[w]$ $I_C^P[w] = \frac{1}{\sqrt{3}}I_A[w] - \frac{1}{\sqrt{3}}I_B[w]$
120° lag	$I_A^P[w] = I_B[w]$ $I_B^P[w] = I_C[w]$ $I_C^P[w] = I_A[w]$	$I_A^P[w] = \frac{2}{3}I_B[w] - \frac{1}{3}I_A[w] - \frac{1}{3}I_C[w]$ $I_B^P[w] = \frac{2}{3}I_C[w] - \frac{1}{3}I_A[w] - \frac{1}{3}I_B[w]$ $I_C^P[w] = \frac{2}{3}I_A[w] - \frac{1}{3}I_B[w] - \frac{1}{3}I_C[w]$
150° lag	$I_A^P[w] = \frac{1}{\sqrt{3}}I_B[w] - \frac{1}{\sqrt{3}}I_A[w]$ $I_B^P[w] = \frac{1}{\sqrt{3}}I_C[w] - \frac{1}{\sqrt{3}}I_B[w]$ $I_C^P[w] = \frac{1}{\sqrt{3}}I_A[w] - \frac{1}{\sqrt{3}}I_C[w]$	$I_A^P[w] = \frac{1}{\sqrt{3}}I_B[w] - \frac{1}{\sqrt{3}}I_A[w]$ $I_B^P[w] = \frac{1}{\sqrt{3}}I_C[w] - \frac{1}{\sqrt{3}}I_B[w]$ $I_C^P[w] = \frac{1}{\sqrt{3}}I_A[w] - \frac{1}{\sqrt{3}}I_C[w]$
180° lag	$I_A^P[w] = -I_A[w]$ $I_B^P[w] = -I_B[w]$ $I_C^P[w] = -I_C[w]$	$I_A^P[w] = -\frac{2}{3}I_A[w] + \frac{1}{3}I_B[w] + \frac{1}{3}I_C[w]$ $I_B^P[w] = -\frac{2}{3}I_B[w] + \frac{1}{3}I_A[w] + \frac{1}{3}I_C[w]$ $I_C^P[w] = -\frac{2}{3}I_C[w] + \frac{1}{3}I_A[w] + \frac{1}{3}I_B[w]$
210° lag	$I_A^P[w] = \frac{1}{\sqrt{3}}I_C[w] - \frac{1}{\sqrt{3}}I_A[w]$ $I_B^P[w] = \frac{1}{\sqrt{3}}I_A[w] - \frac{1}{\sqrt{3}}I_B[w]$ $I_C^P[w] = \frac{1}{\sqrt{3}}I_B[w] - \frac{1}{\sqrt{3}}I_C[w]$	$I_A^P[w] = \frac{1}{\sqrt{3}}I_C[w] - \frac{1}{\sqrt{3}}I_A[w]$ $I_B^P[w] = \frac{1}{\sqrt{3}}I_A[w] - \frac{1}{\sqrt{3}}I_B[w]$ $I_C^P[w] = \frac{1}{\sqrt{3}}I_B[w] - \frac{1}{\sqrt{3}}I_C[w]$

$\Phi_{comp}[w]$	<u>Grounding[w] = "Not within zone"</u>	<u>Grounding[w] = "Within zone"</u>
240° lag	$I_A^P[w] = I_C[w]$ $I_B^P[w] = I_A[w]$ $I_C^P[w] = I_B[w]$	$I_A^P[w] = \frac{2}{3}I_C[w] - \frac{1}{3}I_A[w] - \frac{1}{3}I_B[w]$ $I_B^P[w] = \frac{2}{3}I_A[w] - \frac{1}{3}I_B[w] - \frac{1}{3}I_C[w]$ $I_C^P[w] = \frac{2}{3}I_B[w] - \frac{1}{3}I_A[w] - \frac{1}{3}I_C[w]$
270° lag	$I_A^P[w] = \frac{1}{\sqrt{3}}I_C[w] - \frac{1}{\sqrt{3}}I_B[w]$ $I_B^P[w] = \frac{1}{\sqrt{3}}I_A[w] - \frac{1}{\sqrt{3}}I_C[w]$ $I_C^P[w] = \frac{1}{\sqrt{3}}I_B[w] - \frac{1}{\sqrt{3}}I_A[w]$	$I_A^P[w] = \frac{1}{\sqrt{3}}I_C[w] - \frac{1}{\sqrt{3}}I_B[w]$ $I_B^P[w] = \frac{1}{\sqrt{3}}I_A[w] - \frac{1}{\sqrt{3}}I_C[w]$ $I_C^P[w] = \frac{1}{\sqrt{3}}I_B[w] - \frac{1}{\sqrt{3}}I_A[w]$
300° lag	$I_A^P[w] = -I_B[w]$ $I_B^P[w] = -I_C[w]$ $I_C^P[w] = -I_A[w]$	$I_A^P[w] = -\frac{2}{3}I_B[w] + \frac{1}{3}I_A[w] + \frac{1}{3}I_C[w]$ $I_B^P[w] = -\frac{2}{3}I_C[w] + \frac{1}{3}I_A[w] + \frac{1}{3}I_B[w]$ $I_C^P[w] = -\frac{2}{3}I_A[w] + \frac{1}{3}I_B[w] + \frac{1}{3}I_C[w]$
330° lag	$I_A^P[w] = \frac{1}{\sqrt{3}}I_A[w] - \frac{1}{\sqrt{3}}I_B[w]$ $I_B^P[w] = \frac{1}{\sqrt{3}}I_B[w] - \frac{1}{\sqrt{3}}I_C[w]$ $I_C^P[w] = \frac{1}{\sqrt{3}}I_C[w] - \frac{1}{\sqrt{3}}I_A[w]$	$I_A^P[w] = \frac{1}{\sqrt{3}}I_A[w] - \frac{1}{\sqrt{3}}I_B[w]$ $I_B^P[w] = \frac{1}{\sqrt{3}}I_B[w] - \frac{1}{\sqrt{3}}I_C[w]$ $I_C^P[w] = \frac{1}{\sqrt{3}}I_C[w] - \frac{1}{\sqrt{3}}I_A[w]$

In our example, the following phase and zero-sequence compensation equations would be used:

For Winding 1:

$$I_A^P[1] = \frac{2}{3}I_A[1] - \frac{1}{3}I_B[1] - \frac{1}{3}I_C[1]; \quad I_B^P[1] = \frac{2}{3}I_B[1] - \frac{1}{3}I_A[1] - \frac{1}{3}I_C[1]; \quad I_C^P[1] = \frac{2}{3}I_C[1] - \frac{1}{3}I_A[1] - \frac{1}{3}I_B[1] \quad \text{Eq. 5-18}$$

For Winding 2:

$$I_A^P[w] = \frac{1}{\sqrt{3}}I_A[2] - \frac{1}{\sqrt{3}}I_B[2]; \quad I_B^P[w] = \frac{1}{\sqrt{3}}I_B[2] - \frac{1}{\sqrt{3}}I_C[2]; \quad I_C^P[w] = \frac{1}{\sqrt{3}}I_C[2] - \frac{1}{\sqrt{3}}I_A[2] \quad \text{Eq. 5-19}$$

### 5.5.4.7 Magnitude, phase, angle, and zero-sequence compensation calculations

Complete magnitude, phase angle, and zero sequence compensation is as follows:

$$I_A^C[w] = M[w] \times I_A^P[w], \text{ where } w = 1, 2 \quad \text{Eq. 5-20}$$

$$I_B^C[w] = M[w] \times I_B^P[w], \text{ where } w = 1, 2 \quad \text{Eq. 5-21}$$

$$I_C^C[w] = M[w] \times I_C^P[w], \text{ where } w = 1, 2 \quad \text{Eq. 5-22}$$

where

$I_A^C[w]$ ,  $I_B^C[w]$ , and  $I_C^C[w]$  = magnitude, phase, and zero-sequence compensated winding w phase currents

$M[w]$  = magnitude compensation factor for winding w (see previous sections)

$I_A^P[w]$ ,  $I_B^P[w]$ , and  $I_C^P[w]$  = phase and zero sequence compensated winding w phase currents (see earlier)



### 5.5.4.8 Differential and restraint current calculations

Differential and restraint currents are calculated as follows:

$$I_{dA} = I_A^C[1] + I_A^C[2] \tag{Eq. 5-23}$$

$$I_{dB} = I_B^C[1] + I_B^C[2] \tag{Eq. 5-24}$$

$$I_{dC} = I_C^C[1] + I_C^C[2] \tag{Eq. 5-25}$$

$$I_{rA} = \max (|I_A^C[1]|, |I_A^C[2]|) \tag{Eq. 5-26}$$

$$I_{rB} = \max (|I_B^C[1]|, |I_B^C[2]|) \tag{Eq. 5-27}$$

$$I_{rC} = \max (|I_C^C[1]|, |I_C^C[2]|) \tag{Eq. 5-28}$$

where

$I_{dA}$ ,  $I_{dB}$ , and  $I_{dC}$  are the phase differential currents

$I_{rA}$ ,  $I_{rB}$ , and  $I_{rC}$  are the phase restraint currents

### 5.5.4.9 Transformer thermal inputs

SETTINGS ⇒ SYSTEM SETUP ⇒ TRANSFORMER ⇒ THERMAL INPUTS

<div style="border: 1px solid black; padding: 5px;"> <p>■ THERMAL INPUTS</p> <p>■</p> </div>	↔	<p><b>WINDING CURRENTS:</b> SRC 1</p>	Range: SRC 1, SRC 2, SRC 3, SRC 4 (or the user-defined name)
	↕	<p><b>AMBIENT TEMPERATURE:</b> RTD Input 1</p>	Range: RTD Input 1, RTD Input 2,..., RTD Input 8, dcmA Input 1, dcmA Input 2,..., dcmA Input 8, RRTD 1, RRTD2,..., RRTD 12, Monthly Average
	↑	<p><b>TOP-OIL TEMPERATURE:</b> RTD Input 1</p>	Range: RTD Input 1, RTD Input 2,..., RTD Input 8, dcmA Input 1, dcmA Input 2,..., dcmA Input 8, RRTD 1, RRTD2,..., RRTD 12, Monthly Average



The thermal inputs settings are used for computation of hottest-spot winding temperature, aging factor, and accumulated loss of life.

**WINDING CURRENTS** — Enter a source that represents the true winding load currents.

In cases where two or more sets of CTs are associated to the winding and where thermal elements are to be set (for example, in a breaker-and-a-half scheme), use a spare source for current summation from these CTs to obtain the total true winding current. Otherwise, select the only source representing the other winding current.

**AMBIENT TEMPERATURE** — Select an RTD, DCmA, or remote RTD input if the ambient temperature is to be measured directly. Otherwise, select “Monthly Average” and enter an average temperature for each month of the year if a directly measured device output is not available (see the monthly settings that follow).

**TOP OIL TEMPERATURE** — Select RTD, DCmA, or remote RTD input for direct measurement of top-oil temperature. If an RTD or DCmA input is not available, select “Computed.”

The following menu displays when **AMBIENT TEMPERATURE** is “Monthly Average.”

SETTINGS ⇒ SYSTEM SETUP ⇒ TRANSFORMER ⇒ THERMAL INPUTS ⇒ AMBIENT TEMPERATURE

<div style="border: 1px solid black; padding: 5px;"> <p><b>AMBIENT TEMPERATURE:</b> Monthly Average</p> </div>	↔	<p><b>JANUARY AVERAGE:</b> -20°C</p>	Range: -60 to 60°C in steps of 1
	↕	<p><b>FEBRUARY AVERAGE:</b> -30°C</p>	Range: -60 to 60°C in steps of 1
	↕	<p><b>MARCH AVERAGE:</b> -10°C</p>	Range: -60 to 60°C in steps of 1
	↓	<p><b>DECEMBER AVERAGE:</b> -10°C</p>	Range: -60 to 60°C in steps of 1

### 5.5.5 Breakers

SETTINGS ⇒ SYSTEM SETUP ⇒ BREAKERS ⇒ BREAKER 1(2)

■ BREAKER 1	↔	BREAKER 1 FUNCTION: Disabled	Range: Disabled, Enabled
	↕	BREAKER1 PUSH BUTTON CONTROL: Disabled	Range: Disabled, Enabled
	↕	BREAKER 1 TAGGING: Disabled	Range: Disabled, Enabled
	↕	BREAKER 1 SUBSTITUTN: Disabled	Range: Disabled, Enabled
	↕	BREAKER 1 BYPASS: Disabled	Range: Disabled, Enabled
	↕	BREAKER 1 NAME: Bkr 1	Range: up to six alphanumeric characters
	↕	BREAKER 1 MODE: 3-Pole	Range: 3-Pole, 1-Pole
	↕	BREAKER 1 OPEN: Off	Range: FlexLogic operand
	↕	BREAKER 1 BLK OPEN: Off	Range: FlexLogic operand
	↕	BREAKER 1 CLOSE: Off	Range: FlexLogic operand
	↕	BREAKER 1 BLK CLOSE: Off	Range: FlexLogic operand
	↕	BREAKER1 $\Phi$ A/3P CLSD: Off	Range: FlexLogic operand
	↕	BREAKER1 $\Phi$ A/3P OPND: Off	Range: FlexLogic operand
	↕	BREAKER 1 $\Phi$ B CLOSED: Off	Range: FlexLogic operand
	↕	BREAKER 1 $\Phi$ B OPENED: Off	Range: FlexLogic operand
	↕	BREAKER 1 $\Phi$ C CLOSED: Off	Range: FlexLogic operand
	↕	BREAKER 1 $\Phi$ C OPENED: Off	Range: FlexLogic operand
	↕	BREAKER 1 TOPERATE: 70 ms	Range: 0 to 65535 s in steps of 1
	↕	BREAKER 1 EXT ALARM: Off	Range: FlexLogic operand
	↕	BREAKER 1 ALARM DELAY: 0.000 s	Range: 0.000 to 65.535 s in steps of 0.001
	↕	MANUAL CLOSE RECAL1 TIME: 0.000 s	Range: 0.000 to 65.535 s in steps of 0.001
	↕	BREAKER 1 OPEN SEAL-IN: 0.000 s	Range: 0.000 to 65.535 s in steps of 0.001
	↕	BREAKER 1 OUT OF SV: Off	Range: FlexLogic operand

↕	<b>BREAKER 1 RACKED-IN:</b> Off	Range: FlexLogic operand
↑	<b>BREAKER 1 EVENTS:</b> Disabled	Range: Disabled, Enabled

The breaker control element contains the auxiliary logic for status and serves as the interface for opening and closing of a circuit breaker from protection, autoreclose, SCADA, or through the front panel interface. The breaker control element can be used to create interlocking functionality. For greater security in determination of the breaker position, both the 52/a and 52/b auxiliary contacts are used with reporting of the discrepancy between them.

To use this element, configure the contact outputs that trip and close the breaker to use FlexLogic operands **BREAKER 1 OFF CMD** (or **BREAKER 1 TRIP A/B/C** in the case of single-pole tripping) and **BREAKER 1 ON CMD**, and configure the breaker control element inputs as described here.

A description of the operation of the breaker control and status monitoring features from the front panel is provided in chapter 4.

There are two breaker control elements for each CT/VT module installed. The following settings are available for each breaker control element.

**BREAKER 1 FUNCTION** — This setting enables and disables the operation of the breaker 1 control feature.

**BREAKER1 PUSH BUTTON CONTROL** — Set to "Enable" to allow front panel pushbutton open/close control operations.

**BREAKER1 TAGGING** — Set to "Enable" to allow the graphical front panel to tag breaker 1. When tagged, the following operations are disabled: pushbutton open/close, IEC 61850 open/close, and close command initiated by **BREAKER 1 CLOSE** setting. The trip command issued by the Trip Out element or **BREAKER 1 OPEN** setting is not affected.

**BREAKER1 SUBSTITUTN** — Set to "Enable" to allow the graphical front panel to substitute breaker 1 status. When substituted, breaker 1 control open/close status is forced to the substituted value.

**BREAKER1 BYPASS** — Set to "Enable" to allow the graphical front panel to bypass breaker 1 interlocking. When asserted, **BREAKER 1 BLK OPEN** and **BREAKER 1 BLK CLOSE** settings are bypassed.

**BREAKER 1 NAME** — Assign a user-defined name (up to six characters) to the breaker. This name is used in flash messages related to breaker 1.

**BREAKER 1 MODE** — Selects "3-Pole" mode, where all breaker poles are operated simultaneously, or "1-Pole" mode where all breaker poles are operated either independently or simultaneously.

**BREAKER 1 OPEN** — Selects an operand that when activated, and unless blocked, initiates the Breaker 1 open and individual phase trip commands.

**BREAKER 1 BLK OPEN** — Selects an operand that prevents initiation of Breaker 1 open and individual phase trip commands. This setting can be used for blocking circuit breaker tripping for instance when breaker monitoring detects conditions such as low SF<sub>6</sub> gas density during which breaker opening can cause damage.

**BREAKER 1 CLOSE** — Selects an operand that when activated, and unless blocked, initiates the Breaker 1 close commands.

**BREAKER 1 BLK CLOSE** — Selects an operand that prevents initiation of Breaker 1 close commands. This setting can be used for blocking circuit breaker closing, for instance to prevent closing into a closed ground switch.

**BREAKER1  $\Phi$ A/3P CLSD** — Selects an operand, usually a contact input connected to a breaker auxiliary position tracking mechanism. This input is for a normally-open 52/a status input that creates a logic 1 when the breaker is closed. If the **BREAKER 1 MODE** setting is selected as "3-Pole," this setting selects a single 52/a input as the operand used to track the breaker open or closed position. If the mode is selected as "1-Pole," the input mentioned is used to track phase A and the **BREAKER 1  $\Phi$ B** and **BREAKER 1  $\Phi$ C** settings select operands to track phases B and C, respectively.

**BREAKER1  $\Phi$ A/3P OPND** — Selects an operand, usually a contact input, that is for a normally-closed 52/b status input that creates a logic 1 when the breaker is open. If a separate 52/b contact input is not available, then the inverted 52/a status signal or the inverted **BREAKER 1 CLOSED** status signal can be used.

**BREAKER 1  $\Phi$ B CLOSED** — If the mode is selected as three-pole, this setting has no function. If the mode is selected as single-pole, this input is used to track the breaker phase B closed position as outlined for phase A.

**BREAKER 1  $\Phi$ B OPENED** — If the mode is selected as three-pole, this setting has no function. If the mode is selected as single-pole, this input is used to track the breaker phase B opened position as outlined for phase A.

**BREAKER 1  $\Phi$ C CLOSED** — If the mode is selected as three-pole, this setting has no function. If the mode is selected as single-pole, this input is used to track the breaker phase C closed position as outlined for phase A.

**BREAKER 1  $\Phi$ C OPENED** — If the mode is selected as three-pole, this setting has no function. If the mode is selected as single-pole, this input is used to track the breaker phase C opened position as outlined for phase A.

**BREAKER 1 TOPERATE** — This setting specifies the required interval to overcome transient disagreement between the 52/a and 52/b auxiliary contacts during breaker operation. If transient disagreement still exists after this time has expired, the **BREAKER 1 BAD STATUS** FlexLogic operand is asserted for alarm or blocking purposes.

**BREAKER 1 EXT ALARM** — This setting selects an operand, usually an external contact input connected to a breaker alarm reporting contact. While the selected operand is active, the **BREAKER 1 TROUBLE** operand is activated.

**BREAKER 1 ALARM DELAY** — This setting specifies the delay interval during which a disagreement of status among the three-pole position tracking operands does not declare a pole disagreement. This allows for non-simultaneous operation of the poles.

**BREAKER 1 OPEN SEAL-IN** — This setting specifies the seal-in time of the three-pole open command initiated by either the Trip Out element or a manual open command to the circuit breaker.

**MANUAL CLOSE RECAL1 TIME** — This setting specifies the seal-in time of the close commands due to an operator-initiated manual close command to the circuit breaker.

**BREAKER 1 OUT OF SV** — Selects an operand indicating that breaker 1 is out-of-service.

**BREAKER 1 RACKED-IN** — This setting selects a contact input to show whether the breaker is racked-in or racked-out. The racked-in or racked-out status is used to indicate dynamically the status of breaker symbol, only applied in the single-line diagram in the graphical front panel. If this setting is set to Off, the racked status is not considered.

Figure 5-72: Dual breaker control logic (Sheet 1 of 3)

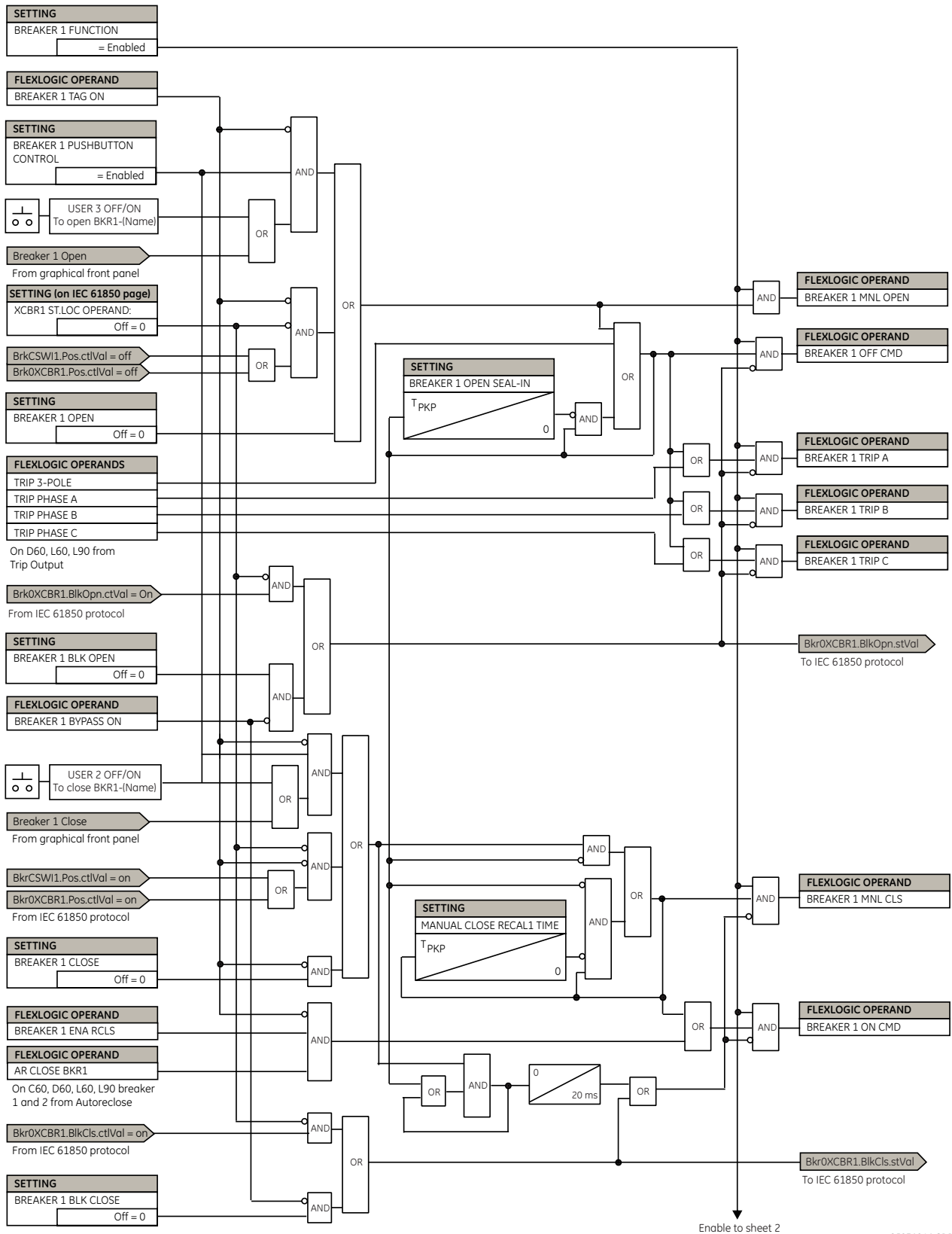
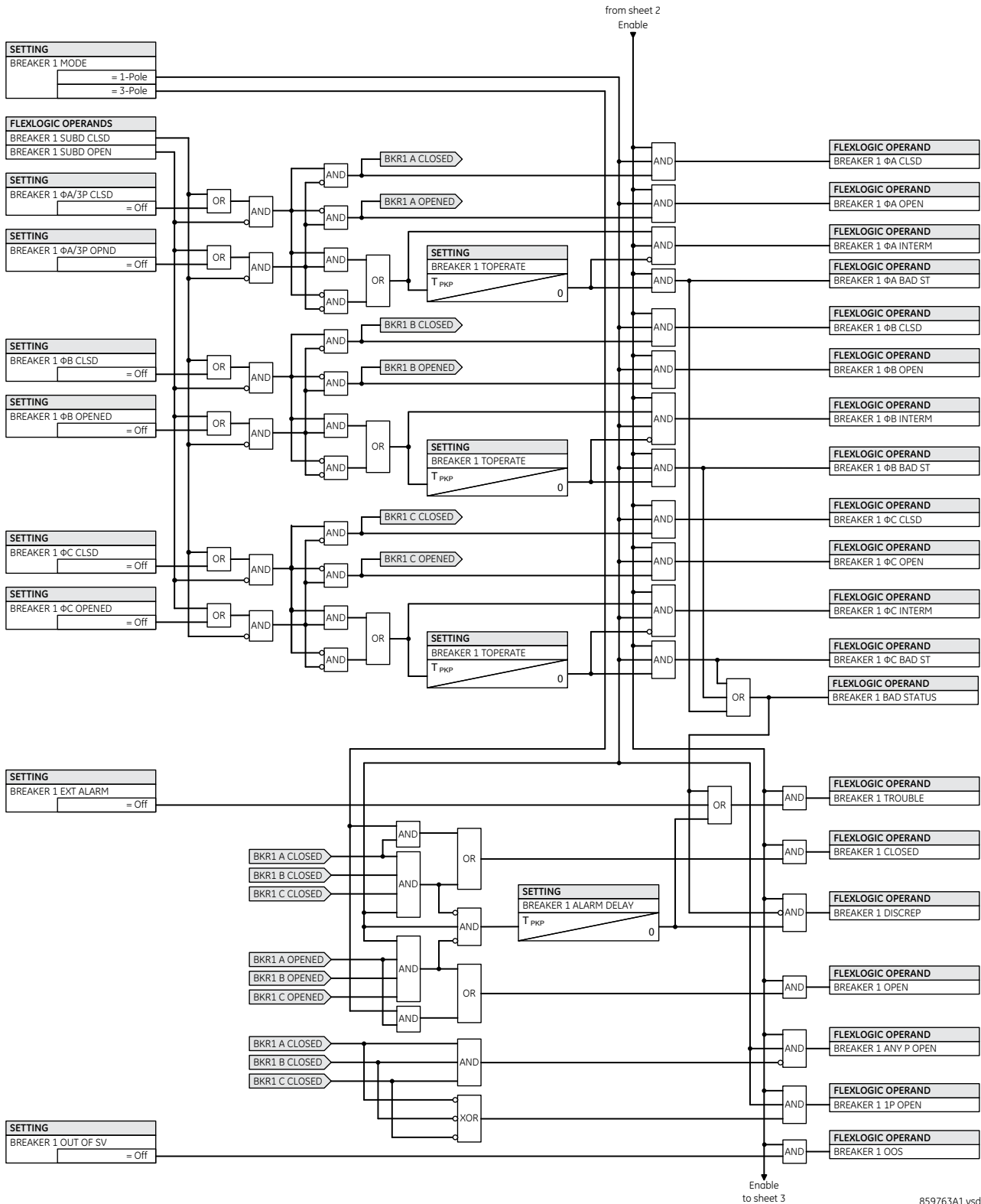
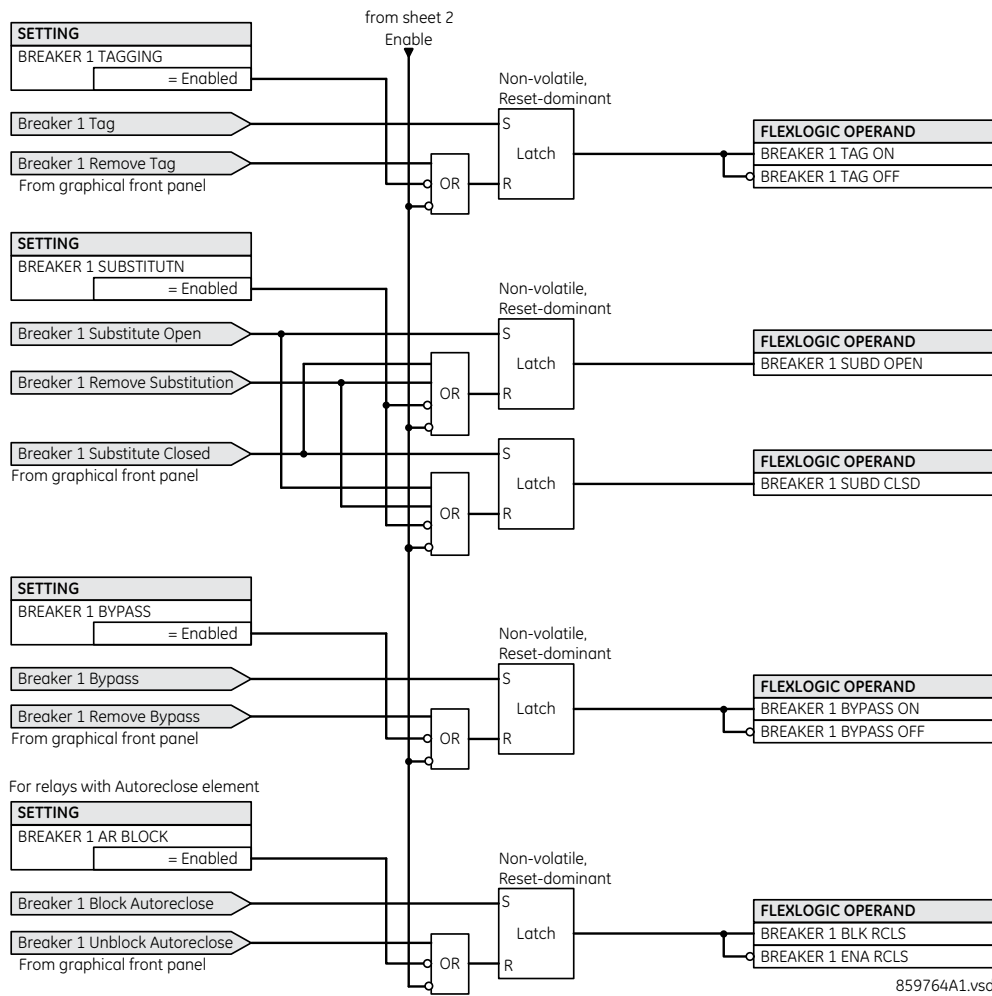


Figure 5-73: Dual breaker control logic (Sheet 2 of 3)



5

Figure 5-74: Dual breaker / graphical front panel control logic (Sheet 3 of 3)



The breaker element has direct hard-coded connections to the IEC 61850 model as shown in the logic diagram. This allows remote open/close operation of each breaker, using either CSWI or XCBR IEC 61850 logical nodes. IEC 61850 select-before-operate functionality, local/remote switch functionality, along with blocking of open/close commands are provided. Note that the dwell time for the IEC 61850 trip and close commands shown is one protection pass only. To maintain the close/open command for a certain time, do so by setting the seal-in timers **BREAKER 1 OPEN SEAL-IN** and **MANUAL CLOSE RECAL1 TIME**, on the contact outputs using the "Seal-in" setting, in the Trip Output element, and/or in FlexLogic.

### 5.5.6 Disconnect switch control

SETTINGS ⇄ SYSTEM SETUP ⇄ SWITCHES ⇄ SWITCH 1(8)

<div style="border: 1px solid black; padding: 2px;"> <span style="display: inline-block; width: 10px; height: 10px; background-color: black; margin-right: 5px;"></span> SWITCH 1         </div>	⇄	<div style="border: 1px solid black; padding: 2px;">           SWITCH 1            FUNCTION: Disabled         </div>	Range: Disabled, Enabled
	⇄	<div style="border: 1px solid black; padding: 2px;">           SWITCH 1 NAME:            SW 1         </div>	Range: up to six alphanumeric characters
	⇄	<div style="border: 1px solid black; padding: 2px;">           SWITCH 1 MODE:            3-Pole         </div>	Range: 3-Pole, 1-Pole
	⇄	<div style="border: 1px solid black; padding: 2px;">           SWITCH 1 OPEN:            Off         </div>	Range: FlexLogic operand

⇅	SWITCH 1 BLK OPEN: Off	Range: FlexLogic operand
⇅	SWITCH 1 CLOSE: Off	Range: FlexLogic operand
⇅	SWITCH 1 BLK CLOSE: Off	Range: FlexLogic operand
⇅	SWITCH 1 $\Phi$ A/3P CLSD: Off	Range: FlexLogic operand
⇅	SWITCH 1 $\Phi$ A/3P OPND: Off	Range: FlexLogic operand
⇅	SWITCH 1 $\Phi$ B CLOSED: Off	Range: FlexLogic operand
⇅	SWITCH 1 $\Phi$ B OPENED: Off	Range: FlexLogic operand
⇅	SWITCH 1 $\Phi$ C CLOSED: Off	Range: FlexLogic operand
⇅	SWITCH 1 $\Phi$ C OPENED: Off	Range: FlexLogic operand
⇅	SWITCH1 PUSH BUTTON CONTROL: Disabled	Range: Disabled, Enabled
⇅	SWITCH 1 TAGGING: Disabled	Range: Disabled, Enabled
⇅	SWITCH 1 SUBSTITUTN: Disabled	Range: Disabled, Enabled
⇅	SWITCH 1 BYPASS: Disabled	Range: Disabled, Enabled
⇅	SWITCH 1 OPEN SEAL-IN: 0.000 s	Range: 0.000 to 65.535 s in steps of 0.001
⇅	SWITCH 1 CLOSE SEAL-IN: 0.000 s	Range: 0.000 to 65.535 s in steps of 0.001
⇅	SWITCH 1 TOPERATE: 70 ms	Range: 0 to 65535 ms in steps of 1
⇅	SWITCH 1 ALARM DELAY: 0.000 s	Range: 0.000 to 65.535 s in steps of 0.001
⇅	SWITCH 1 EVENTS: Disabled	Range: Disabled, Enabled

The disconnect switch control element contains the auxiliary logic for status and serves as the interface for opening and closing of disconnect switches from SCADA or through the front panel interface. The disconnect switch control element can be used to create interlocking functionality. For greater security in determination of the switch pole position, both the 89/a and 89/b auxiliary contacts are used with reporting of the discrepancy between them. There are eight disconnect switch control elements for each CT/VT module installed.

To use this element, configure the contact outputs that open and close the disconnect switch to use FlexLogic operands [SWITCH 1 OFF CMD](#) and [SWITCH 1 ON CMD](#), and configure the disconnect switch control element's inputs as outlined here.

**SWITCH 1 FUNCTION** — This setting enables and disables operation of the disconnect switch element.

**SWITCH 1 NAME** — Assign a user-defined name (up to six characters) to the disconnect switch. This name is used in flash messages related to disconnect switch 1.

**SWITCH 1 MODE** — This setting selects “3-Pole” mode, where disconnect switch poles have a single common auxiliary switch, or “1-Pole” mode where each disconnect switch pole has its own auxiliary switch.



**SWITCH 1 OPEN** — This setting selects an operand that when activated, and unless blocked, initiates the disconnect switch 1 open command.

**SWITCH 1 BLK OPEN** — This setting selects an operand that prevents initiation of the disconnect switch 1 command. This setting can be used to block the disconnect switch from opening, for instance when switchyard monitoring indicates that current exceeding the switch's interrupting rating can be flowing through the switch.

**SWITCH 1 CLOSE** — This setting selects an operand that when activated, and unless blocked, initiates the disconnect switch 1 close command.

**SWITCH 1 BLK CLOSE** — This setting selects an operand that prevents initiation of disconnect switch 1 close commands. This setting can be used to block the disconnect switch from closing, for instance to prevent closing into a closed ground switch.

**SWITCH 1  $\Phi$ A/3P CLSD** — This setting selects an operand, usually a contact input connected to a disconnect switch auxiliary position tracking mechanism. This input is for a normally-open 89/a status input that creates a logic 1 when the disconnect switch is closed. If the **SWITCH 1 MODE** setting is selected as "3-Pole," this setting selects a single 89/a input as the operand used to track the disconnect switch open or closed position. If the mode is selected as "1-Pole," the input mentioned is used to track phase A and the **SWITCH 1  $\Phi$ B** and **SWITCH 1  $\Phi$ C** settings select operands to track phases B and C, respectively.

**SWITCH 1  $\Phi$ A/3P OPND** — This setting selects an operand, usually a contact input, that is for a normally-closed 89/b status input that creates a logic 1 when the disconnect switch is open. If a separate 89/b contact input is not available, then an inverted 89/a status signal can be used.

**SWITCH 1  $\Phi$ B CLOSED** — If the mode is selected as three-pole, this setting has no function. If the mode is selected as single-pole, this input is used to track the disconnect switch phase B closed position as outlined for phase A.

**SWITCH 1  $\Phi$ B OPENED** — If the mode is selected as three-pole, this setting has no function. If the mode is selected as single-pole, this input is used to track the disconnect switch phase B opened position as outlined for phase A.

**SWITCH 1  $\Phi$ C CLOSED** — If the mode is selected as three-pole, this setting has no function. If the mode is selected as single-pole, this input is used to track the disconnect switch phase C closed position as outlined for phase A.

**SWITCH 1  $\Phi$ C OPENED** — If the mode is selected as three-pole, this setting has no function. If the mode is selected as single-pole, this input is used to track the disconnect switch phase C opened position as outlined for phase A.

**SWITCH 1 PUSH BUTTON CONTROL** — Set to "Enable" to allow front panel pushbutton open/close control operations.

**SWITCH 1 TAGGING** — Set to "Enable" to allow the graphical front panel to tag switch 1. When tagged, the following operations are disabled:

- Pushbutton Open/Close
- IEC 61850 Open/Close
- Open command initiated by **SWITCH 1 OPEN** setting
- Close command initiated by **SWITCH 1 CLOSE** setting

**SWITCH 1 SUBSTITUTN** — Set to "Enable" to allow the graphical front panel to substitute switch 1 status. When substituted, switch 1 control open/close status is forced to the substituted value.

**SWITCH 1 BYPASS** — Set to "Enable" to allow the graphical front panel to bypass switch 1 interlocking. When asserted, **SWITCH 1 BLK OPEN** and **SWITCH 1 BLK CLOSE** settings are bypassed.

**SWITCH 1 OPEN SEAL-IN** — This setting specifies the seal-in time of the open command due to an operator-initiated manual open command to the disconnect switch.

**SWITCH 1 CLOSE SEAL-IN** — This setting specifies the seal-in time of the close command due to an operator-initiated manual close command to the disconnect switch.

**SWITCH 1 TOPERATE** — This setting specifies the required interval to overcome transient disagreement between the 89/a and 89/b auxiliary contacts during disconnect switch operation. If transient disagreement still exists after this time has expired, the **SWITCH 1 BAD STATUS** FlexLogic operand is asserted for alarm or blocking purposes.

**SWITCH 1 ALARM DELAY** — This setting specifies the delay interval during which a disagreement of status among the pole position tracking operands do not declare a pole disagreement. This allows for non-simultaneous operation of the poles.



IEC 61850 functionality is permitted when the G30 is in "Programmed" mode and not in local control mode.

The switch element has direct hard-coded connections to the IEC 61850 model as shown in the logic diagrams. This allows remote open/close operation of each switch, using either CSWI or XSWI IEC 61850 logical nodes. IEC 61850 select-before-operate functionality, local/remote switch functionality, along with blocking open/close commands are provided. Note that the dwell time for the IEC 61850 trip and close commands shown is one protection pass only. To maintain close/open command for a certain time, do so using the seal-in timers **SWITCH 1 OPEN SEAL-IN** and **SWITCH 1 CLOSE SEAL-IN**, on the contact outputs using the "Seal-in" setting, or in FlexLogic.

Figure 5-75: Disconnect switch control logic (sheet 1 of 3)

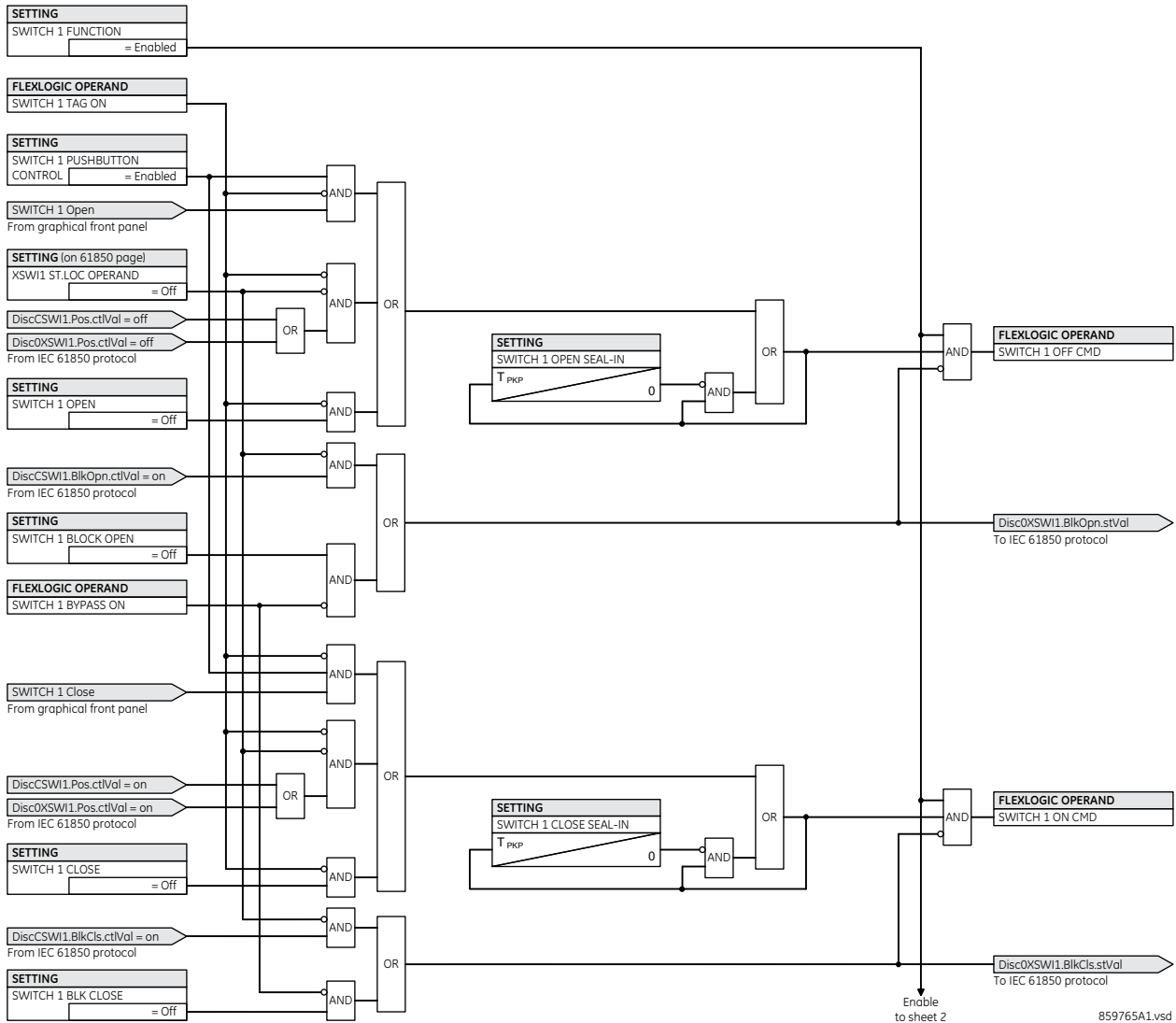


Figure 5-76: Disconnect switch control status logic (sheet 2 of 3)

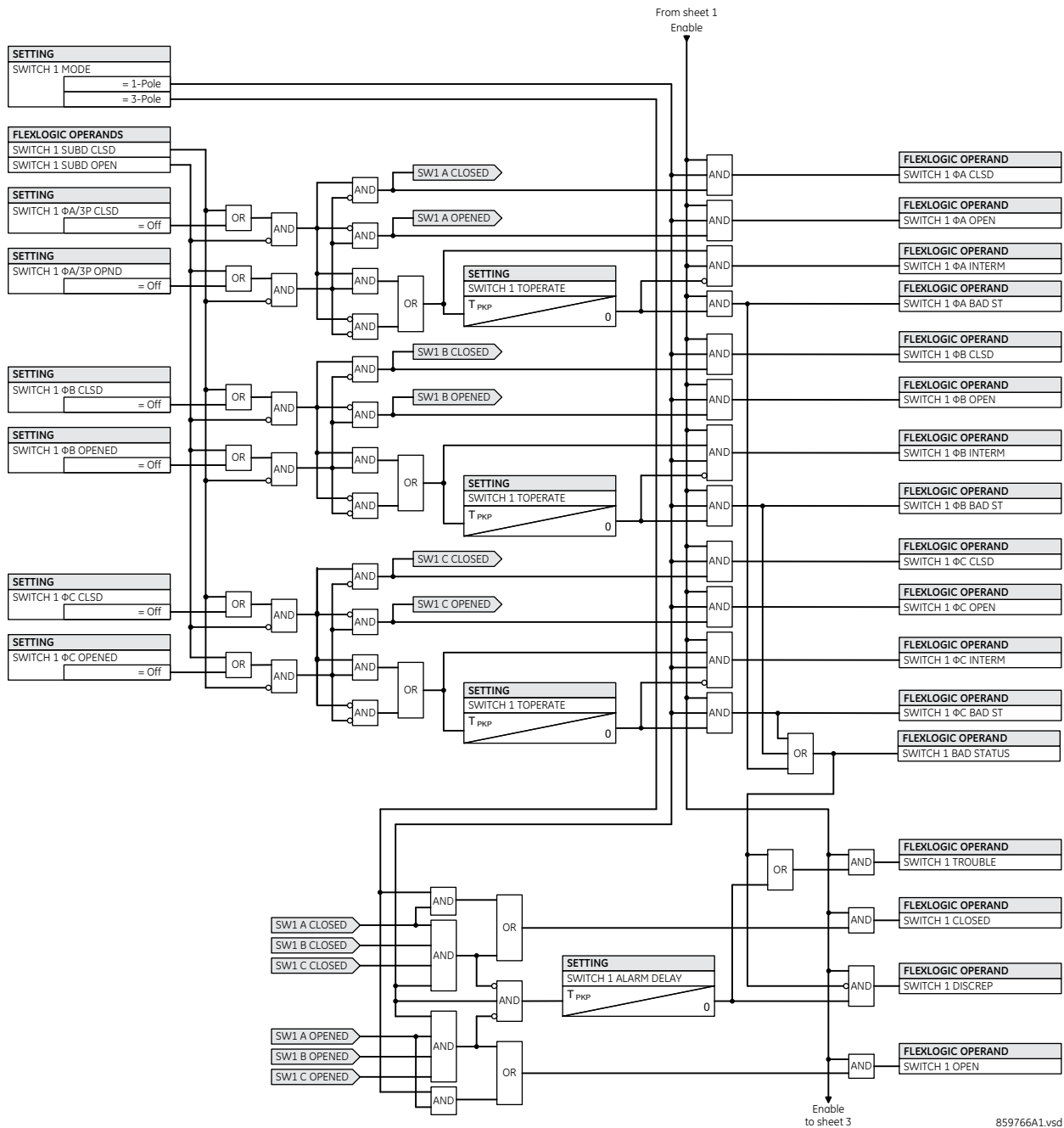
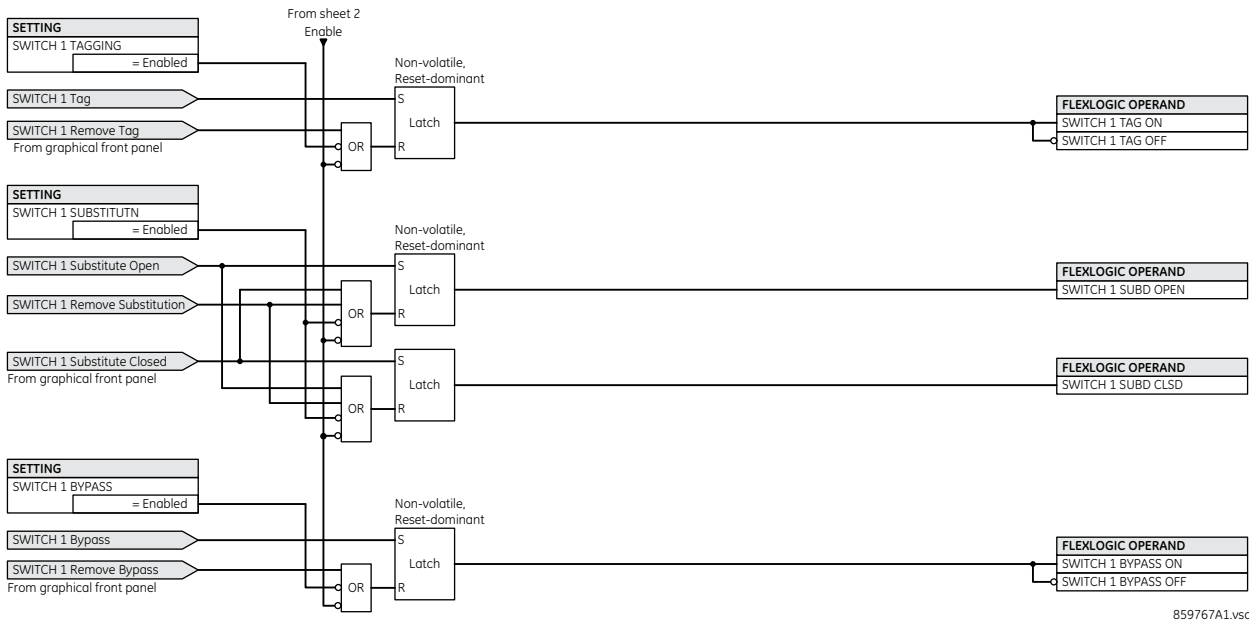


Figure 5-77: Disconnect switch control graphical front panel logic (sheet 3 of 3)



859767A1.vsd

5

### 5.5.7 FlexCurves

#### 5.5.7.1 Settings

SETTINGS ⇨ SYSTEM SETUP ⇨ FLEXCURVES ⇨ FLEXCURE A(D)

<input checked="" type="checkbox"/> FLEXCURVE A <input type="checkbox"/>	↔	FLEXCURVE A TIME AT 0.00 xPKP: 0 ms	Range: 0 to 65535 ms in steps of 1
	⇅	FLEXCURVE A TIME AT 0.05 xPKP: 0 ms	Range: 0 to 65535 ms in steps of 1
	⇅	FLEXCURVE A TIME AT 20.00xPKP: 0 ms	Range: 0 to 65535 ms in steps of 1

FlexCurves A through D have settings for entering times to reset and operate at the following pickup levels: 0.00 to 0.98 and 1.03 to 20.00. This data is converted into two continuous curves by linear interpolation between data points. To enter a custom FlexCurve, enter the reset and operate times (using the **VALUE** keys) for each selected pickup point (using the **MESSAGE** up/down keys) for the required protection curve (A, B, C, or D).

Table 5-20: FlexCurve table

Reset	Time ms	Reset	Time ms	Operate	Time ms	Operate	Time ms	Operate	Time ms	Operate	Time ms
0.00		0.68		1.03		2.9		4.9		10.5	
0.05		0.70		1.05		3.0		5.0		11.0	
0.10		0.72		1.1		3.1		5.1		11.5	
0.15		0.74		1.2		3.2		5.2		12.0	
0.20		0.76		1.3		3.3		5.3		12.5	
0.25		0.78		1.4		3.4		5.4		13.0	
0.30		0.80		1.5		3.5		5.5		13.5	
0.35		0.82		1.6		3.6		5.6		14.0	
0.40		0.84		1.7		3.7		5.7		14.5	
0.45		0.86		1.8		3.8		5.8		15.0	
0.48		0.88		1.9		3.9		5.9		15.5	
0.50		0.90		2.0		4.0		6.0		16.0	
0.52		0.91		2.1		4.1		6.5		16.5	
0.54		0.92		2.2		4.2		7.0		17.0	
0.56		0.93		2.3		4.3		7.5		17.5	
0.58		0.94		2.4		4.4		8.0		18.0	
0.60		0.95		2.5		4.5		8.5		18.5	
0.62		0.96		2.6		4.6		9.0		19.0	
0.64		0.97		2.7		4.7		9.5		19.5	
0.66		0.98		2.8		4.8		10.0		20.0	



The relay using a given FlexCurve applies linear approximation for times between the user-entered points. Take care when setting the two points that are close to the multiple of pickup of 1; that is, 0.98 pu and 1.03 pu. It is recommended to set the two times to a similar value, otherwise the linear approximation can result in undesired behavior for the operating quantity that is close to 1.00 pu.

### 5.5.7.2 FlexCurve configuration with EnerVista software

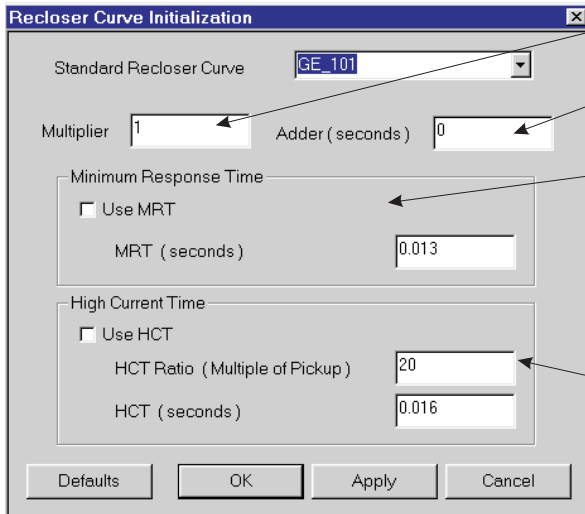
The EnerVista software allows for easy configuration and management of FlexCurves and their associated data points. Prospective FlexCurves can be configured from a selection of standard curves to provide the best approximate fit, then specific data points can be edited afterwards. Alternately, curve data can be imported from a specified file (.csv format) by selecting the EnerVista **Import Data From** setting (**Settings > System Setup > FlexCurves > FlexCurve**).

Curves and data can be exported, viewed, and cleared by clicking the appropriate buttons. FlexCurves are customized by editing the operating time (ms) values at pre-defined per-unit current multiples. Note that the pickup multiples start at zero (implying the "reset time"), operating time below pickup, and operating time above pickup.

### 5.5.7.3 Recloser curve editing

Recloser curve selection is special in that recloser curves can be shaped into a composite curve with a minimum response time and a fixed time above a specified pickup multiples. There are 41 recloser curve types supported. These definite operating times are useful to coordinate operating times, typically at higher currents and where upstream and downstream protective devices have different operating characteristics. The recloser curve configuration window shown here appears when the **Initialize From** setting in the EnerVista software is set to "Recloser Curve" and the **Initialize FlexCurve** button is clicked.

Figure 5-78: Recloser curve initialization



**Multiplier:** Scales (multiplies) the curve operating times

**Add:** Adds the time specified in this field (in ms) to each curve operating time value.

**Minimum Response Time (MRT):** If enabled, the MRT setting defines the shortest operating time even if the curve suggests a shorter time at higher current multiples. A composite operating characteristic is effectively defined. For current multiples lower than the intersection point, the curve dictates the operating time; otherwise, the MRT does. An information message appears when attempting to apply an MRT shorter than the minimum curve time.

**High Current Time:** Allows the user to set a pickup multiple from which point onwards the operating time is fixed. This is normally only required at higher current levels. The **HCT Ratio** defines the high current pickup multiple; the **HCT** defines the operating time.

842721A1.CDR



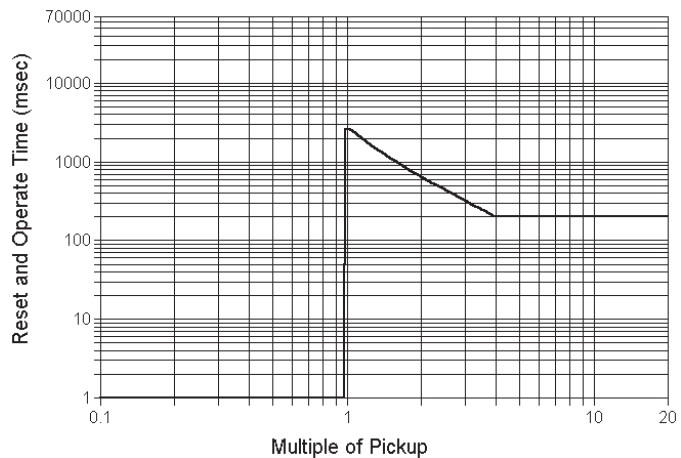
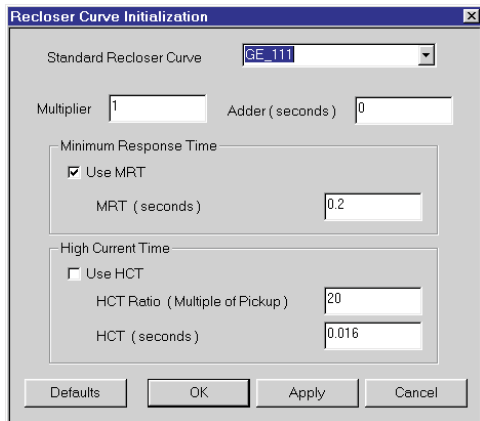
The **Multiplier** and **Adder** settings only affect the curve portion of the characteristic and not the MRT and HCT settings. The HCT settings override the MRT settings for multiples of pickup greater than the HCT ratio.

5

5.5.7.4 Example

A composite curve can be created from the GE\_111 standard with MRT = 200 ms and HCT initially disabled and then enabled at eight times pickup with an operating time of 30 ms. At approximately four times pickup, the curve operating time is equal to the MRT and from then onwards the operating time remains at 200 ms.

Figure 5-79: Composite recloser curve with HCT disabled



842719A1.CDR

With the HCT feature enabled, the operating time reduces to 30 ms for pickup multiples exceeding eight times pickup.

Figure 5-80: Composite recloser curve with HCT enabled

**Recloser Curve Initialization**

Standard Recloser Curve: GE\_111

Multiplier: 1    Adder (seconds): 0

Minimum Response Time

Use MRT

MRT (seconds): 0.2

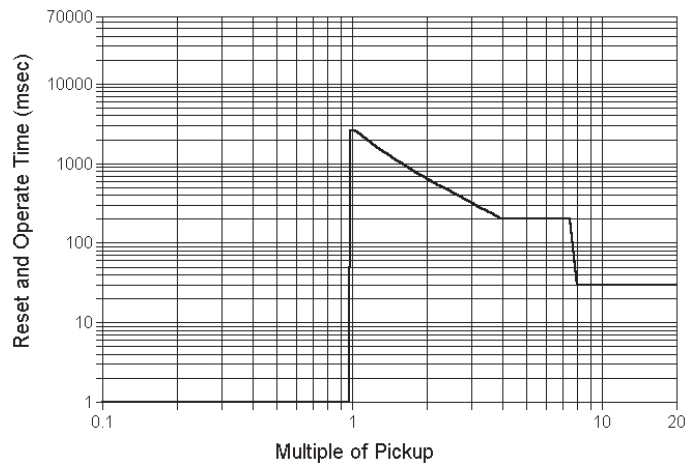
High Current Time

Use HCT

HCT Ratio (Multiple of Pickup): 8

HCT (seconds): 0.03

Buttons: Defaults, OK, Apply, Cancel



842720A1.CDR

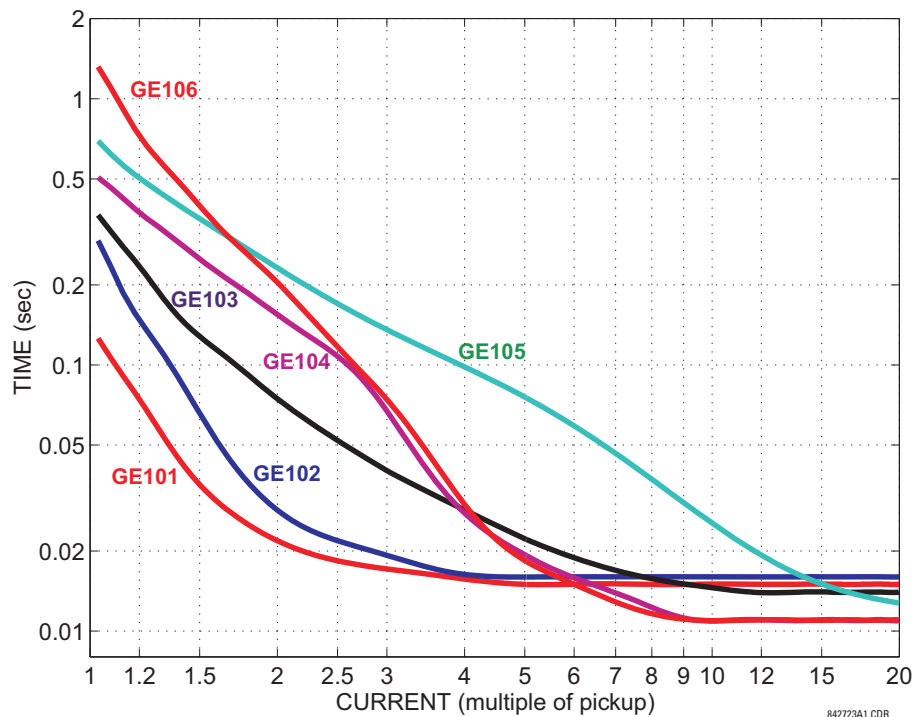


Configuring a composite curve with an increase in operating time at increased pickup multiples is not allowed. If this is attempted, the EnerVista software generates an error message and discards the proposed changes.

### 5.5.7.5 Standard recloser curves

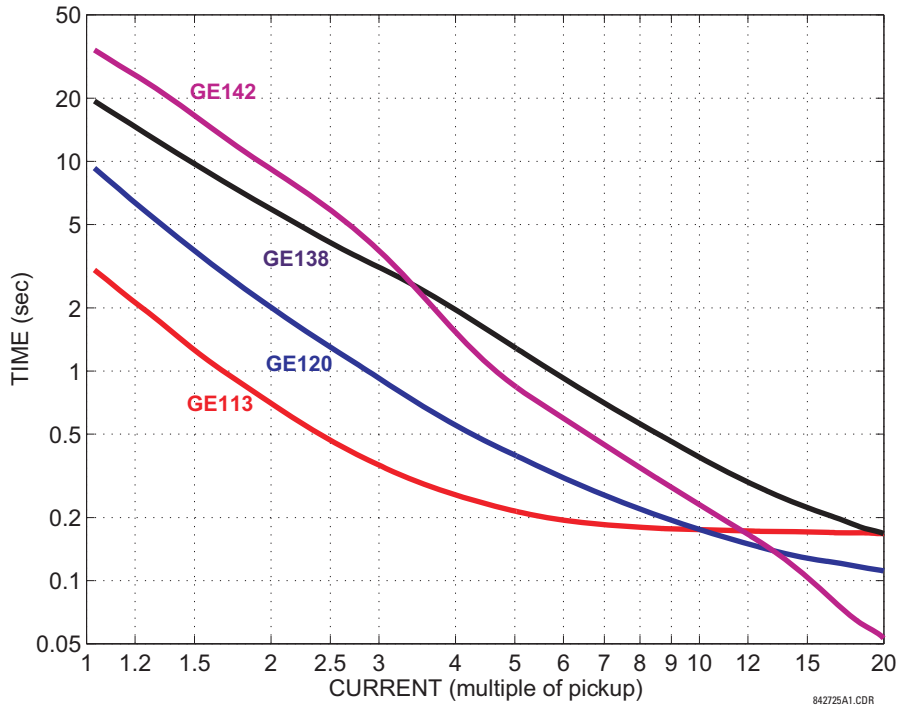
The following graphs display standard recloser curves available for the G30.

Figure 5-81: Recloser curves GE101 to GE106



842723A1.CDR

Figure 5-82: Recloser curves GE113, GE120, GE138, and GE142



5

Figure 5-83: Recloser curves GE134, GE137, GE140, GE151, and GE201

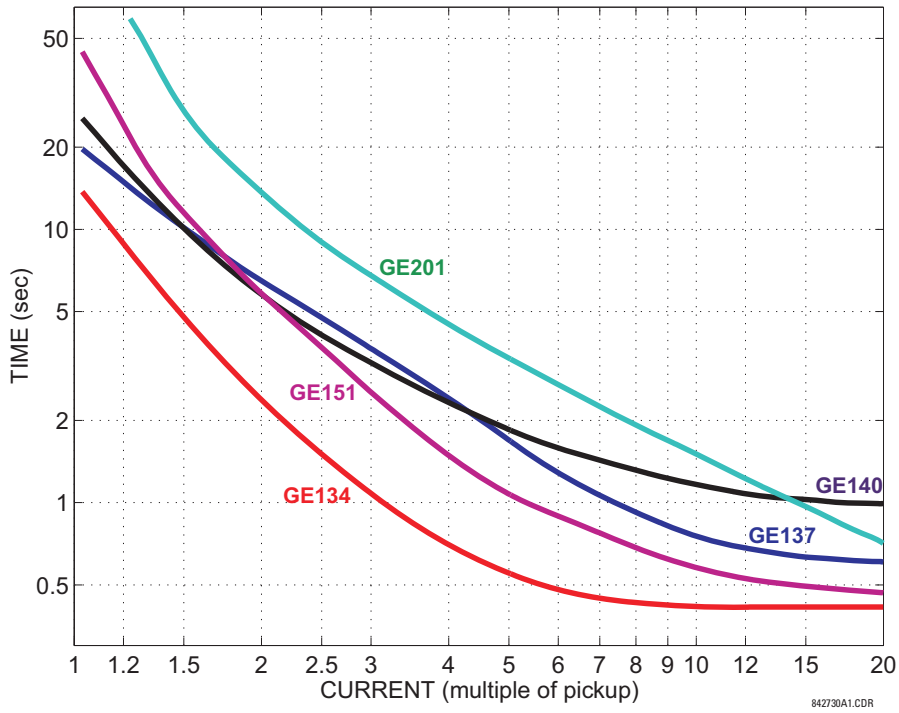




Figure 5-84: Recloser curves GE131, GE141, GE152, and GE200

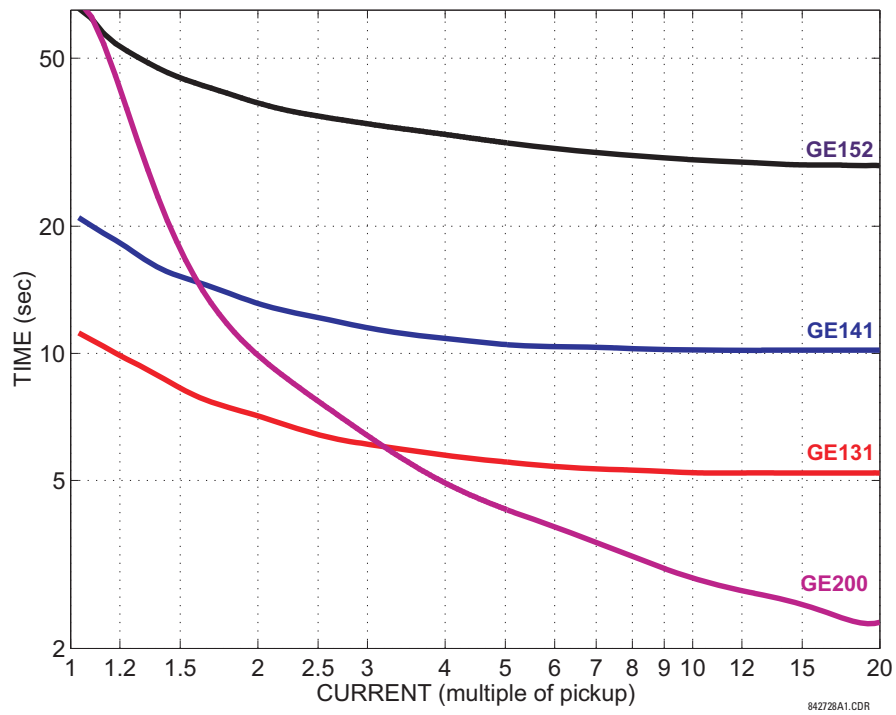


Figure 5-85: Recloser curves GE133, GE161, GE162, GE163, GE164, and GE165

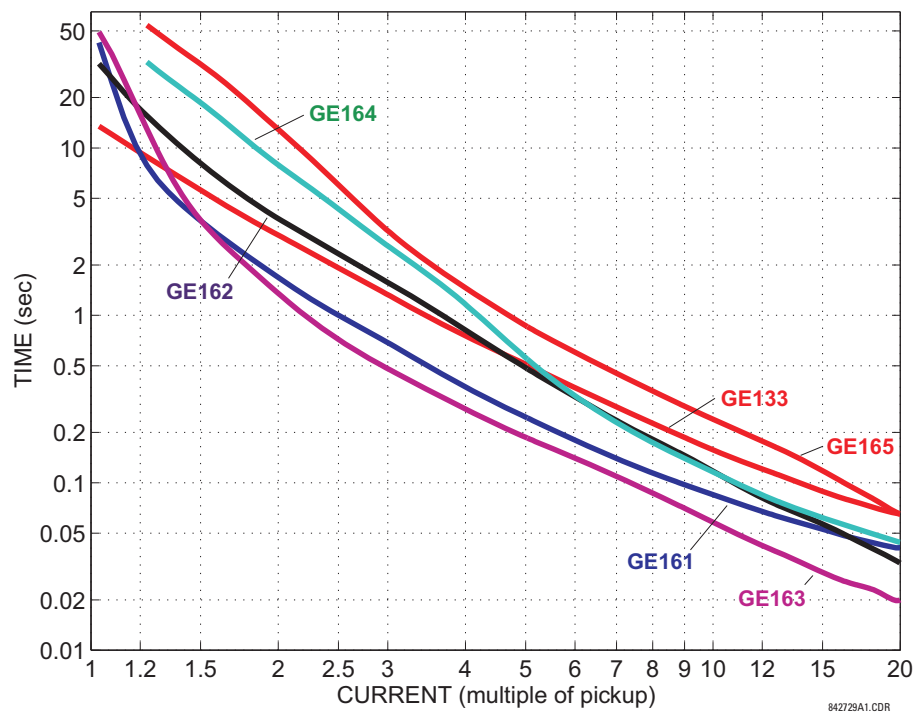


Figure 5-86: Recloser curves GE116, GE117, GE118, GE132, GE136, and GE139

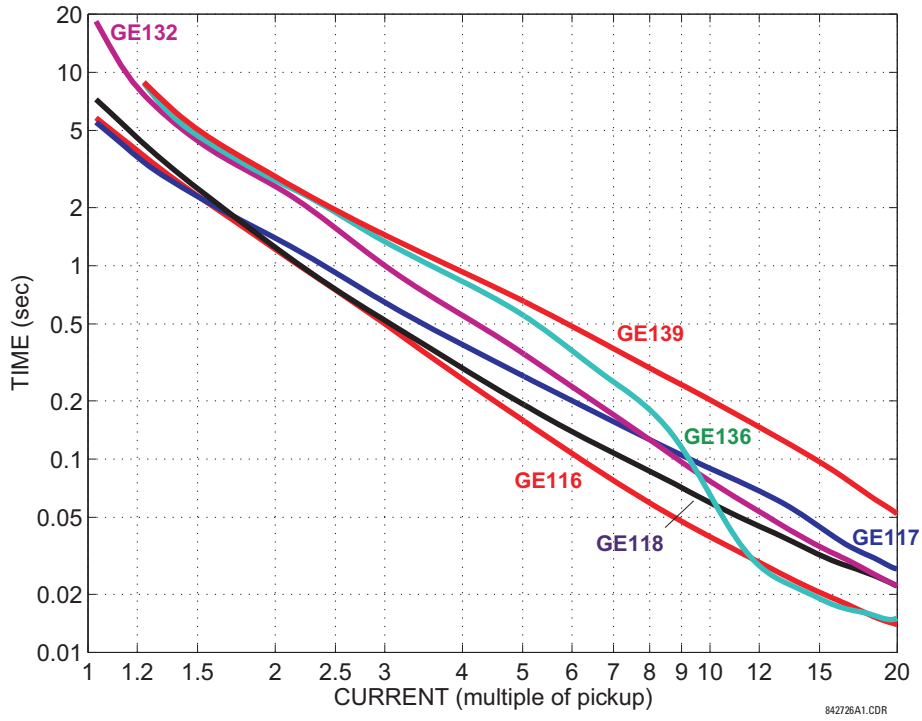


Figure 5-87: Recloser curves GE107, GE111, GE112, GE114, GE115, GE121, and GE122

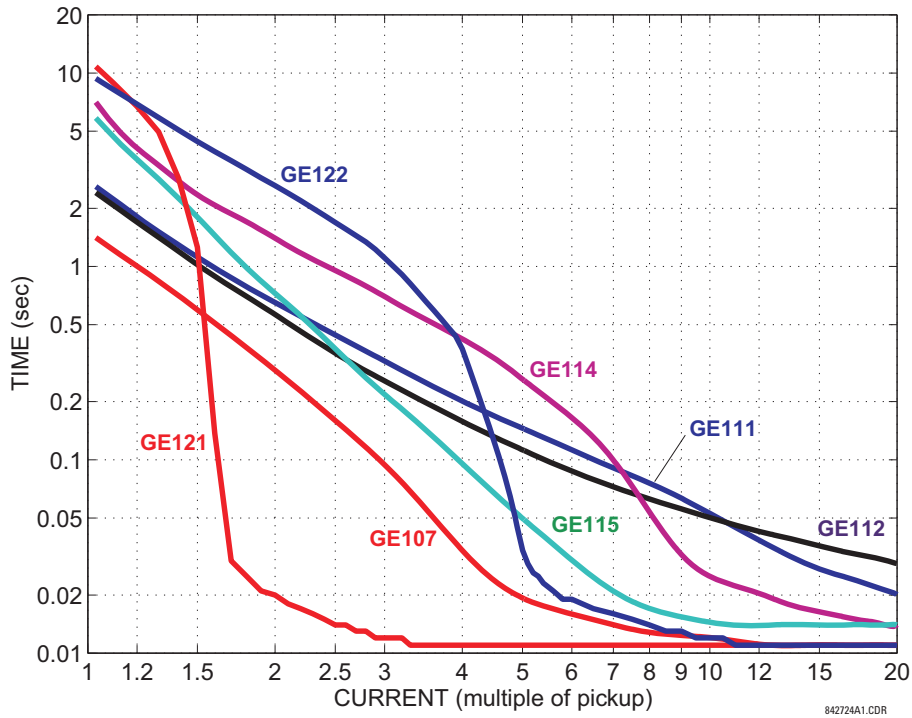
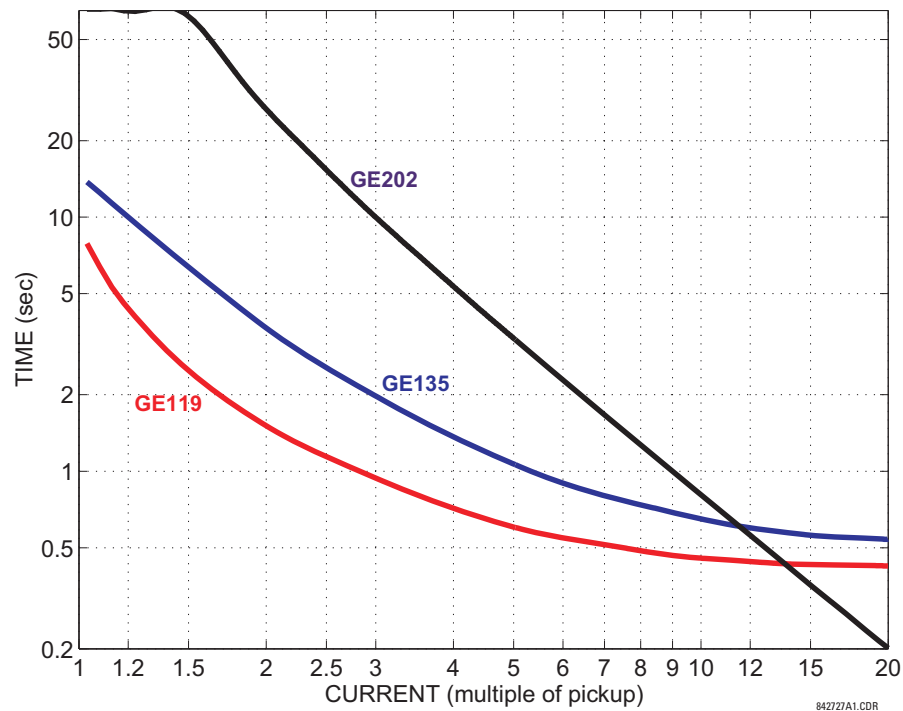


Figure 5-88: Recloser curves GE119, GE135, and GE202

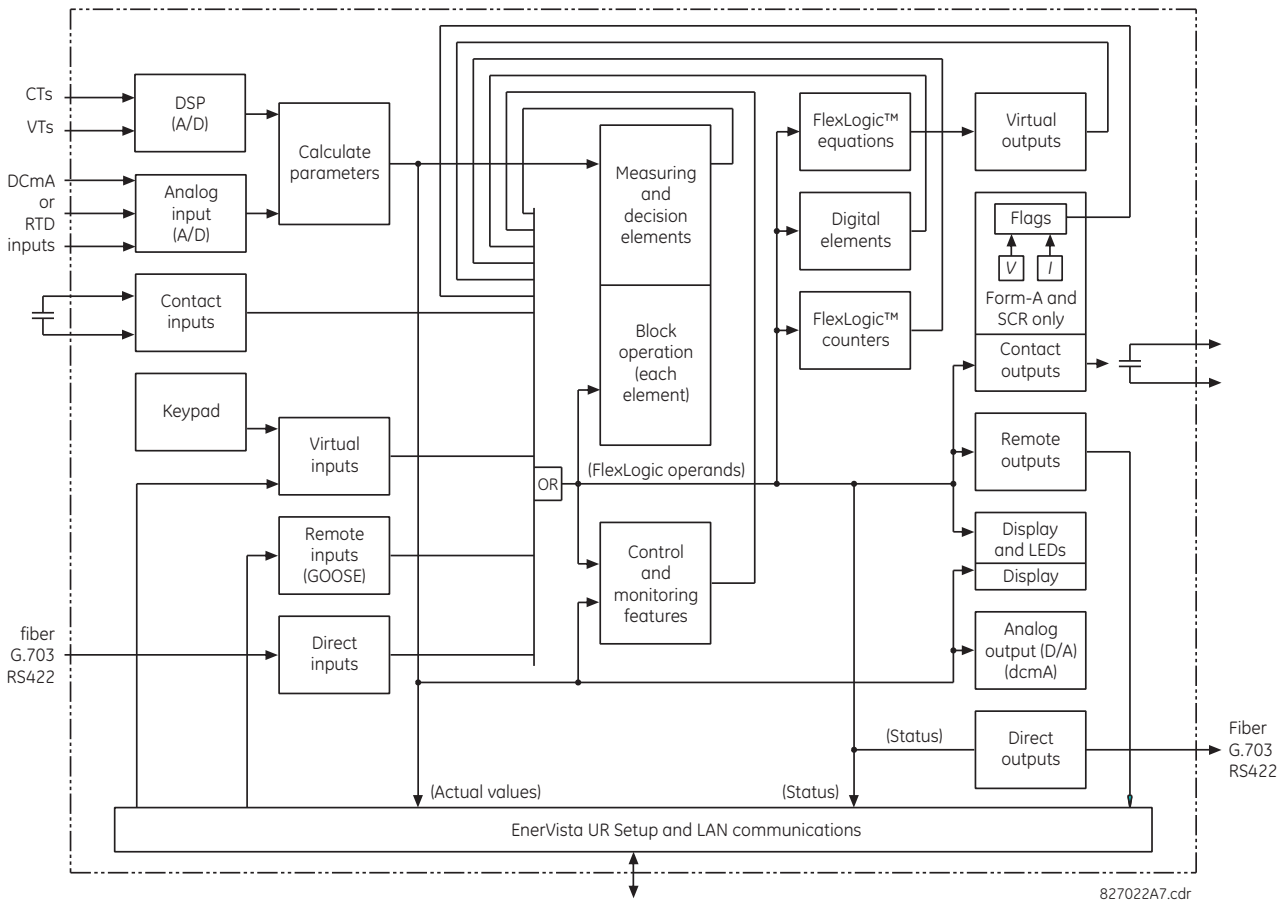


## 5.6 FlexLogic

### 5.6.1 FlexLogic operands

For flexibility, the arrangement of internal digital logic combines fixed and user-programmed parameters. Logic upon which individual features are designed is fixed, and all other logic, from contact input signals through elements or combinations of elements to contact outputs, is variable. The user has complete control of all variable logic through FlexLogic. In general, the system receives analog and digital inputs that it uses to produce analog and digital outputs. The figure shows major subsystems of a generic UR-series relay involved in this process.

Figure 5-89: UR architecture overview



The states of all digital signals used in the G30 are represented by flags (or FlexLogic operands, which are described later in this section). A digital “1” is represented by a set flag. Any external contact change-of-state can be used to block an element from operating, as an input to a control feature in a FlexLogic equation, or to operate a contact output. The state of the contact input can be displayed locally or viewed remotely via the communications facilities provided. If a simple scheme where a contact input is used to block an element is wanted, this selection is made when programming the element. This capability also applies to the other features that set flags: elements, virtual inputs, remote inputs, schemes, and human operators.

If more complex logic than shown in the figure is required, it is implemented via FlexLogic. For example, to have the closed state of contact input H7a and the operated state of the phase undervoltage element block the operation of the phase time overcurrent element, the two control input states are programmed in a FlexLogic equation. This equation ANDs the two control inputs to produce a virtual output that is then selected when programming the phase time overcurrent to be used as a blocking input. Virtual outputs can only be created by FlexLogic equations.

Traditionally, protective relay logic has been relatively limited. Any unusual applications involving interlocks, blocking, or supervisory functions had to be hard-wired using contact inputs and outputs. FlexLogic minimizes the requirement for auxiliary components and wiring while making more complex schemes possible.

The logic that determines the interaction of inputs, elements, schemes, and outputs is field-programmable through the use of logic equations that are sequentially processed. The use of virtual inputs and outputs in addition to hardware is available internally and on the communication ports for other relays to use (distributed FlexLogic).

FlexLogic allows users to customize the relay through a series of equations that consist of operators and operands. The operands are the states of inputs, elements, schemes, and outputs. The operators are logic gates, timers, and latches (with set and reset inputs). A system of sequential operations allows any combination of operands to be assigned as inputs to

specified operators to create an output. The final output of an equation is a numbered register called a virtual output. Virtual outputs can be used as an input operand in any equation, including the equation that generates the output, as a seal-in or other type of feedback.

A FlexLogic equation consists of parameters that are either operands or operators. Operands have a logic state of 1 or 0. Operators provide a defined function, such as an AND gate or a Timer. Each equation defines the combinations of parameters to be used to set a Virtual Output flag. Evaluation of an equation results in either a 1 (=ON, or flag set) or 0 (=OFF, or flag not set). Each equation is evaluated at least four times every power system cycle.

Some types of operands are present in the relay in multiple instances, for example contact and remote inputs. These types of operands are grouped together (for presentation purposes only) on the front panel display. The table lists characteristics of the different types of operands.

**Table 5-21: G30 FlexLogic operand types**

Operand type	State	Example of format	Characteristics [Input is '1' (= ON) if...]
Contact Input	On	Cont Ip On	Voltage is applied presently to the input (external contact closed)
	Off	Cont Ip Off	Voltage is not applied presently to the input (external contact open)
Contact Output (type Form-A contact only)	Contact Closed	Cont Op 1 Closed	Contact output is closed
	Current On	Cont Op 1 Ion	Current is flowing through the contact
	Voltage On	Cont Op 1 VOn	Voltage exists across the contact
	Voltage Off	Cont Op 1 VOff	Voltage does not exist across the contact
Direct Input	On	DIRECT INPUT 1 On	The direct input is presently in the ON state
Element (Analog)	Pickup	PHASE TOC1 PKP	The tested parameter is presently above the pickup setting of an element that responds to rising values or below the pickup setting of an element that responds to falling values
	Dropout	PHASE TOC1 DPO	This operand is the logical inverse of the above PKP operand
	Operate	PHASE TOC1 OP	The tested parameter has been above/below the pickup setting of the element for the programmed delay time, or has been at logic 1 and is now at logic 0 but the reset timer has not finished timing
	Block	PHASE TOC1 BLK	The output of the comparator is set to the block function
Element (Digital)	Pickup	Dig Element 1 PKP	The input operand is at logic 1
	Dropout	Dig Element 1 DPO	This operand is the logical inverse of the above PKP operand
	Operate	Dig Element 1 OP	The input operand has been at logic 1 for the programmed pickup delay time, or has been at logic 1 for this period and is now at logic 0 but the reset timer has not finished timing
Element (Digital Counter)	Higher than	Counter 1 HI	The number of pulses counted is above the set number
	Equal to	Counter 1 EQL	The number of pulses counted is equal to the set number
	Lower than	Counter 1 LO	The number of pulses counted is below the set number
Fixed	On	On	Logic 1
	Off	Off	Logic 0
RxGOOSE Boolean	On	RxGOOSE Boolean 1 On	The RxGOOSE Boolean is presently in the ON state
Virtual Input	On	Virt Ip 1 On	The virtual input is presently in the ON state
Virtual Output	On	Virt Op 1 On	The virtual output is presently in the set state (that is, evaluation of the equation that produces this virtual output results in a "1")

The following table lists the operands available for the relay. The operands can be viewed online by entering the IP address of the relay in a web browser and accessing the Device Information Menu.

Table 5-22: G30 FlexLogic operands

Operand type	Operand syntax	Operand description
ANNUNCIATOR Graphical front panel	ANY ANCTR ABNORMAL  ANY ANCTR ALARMED	On for one second when any annunciator window state changes from normal to abnormal On while any annunciator window state is abnormal
CONTROL PUSHBUTTONS Enhanced and basic front panels	CONTROL PUSHBTN 1 ON CONTROL PUSHBTN 2 ON CONTROL PUSHBTN 3 ON CONTROL PUSHBTN 4 ON CONTROL PUSHBTN 5 ON CONTROL PUSHBTN 6 ON CONTROL PUSHBTN 7 ON	Control pushbutton 1 is being pressed Control pushbutton 2 is being pressed Control pushbutton 3 is being pressed Control pushbutton 4 is being pressed Control pushbutton 5 is being pressed Control pushbutton 6 is being pressed Control pushbutton 7 is being pressed
CYBERSENTRY	ROLE ADMIN ACT ROLE SUPERVISOR ACT ROLE ENGINEER ACT ROLE OPERATOR ACT ROLE OBSERVER ACT AUTHENTICATION FAIL UNAUTH FW ATTEMPT UNAUTH SETTING WRITE	Administrator role is active and is set to true when that is the case Supervisor role is active and is set to true when that is the case Engineer role is active and is set to true when that is the case Operator role is active and is set to true when that is the case Observer role is active and is set to true when that is the case Operand set for Failed Authentication self-test and alarm Operand set for firmware lock self-test and alarm Operand set for settings lock self-test and alarm
DIRECT DEVICES	DIRECT DEVICE 1On ↓ DIRECT DEVICE 16On DIRECT DEVICE 1Off ↓ DIRECT DEVICE 16Off	Flag is set, logic=1 ↓ Flag is set, logic=1 Flag is set, logic=1 ↓ Flag is set, logic=1
DIRECT INPUT/ OUTPUT CHANNEL MONITORING	DIR IO CH1 CRC ALARM  DIR IO CH2 CRC ALARM  DIR IO CH1 UNRET ALM  DIR IO CH2 UNRET ALM	The rate of direct input messages received on channel 1 and failing the CRC exceeded the user-specified level The rate of direct input messages received on channel 2 and failing the CRC exceeded the user-specified level The rate of returned direct input/output messages on channel 1 exceeded the user-specified level (ring configurations only) The rate of returned direct input/output messages on channel 2 exceeded the user-specified level (ring configurations only)
ELEMENT: Third harmonic neutral undervoltage	3RD HARM NTRL UV PKP 3RD HARM NTRL UV OP 3RD HARM NTRL UV DPO	Third harmonic neutral undervoltage element has picked up Third harmonic neutral undervoltage element has operated Third harmonic neutral undervoltage element has dropped out
ELEMENT: Accidental energization	ACCDNT ENRG ARMED ACCDNT ENRG DPO ACCDNT ENRG OP	The accidental energization element is armed The accidental energization element has dropped out The accidental energization element has operated
ELEMENT: Auxiliary overvoltage	AUX OV1 PKP AUX OV1 DPO AUX OV1 OP	Auxiliary overvoltage element has picked up Auxiliary overvoltage element has dropped out Auxiliary overvoltage element has operated
	AUX OV2	Same set of operands as shown for AUX OV1
ELEMENT: Auxiliary undervoltage	AUX UV1 PKP AUX UV1 DPO AUX UV1 OP	Auxiliary undervoltage element has picked up Auxiliary undervoltage element has dropped out Auxiliary undervoltage element has operated
	AUX UV2 to 3	Same set of operands as shown for AUX UV1
ELEMENT: Breaker arcing	BKR ARC 1 OP BKR ARC 1 DPO BKR ARC 1 MAX OP BKR ARC 1 MAX DPO BKR ARC 2 OP BKR ARC 2 DPO BKR ARC 2 MAX OP BKR ARC 2 MAX DPO	Breaker arcing current 1 has operated Breaker arcing current 1 has dropped out Breaker arcing current 1 max interrupting current has operated Breaker arcing current 1 max interrupting current has dropped out Breaker arcing current 2 has operated Breaker arcing current 2 has dropped out Breaker arcing current 2 max interrupting current has operated Breaker arcing current 2 max interrupting current has dropped out

Operand type	Operand syntax	Operand description
ELEMENT: Breaker control	BREAKER 1 OFF CMD BREAKER 1 ON CMD BREAKER 1 $\Phi$ A BAD ST  BREAKER 1 $\Phi$ A INTERM  BREAKER 1 $\Phi$ A CLSD BREAKER 1 $\Phi$ A OPEN BREAKER 1 $\Phi$ B BAD ST  BREAKER 1 $\Phi$ B INTERM  BREAKER 1 $\Phi$ B CLSD BREAKER 1 $\Phi$ B OPEN BREAKER 1 $\Phi$ C BAD ST  BREAKER 1 $\Phi$ C INTERM  BREAKER 1 $\Phi$ C CLSD BREAKER 1 $\Phi$ C OPEN BREAKER 1 BAD STATUS BREAKER 1 CLOSED BREAKER 1 OPEN BREAKER 1 DISCREP BREAKER 1 TROUBLE BREAKER 1 MNL OPEN BREAKER 1 MNL CLS BREAKER 1 TRIP A BREAKER 1 TRIP B BREAKER 1 TRIP C BREAKER 1 ANY P OPEN BREAKER 1 ONE P OPEN BREAKER 1 OOS BREAKER 1 TAG ON BREAKER 1 TAG OFF BREAKER 1 SUBD CLSD BREAKER 1 SUBD OPEN BREAKER 1 BYPASS ON BREAKER 1 BYPASS OFF BREAKER 1 BLK RCLS BREAKER 1 ENA RCLS	Breaker 1 3-pole open command/trip initiated Breaker 1 close command initiated Breaker 1 phase A bad status is detected (discrepancy between the 52/a and 52/b contacts) Breaker 1 phase A intermediate status is detected (transition from one position to another) Breaker 1 phase A is closed Breaker 1 phase A is open Breaker 1 phase B bad status is detected (discrepancy between the 52/a and 52/b contacts) Breaker 1 phase B intermediate status is detected (transition from one position to another) Breaker 1 phase B is closed Breaker 1 phase B is open Breaker 1 phase C bad status is detected (discrepancy between the 52/a and 52/b contacts) Breaker 1 phase C intermediate status is detected (transition from one position to another) Breaker 1 phase C is closed Breaker 1 phase C is open Breaker 1 bad status is detected on any pole Breaker 1 is closed Breaker 1 is open Breaker 1 has discrepancy Breaker 1 trouble alarm Breaker 1 manual open Breaker 1 manual close Breaker 1 trip phase A command Breaker 1 trip phase B command Breaker 1 trip phase C command At least one pole of breaker 1 is open Only one pole of breaker 1 is open Breaker 1 is out of service Breaker 1 tagged so manual trip and close and autoreclose are blocked Breaker 1 not tagged Breaker 1 status manually substituted to closed Breaker 1 status manually substituted to open Breaker 1 control interlocking is manually bypassed Breaker 1 control interlocking is not manually bypassed Breaker 1 command to manually block autoreclose Breaker 1 command to manually enable autoreclose
	BREAKER 2	Same set of operands as shown for BREAKER 1
ELEMENT: CT fail	CT FAIL 1 PKP CT FAIL 1 OP	CT fail has picked up CT fail has dropped out
	CT FAIL 2 to 4	Same set of operands as per CT FAIL 1
ELEMENT: Digital counters	Counter 1 HI Counter 1 EQL Counter 1 LO	Digital counter 1 output is 'more than' comparison value Digital counter 1 output is 'equal to' comparison value Digital counter 1 output is 'less than' comparison value
	Counter 2 to 8	Same set of operands as shown for Counter 1
ELEMENT: Digital elements	Dig Element 1 PKP Dig Element 1 OP Dig Element 1 DPO	Digital Element 1 is picked up Digital Element 1 is operated Digital Element 1 is dropped out
	Dig Element 2 to 48	Same set of operands as shown for Dig Element 1
ELEMENT: Sensitive directional power	DIR POWER 1 STG1 PKP DIR POWER 1 STG2 PKP DIR POWER 1 STG1 DPO DIR POWER 1 STG2 DPO DIR POWER 1 STG1 OP DIR POWER 1 STG2 OP DIR POWER 1 PKP DIR POWER 1 DPO DIR POWER 1 OP	Stage 1 of the directional power element 1 has picked up Stage 2 of the directional power element 1 has picked up Stage 1 of the directional power element 1 has dropped out Stage 2 of the directional power element 1 has dropped out Stage 1 of the directional power element 1 has operated Stage 2 of the directional power element 1 has operated The directional power element has picked up The directional power element has dropped out The directional power element has operated
	DIR POWER 2	Same set of operands as DIR POWER 1

Operand type	Operand syntax	Operand description
ELEMENT: Frequency out-of-band accumulation	FREQ OOB BAND 1 PKP FREQ OOB BAND 1 DPO FREQ OOB BAND 1 OP FREQ OOB ACCUM PKP FREQ OOB ACCUM OP	Asserted when the frequency accumulation in band 1 is active Asserted when the frequency accumulation in band 1 is inactive Asserted when the frequency accumulator in band 1 operates Asserted when the frequency accumulator in any band is active Asserted when the frequency accumulator in any band operates
	FREQ OOB BAND 2 to 7	Same set of operands as shown for band 1
ELEMENT: Frequency rate of change	FREQ RATE 1 PKP FREQ RATE 1 DPO FREQ RATE 1 OP	The frequency rate of change 1 element has picked up The frequency rate of change 1 element has dropped out The frequency rate of change 1 element has operated
	FREQ RATE 2 to 4	Same set of operands as shown for FREQ RATE 1
ELEMENT: FlexElements	FxE 1 PKP FxE 1 OP FxE 1 DPO	FlexElement 1 has picked up FlexElement 1 has operated FlexElement 1 has dropped out
	FxE 2 to 16	Same set of operands as shown for FxE 1
ELEMENT: Generator unbalance	GEN UNBAL STG1 PKP GEN UNBAL STG1 DPO GEN UNBAL STG1 OP GEN UNBAL STG2 PKP GEN UNBAL STG2 DPO GEN UNBAL STG2 OP GEN UNBAL PKP GEN UNBAL DPO GEN UNBAL OP	The Generator Unbalance Stage 1 element has picked up The Generator Unbalance Stage 1 element has dropped out The Generator Unbalance Stage 1 element has operated The Generator Unbalance Stage 2 element has picked up The Generator Unbalance Stage 2 element has dropped out The Generator Unbalance Stage 2 element has operated The Generator Unbalance element has picked up The Generator Unbalance element has dropped out The Generator Unbalance element has operated
ELEMENT: Ground instantaneous overcurrent	GROUND IOC1 PKP GROUND IOC1 OP GROUND IOC1 DPO	Ground instantaneous overcurrent 1 has picked up Ground instantaneous overcurrent 1 has operated Ground instantaneous overcurrent 1 has dropped out
	GROUND TOC1 PKP GROUND TOC1 OP GROUND TOC1 DPO	Ground time overcurrent 1 has picked up Ground time overcurrent 1 has operated Ground time overcurrent 1 has dropped out
ELEMENT: Non-volatile latches	LATCH 1 ON LATCH 1 OFF	Non-volatile latch 1 is ON (Logic = 1) Non-volatile latch 1 is OFF (Logic = 0)
	LATCH 2 to 16	Same set of operands as shown for LATCH 1
ELEMENT: Loss of excitation	LOSS EXCIT STG1 PKP LOSS EXCIT STG2 PKP LOSS EXCIT STG1 DPO LOSS EXCIT STG2 DPO LOSS EXCIT STG1 OP LOSS EXCIT STG2 OP LOSS EXCIT PKP LOSS EXCIT DPO LOSS EXCIT OP	Stage 1 of the loss of excitation element has picked up Stage 2 of the loss of excitation element has picked up Stage 1 of the loss of excitation element has dropped out Stage 2 of the loss of excitation element has dropped out Stage 1 of the loss of excitation element has operated Stage 2 of the loss of excitation element has operated The loss of excitation element has picked up The loss of excitation element has dropped out The loss of excitation element has operated
ELEMENT: Negative-sequence directional overcurrent	NEG SEQ DIR OC1 FWD NEG SEQ DIR OC1 REV NEG SEQ DIR OC2 FWD NEG SEQ DIR OC2 REV	Negative-sequence directional overcurrent 1 forward has operated Negative-sequence directional overcurrent 1 reverse has operated Negative-sequence directional overcurrent 2 forward has operated Negative-sequence directional overcurrent 2 reverse has operated
	NEG SEQ OV1 PKP NEG SEQ OV1 DPO NEG SEQ OV1 OP	Negative-sequence overvoltage element has picked up Negative-sequence overvoltage element has dropped out Negative-sequence overvoltage element has operated
ELEMENT: Negative-sequence overvoltage	NEG SEQ OV2 to 3	Same set of operands as shown for NEG SEQ OV1
ELEMENT: Neutral instantaneous overcurrent	NEUTRAL IOC1 PKP NEUTRAL IOC1 OP NEUTRAL IOC1 DPO	Neutral instantaneous overcurrent 1 has picked up Neutral instantaneous overcurrent 1 has operated Neutral instantaneous overcurrent 1 has dropped out
	NEUTRAL OV1 PKP NEUTRAL OV1 DPO NEUTRAL OV1 OP	Neutral overvoltage element 1 has picked up Neutral overvoltage element 1 has dropped out Neutral overvoltage element 1 has operated
ELEMENT: Neutral overvoltage	NEUTRAL OV2 to 3	Same set of operands as shown for NEUTRAL OV1
ELEMENT: Neutral time overcurrent	NEUTRAL TOC1 PKP NEUTRAL TOC1 OP NEUTRAL TOC1 DPO	Neutral time overcurrent 1 has picked up Neutral time overcurrent 1 has operated Neutral time overcurrent 1 has dropped out



Operand type	Operand syntax	Operand description
	NEUTRAL TOC2	Same set of operands as shown for NEUTRAL TOC1
ELEMENT: Neutral directional overcurrent	NTRL DIR OC1 FWD NTRL DIR OC1 REV	Neutral directional overcurrent 1 forward has operated Neutral directional overcurrent 1 reverse has operated
	NTRL DIR OC2	Same set of operands as shown for NTRL DIR OC1
ELEMENT: Overfrequency	OVERFREQ 1 PKP OVERFREQ 1 OP OVERFREQ 1 DPO	Overfrequency 1 has picked up Overfrequency 1 has operated Overfrequency 1 has dropped out
	OVERFREQ 2 to 4	Same set of operands as shown for OVERFREQ 1
ELEMENT: Phase directional overcurrent	PH DIR1 BLK A PH DIR1 BLK B PH DIR1 BLK C PH DIR1 BLK	Phase A directional 1 block Phase B directional 1 block Phase C directional 1 block Phase directional 1 block
ELEMENT: Phase instantaneous overcurrent	PHASE IOC1 PKP PHASE IOC1 OP PHASE IOC1 DPO PHASE IOC1 PKP A PHASE IOC1 PKP B PHASE IOC1 PKP C PHASE IOC1 OP A PHASE IOC1 OP B PHASE IOC1 OP C PHASE IOC1 DPO A PHASE IOC1 DPO B PHASE IOC1 DPO C	At least one phase of phase instantaneous overcurrent 1 has picked up At least one phase of phase instantaneous overcurrent 1 has operated All phases of phase instantaneous overcurrent 1 have dropped out Phase A of phase instantaneous overcurrent 1 has picked up Phase B of phase instantaneous overcurrent 1 has picked up Phase C of phase instantaneous overcurrent 1 has picked up Phase A of phase instantaneous overcurrent 1 has operated Phase B of phase instantaneous overcurrent 1 has operated Phase C of phase instantaneous overcurrent 1 has operated Phase A of phase instantaneous overcurrent 1 has dropped out Phase B of phase instantaneous overcurrent 1 has dropped out Phase C of phase instantaneous overcurrent 1 has dropped out
	PHASE IOC2 to 4	Same set of operands as shown for PHASE IOC1
ELEMENT: Phase overvoltage	PHASE OV1 PKP PHASE OV1 OP PHASE OV1 DPO PHASE OV1 PKP A PHASE OV1 PKP B PHASE OV1 PKP C PHASE OV1 OP A PHASE OV1 OP B PHASE OV1 OP C PHASE OV1 DPO A PHASE OV1 DPO B PHASE OV1 DPO C	At least one phase of overvoltage 1 has picked up At least one phase of overvoltage 1 has operated All phases of overvoltage 1 have dropped out Phase A of overvoltage 1 has picked up Phase B of overvoltage 1 has picked up Phase C of overvoltage 1 has picked up Phase A of overvoltage 1 has operated Phase B of overvoltage 1 has operated Phase C of overvoltage 1 has operated Phase A of overvoltage 1 has dropped out Phase B of overvoltage 1 has dropped out Phase C of overvoltage 1 has dropped out
	PHASE OV2 to 3	Same set of operands as shown for PHASE OV1
ELEMENT: Phase time overcurrent	PHASE TOC1 PKP PHASE TOC1 OP PHASE TOC1 DPO PHASE TOC1 PKP A PHASE TOC1 PKP B PHASE TOC1 PKP C PHASE TOC1 OP A PHASE TOC1 OP B PHASE TOC1 OP C PHASE TOC1 DPO A PHASE TOC1 DPO B PHASE TOC1 DPO C	At least one phase of phase time overcurrent 1 has picked up At least one phase of phase time overcurrent 1 has operated All phases of phase time overcurrent 1 have dropped out Phase A of phase time overcurrent 1 has picked up Phase B of phase time overcurrent 1 has picked up Phase C of phase time overcurrent 1 has picked up Phase A of phase time overcurrent 1 has operated Phase B of phase time overcurrent 1 has operated Phase C of phase time overcurrent 1 has operated Phase A of phase time overcurrent 1 has dropped out Phase B of phase time overcurrent 1 has dropped out Phase C of phase time overcurrent 1 has dropped out
	PHASE TOC2	Same set of operands as shown for PHASE TOC1
ELEMENT: Phase undervoltage	PHASE UV1 PKP PHASE UV1 OP PHASE UV1 DPO PHASE UV1 PKP A PHASE UV1 PKP B PHASE UV1 PKP C PHASE UV1 OP A PHASE UV1 OP B PHASE UV1 OP C PHASE UV1 DPO A PHASE UV1 DPO B PHASE UV1 DPO C	At least one phase of phase undervoltage 1 has picked up At least one phase of phase undervoltage 1 has operated All phases of phase undervoltage 1 have dropped out Phase A of phase undervoltage 1 has picked up Phase B of phase undervoltage 1 has picked up Phase C of phase undervoltage 1 has picked up Phase A of phase undervoltage 1 has operated Phase B of phase undervoltage 1 has operated Phase C of phase undervoltage 1 has operated Phase A of phase undervoltage 1 has dropped out Phase B of phase undervoltage 1 has dropped out Phase C of phase undervoltage 1 has dropped out

Operand type	Operand syntax	Operand description
	PHASE UV2 to 3	Same set of operands as shown for PHASE UV1
ELEMENT: Restricted ground fault	RESTD GND FT1 PKP RESTD GND FT1 OP RESTD GND FT1 DPO	Restricted ground fault 1 has picked up Restricted ground fault 1 has operated Restricted ground fault 1 has dropped out
	RESTD GND FT2 to 4	Same set of operands as shown for RESTD GND FT1
ELEMENT: Selector switch	SELECTOR 1 POS Y SELECTOR 1 BIT 0 SELECTOR 1 BIT 1 SELECTOR 1 BIT 2 SELECTOR 1 STP ALARM  SELECTOR 1 BIT ALARM  SELECTOR 1 ALARM SELECTOR 1 PWR ALARM	Selector switch 1 is in Position Y (mutually exclusive operands) First bit of the 3-bit word encoding position of selector 1 Second bit of the 3-bit word encoding position of selector 1 Third bit of the 3-bit word encoding position of selector 1 Position of selector 1 has been pre-selected with the stepping up control input but not acknowledged Position of selector 1 has been pre-selected with the 3-bit control input but not acknowledged Position of selector 1 has been pre-selected but not acknowledged Position of selector switch 1 is undetermined or restored from memory when the relay powers up and synchronizes to the three-bit input
	SELECTOR 2	Same set of operands as shown for SELECTOR 1
ELEMENT: Setting group	SETTING GROUP ACT 1 SETTING GROUP ACT 2 SETTING GROUP ACT 3 SETTING GROUP ACT 4 SETTING GROUP ACT 5 SETTING GROUP ACT 6	Setting group 1 is active Setting group 2 is active Setting group 3 is active Setting group 4 is active Setting group 5 is active Setting group 6 is active
ELEMENT: Split phase protection	SPLIT PHASE A PKP SPLIT PHASE A DPO SPLIT PHASE A OP SPLIT PHASE B PKP SPLIT PHASE B DPO SPLIT PHASE B OP SPLIT PHASE C PKP SPLIT PHASE C DPO SPLIT PHASE C OP SPLIT PHASE OP SPLIT PHASE PKP SPLIT PHASE DPO	Phase A of the split phase protection has picked up Phase A of the split phase protection has dropped out Phase A of the split phase protection has operated Phase B of the split phase protection has picked up Phase B of the split phase protection has dropped out Phase B of the split phase protection has operated Phase C of the split phase protection has picked up Phase C of the split phase protection has dropped out Phase C of the split phase protection has operated The split phase protection has operated The split phase protection has operated The split phase protection has picked up The split phase protection has dropped out
ELEMENT: Disturbance detector	SRC1 50DD OP SRC2 50DD OP SRC3 50DD OP SRC4 50DD OP	Source 1 disturbance detector has operated Source 2 disturbance detector has operated Source 3 disturbance detector has operated Source 4 disturbance detector has operated
ELEMENT: VTFF (Voltage transformer fuse failure)	SRC1 VT FF OP SRC1 VT FF DPO SRC1 VT FF VOL LOSS SRC1 VT FF ALARM	Source 1 VT fuse failure detector has operated Source 1 VT fuse failure detector has dropped out Source 1 has lost voltage signals (V2 below 10% and V1 below 5% of nominal) Source 1 has triggered a VT fuse failure alarm
	SRC1 VT NEU WIRE OPEN	Source 1 VT neutral wire open detected. When the VT is connected in Delta, do not enable this function because there is no neutral wire for Delta connected VT.
	SRC2 VT FUSE FAIL to SRC4	Same set of operands as shown for SRC1 VT FF

Operand type	Operand syntax	Operand description
ELEMENT: Disconnect switch	SWITCH 1 OFF CMD SWITCH 1 ON CMD SWITCH 1 CLOSED SWITCH 1 OPEN SWITCH 1 DISCREP SWITCH 1 TROUBLE SWITCH 1 ΦA CLSD SWITCH 1 ΦA OPEN SWITCH 1 ΦA BAD ST  SWITCH 1 ΦA INTERM  SWITCH 1 ΦB CLSD SWITCH 1 ΦB OPEN SWITCH 1 ΦB BAD ST  SWITCH 1 ΦB INTERM  SWITCH 1 ΦC CLSD SWITCH 1 ΦC OPEN SWITCH 1 ΦC BAD ST  SWITCH 1 ΦC INTERM  SWITCH 1 BAD STATUS SWITCH 1 TAG ON SWITCH 1 TAG OFF SWITCH 1 SUBD CLSD SWITCH 1 SUBD OPEN SWITCH 1 BYPASS ON SWITCH 1 BYPASS OFF	Disconnect switch 1 open command initiated Disconnect switch 1 close command initiated Disconnect switch 1 is closed Disconnect switch 1 is open Disconnect switch 1 has discrepancy Disconnect switch 1 trouble alarm Disconnect switch 1 phase A is closed Disconnect switch 1 phase A is open Disconnect switch 1 phase A bad status is detected (discrepancy between the 89/a and 89/b contacts) Disconnect switch 1 phase A intermediate status is detected (transition from one position to another) Disconnect switch 1 phase B is closed Disconnect switch 1 phase B is open Disconnect switch 1 phase B bad status is detected (discrepancy between the 89/a and 89/b contacts) Disconnect switch 1 phase B intermediate status is detected (transition from one position to another) Disconnect switch 1 phase C is closed Disconnect switch 1 phase C is open Disconnect switch 1 phase C bad status is detected (discrepancy between the 89/a and 89/b contacts) Disconnect switch 1 phase C intermediate status is detected (transition from one position to another) Disconnect switch 1 bad status is detected on any pole Switch 1 tagged so manual trip and close is blocked Switch 1 not tagged Switch 1 status manually substituted to closed Switch 1 status manually substituted to open Switch 1 control interlocking is bypassed manually Switch 1 control interlocking is not bypassed manually
	SWITCH 2 to 8	Same set of operands as shown for SWITCH 1
ELEMENT: Synchrocheck	SYNC1 DEAD S OP SYNC1 DEAD S DPO SYNC1 SYNC OP SYNC1 SYNC DPO SYNC1 CLS OP SYNC1 CLS DPO SYNC1 V1 ABOVE MIN SYNC1 V1 BELOW MAX SYNC1 V2 ABOVE MIN SYNC1 V2 BELOW MAX SYNC1 S-CLOSE OP SYNC1 S-CLOSE OP DPO SYNC1 S-CLOSE ARMD	Synchrocheck 1 dead source has operated Synchrocheck 1 dead source has dropped out Synchrocheck 1 in synchronization has operated Synchrocheck 1 in synchronization has dropped out Synchrocheck 1 close has operated Synchrocheck 1 close has dropped out Synchrocheck 1 V1 is above the minimum live voltage Synchrocheck 1 V1 is below the maximum dead voltage Synchrocheck 1 V2 is above the minimum live voltage Synchrocheck 1 V2 is below the maximum dead voltage Synchrocheck 1 S-CLOSE has operated Synchrocheck 1 S-CLOSE has dropped out Synchrocheck 1 S-CLOSE has been armed
	SYNC 2 to 4	Same set of operands as shown for SYNC 1
ELEMENT: Teleprotection channel tests	TELEPRO CH1 FAIL TELEPRO CH2 FAIL TELEPRO CH1 ID FAIL TELEPRO CH2 ID FAIL TELEPRO CH1 CRC FAIL TELEPRO CH2 CRC FAIL TELEPRO CH1 PKT LOST TELEPRO CH2 PKT LOST	Channel 1 failed Channel 2 failed The ID check for a peer relay on channel 1 has failed The ID check for a peer relay on channel 2 has failed CRC detected packet corruption on channel 1 CRC detected packet corruption on channel 2 CRC detected lost packet on channel 1 CRC detected lost packet on channel 2
ELEMENT: Teleprotection inputs/outputs	TELEPRO INPUT 1-1 On ↓ TELEPRO INPUT 1-16 On TELEPRO INPUT 2-1 On ↓ TELEPRO INPUT 2-16 On	Flag is set, Logic =1 ↓ Flag is set, Logic =1 Flag is set, Logic =1 ↓ Flag is set, Logic =1
ELEMENT: Thermal overload protection	THERMAL PROT 1 PKP THERMAL PROT 1 OP	Thermal overload protection 1 picked up Thermal overload protection 1 operated
	THERMAL PROT 2	Same set of operands as shown for THERMAL PROT 1
ELEMENT: Trip bus	TRIP BUS 1 PKP TRIP BUS 1 OP	Asserted when the trip bus 1 element picks up Asserted when the trip bus 1 element operates



Operand type	Operand syntax	Operand description
	TRIP BUS 2 to 6	Same set of operands as shown for TRIP BUS 1
ELEMENT: Underfrequency	UNDERFREQ 1 PKP UNDERFREQ 1 OP UNDERFREQ 1 DPO	Underfrequency 1 has picked up Underfrequency 1 has operated Underfrequency 1 has dropped out
	UNDERFREQ 2 to 6	Same set of operands as shown for UNDERFREQ 1
ELEMENT: Volts per hertz	VOLT PER HERTZ 1 PKP VOLT PER HERTZ 1 OP VOLT PER HERTZ 1 DPO	The volts per hertz element 1 has picked up The volts per hertz element 1 has operated The volts per hertz element 1 has dropped out
	VOLT PER HERTZ 2	Same set of operands as VOLT PER HERTZ 1
ELEMENT: Transformer aging factor	XFMR AGING FCTR PKP XFMR AGING FCTR OP XFMR AGING FCTR DPO	The transformer aging factor element has picked up The transformer aging factor element has operated The transformer aging factor element has dropped out
ELEMENT: Hottest-spot temperature	XFMR HST-SPOT °C PKP XFMR HST-SPOT °C OP XFMR HST-SPOT °C DPO	The hottest-spot temperature element has picked up The hottest-spot temperature element has operated The hottest-spot temperature element has dropped out
ELEMENT: Transformer loss of life	XFMR LIFE LOST PKP XFMR LIFE LOST OP	The transformer loss of life element has picked up The transformer loss of life element has operated
ELEMENT: Transformer percent differential	XFMR PCNT DIFF PKP A XFMR PCNT DIFF PKP B XFMR PCNT DIFF PKP C XFMR PCNT DIFF 2ND A XFMR PCNT DIFF 2ND B XFMR PCNT DIFF 2ND C XFMR PCNT DIFF 5TH A XFMR PCNT DIFF 5TH B XFMR PCNT DIFF 5TH C XFMR PCNT DIFF OP XFMR PCNT DIFF OP A XFMR PCNT DIFF OP B XFMR PCNT DIFF OP C XFMR PCNT DIFF SAT A XFMR PCNT DIFF SAT B XFMR PCNT DIFF SAT C XFMR PCNT DIFF DIR A XFMR PCNT DIFF DIR B XFMR PCNT DIFF DIR C XFMR PCNT DIFF WARN	Transformer percent differential protection has picked up in phase A Transformer percent differential protection has picked up in phase B Transformer percent differential protection has picked up in phase C The 2nd harmonic of transformer percent differential has blocked phase A The 2nd harmonic of transformer percent differential has blocked phase B The 2nd harmonic of transformer percent differential has blocked phase C The 5th harmonic of transformer percent differential has blocked phase A The 5th harmonic of transformer percent differential has blocked phase B The 5th harmonic of transformer percent differential has blocked phase C At least one phase of transformer percent differential has operated Phase A of transformer percent differential has operated Phase B of transformer percent differential has operated Phase C of transformer percent differential has operated Transformer percent differential SAT flag has triggered on phase A Transformer percent differential SAT flag has triggered on phase B Transformer percent differential SAT flag has triggered on phase C Transformer percent differential DIR flag has triggered on phase A Transformer percent differential DIR flag has triggered on phase B Transformer percent differential DIR flag has triggered on phase C Transformer percent differential current has exceeded 0.5xPKP for 10s
FIXED OPERANDS	Off	Logic = 0. Does nothing and can be used as a delimiter in an equation list; used as 'Disable' by other features.
	On	Logic = 1. Can be used as a test setting.
INPUTS/OUTPUTS: Contact inputs	Cont Ip 1 On Cont Ip 2 On ↓ Cont Ip 1 Off Cont Ip 2 Off ↓ Cont Ip 120 On Cont Ip 120 Off	(does not appear unless ordered) (does not appear unless ordered) ↓ (does not appear unless ordered) (does not appear unless ordered) ↓ (does not appear unless ordered) (does not appear unless ordered)
INPUTS/OUTPUTS: Contact outputs, current (from detector on form-A output only)	Cont Op 1 IOn Cont Op 2 IOn ↓ Cont Op 72 IOn	(does not appear unless ordered) (does not appear unless ordered) ↓ (does not appear unless ordered)
INPUTS/OUTPUTS: Contact outputs, voltage (from detector on form-A output only)	Cont Op 1 VOn Cont Op 2 VOn ↓ Cont Op 72 VOn	(does not appear unless ordered) (does not appear unless ordered) ↓ (does not appear unless ordered)
	Cont Op 1 VOff Cont Op 2 VOff ↓ Cont Op 72 VOff	(does not appear unless ordered) (does not appear unless ordered) ↓ (does not appear unless ordered)

Operand type	Operand syntax	Operand description
INPUTS/OUTPUTS: Direct inputs	DIRECT INPUT 1 On ↓ DIRECT INPUT 32 On	Flag is set, logic=1 ↓ Flag is set, logic=1
INPUTS/OUTPUTS: RxGOOSE DPS	RxG DPS 1 BAD RxG DPS 1 INTERM  RxG DPS 1 OFF RxG DPS 1 ON  RxG DPS 2 to 5	Asserted while the RxGOOSE double-point status input is in the bad state Asserted while the RxGOOSE double-point status input is in the intermediate state Asserted while the RxGOOSE double-point status input is off Asserted while the RxGOOSE double-point status input is on  Same set of operands as per RxG DPS 1
INPUTS/OUTPUTS: RxGOOSE Booleans	RxG Bool 1 On RxG Bool 2 On RxG Bool 3 On ↓ RxG Bool 256 On	Flag is set, logic=1 Flag is set, logic=1 Flag is set, logic=1 ↓ Flag is set, logic=1
INPUTS/OUTPUTS: Virtual inputs	Virt Ip 1 On Virt Ip 2 On Virt Ip 3 On ↓ Virt Ip 64 On	Flag is set, logic=1 Flag is set, logic=1 Flag is set, logic=1 ↓ Flag is set, logic=1
INPUTS/OUTPUTS: Virtual outputs	Virt Op 1 On Virt Op 2 On Virt Op 3 On ↓ Virt Op 96 On	Flag is set, logic=1 Flag is set, logic=1 Flag is set, logic=1 ↓ Flag is set, logic=1
LED INDICATORS: Enhanced and basic front panels	LED IN SERVICE LED TROUBLE LED TEST MODE LED TRIP LED ALARM LED PICKUP LED VOLTAGE LED CURRENT LED FREQUENCY LED OTHER LED PHASE A LED PHASE B LED PHASE C LED NEUTRAL/GROUND	Asserted when the front panel IN SERVICE LED is on Asserted when the front panel TROUBLE LED is on Asserted when the front panel TEST MODE LED is on Asserted when the front panel TRIP LED is on Asserted when the front panel ALARM LED is on Asserted when an element picks up and to turn PICKUP LED on Asserted when a voltage element involved and to turn VOLTAGE LED on Asserted when a current element involved and to turn CURRENT LED on Asserted when a frequency element involved and to turn FREQUENCY LED on Asserted when a composite element involved and to turn OTHER LED on Asserted when phase A involved and to turn PHASE A LED on Asserted when phase B involved and to turn PHASE B LED on Asserted when phase C involved and to turn PHASE C LED on Asserted when a neutral or ground element involved and to turn NEUTRAL/GROUND LED on
LED INDICATORS: Graphical front panel	LED IN SERVICE LED TROUBLE LED TEST MODE LED TRIP LED ALARM LED PICKUP  LED VOLTAGE  LED CURRENT  LED FREQUENCY  LED OTHER  LED PHASE A LED PHASE B LED PHASE C LED NEUTRAL/GROUND	Asserted when the front panel IN SERVICE LED is on Asserted when the front panel TROUBLE LED is on Asserted when the front panel TEST MODE LED is on Asserted when the front panel TRIP LED is on Asserted when the front panel ALARM LED is on Asserted when an element picks up and to turn Event Cause LED 1 on by default Asserted when a voltage element involved and to turn Event Cause LED 2 on by default Asserted when a current element involved and to turn Event Cause LED 3 on by default Asserted when a frequency element involved and to turn Event Cause LED 4 on by default Asserted when a composite element involved and to turn Event Cause LED 5 on by default Asserted when phase A involved and to turn Event Cause LED 6 on by default Asserted when phase B involved and to turn Event Cause LED 7 on by default Asserted when phase C involved and to turn Event Cause LED 8 on by default Asserted when a neutral or ground element involved and to turn Event Cause LED 9 on by default
LED INDICATORS: LED test	LED TEST IN PROGRESS	An LED test has been initiated and has not finished

Operand type	Operand syntax	Operand description
LED INDICATORS: User-programmable LEDs Enhanced and basic front panels	LED USER 1	Asserted when user-programmable LED 1 is on
	LED USER 2 to 48	The operand above is available for user-programmable LEDs 2 through 48
LED INDICATORS: User-programmable LEDs Graphical front panel	EVENT CAUSE LED 1	Asserted when event cause LED 1 is on
	EVENT CAUSE LED 2 to 9	Same operand as EVENT CAUSE LED 1
PASSWORD SECURITY	ACCESS LOC SETG OFF ACCESS LOC SETG ON ACCESS LOC CMND OFF ACCESS LOC CMND ON ACCESS REM SETG OFF ACCESS REM SETG ON ACCESS REM CMND OFF ACCESS REM CMND ON UNAUTHORIZED ACCESS	Asserted when local setting access is disabled Asserted when local setting access is enabled Asserted when local command access is disabled Asserted when local command access is enabled Asserted when remote setting access is disabled Asserted when remote setting access is enabled Asserted when remote command access is disabled Asserted when remote command access is enabled Asserted when a password entry fails while accessing a password protected level of the G30
RxGOOSE	RxGOOSE 1 On ↓ RxGOOSE 64 On	Flag is set, logic=1 ↓ Flag is set, logic=1
	RxGOOSE 1 Off ↓ RxGOOSE 64 Off	Flag is set, logic=1 ↓ Flag is set, logic=1
	<RxGOOSE Boolean1 ID> On <RxGOOSE DPS1 ID> Bad <RxGOOSE DPS1 ID> Interm <RxGOOSE DPS1 ID> Off <RxGOOSE DPS1 ID> On RxGOOSE INVLD ON RxGOOSE QUES ON	Replace bracketed text with RxGOOSE Boolean1 status of "true" Replace bracketed text with RxGOOSE DPS1 status of "bad-state" Replace bracketed text with RxGOOSE DPS1 status is "intermediate-state" Replace bracketed text with RxGOOSE DPS1 status is "off" Replace bracketed text with RxGOOSE DPS1 status is "on" One or more Rx GOOSE Inputs are received with Invalid quality One or more Rx GOOSE Inputs are received with questionable quality
		RxGOOSE INVLD ON and RxGOOSE QUES ON operands have no dependency with test mode or simulation mode. The operands are set when any of the RxGOOSE Inputs received with Invalid or questionable quality.
RESETTING	RESET OP RESET OP (COMMS) RESET OP (OPERAND)  RESET OP (PUSHBUTTON) RESET ANCTR OP RESET ANCTR OP(OPRD)  RESET ANCTR OP(MNUL)	Reset command is operated (set by all three operands below) Communications source of the reset command Operand (assigned in the <b>INPUTS/OUTPUTS ⇌ ⚙ RESETTING</b> menu) source of the reset command Reset key (pushbutton) source of the reset command Reset annunciator command is operated (set by any operands below) Reset operand (assigned in <b>INPUTS/OUTPUTS ⇌ ⚙ RESETTING ANNUNCIATOR</b> menu) source of the reset annunciator command Reset manual (pushbutton or EnerVista software) source of the reset annunciator command

Operand type	Operand syntax	Operand description
SELF-DIAGNOSTICS (See Relay Self-tests descriptions in Chapter 7: Commands and Targets)	ANY MAJOR ERROR ANY MINOR ERROR ANY SELF-TESTS BATTERY FAIL  CLOCK UNSYNCHRONIZED DIRECT DEVICE OFF DIRECT RING BREAK EQUIPMENT MISMATCH FLEXLOGIC ERR TOKEN IRIG-B FAILURE LATCHING OUT ERROR MAINTENANCE ALERT FIRST ETHERNET FAIL PROCESS BUS FAILURE PTP FAILURE RxGOOSE OFF RRTD COMM FAIL SECOND ETHERNET FAIL THIRD ETHERNET FAIL SNTP FAILURE SYSTEM EXCEPTION TEMP MONITOR UNIT NOT PROGRAMMED  SETTING CHANGED	Any of the major self-test errors generated (major error) Any of the minor self-test errors generated (minor error) Any self-test errors generated (generic, any error) The battery is weak or not functioning. Replace as outlined in the Maintenance chapter. Relay is not synchronized to the international time standard A direct device is configured but not connected The Direct I/O settings is for a connection that is not in a ring The configuration of modules does not match the stored order code A FlexLogic equation is incorrect "Bad IRIG-B Signal" self-test. See Chapter 7: Commands and Targets. A difference is detected between the desired and actual latch contact state A subset of the minor self-test errors generated, see Chapter 7 Link failure detected. See description in Chapter 7: Commands and Targets. See description in Chapter 7: Commands and Targets "Bad PTP Signal" self-test as described in Chapter 7 One or more GOOSE messages are not being received See description in Chapter 7: Commands and Targets See description in Chapter 7: Commands and Targets See description in Chapter 7: Commands and Targets See description in Chapter 7: Commands and Targets SNTP server is not responding See description in Chapter 7: Commands and Targets Monitors ambient temperature and maximum operating temperature The product <b>SETUP &gt; INSTALLATION &gt; RELAYS SETTINGS</b> setting is not programmed Any device settings changed over any available interface; operand is asserted for at least one second and then self-reset
SIMULATION	TxGOOSE SIM ON RxGOOSE SIM ON	Sim bit enabled in all Tx GOOSE GOOSE messages with Sim bit set are accepted
TEMPERATURE MONITOR	TEMP MONITOR	Asserted while the ambient temperature is greater than the maximum operating temperature (80°C)
USER-PROGRAMMABLE PUSHBUTTONS	PUSHBUTTON 1 ON PUSHBUTTON 1 OFF ANY PB ON	Pushbutton number 1 is in the "On" position Pushbutton number 1 is in the "Off" position Any of 12 pushbuttons is in the "On" position
	PUSHBUTTON 2 to 6, 12, or 16 depending on front panel	Same set of operands as PUSHBUTTON 1

Some operands can be re-named. These are the names of the breakers in the breaker control feature, the ID (identification) of contact inputs and outputs, the ID of virtual inputs, and the ID of virtual outputs. If the user changes the default name or ID of any of these operands, the assigned name appears in the relay list of operands. The default names are shown in the FlexLogic operands table.

The characteristics of the logic gates are tabulated in the following table, and the operators available in FlexLogic are listed in the FlexLogic operators table.

**Table 5-23: FlexLogic gate characteristics**

Gates	Number of inputs	Output is '1' (= ON) if...
NOT	1	input is '0'
OR	2 to 16	any input is '1'
AND	2 to 16	all inputs are '1'
NOR	2 to 16	all inputs are '0'
NAND	2 to 16	any input is '0'
XOR	2	only one input is '1'



Table 5-24: FlexLogic operators

Type	Syntax	Description	Notes
Editor	INSERT	Insert a parameter in an equation list	
	DELETE	Delete a parameter from an equation list	
End	END	The first END encountered signifies the last entry in the list of processed FlexLogic parameters	
One-shot	POSITIVE ONE SHOT	One shot that responds to a positive going edge	A 'one shot' refers to a single input gate that generates a pulse in response to an edge on the input. The output from a 'one shot' is True (positive) for only one pass through the FlexLogic equation. There is a maximum of 64 'one shots.'
	NEGATIVE ONE SHOT	One shot that responds to a negative going edge	
	DUAL ONE SHOT	One shot that responds to both the positive and negative going edges	
Logic gate	NOT	Logical NOT	Operates on the previous parameter
	OR(2) ↓	2 input OR gate	Operates on the 2 previous parameters
	OR(16)	16 input OR gate	Operates on the 16 previous parameters
	AND(2) ↓	2 input AND gate	Operates on the 2 previous parameters
	AND(16)	16 input AND gate	Operates on the 16 previous parameters
	NOR(2) ↓	2 input NOR gate	Operates on the 2 previous parameters
	NOR(16)	16 input NOR gate	Operates on the 16 previous parameters
	NAND(2) ↓	2 input NAND gate	Operates on the 2 previous parameters
	NAND(16)	16 input NAND gate	Operates on the 16 previous parameters
XOR(2)	2 input Exclusive OR gate	Operates on the 2 previous parameters	
	LATCH (S,R)	Latch (set, reset): reset-dominant	The parameter preceding LATCH(S,R) is the reset input. The parameter preceding the reset input is the set input.
Timer	TIMER 1 ↓	Timer set with FlexLogic timer 1 settings	The timer is started by the preceding parameter. The output of the timer is TIMER #.
	TIMER 32	Timer set with FlexLogic timer 32 settings	
Assign virtual output	= Virt Op 1 ↓ = Virt Op 96	Assigns previous FlexLogic operand to virtual output 1 ↓ Assigns previous FlexLogic operand to virtual output 96	The virtual output is set by the preceding parameter

5

### 5.6.2 FlexLogic rules

When forming a FlexLogic equation, the sequence in the linear array of parameters must follow these general rules:

1. Operands must precede the operator that uses the operands as inputs.
2. Operators have only one output. The output of an operator must be used to create a virtual output if it is to be used as an input to two or more operators.
3. Assigning the output of an operator to a virtual output terminates the equation.
4. A timer operator (for example, "TIMER 1") or virtual output assignment (for example, "= Virt Op 1") can be used once only. If this rule is broken, a syntax error is declared.

### 5.6.3 FlexLogic evaluation

Each equation is evaluated in the ascending order in which the parameters have been entered.





FlexLogic provides built-in latches that by definition have a memory action, remaining in the set state after the set input has been asserted. These built-in latches are reset dominant, meaning that if logical "1" is applied to both set and reset entries simultaneously, then the output of the latch is logical "0." However, they are volatile, meaning that they reset upon removal of control power.

When making changes to FlexLogic entries in the settings, all FlexLogic equations are re-compiled whenever any new FlexLogic entry value is entered, and as a result of the re-compile all latches are reset automatically.

To implement FlexLogic using a graphical user interface, see the FlexLogic Design and Monitoring using Engineer section in the previous chapter.

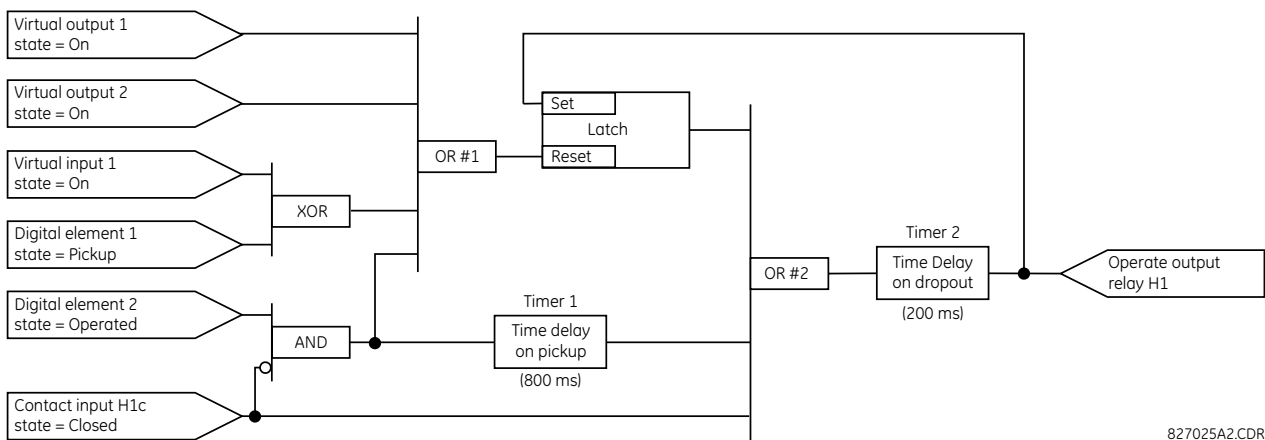
### 5.6.4 FlexLogic example

This section provides an example of logic implementation for a typical application. The sequence of steps is important to minimize the work to develop the relay settings. Note that the example in the following figure demonstrates the procedure, not to solve a specific application situation.

Note that there is also a graphical interface with which to draw logic and populate FlexLogic equation entries. See the Engineer content at the end of the previous chapter.

In the example, it is assumed that logic has already been programmed to produce virtual outputs 1 and 2, and is only a part of the full set of equations used. When using FlexLogic, it is important to make a note of each virtual output used; a virtual output designation (1 to 96) can be assigned only once.

Figure 5-90: Logic example



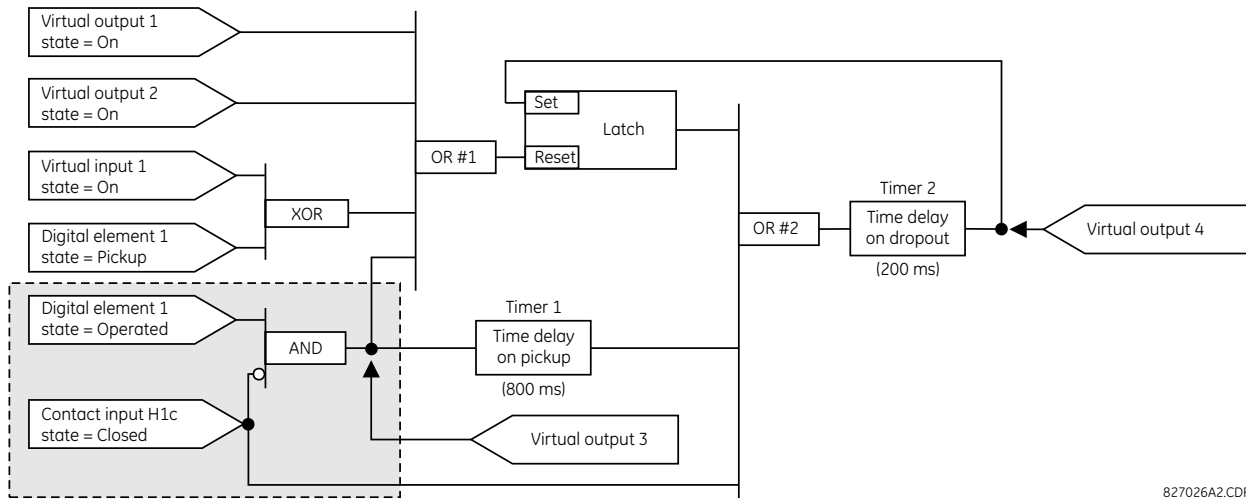
1. Inspect the example logic diagram to determine if the required logic can be implemented with the FlexLogic operators. If this is not possible, the logic must be altered until this condition is satisfied. Once done, count the inputs to each gate to verify that the number of inputs does not exceed the FlexLogic limits, which is unlikely but possible. If the number of inputs is too high, subdivide the inputs into multiple gates to produce an equivalent. For example, if 25 inputs to an AND gate are required, connect Inputs 1 through 16 to AND(16), 17 through 25 to AND(9), and the outputs from these two gates to AND(2).

Inspect each operator between the initial operands and final virtual outputs to determine if the output from the operator is used as an input to more than one following operator. If so, the operator output must be assigned as a virtual output.

For the example shown, the output of the AND gate is used as an input to both OR#1 and Timer 1, and must therefore be made a virtual output and assigned the next available number (that is, Virtual Output 3). The final output must also be assigned to a virtual output as virtual output 4, which is programmed in the contact output section to operate relay H1 (that is, contact output H1).

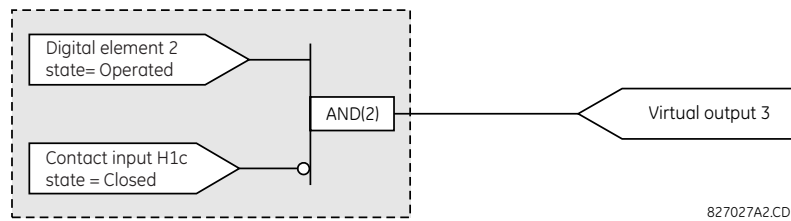
Therefore, the required logic can be implemented with two FlexLogic equations with outputs of virtual output 3 and virtual output 4, shown as follows.

Figure 5-91: Logic example with virtual outputs



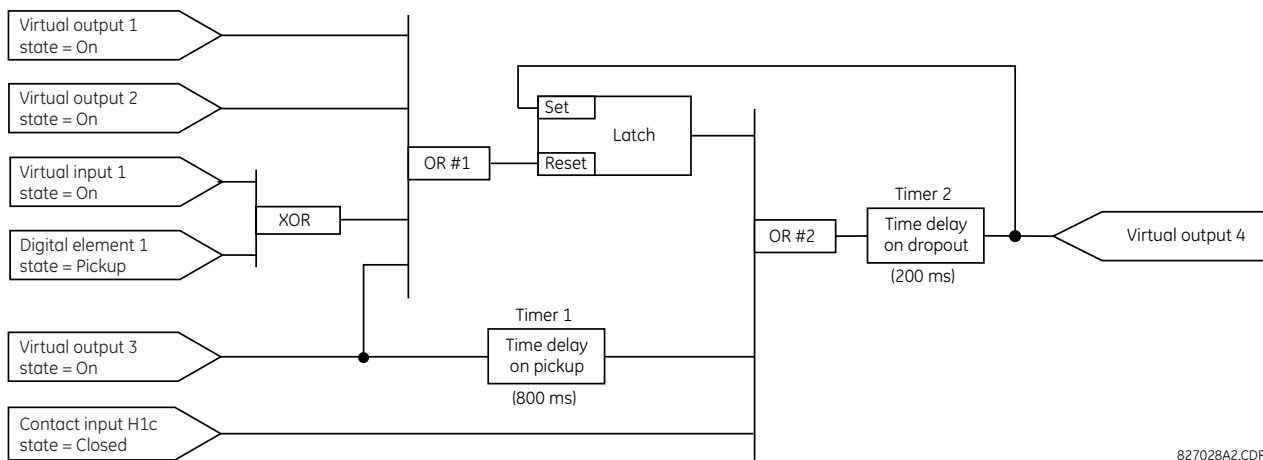
- Prepare a logic diagram for the equation to produce virtual output 3, as this output is used as an operand in the virtual output 4 equation (create the equation for every output that is used as an operand first, so that when these operands are required they already have been evaluated and assigned to a specific virtual output). The logic for virtual output 3 is shown as follows with the final output assigned.

Figure 5-92: Logic for virtual output 3



- Prepare a logic diagram for virtual output 4, replacing the logic ahead of virtual output 3 with a symbol identified as virtual output 3, shown as follows.

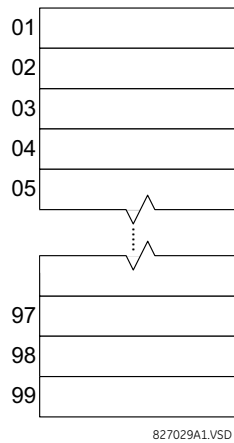
Figure 5-93: Logic for virtual output 4



- Program the FlexLogic equation for virtual output 3 by translating the logic into available FlexLogic parameters. The equation is formed one parameter at a time until the required logic is complete. It is generally easier to start at the output end of the equation and work back towards the input, as shown in the following steps. It is also recommended

to list operator inputs from bottom to top. For demonstration, the final outputs are arbitrarily identified as parameter 99, and each preceding parameter decremented by one in turn. Until accustomed to using FlexLogic, it is suggested that a worksheet with a series of cells marked with the arbitrary parameter numbers be prepared shown as follows.

Figure 5-94: FlexLogic worksheet



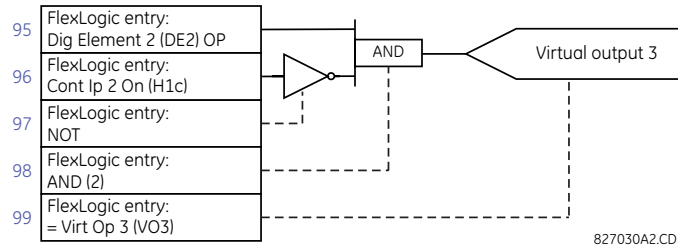
5. Following the procedure outlined, start with parameter 99, as follows:
  - 99: The final output of the equation is virtual output 3, which is created by the operator "= Virt Op n". This parameter is therefore "= Virt Op 3".
  - 98: The gate preceding the output is an AND, which in this case requires two inputs. The operator for this gate is a 2-input AND so the parameter is "AND(2)". Note that FlexLogic rules require that the number of inputs to most types of operators must be specified to identify the operands for the gate. As the 2-input AND operates on the two operands preceding it, these inputs must be specified, starting with the lower.
  - 97: This lower input to the AND gate must be passed through an inverter (the NOT operator) so the next parameter is "NOT". The NOT operator acts upon the operand immediately preceding it, so specify the inverter input next.
  - 96: The input to the NOT gate is to be contact input H1c. The ON state of a contact input can be programmed to be set when the contact is either open or closed. Assume for this example that the state is to be ON for a closed contact. The operand is therefore "Cont Ip H1c On".
  - 95: The last step in the procedure is to specify the upper input to the AND gate, the operated state of digital element 2. This operand is "DIG ELEM 2 OP".

Writing the parameters in numerical order forms the equation for virtual output 3:

```
[95] DIG ELEM 2 OP
[96] Cont Ip H1c on
[97] NOT
[98] AND(2)
[99] = Virt op 3
```

It is now possible to check that this selection of parameters produces the required logic by converting the set of parameters into a logic diagram. The result of this process is shown in the figure, which is compared to the logic for virtual output 3 diagram as a check.

Figure 5-95: FlexLogic equation for virtual output 3



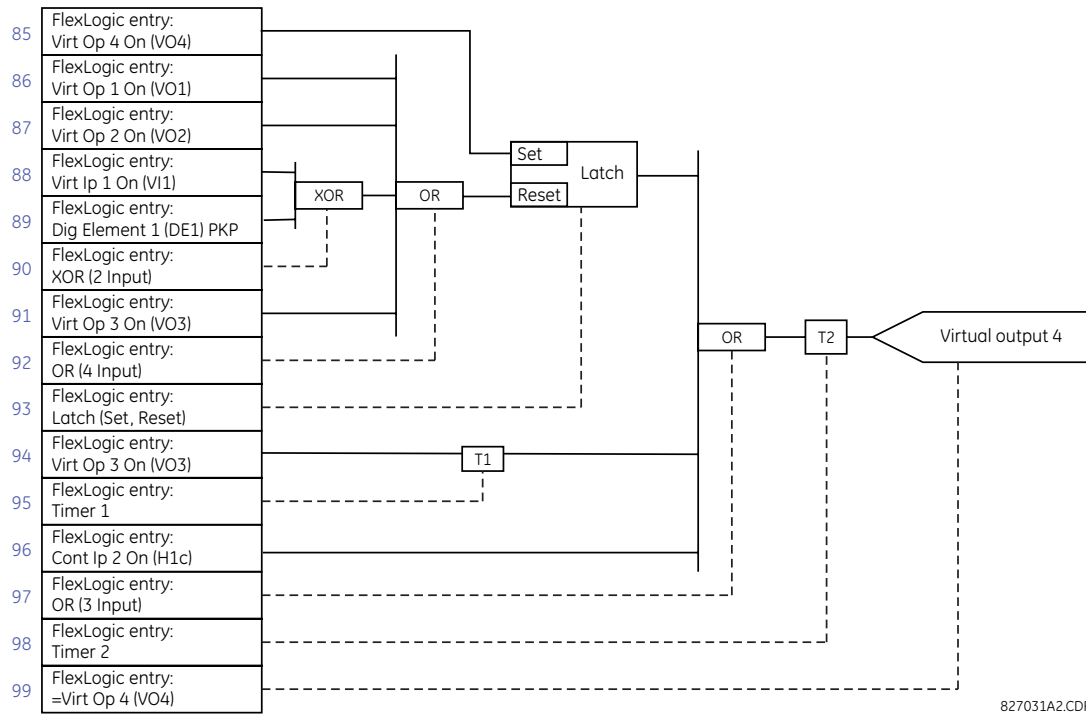
6. Repeating the process described for virtual output 3, select the FlexLogic parameters for Virtual Output 4.
  - 99: The final output of the equation is virtual output 4, which is parameter “= Virt Op 4”.
  - 98: The operator preceding the output is timer 2, which is operand “TIMER 2”. Note that the settings required for the timer are established in the timer programming section.
  - 97: The operator preceding timer 2 is OR #2, a 3-input OR, which is parameter “OR(3)”.
  - 96: The lowest input to OR #2 is operand “Cont Ip H1c On”.
  - 95: The center input to OR #2 is operand “TIMER 1”.
  - 94: The input to timer 1 is operand “Virt Op 3 On”.
  - 93: The upper input to OR #2 is operand “LATCH (S,R)”.
  - 92: There are two inputs to a latch, and the input immediately preceding the latch reset is OR #1, a 4-input OR, which is parameter “OR(4)”.
  - 91: The lowest input to OR #1 is operand “Virt Op 3 On”.
  - 90: The input just above the lowest input to OR #1 is operand “XOR(2)”.
  - 89: The lower input to the XOR is operand “DIG ELEM 1 PKP”.
  - 88: The upper input to the XOR is operand “Virt Ip 1 On”.
  - 87: The input just below the upper input to OR #1 is operand “Virt Op 2 On”.
  - 86: The upper input to OR #1 is operand “Virt Op 1 On”.
  - 85: The last parameter is used to set the latch, and is operand “Virt Op 4 On”.

The equation for virtual output 4 is:

```
[85] Virt Op 4 On
[86] Virt Op 1 On
[87] Virt Op 2 On
[88] Virt Ip 1 On
[89] DIG ELEM 1 PKP
[90] XOR(2)
[91] Virt Op 3 On
[92] OR(4)
[93] LATCH (S,R)
[94] Virt Op 3 On
[95] TIMER 1
[96] Cont Ip H1c On
[97] OR(3)
[98] TIMER 2
[99] = Virt Op 4
```

Now check that the selection of parameters produce the required logic by converting the set of parameters into a logic diagram. The result is shown in the figure, which is compared to the logic for virtual output 4 diagram as a check.

Figure 5-96: FlexLogic equation for virtual output 4



7. Now write the complete FlexLogic expression required to implement the logic, making an effort to assemble the equation in an order where Virtual Outputs that are used as inputs to operators are created before needed. In cases where a lot of processing is required to perform logic, this can be difficult to achieve, but in most cases does not cause problems as all logic is calculated at least four times per power frequency cycle. The possibility of a problem caused by sequential processing emphasizes the necessity to test the performance of FlexLogic before it is placed in service.

In the following equation, virtual output 3 is used as an input to both latch 1 and timer 1 as arranged in the following order:

```

DIG ELEM 2 OP
Cont Ip H1c On
NOT
AND(2)
= Virt Op 3
Virt Op 4 On
Virt Op 1 On
Virt Op 2 On
Virt Ip 1 On
DIG ELEM 1 PKP
XOR(2)
Virt Op 3 On
OR(4)
LATCH (S,R)
Virt Op 3 On
TIMER 1
Cont Ip H1c On
OR(3)
TIMER 2
= Virt Op 4
END

```

In this expression, the virtual output 4 input to the four-input OR is listed before it is created. This is typical of a form of feedback, in this case, used to create a seal-in effect with the latch, and is correct.

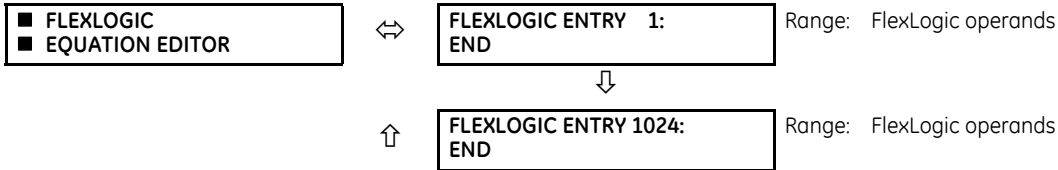
8. Always test the logic after it is loaded into the relay, in the same way as has been used in the past. Testing can be simplified by placing an "END" operator within the overall set of FlexLogic equations. The equations are evaluated up

to the first "END" operator.

The "On" and "Off" operands can be placed in an equation to establish a known set of conditions for test purposes, and the "INSERT" and "DELETE" commands can be used to modify equations.

### 5.6.5 FlexLogic equation editor

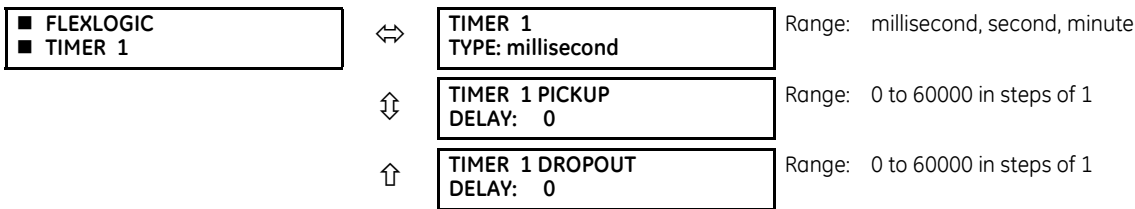
SETTINGS ⇨ FLEXLOGIC ⇨ FLEXLOGIC EQUATION EDITOR



There are 1,024 FlexLogic entries available, numbered from 1 to 1024, with default END entry settings. If a "Disabled" element is selected as a FlexLogic entry, the associated state flag is never set to '1'. Press the +/- key when editing FlexLogic equations to quickly scan through the major parameter types.

### 5.6.6 FlexLogic timers

SETTINGS ⇨ FLEXLOGIC ⇨ FLEXLOGIC TIMERS ⇨ FLEXLOGIC TIMER 1(32)



There are 32 identical FlexLogic timers available. These timers are used as operators for FlexLogic equations.

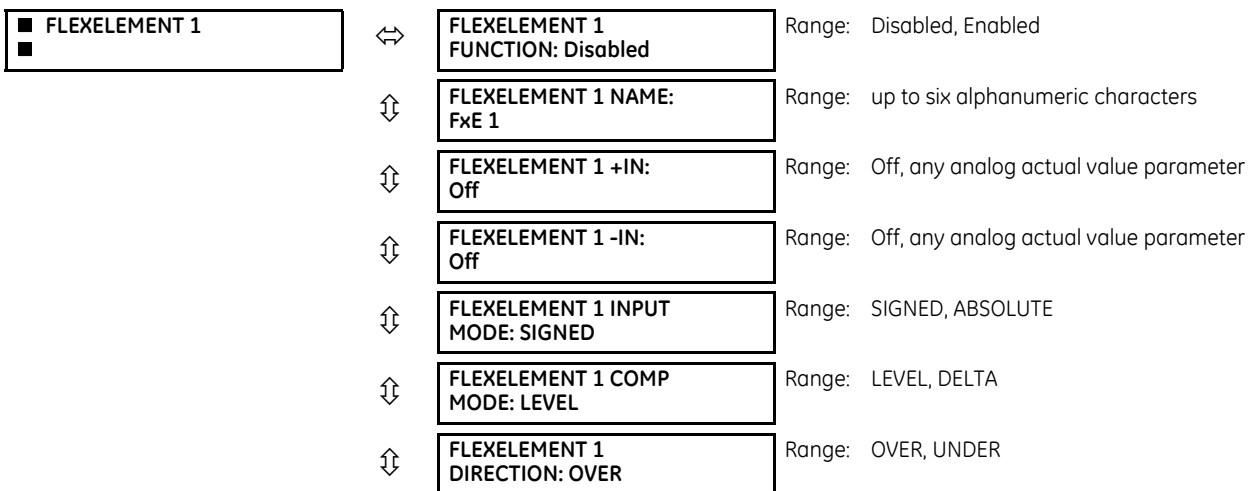
**TIMER 1 TYPE** — Selects the time measurement unit.

**TIMER 1 PICKUP DELAY** — Sets the time delay to pickup. If a pickup delay is not required, set this function to "0."

**TIMER 1 DROPOUT DELAY** — Sets the time delay to dropout. If a dropout delay is not required, set this function to "0."

### 5.6.7 FlexElements

SETTINGS ⇨ FLEXLOGIC ⇨ FLEXELEMENTS ⇨ FLEXELEMENT 1(16)



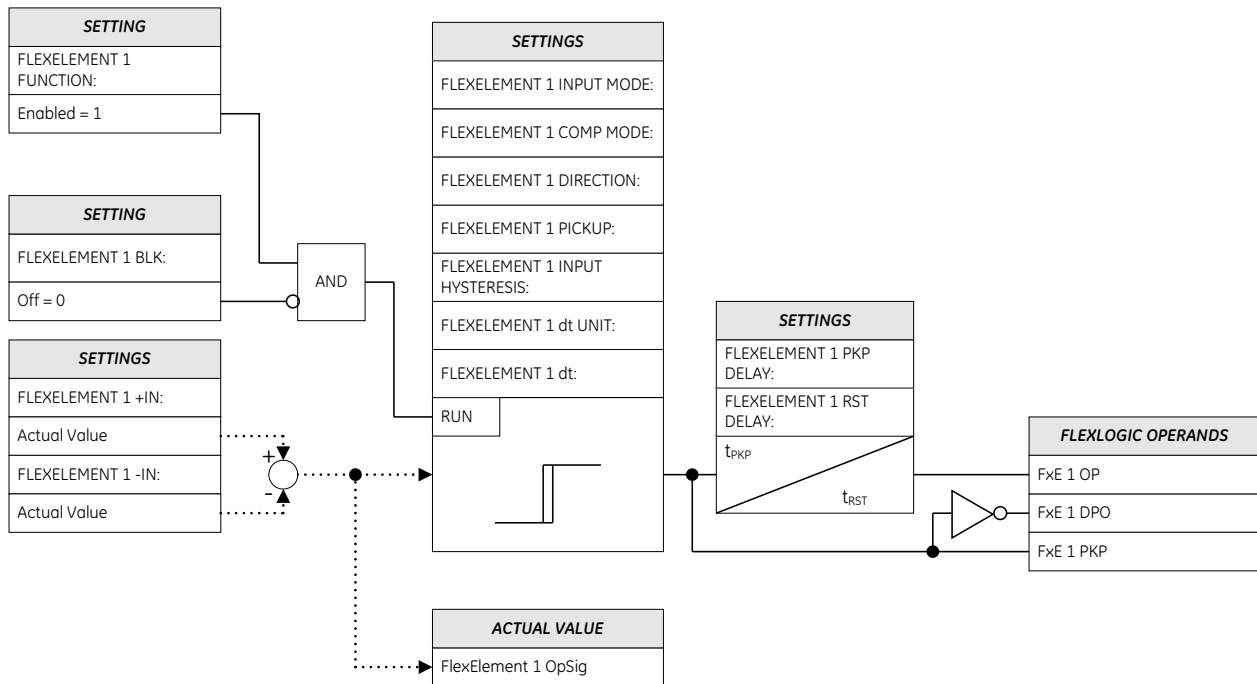
⇕	<b>FLEXELEMENT 1 PICKUP: 1.000 pu</b>	Range: -90.000 to 90.000 pu in steps of 0.001
⇕	<b>FLEXELEMENT 1 HYSTERESIS: 3.0%</b>	Range: 0.1 to 50.0% in steps of 0.1
⇕	<b>FLEXELEMENT 1 dt UNIT: Milliseconds</b>	Range: Milliseconds, Seconds, Minutes
⇕	<b>FLEXELEMENT 1 dt: 20</b>	Range: 20 to 86400 in steps of 1
⇕	<b>FLEXELEMENT 1 PKP DELAY: 0.000 s</b>	Range: 0.000 to 65.535 s in steps of 0.001
⇕	<b>FLEXELEMENT 1 RST DELAY: 0.000 s</b>	Range: 0.000 to 65.535 s in steps of 0.001
⇕	<b>FLEXELEMENT 1 BLK: Off</b>	Range: FlexLogic operand
⇕	<b>FLEXELEMENT 1 TARGET: Self-reset</b>	Range: Self-reset, Disabled, Latched
⇕	<b>FLEXELEMENT 1 EVENTS: Disabled</b>	Range: Disabled, Enabled

A FlexElement is a universal comparator used to monitor any analog actual value calculated by the relay or a net difference of any two analog actual values of the same type. The effective operating signal can be treated as a signed number or its absolute value can be used.

FlexElements run every half power cycle (every four protection passes).

The element can be programmed to respond either to a signal level or to a rate-of-change (delta) over a pre-defined period of time. The output operand is asserted when the operating signal is higher than a threshold or lower than a threshold, as per your choice.

Figure 5-97: FlexElement logic



842004A4.CDR

**FLEXELEMENT 1 +IN** — This setting specifies the first (non-inverted) input to the FlexElement. Zero is assumed as the input if this setting is set to “Off.” For proper operation of the element, at least one input must be selected. Otherwise, the element does not assert its output operands.

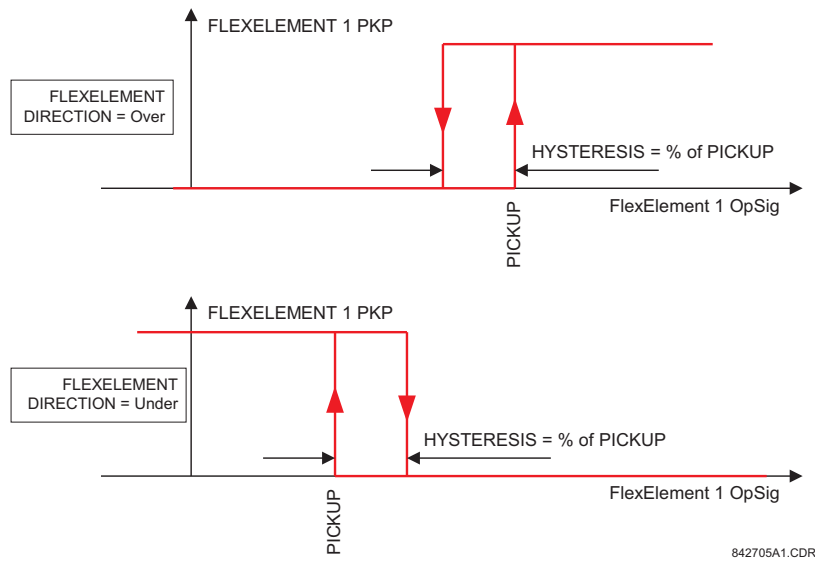
**FLEXELEMENT 1 -IN** — Specifies the second (inverted) input to the FlexElement. Zero is assumed as the input if this setting is set to “Off.” For proper operation of the element, at least one input must be selected. Otherwise, the element does not assert its output operands. This input is used to invert the signal if needed for convenience, or to make the element respond to a differential signal, such as for a top-bottom oil temperature differential alarm. The element does not operate if the two input signals are of different types, for example if one tries to use active power and phase angle to build the effective operating signal.

The element responds directly to the differential signal if the **FLEXELEMENT 1 INPUT MODE** setting is set to “Signed.” The element responds to the absolute value of the differential signal if this setting is set to “Absolute.” Sample applications for the “Absolute” setting include monitoring the angular difference between two phasors with a symmetrical limit angle in both directions, monitoring power regardless of its direction, or monitoring a trend.

The element responds directly to its operating signal—as defined by the **FLEXELEMENT 1 +IN**, **FLEXELEMENT 1 -IN** and **FLEXELEMENT 1 INPUT MODE** settings—if the **FLEXELEMENT 1 COMP MODE** setting is set to “Level.” The element responds to the rate of change of its operating signal if the **FLEXELEMENT 1 COMP MODE** setting is set to “Delta.” In this case, the **FLEXELEMENT 1 dt UNIT** and **FLEXELEMENT 1 dt** settings specify how the rate of change is derived.

**FLEXELEMENT 1 DIRECTION** — Enables the relay to respond to either high or low values of the operating signal. The following figure explains the application of the **FLEXELEMENT 1 DIRECTION**, **FLEXELEMENT 1 PICKUP**, and **FLEXELEMENT 1 HYSTERESIS** settings.

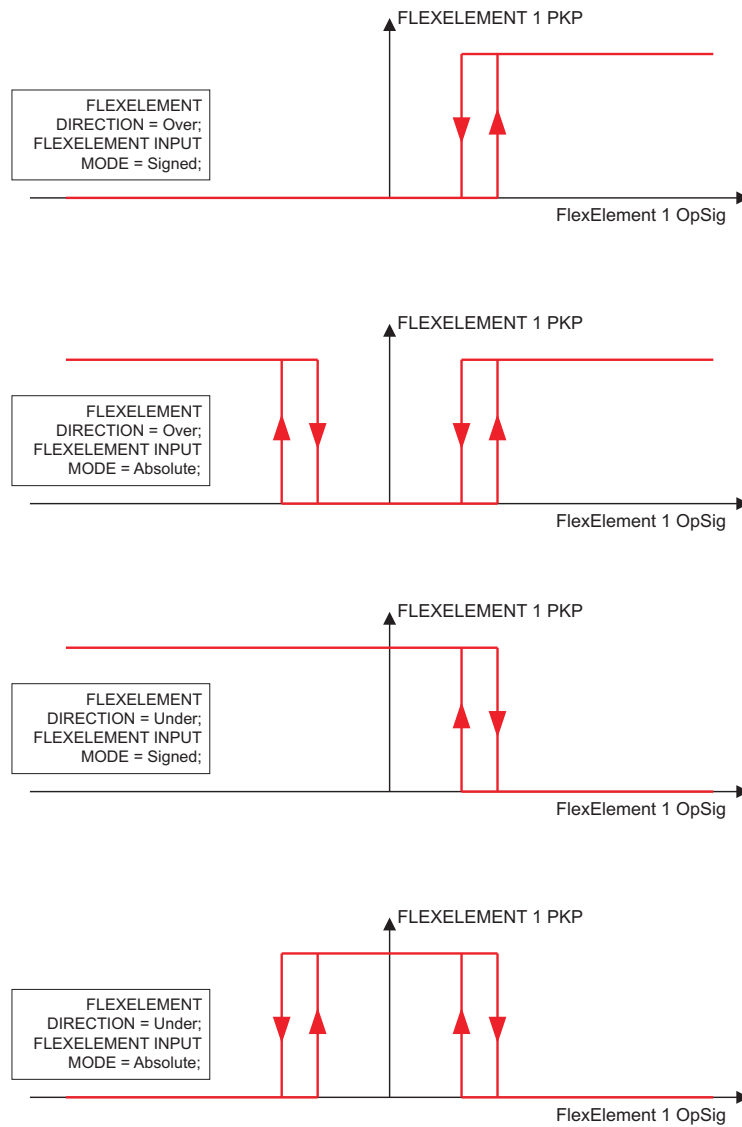
Figure 5-98: FlexElement direction, pickup, and hysteresis



In conjunction with the **FLEXELEMENT 1 INPUT MODE** setting, the element can be programmed to provide two extra characteristics, as shown in the following figure.



Figure 5-99: FlexElement input mode setting



842706A2.CDR

**FLEXELEMENT 1 PICKUP** — This setting specifies the operating threshold for the effective operating signal of the element. If set to “Over,” the element picks up when the operating signal exceeds the **FLEXELEMENT 1 PICKUP** value. If set to “Under,” the element picks up when the operating signal falls below the **FLEXELEMENT 1 PICKUP** value.

**FLEXELEMENT 1 HYSTERESIS** — This setting controls the element dropout. Notice that both the operating signal and the pickup threshold can be negative, facilitating applications such as reverse power alarm protection. The FlexElement can be programmed to work with all analog actual values measured by the relay. The **FLEXELEMENT 1 PICKUP** setting is entered in per-unit values using the following definitions of the base units.

Table 5-25: FlexElement base units

Unit	Description
BREAKER ACC ARCING AMPS (Brk X Acc Arc Amp A, B, and C)	BASE = 2000 kA <sup>2</sup> × cycle
BREAKER ARCING AMPS (Brk X Arc Amp A, B, and C)	BASE = 1 kA <sup>2</sup> × cycle

Unit	Description
DCmA	BASE = maximum value of the <b>DCMA INPUT MAX</b> setting for the two transducers configured under the +IN and -IN inputs
DELTA TIME	BASE = 1 $\mu$ s
FREQUENCY	$f_{BASE} = 1$ Hz
FREQUENCY RATE OF CHANGE	$df/dt_{BASE} = 1$ Hz/s
PHASE ANGLE	$\phi_{BASE} = 360$ degrees (see the UR angle referencing convention)
POWER FACTOR	$PF_{BASE} = 1.00$
RTDs	BASE = 100°C
SENSITIVE DIR POWER (Sns Dir Power)	$P_{BASE} = \text{maximum value of } 3 \times V_{BASE} \times I_{BASE}$ for the +IN and -IN inputs of the sources configured for the sensitive power directional element(s).
SOURCE CURRENT	$I_{BASE} = \text{maximum nominal primary RMS value of the +IN and -IN inputs}$
SOURCE ENERGY (Positive and Negative Watthours, Positive and Negative Varhours)	$E_{BASE} = 10000$ MWh or MVAh, respectively
SOURCE POWER	$P_{BASE} = \text{maximum value of } V_{BASE} \times I_{BASE}$ for the +IN and -IN inputs
SOURCE THD & HARMONICS	BASE = 1%
SOURCE VOLTAGE	$V_{BASE} = \text{maximum nominal primary RMS value of the +IN and -IN inputs}$
STATOR GROUND 3RD HARMONIC VOLTAGES (Stator Gnd Vn/V0 3rd)	$V_{BASE} = \text{Primary auxiliary voltage of the STATOR GROUND SOURCE}$
SYNCHROCHECK (Max Delta Volts)	$V_{BASE} = \text{maximum primary RMS value of all the sources related to the +IN and -IN inputs}$
VOLTS PER HERTZ	BASE = 1.00 pu
XFMR DIFFERENTIAL CURRENT (Xfmr Iad, Ibd, and Icd Mag)	$I_{BASE} = \text{maximum primary RMS value of the +IN and -IN inputs}$ (CT primary for source currents, and transformer reference primary current for transformer differential currents)
XFMR DIFFERENTIAL HARMONIC CONTENT (Xfmr Harm2 Iad, Ibd, and Icd Mag) (Xfmr Harm5 Iad, Ibd, and Icd Mag)	BASE = 10%
XFMR RESTRAINING CURRENT (Xfmr Iar, Ibr, and Icr Mag)	$I_{BASE} = \text{maximum primary RMS value of the +IN and -IN inputs}$ (CT primary for source currents, and transformer reference primary current for transformer differential currents)

**FLEXELEMENT 1 HYSTERESIS** — This setting defines the pickup-dropout relation of the element by specifying the width of the hysteresis loop as a percentage of the pickup value as shown in the FlexElement Direction, Pickup, and Hysteresis diagram.

**FLEXELEMENT 1 dt UNIT** — Specifies the time unit for the setting **FLEXELEMENT 1 dt**. This setting is applicable only if **FLEXELEMENT 1 COMP MODE** is set to "Delta."

**FLEXELEMENT 1 dt** — Specifies duration of the time interval for the rate of change mode of operation. This setting is applicable only if **FLEXELEMENT 1 COMP MODE** is set to "Delta."

**FLEXELEMENT 1 PKP DELAY** — Specifies the pickup delay of the element.

**FLEXELEMENT 1 RST DELAY** — Specifies the reset delay of the element.

### 5.6.8 Non-volatile latches

SETTINGS ⇨ FLEXLOGIC ⇨ NON-VOLATILE LATCHES ⇨ LATCH 1(16)

<input checked="" type="checkbox"/> LATCH 1 <input type="checkbox"/>	⇔	LATCH 1 FUNCTION: Disabled	Range: Disabled, Enabled
	⇕	LATCH 1 ID: NV Latch 1	Range: up to 20 alphanumeric characters
	⇕	LATCH 1 TYPE: Reset Dominant	Range: Reset Dominant, Set Dominant



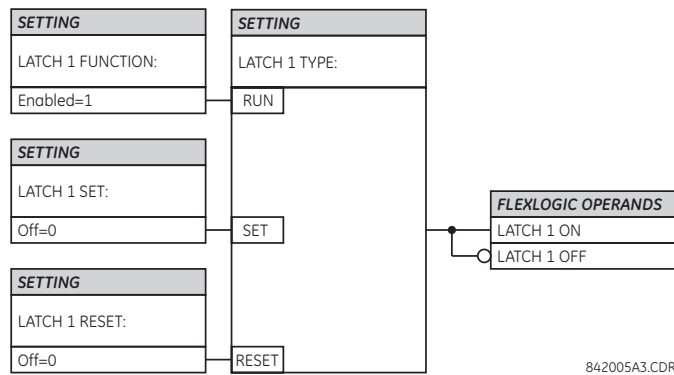
The non-volatile latches provide a permanent logical flag that is stored safely and do not reset upon restart after the relay is powered down. Typical applications include sustaining operator commands or permanently blocking relay functions, such as Autorecloser, until a deliberate interface action resets the latch.

**LATCH 1 TYPE** — This setting characterizes Latch 1 to be Set- or Reset-dominant.

**LATCH 1 SET** — If asserted, the specified FlexLogic operands 'sets' Latch 1.

**LATCH 1 RESET** — If asserted, the specified FlexLogic operand 'resets' Latch 1.

Figure 5-100: Non-volatile latch operation table (N = 1 to 16) and logic



842005A3.CDR

Latch n type	Latch n set	Latch n reset	Latch n on	Latch n off
Reset Dominant	ON	OFF	ON	OFF
	OFF	OFF	Previous State	Previous State
	ON	ON	OFF	ON
	OFF	ON	OFF	ON
Set Dominant	ON	OFF	ON	OFF
	ON	ON	ON	OFF
	OFF	OFF	Previous State	Previous State
	OFF	ON	OFF	ON

## 5.7 Grouped elements

### 5.7.1 Overview

Each protection element can be assigned up to six sets of settings with designations 1 to 6. The performance of these elements is defined by the active setting group at a given time. Multiple setting groups allow the user to conveniently change protection settings for different operating situations (for example, altered power system configuration or season of the year). The active setting group can be preset or selected in the **SETTING GROUPS** menu (see the Control Elements section later in this chapter). See also the Introduction to Elements section at the beginning of this chapter.

### 5.7.2 Setting group 1

SETTINGS ⇄ GROUPED ELEMENTS ⇄ SETTING GROUP 1(6)

<div style="border: 1px solid black; padding: 2px;">                 ■ SETTING GROUP 1                  ■             </div>	↔	<div style="border: 1px solid black; padding: 2px;">                 ■ TRANSFORMER                  ■             </div>	See below
	⇅	<div style="border: 1px solid black; padding: 2px;">                 ■ PHASE CURRENT                  ■             </div>	See page 5-210
	⇅	<div style="border: 1px solid black; padding: 2px;">                 ■ NEUTRAL CURRENT                  ■             </div>	See page 5-222
	⇅	<div style="border: 1px solid black; padding: 2px;">                 ■ GROUND CURRENT                  ■             </div>	See page 5-230
	⇅	<div style="border: 1px solid black; padding: 2px;">                 ■ NEGATIVE SEQUENCE                  ■ CURRENT             </div>	See page 5-237
	⇅	<div style="border: 1px solid black; padding: 2px;">                 ■ GENERATOR                  ■ UNBALANCE             </div>	See page 5-241
	⇅	<div style="border: 1px solid black; padding: 2px;">                 ■ SPLIT PHASE                  ■             </div>	See page 5-243
	⇅	<div style="border: 1px solid black; padding: 2px;">                 ■ VOLTAGE ELEMENTS                  ■             </div>	See page 5-247
	⇅	<div style="border: 1px solid black; padding: 2px;">                 ■ LOSS OF EXCITATION                  ■             </div>	See page 5-259
	⇅	<div style="border: 1px solid black; padding: 2px;">                 ■ ACCIDENTAL ENERGIZATION                  ■             </div>	See page 5-261
	⇅	<div style="border: 1px solid black; padding: 2px;">                 ■ POWER                  ■             </div>	See page 5-263
	↑	<div style="border: 1px solid black; padding: 2px;">                 ■ STATOR                  ■ GROUND             </div>	See page 5-266

Each of the six setting group menus is identical. Setting group 1 (the default active group) is active automatically when no other group is active.

If the device incorrectly switches to group 1 after power cycling, upgrade the firmware to version 7.31 or later to correct this issue.

## 5.7.3 Transformer

### 5.7.3.1 Menu

SETTINGS ⇒ GROUPED ELEMENTS ⇒ SETTING GROUP 1(6) ⇒ TRANSFORMER

<input checked="" type="checkbox"/> TRANSFORMER <input checked="" type="checkbox"/>	↔	<input checked="" type="checkbox"/> PERCENT <input checked="" type="checkbox"/> DIFFERENTIAL	See below
	↕	<input checked="" type="checkbox"/> HOTTEST-SPOT <input checked="" type="checkbox"/> TEMPERATURE	See page 5-208
	↕	<input checked="" type="checkbox"/> AGING FACTOR <input checked="" type="checkbox"/>	See page 5-208
	↑	<input checked="" type="checkbox"/> LOSS OF LIFE <input checked="" type="checkbox"/>	See page 5-209

This menu contains the settings for the transformer differential elements and the transformer thermal elements.

The thermal elements include hottest-spot temperature, aging factor and loss of life. The computation of these elements follows IEEE standards C57.91-1995: "IEEE Guide for Loading Mineral-Oil-Immersed Transformers" and C57.96-1989: "IEEE Guide for Loading Dry-Type Distribution Transformers". The computations are based on transformer loading conditions, ambient temperature, and the entered transformer data.

### 5.7.3.2 Transformer percent differential (ANSI 87GT)

SETTINGS ⇒ GROUPED ELEMENTS ⇒ SETTING GROUP 1(6) ⇒ TRANSFORMER ⇒ PERCENT DIFFERENTIAL

<input checked="" type="checkbox"/> PERCENT <input checked="" type="checkbox"/> DIFFERENTIAL	↔	PERCENT DIFFERENTIAL FUNCTION: Disabled	Range: Disabled, Enabled
	↕	PERCENT DIFFERENTIAL PICKUP: 0.100 pu	Range: 0.050 to 1.000 pu in steps of 0.001
	↕	PERCENT DIFFERENTIAL SLOPE 1: 25%	Range: 15 to 100% in steps of 1
	↕	PERCENT DIFFERENTIAL BREAK 1: 2.000 pu	Range: 1.000 to 2.000 pu in steps of 0.001
	↕	PERCENT DIFFERENTIAL BREAK 2: 8.000 pu	Range: 2.000 to 30.000 pu in steps of 0.001
	↕	PERCENT DIFFERENTIAL SLOPE 2: 90%	Range: 50 to 100% in steps of 1
	↕	INRUSH INHIBIT FUNCTION: Adapt. 2nd	Range: Disabled, Adapt. 2nd, Trad. 2nd
	↕	INRUSH INHIBIT MODE: Per phase	Range: Per phase, 2-out-of-3, Average, 1-out-of-3
	↕	INRUSH INHIBIT LEVEL: 20.0% fo	Range: 1.0 to 40.0% of fo in steps of 0.1
	↕	OVEREXCITN INHIBIT FUNCTION: Disabled	Range: Disabled, 5th
	↕	OVEREXCITN INHIBIT LEVEL: 10.0% fo	Range: 1.0 to 40.0% of fo in steps of 0.1
	↕	PERCENT DIFF BLOCK: Off	Range: FlexLogic operand
	↕	PERCENT DIFFERENTIAL TARGET: Self-reset	Range: Self-reset, Latched, Disabled

PERCENT DIFFERENTIAL EVENTS: Disabled Range: Disabled, Enabled

The calculation of differential ( $I_d$ ) and restraint ( $I_r$ ) currents for the purposes of the percent differential element is described by the following block diagram, where “ $\Sigma$ ” has as its output the vector sum of inputs, and “max” has as its output the input of maximum magnitude; these calculations are performed for each phase.

The differential current is calculated as a vector sum of currents from all windings after magnitude and angle compensation.

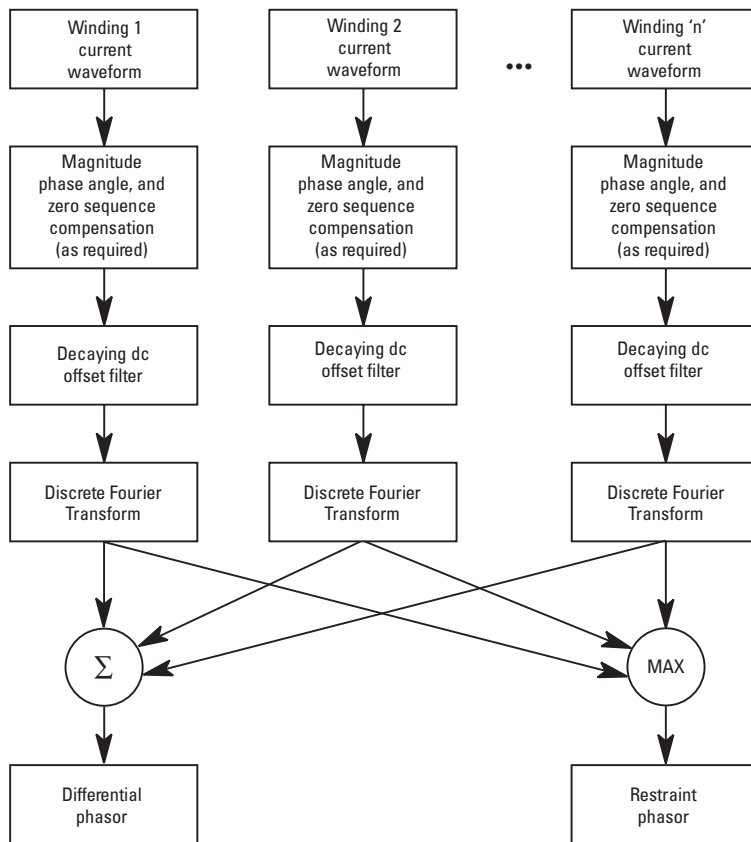
$$I_d = \vec{I}_{1\_comp} + \vec{I}_{2\_comp} \tag{Eq. 5-29}$$

The restraint current is calculated as a maximum of the same internally compensated currents.

$$I_r = K \times \max(|\vec{I}_{1\_comp}|, |\vec{I}_{2\_comp}|) \tag{Eq. 5-30}$$

The element operates if  $I_d > PKP$  and  $I_d / I_r > K$ , where PKP represents a percent differential pickup setting and K is a restraint factor defined by the relays settings Slope 1, Slope 2, and a transition area between breakpoint 1 and breakpoint 2 settings.

Figure 5-101: Percent differential calculations



828714A1.CDR

The G30 percent differential element is based on a configurable dual-breakpoint / dual-slope differential restraint characteristic. The purpose of this characteristic is to define the differential/restraint ratio for the transformer winding currents at different loading and fault conditions to securely distinguish between external and internal faults. Increased differential current can occur under load or external fault conditions due to current unbalance between transformer windings and can be caused by the following:

- Inherent CT inaccuracies

- Onload tap changer operation: it adjusts the transformer ratio and consequently the winding currents
- CT saturation

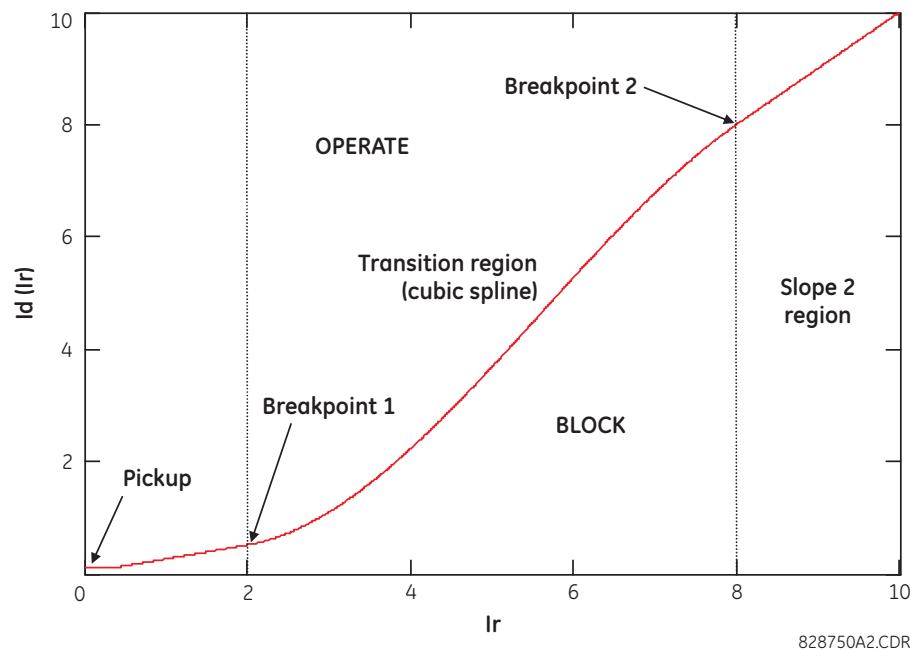
To provide higher security during CT saturation conditions and to ease CT requirements, the G30 incorporates a dedicated CT saturation detection mechanism. The G30 CT saturation detector can detect saturation happening after approximately 3 ms from fault inception. In case CT saturation is detected, the percent differential is blocked instantly and relies further on the directional element in case fault evolved from external to internal to operate without any delays. Directional element supervision is not applied if no CT saturation is detected.

The saturation detector is an integral part of the transformer percent differential element. It has no settings but uses some of the differential characteristic parameters. The flags indicating CT saturation are available on a per-phase basis as FlexLogic operands.

The directional principle is also an integral part of the transformer percent differential element and has no associated settings. The directional element dynamically identifies what appears to be the faulted circuit and compares its current angle with that of the sum of the remaining currents of the protected zone. The element declares a transformer internal fault if the angle is less than 90°. Directional indicating flags signal operation on a per-phase basis and are available as FlexLogic operands.

For more information on CT saturation detection and directional principle, see the Theory of Operation chapter.

**Figure 5-102: Percent differential operating characteristic**



Settings are defined as follows.

**PERCENT DIFFERENTIAL PICKUP** — This setting defines the minimum differential current required for operation. It is chosen, based on the amount of differential current that can be seen under normal operating conditions. Two factors can create differential current during the normal transformer operation: errors due to CT inaccuracies and current variation due to onload tap changer operation. A setting of 0.1 to 0.3 is recommended (the factory default is 0.1 pu).

**PERCENT DIFFERENTIAL SLOPE 1** — Defines the percentage bias for the restraining currents below the lower breakpoint (BREAK 1). This setting determines the sensitivity of the relay for low current internal faults. The setting must be set high enough to cope with the spurious differential current resulting from inaccuracy of the CTs operating in their linear mode, that is, in load conditions and during distant external faults.

**PERCENT DIFFERENTIAL BREAK 1** — Defines the lower breakpoint of the dual-slope differential operating characteristic. This setting needs to be set above the maximum load current and can be moved to the AC current under which all the CTs are guaranteed to transform without saturation. This includes the effect of DC components and/or residual magnetism. The latter can be as high as 80% of the nominal flux, effectively reducing the CT capabilities by the factor of five. When adjusting this setting, it must be kept in mind that the restraining signal is created as the maximum of all the input currents.

**PERCENT DIFFERENTIAL BREAK 2** — Defines the higher breakpoint of the dual-slope operating characteristic. Set BREAK 2 setting below the fault current that is likely to saturate the weakest CT feeding the relay. When adjusting this setting, keep in mind that the restraining signal is created as the maximum of all the input currents.

**PERCENT DIFFERENTIAL SLOPE 2** — Defines the percentage bias for the restraining currents above the higher breakpoint (BREAK 2). This setting affects stability of the relay for heavy external faults. Traditionally, the value chosen for this setting needs to be high enough to accommodate the spurious differential current resulting from saturation of the CTs during heavy external faults. This requirement can be considerably relaxed in favor of sensitivity and speed of operation as the relay detects CT saturation and upon detection applies the directional principle to prevent maloperation. When adjusting this setting, keep in mind that the restraining signal is created as the maximum of all the input currents.

**INRUSH INHIBIT FUNCTION** — This setting provides a choice for 2nd harmonic differential protection blocking during magnetizing inrush conditions. Two choices are available: "Adapt. 2nd" – adaptive 2nd harmonic, and "Trad. 2nd" – traditional 2nd harmonic blocking. The adaptive 2nd harmonic restraint responds to magnitudes and phase angles of the 2nd harmonic and the fundamental frequency component. The traditional 2nd harmonic restraint responds to the ratio of magnitudes of the 2nd harmonic and fundamental frequency components. If low second harmonic ratios during magnetizing inrush conditions are not expected, set the relay to a traditional way of restraining.

**INRUSH INHIBIT MODE** — This setting specifies mode of blocking on magnetizing inrush conditions. Modern transformers can produce small 2nd harmonic ratios during inrush conditions. This can result in undesired tripping of the protected transformer. Reducing the 2nd harmonic inhibit threshold can jeopardize dependability and speed of protection. The 2nd harmonic ratio, if low, causes problems in one phase only. This can be utilized as a means to ensure security by applying cross-phase blocking rather than lowering the inrush inhibit threshold.

If set to "Per phase," the relay performs inrush inhibit individually in each phase. If used on modern transformers, combine this setting with adaptive 2nd harmonic function.

If set to "2-out-of-3," the relay checks 2nd harmonic level in all three phases individually. If any two phases establish a blocking condition, the remaining phase is restrained automatically. Note that in this mode, the "2-out-of-3" logic is used only if all three phases of differential currents exceed the hardcoded cutoff level of 0.04 pu, otherwise, "1-out-of-3" logic is used.

If set to "Average," the relay first calculates the average 2nd harmonic ratio, then applies the inrush threshold to the calculated average. This mode works only in conjunction with the traditional 2nd harmonic function.

If set to "1-out-of-3," the relay checks 2nd harmonic level in all three phases individually. If any phase establishes a blocking condition, differential protection in all three phases are blocked. This mode is also known as "cross-blocking" method.

**INRUSH INHIBIT LEVEL** — Specifies the level of 2nd harmonic component in the transformer magnetizing inrush current above which the percent differential element is inhibited from operating. The value of the **INRUSH INHIBIT MODE** setting must be taken into account when programming this value. The **INRUSH INHIBIT LEVEL** is set typically to 20%.

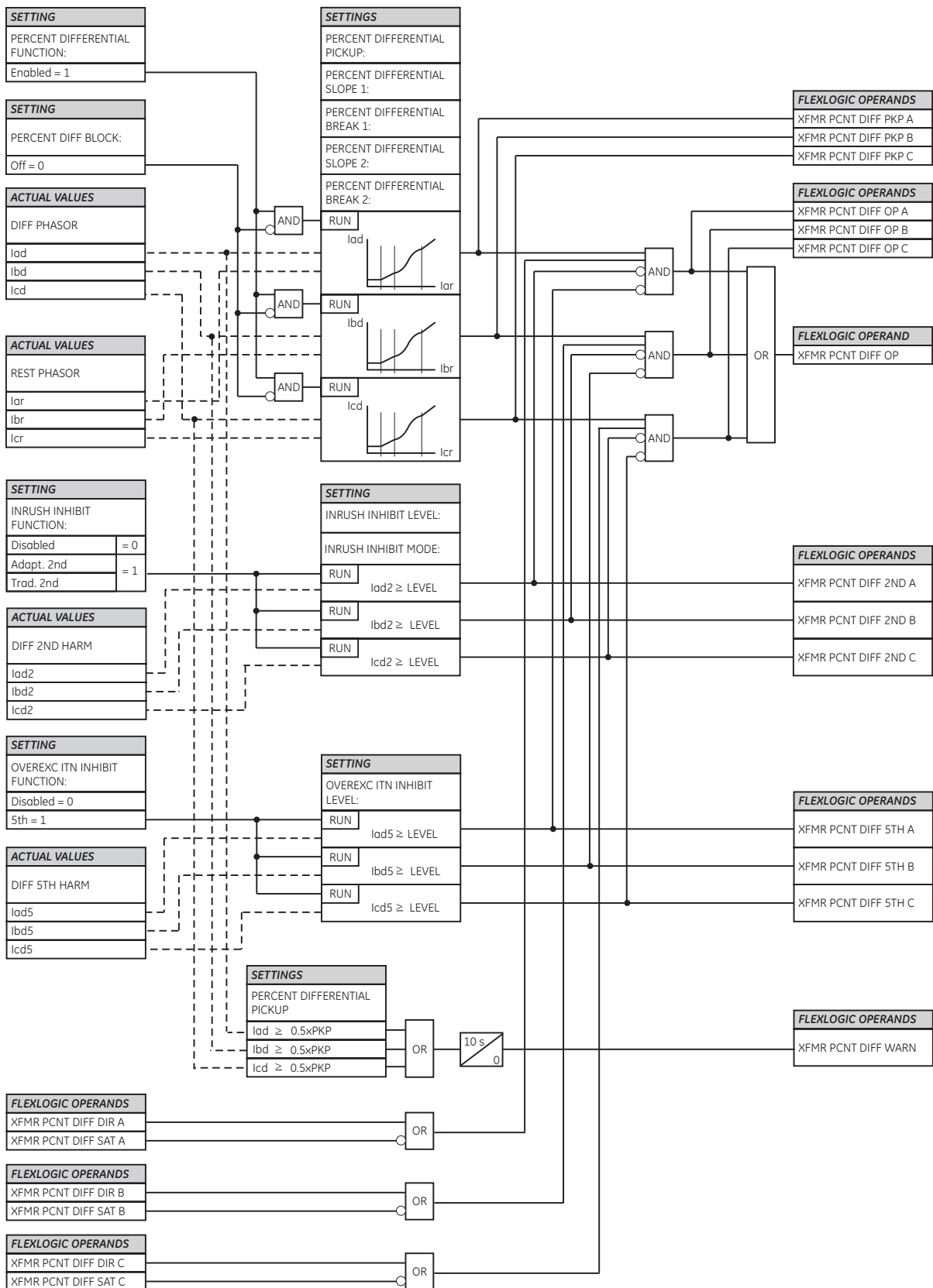
**OVEREXCITATION INHIBIT MODE** — An overexcitation condition resulting from an increased volts/hertz ratio poses a danger to the protected transformer, hence the volts/hertz protection. A given transformer can, however, tolerate an overfluxing condition for a limited time, as the danger is associated with thermal processes in the core. Instantaneous tripping of the transformer from the differential protection is not desirable. The relay uses a traditional 5th harmonic ratio for inhibiting its differential function during overexcitation conditions.

**OVEREXCITATION INHIBIT LEVEL** — This setting is provided to block the differential protection during overexcitation. When the 5th harmonic level exceeds the specified setting (5th harmonic ratio) the differential element is blocked. The overexcitation inhibit works on a per-phase basis.

The relay produces three FlexLogic operands that can be used for testing or for special applications, such as building custom logic (1-out-of-3) or supervising some protection functions (ground time overcurrent, for example) from the 2nd harmonic inhibit.



Figure 5-103: Percent differential logic



### 5.7.3.3 Hottest-spot temperature

SETTINGS ⇨ GROUPED ELEMENTS ⇨ SETTING GROUP 1(6) ⇨ TRANSFORMER ⇨ HOTTEST-SPOT TEMPERATURE

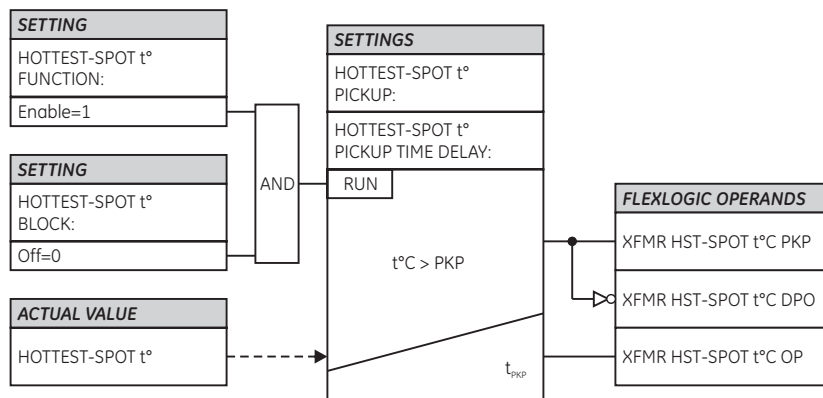
<div style="border: 1px solid black; padding: 2px;"> <span style="display: inline-block; width: 10px; height: 10px; background-color: black; margin-right: 5px;"></span> <b>HOTTEST-SPOT TEMPERATURE</b> </div>	↔	<div style="border: 1px solid black; padding: 2px;"> <b>XFMR HST FUNCTION:</b>                      Disabled                 </div>	Range: Disabled, Enabled
	↕	<div style="border: 1px solid black; padding: 2px;"> <b>XFMR HST PICKUP:</b>                      140°C                 </div>	Range: 50 to 300°C in steps of 1
	↕	<div style="border: 1px solid black; padding: 2px;"> <b>XFMR HST DELAY:</b>                      1 min.                 </div>	Range: 0 to 30000 min. in steps of 1
	↕	<div style="border: 1px solid black; padding: 2px;"> <b>XFMR HST BLOCK:</b>                      Off                 </div>	Range: FlexLogic operand
	↑	<div style="border: 1px solid black; padding: 2px;"> <b>XFMR HST TARGET:</b>                      Self-Reset                 </div>	Range: Self-reset, Latched, Disabled

The Hottest-Spot Temperature element provides a mechanism to detect abnormal winding hottest-spot temperatures inside the transformer. It can be set to alarm or trip in cases where the computed hottest-spot temperature is above the pickup threshold for a user-specified time (considered as transformer overheating).

**XFMR HST PICKUP** — Enter the hottest-spot temperature required for operation of the element. Base this setting on the maximum permissible hottest-spot temperature under emergency transformer loading conditions and maximum ambient temperature.

**XFMR HST DELAY** — Enter an appropriate time delay before operation of the element.

Figure 5-104: Transformer hottest-spot temperature logic



828731A4.cdr

### 5.7.3.4 Aging factor

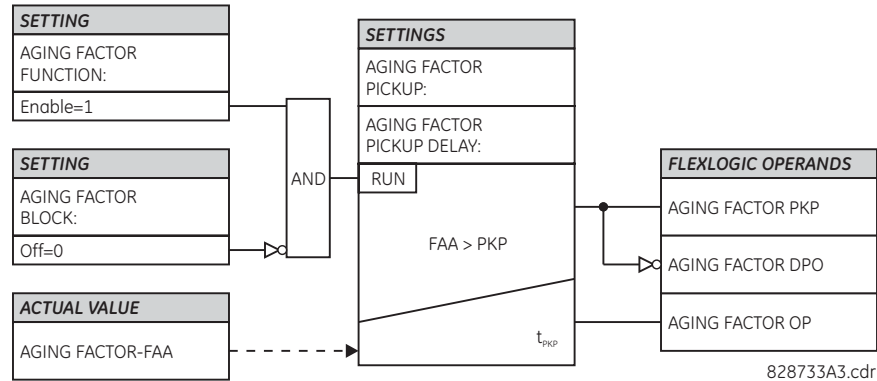
SETTINGS ⇨ GROUPED ELEMENTS ⇨ SETTING GROUP 1(6) ⇨ TRANSFORMER ⇨ AGING FACTOR

<div style="border: 1px solid black; padding: 2px;"> <span style="display: inline-block; width: 10px; height: 10px; background-color: black; margin-right: 5px;"></span> <b>AGING FACTOR</b> </div>	↔	<div style="border: 1px solid black; padding: 2px;"> <b>AGING FACTOR FUNCTION:</b> Disabled                 </div>	Range: Disabled, Enabled
	↕	<div style="border: 1px solid black; padding: 2px;"> <b>AGING FACTOR PICKUP:</b>                      2.0 pu                 </div>	Range: 1.1 to 10.0 pu in steps of 0.1
	↕	<div style="border: 1px solid black; padding: 2px;"> <b>AGING FACTOR DELAY:</b>                      10 min.                 </div>	Range: 0 to 30000 min. in steps of 1
	↕	<div style="border: 1px solid black; padding: 2px;"> <b>AGING FACTOR BLOCK:</b>                      Off                 </div>	Range: FlexLogic operand
	↑	<div style="border: 1px solid black; padding: 2px;"> <b>AGING FACTOR TARGET:</b>                      Self-Reset                 </div>	Range: Self-reset, Latched, Disabled

The Aging Factor element detects transformer aging in per-unit normal insulation aging. The element can be set to alarm or trip whenever the computed aging factor is greater than the user-defined pickup setting for the specified time delay.

**AGING FACTOR PICKUP** — Enter a value above which the aging factor element is to operate. Enter a setting greater than the maximum permissible aging factor under emergency loading conditions and maximum ambient temperature.

Figure 5-105: Transformer aging factor logic



### 5.7.3.5 Loss of life

SETTINGS ⇌ GROUPED ELEMENTS ⇌ SETTING GROUP 1(6) ⇌ TRANSFORMER ⇌ LOSS OF LIFE

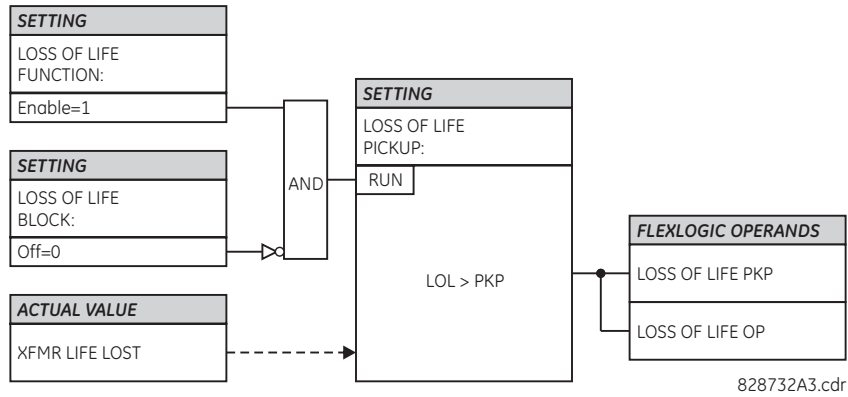
■ LOSS OF LIFE	↔	LOSS OF LIFE FUNCTION: Disabled	Range: Disabled, Enabled
	↕	LOSS OF LIFE INITIAL VALUE: 0 hrs	Range: 0 to 500000 hrs. in steps of 1
	↕	LOSS OF LIFE PICKUP: 180000 hrs	Range: 0 to 500000 hrs. in steps of 1
	↕	LOSS OF LIFE BLOCK: Off	Range: FlexLogic operand
	↑	LOSS OF LIFE TARGET: Self-Reset	Range: Self-reset, Latched, Disabled

The Loss of Life element detects the accumulated total consumed transformer life. This element can be set to issue an alarm or trip when the actual accumulated transformer life becomes larger than the user-specified loss of life pickup value. For new transformers installations, set the **XFMR INITIAL LOSS OF LIFE** setting to “0.” For previously installed transformers, pre-determine the consumed transformer life in hours.

**LOSS OF LIFE INITIAL VALUE** — Enter a setting for the consumed transformer life in hours. When the Loss of Life element is enabled, the computed loss of life is added to the initial loss of life.

**LOSS OF LIFE PICKUP** — Enter the expended life, in hours, required for operation of the element. Set this setting above the total transformer life set as a reference based on nominal loading conditions and a 30°C ambient temperature, as outlined in the IEEE standards.

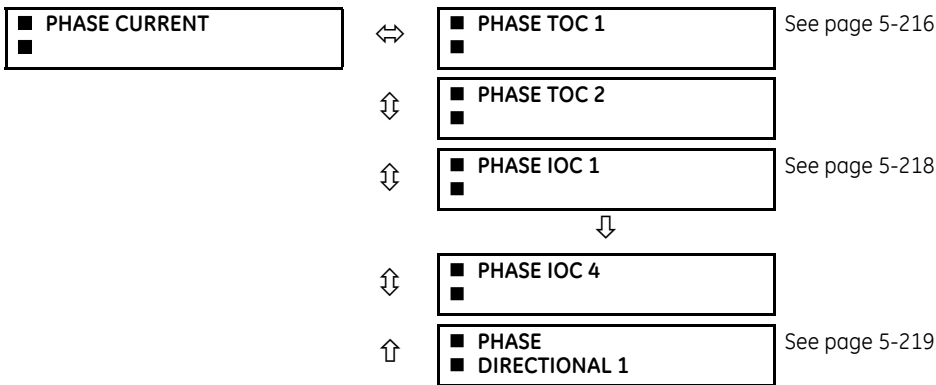
Figure 5-106: Transformer loss of life logic



### 5.7.4 Phase current

#### 5.7.4.1 Menu

SETTINGS ⇨ GROUPED ELEMENTS ⇨ SETTING GROUP 1(6) ⇨ PHASE CURRENT



#### 5.7.4.2 Inverse TOC curve characteristics

The inverse time overcurrent curves used by the time overcurrent elements are the IEEE, IEC, GE Type IAC, and  $I^2t$  standard curve shapes. This allows for simplified coordination with downstream devices.

If none of these curve shapes is adequate, FlexCurves can be used to customize the inverse time curve characteristics. The definite time curve is also an option that can be appropriate if only simple protection is required.

Table 5-26: Overcurrent curve types

IEEE	IEC	GE type IAC	Other
IEEE Extremely Inverse	IEC Curve A (BS142)	IAC Extremely Inverse	$I^2t$
IEEE Very Inverse	IEC Curve B (BS142)	IAC Very Inverse	FlexCurves A, B, C, and D
IEEE Moderately Inverse	IEC Curve C (BS142)	IAC Inverse	Recloser Curves
	IEC Short Inverse	IAC Short Inverse	Definite Time

A time dial multiplier setting allows selection of a multiple of the base curve shape (where the time dial multiplier = 1) with the curve shape (CURVE) setting. Unlike the electromechanical time dial equivalent, operate times are directly proportional to the time multiplier (TD MULTIPLIER) setting value. For example, all times for a multiplier of 10 are 10 times the multiplier 1 or base curve values. Setting the multiplier to zero results in an instantaneous response to all current levels above pickup.

Time overcurrent time calculations are made with an internal *energy capacity* memory variable. When this variable indicates that the energy capacity has reached 100%, a time overcurrent element operates. If less than 100% energy capacity is accumulated in this variable and the current falls below the dropout threshold of 97 to 98% of the pickup value, the variable must be reduced. Two methods of this resetting operation are available: “Instantaneous” and “Timed.” The “Instantaneous” selection is intended for applications with other relays, such as most static relays, which set the energy capacity directly to zero when the current falls below the reset threshold. The “Timed” selection can be used where the relay must coordinate with electromechanical relays.

### IEEE curves

The IEEE time overcurrent curve shapes conform to industry standards and the IEEE C37.112-1996 curve classifications for extremely, very, and moderately inverse curves. The IEEE curves are derived from the operate and reset time equations.

$$T = \text{TDM} \times \left[ \frac{A}{\left(\frac{I}{I_{\text{pickup}}}\right)^p - 1} + B \right], \quad T_{\text{RESET}} = \text{TDM} \times \left[ \frac{t_r}{1 - \left(\frac{I}{I_{\text{pickup}}}\right)^2} \right] \quad \text{Eq. 5-31}$$

where

T = operate time (in seconds)

TDM = Multiplier setting

I = input current

$I_{\text{pickup}}$  = Pickup Current setting

A, B, p = constants defined in the table

$T_{\text{RESET}}$  = reset time in seconds (assuming energy capacity is 100% and RESET is “Timed”)

$t_r$  = characteristic constant defined in the table

**Table 5-27: IEEE inverse time curve constants**

IEEE curve shape	A	B	p	$t_r$
IEEE Extremely Inverse	28.2	0.1217	2.0000	29.1
IEEE Very Inverse	19.61	0.491	2.0000	21.6
IEEE Moderately Inverse	0.0515	0.1140	0.02000	4.85

**Table 5-28: IEEE curve trip times (in seconds)**

Multiplier (TDM)	Current (I / $I_{\text{pickup}}$ )									
	1.5	2.0	3.0	4.0	5.0	6.0	7.0	8.0	9.0	10.0
<b>IEEE Extremely Inverse</b>										
0.5	11.341	4.761	1.823	1.001	0.648	0.464	0.355	0.285	0.237	0.203
1.0	22.682	9.522	3.647	2.002	1.297	0.927	0.709	0.569	0.474	0.407
2.0	45.363	19.043	7.293	4.003	2.593	1.855	1.418	1.139	0.948	0.813
4.0	90.727	38.087	14.587	8.007	5.187	3.710	2.837	2.277	1.897	1.626
6.0	136.090	57.130	21.880	12.010	7.780	5.564	4.255	3.416	2.845	2.439
8.0	181.454	76.174	29.174	16.014	10.374	7.419	5.674	4.555	3.794	3.252
10.0	226.817	95.217	36.467	20.017	12.967	9.274	7.092	5.693	4.742	4.065
<b>IEEE Very Inverse</b>										
0.5	8.090	3.514	1.471	0.899	0.654	0.526	0.450	0.401	0.368	0.345
1.0	16.179	7.028	2.942	1.798	1.308	1.051	0.900	0.802	0.736	0.689
2.0	32.358	14.055	5.885	3.597	2.616	2.103	1.799	1.605	1.472	1.378
4.0	64.716	28.111	11.769	7.193	5.232	4.205	3.598	3.209	2.945	2.756
6.0	97.074	42.166	17.654	10.790	7.849	6.308	5.397	4.814	4.417	4.134
8.0	129.432	56.221	23.538	14.387	10.465	8.410	7.196	6.418	5.889	5.513
10.0	161.790	70.277	29.423	17.983	13.081	10.513	8.995	8.023	7.361	6.891

Multiplier (TDM)	Current (I / I <sub>pickup</sub> )									
	1.5	2.0	3.0	4.0	5.0	6.0	7.0	8.0	9.0	10.0
<b>IEEE Moderately Inverse</b>										
0.5	3.220	1.902	1.216	0.973	0.844	0.763	0.706	0.663	0.630	0.603
1.0	6.439	3.803	2.432	1.946	1.688	1.526	1.412	1.327	1.260	1.207
2.0	12.878	7.606	4.864	3.892	3.377	3.051	2.823	2.653	2.521	2.414
4.0	25.756	15.213	9.729	7.783	6.753	6.102	5.647	5.307	5.041	4.827
6.0	38.634	22.819	14.593	11.675	10.130	9.153	8.470	7.960	7.562	7.241
8.0	51.512	30.426	19.458	15.567	13.507	12.204	11.294	10.614	10.083	9.654
10.0	64.390	38.032	24.322	19.458	16.883	15.255	14.117	13.267	12.604	12.068

**IEC curves**

For European applications, the relay offers three standard curves defined in IEC 255-4 and British standard BS142. These are defined as IEC Curve A, IEC Curve B, and IEC Curve C. The IEC curves are derived by the operate and reset time equations.

$$T = TDM \times \left[ \frac{K}{(I/I_{pickup})^E - 1} \right], \quad T_{RESET} = TDM \times \left[ \frac{t_r}{1 - (I/I_{pickup})^2} \right] \quad \text{Eq. 5-32}$$

where

T = operate time (in seconds)

TDM = Multiplier setting

I = input current

I<sub>pickup</sub> = Pickup Current setting

K, E = constants defined in the table

t<sub>r</sub> = characteristic constant defined in the table

T<sub>RESET</sub> = reset time in seconds (assuming energy capacity is 100% and RESET is "Timed")

**Table 5-29: IEC (BS) inverse time curve constants**

IEC (BS) curve shape	K	E	t <sub>r</sub>
IEC Curve A (BS142)	0.140	0.020	9.7
IEC Curve B (BS142)	13.500	1.000	43.2
IEC Curve C (BS142)	80.000	2.000	58.2
IEC Short Inverse	0.050	0.040	0.500

**Table 5-30: IEC curve trip times (in seconds)**

Multiplier (TDM)	Current (I / I <sub>pickup</sub> )									
	1.5	2.0	3.0	4.0	5.0	6.0	7.0	8.0	9.0	10.0
<b>IEC Curve A</b>										
0.05	0.860	0.501	0.315	0.249	0.214	0.192	0.176	0.165	0.156	0.149
0.10	1.719	1.003	0.630	0.498	0.428	0.384	0.353	0.330	0.312	0.297
0.20	3.439	2.006	1.260	0.996	0.856	0.767	0.706	0.659	0.623	0.594
0.40	6.878	4.012	2.521	1.992	1.712	1.535	1.411	1.319	1.247	1.188
0.60	10.317	6.017	3.781	2.988	2.568	2.302	2.117	1.978	1.870	1.782
0.80	13.755	8.023	5.042	3.984	3.424	3.070	2.822	2.637	2.493	2.376
1.00	17.194	10.029	6.302	4.980	4.280	3.837	3.528	3.297	3.116	2.971
<b>IEC Curve B</b>										
0.05	1.350	0.675	0.338	0.225	0.169	0.135	0.113	0.096	0.084	0.075
0.10	2.700	1.350	0.675	0.450	0.338	0.270	0.225	0.193	0.169	0.150

Multiplier (TDM)	Current (I / I <sub>pickup</sub> )									
	1.5	2.0	3.0	4.0	5.0	6.0	7.0	8.0	9.0	10.0
0.20	5.400	2.700	1.350	0.900	0.675	0.540	0.450	0.386	0.338	0.300
0.40	10.800	5.400	2.700	1.800	1.350	1.080	0.900	0.771	0.675	0.600
0.60	16.200	8.100	4.050	2.700	2.025	1.620	1.350	1.157	1.013	0.900
0.80	21.600	10.800	5.400	3.600	2.700	2.160	1.800	1.543	1.350	1.200
1.00	27.000	13.500	6.750	4.500	3.375	2.700	2.250	1.929	1.688	1.500
<b>IEC Curve C</b>										
0.05	3.200	1.333	0.500	0.267	0.167	0.114	0.083	0.063	0.050	0.040
0.10	6.400	2.667	1.000	0.533	0.333	0.229	0.167	0.127	0.100	0.081
0.20	12.800	5.333	2.000	1.067	0.667	0.457	0.333	0.254	0.200	0.162
0.40	25.600	10.667	4.000	2.133	1.333	0.914	0.667	0.508	0.400	0.323
0.60	38.400	16.000	6.000	3.200	2.000	1.371	1.000	0.762	0.600	0.485
0.80	51.200	21.333	8.000	4.267	2.667	1.829	1.333	1.016	0.800	0.646
1.00	64.000	26.667	10.000	5.333	3.333	2.286	1.667	1.270	1.000	0.808
<b>IEC Short Inverse</b>										
0.05	0.153	0.089	0.056	0.044	0.038	0.034	0.031	0.029	0.027	0.026
0.10	0.306	0.178	0.111	0.088	0.075	0.067	0.062	0.058	0.054	0.052
0.20	0.612	0.356	0.223	0.175	0.150	0.135	0.124	0.115	0.109	0.104
0.40	1.223	0.711	0.445	0.351	0.301	0.269	0.247	0.231	0.218	0.207
0.60	1.835	1.067	0.668	0.526	0.451	0.404	0.371	0.346	0.327	0.311
0.80	2.446	1.423	0.890	0.702	0.602	0.538	0.494	0.461	0.435	0.415
1.00	3.058	1.778	1.113	0.877	0.752	0.673	0.618	0.576	0.544	0.518

### IAC curves

The curves for the General Electric type IAC relay family are derived from the formulae:

$$T = \text{TDM} \times \left( A + \frac{B}{(I/I_{\text{pkp}}) - C} + \frac{D}{((I/I_{\text{pkp}}) - C)^2} + \frac{E}{((I/I_{\text{pkp}}) - C)^3} \right), \quad T_{\text{RESET}} = \text{TDM} \times \left[ \frac{t_r}{1 - (I/I_{\text{pkp}})^2} \right] \quad \text{Eq. 5-33}$$

where

T = operate time (in seconds)

TDM = Multiplier setting

I = Input current

I<sub>pkp</sub> = Pickup Current setting

A to E = constants defined in the table

t<sub>r</sub> = characteristic constant defined in the table

T<sub>RESET</sub> = reset time in seconds (assuming energy capacity is 100% and RESET is "Timed")

**Table 5-31: GE type IAC inverse time curve constants**

IAC curve shape	A	B	C	D	E	t <sub>r</sub>
IAC Extreme Inverse	0.0040	0.6379	0.6200	1.7872	0.2461	6.008
IAC Very Inverse	0.0900	0.7955	0.1000	-1.2885	7.9586	4.678
IAC Inverse	0.2078	0.8630	0.8000	-0.4180	0.1947	0.990
IAC Short Inverse	0.0428	0.0609	0.6200	-0.0010	0.0221	0.222

Table 5-32: GE type IAC curve trip times

Multiplier (TDM)	Current (I / I <sub>pickup</sub> )									
	1.5	2.0	3.0	4.0	5.0	6.0	7.0	8.0	9.0	10.0
<b>IAC Extremely Inverse</b>										
0.5	1.699	0.749	0.303	0.178	0.123	0.093	0.074	0.062	0.053	0.046
1.0	3.398	1.498	0.606	0.356	0.246	0.186	0.149	0.124	0.106	0.093
2.0	6.796	2.997	1.212	0.711	0.491	0.372	0.298	0.248	0.212	0.185
4.0	13.591	5.993	2.423	1.422	0.983	0.744	0.595	0.495	0.424	0.370
6.0	20.387	8.990	3.635	2.133	1.474	1.115	0.893	0.743	0.636	0.556
8.0	27.183	11.987	4.846	2.844	1.966	1.487	1.191	0.991	0.848	0.741
10.0	33.979	14.983	6.058	3.555	2.457	1.859	1.488	1.239	1.060	0.926
<b>IAC Very Inverse</b>										
0.5	1.451	0.656	0.269	0.172	0.133	0.113	0.101	0.093	0.087	0.083
1.0	2.901	1.312	0.537	0.343	0.266	0.227	0.202	0.186	0.174	0.165
2.0	5.802	2.624	1.075	0.687	0.533	0.453	0.405	0.372	0.349	0.331
4.0	11.605	5.248	2.150	1.374	1.065	0.906	0.810	0.745	0.698	0.662
6.0	17.407	7.872	3.225	2.061	1.598	1.359	1.215	1.117	1.046	0.992
8.0	23.209	10.497	4.299	2.747	2.131	1.813	1.620	1.490	1.395	1.323
10.0	29.012	13.121	5.374	3.434	2.663	2.266	2.025	1.862	1.744	1.654
<b>IAC Inverse</b>										
0.5	0.578	0.375	0.266	0.221	0.196	0.180	0.168	0.160	0.154	0.148
1.0	1.155	0.749	0.532	0.443	0.392	0.360	0.337	0.320	0.307	0.297
2.0	2.310	1.499	1.064	0.885	0.784	0.719	0.674	0.640	0.614	0.594
4.0	4.621	2.997	2.128	1.770	1.569	1.439	1.348	1.280	1.229	1.188
6.0	6.931	4.496	3.192	2.656	2.353	2.158	2.022	1.921	1.843	1.781
8.0	9.242	5.995	4.256	3.541	3.138	2.878	2.695	2.561	2.457	2.375
10.0	11.552	7.494	5.320	4.426	3.922	3.597	3.369	3.201	3.072	2.969
<b>IAC Short Inverse</b>										
0.5	0.072	0.047	0.035	0.031	0.028	0.027	0.026	0.026	0.025	0.025
1.0	0.143	0.095	0.070	0.061	0.057	0.054	0.052	0.051	0.050	0.049
2.0	0.286	0.190	0.140	0.123	0.114	0.108	0.105	0.102	0.100	0.099
4.0	0.573	0.379	0.279	0.245	0.228	0.217	0.210	0.204	0.200	0.197
6.0	0.859	0.569	0.419	0.368	0.341	0.325	0.314	0.307	0.301	0.296
8.0	1.145	0.759	0.559	0.490	0.455	0.434	0.419	0.409	0.401	0.394
10.0	1.431	0.948	0.699	0.613	0.569	0.542	0.524	0.511	0.501	0.493

I<sup>2</sup>t curves

The I<sup>2</sup>t curves are derived as follows:

$$T = TDM \times \left[ \frac{100}{\left(\frac{I}{I_{pickup}}\right)^2} \right], \quad T_{RESET} = TDM \times \left[ \frac{100}{\left(\frac{I}{I_{pickup}}\right)^{-2}} \right] \tag{Eq. 5-34}$$

where



T = Operate time (in seconds)

TDM = Multiplier setting

I = Input current

$I_{pickup}$  = Pickup Current setting

$T_{RESET}$  = reset time in seconds (assuming energy capacity is 100% and RESET is "Timed")

**Table 5-33:  $I^2t$  curve trip times**

Multiplier (TDM)	Current (I / $I_{pickup}$ )									
	1.5	2.0	3.0	4.0	5.0	6.0	7.0	8.0	9.0	10.0
0.01	0.44	0.25	0.11	0.06	0.04	0.03	0.02	0.02	0.01	0.01
0.10	4.44	2.50	1.11	0.63	0.40	0.28	0.20	0.16	0.12	0.10
1.00	44.44	25.00	11.11	6.25	4.00	2.78	2.04	1.56	1.23	1.00
10.00	444.44	250.00	111.11	62.50	40.00	27.78	20.41	15.63	12.35	10.00
100.00	4444.4	2500.0	1111.1	625.00	400.00	277.78	204.08	156.25	123.46	100.00
600.00	26666.7	15000.0	6666.7	3750.0	2400.0	1666.7	1224.5	937.50	740.74	600.00

## FlexCurves

FlexCurves are described in the FlexCurves section later in this chapter. The curve shapes for the FlexCurves are derived from the formulae:

$$T = TDM \times \left[ \text{FlexCurve Time at } \left( \frac{I}{I_{pickup}} \right) \right] \text{ when } \left( \frac{I}{I_{pickup}} \right) \geq 1.00 \quad \text{Eq. 5-35}$$

$$T_{RESET} = TDM \times \left[ \text{FlexCurve Time at } \left( \frac{I}{I_{pickup}} \right) \right] \text{ when } \left( \frac{I}{I_{pickup}} \right) \leq 0.98 \quad \text{Eq. 5-36}$$

where

T = operate time (in seconds)

TDM = Multiplier setting

I = Input Current

$I_{pickup}$  = Pickup Current setting

$T_{RESET}$  = Reset Time in seconds (assuming energy capacity is 100% and **RESET**: Timed)

## Definite time curve

The Definite Time curve shape operates as soon as the pickup level is exceeded for a specified period of time. The base definite time curve delay is in seconds. The curve multiplier of 0.00 to 600.00 makes this delay adjustable from instantaneous to 600.00 seconds in steps of 10 ms. The definite time curve shapes are defined as follows:

$$T = TDM \text{ in seconds, when } I > I_{pickup} \quad \text{Eq. 5-37}$$

$$T_{RESET} = TDM \text{ in seconds} \quad \text{Eq. 5-38}$$

where

T = Operate Time (in seconds)

TDM = Multiplier setting

I = Input Current

$I_{pickup}$  = Pickup Current setting

$T_{RESET}$  = Reset Time in seconds (assuming energy capacity is 100% and **RESET**: Timed)

### Recloser curves

The G30 uses the FlexCurve feature to facilitate programming of 41 recloser curves. See the FlexCurves settings section earlier in this chapter for details.

#### 5.7.4.3 Phase time overcurrent (ANSI 51PV, IEC PTOC)

SETTINGS ⇒ GROUPED ELEMENTS ⇒ SETTING GROUP 1(6) ⇒ PHASE CURRENT ⇒ PHASE TOC1(2)

■ PHASE TOC 1	↔	PHASE TOC1 FUNCTION: Disabled	Range: Disabled, Enabled
	↕	PHASE TOC1 SIGNAL SOURCE: SRC 1	Range: SRC 1, SRC 2, SRC 3, SRC 4
	↕	PHASE TOC1 INPUT: Phasor	Range: Phasor, RMS
	↕	PHASE TOC1 PICKUP: 1.000 pu	Range: 0.020 to 30.000 pu in steps of 0.001
	↕	PHASE TOC1 CURVE: IEEE Mod Inv	Range: see Overcurrent Curve Types table
	↕	PHASE TOC1 TD MULTIPLIER: 1.00	Range: 0.00 to 600.00 in steps of 0.01
	↕	PHASE TOC1 RESET: Instantaneous	Range: Instantaneous, Timed
	↕	PHASE TOC1 VOLTAGE RESTRAINT: Disabled	Range: Disabled, Enabled
	↕	PHASE TOC1 BLOCK A: Off	Range: FlexLogic operand
	↕	PHASE TOC1 BLOCK B: Off	Range: FlexLogic operand
	↕	PHASE TOC1 BLOCK C: Off	Range: FlexLogic operand
	↕	PHASE TOC1 TARGET: Self-reset	Range: Self-reset, Latched, Disabled
	↑	PHASE TOC1 EVENTS: Disabled	Range: Disabled, Enabled

The phase time overcurrent element can provide a specified time-delay operating characteristic versus the applied current or be used as a simple definite time element. The phase current input quantities can be programmed as fundamental phasor magnitude or total waveform RMS magnitude as required by the application.

Two methods of resetting operation are available: “Timed” and “Instantaneous” (see the Inverse TOC Curve Characteristics section earlier for details on curve setup, trip times, and reset operation). When the element is blocked, the time accumulator resets according to the reset characteristic. For example, if the element reset characteristic is set to “Instantaneous” and the element is blocked, the time accumulator clears immediately.

The **PHASE TOC1 PICKUP** setting can be reduced dynamically by a voltage restraint feature (when enabled). This is accomplished via the multipliers (Mvr) corresponding to the phase-phase voltages of the voltage restraint characteristic curve (see the figure); the pickup level is calculated as Mvr times the **PHASE TOC1 PICKUP** setting. If the voltage restraint feature is disabled, the pickup level always remains at the setting value.

Figure 5-107: Phase time overcurrent voltage restraint characteristic



**FUNCTION** — This setting enables and disables the phase time overcurrent protection element.

**SIGNAL SOURCE** — Selects the signal source for the phase time overcurrent protection element.

**INPUT** — Selects how phase current input quantities are interpreted by the G30. Inputs can be selected as fundamental phasor magnitudes or total waveform RMS magnitudes as required by the application.

**PICKUP** — Specifies the phase time overcurrent pickup level in per-unit values.

**CURVE** — Selects the time inverse overcurrent curve style.

**TD MULTIPLIER** — Specifies a multiple of the base curve shape specified by the **CURVE** setting. Programming this value to zero results in an instantaneous response to all current levels above pickup.

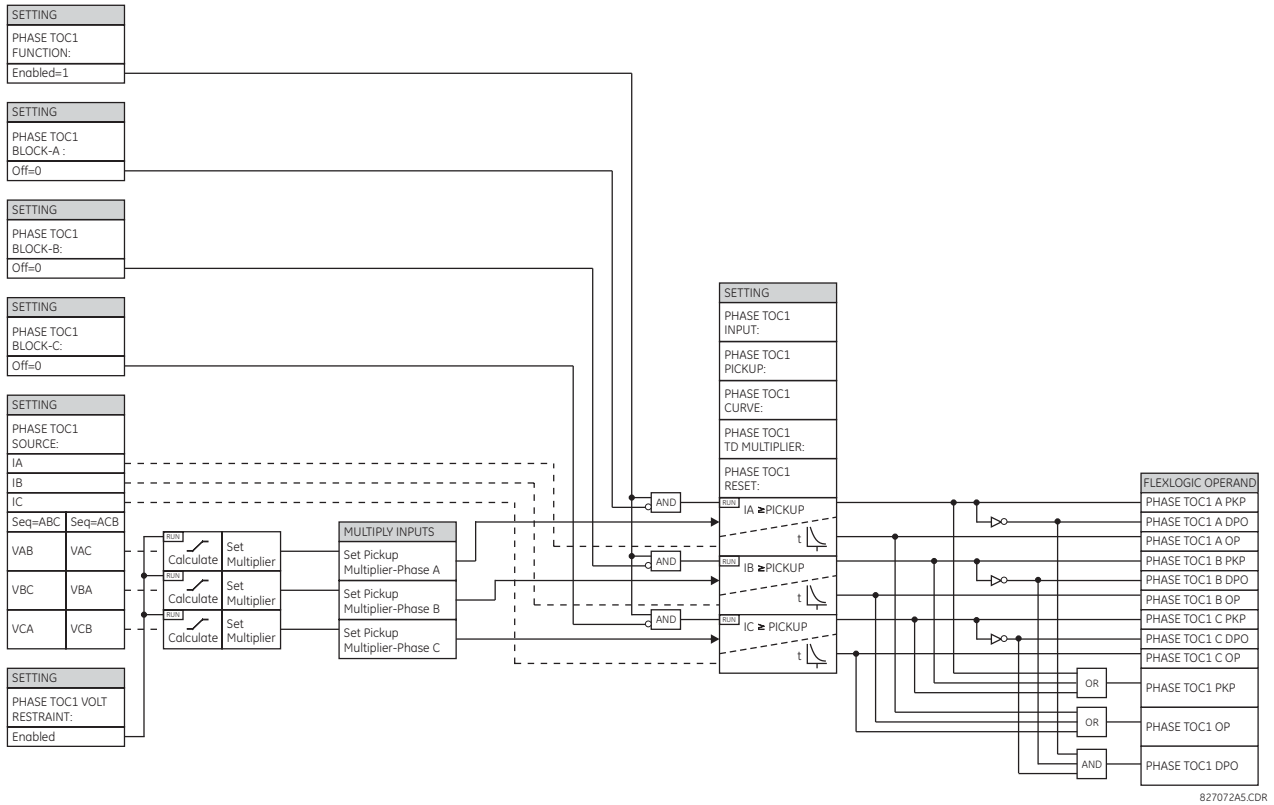
**RESET** — The “Instantaneous” reset method is intended for applications with other relays, such as most static relays, which set the energy capacity directly to zero when the current falls below the reset threshold. The “Timed” reset method can be used where the relay must coordinate with electromechanical relays.

**VOLTAGE RESTRAINT** — Enables and disables the phase time overcurrent voltage restraint feature.

**BLOCK A** — Assertion of the operand assigned to this setting blocks phase A of the phase time overcurrent element.

**EVENTS** — Enables and disables the logging of phase time overcurrent events in the sequence of events recorder.

Figure 5-108: Phase time overcurrent 1 logic



B27072A5.CDR

5

5.7.4.4 Phase instantaneous overcurrent (ANSI 50P, IEC PI0C)

SETTINGS ⇄ GROUPED ELEMENTS ⇒ SETTING GROUP 1(6) ⇒ PHASE CURRENT ⇒ PHASE IOC 1(4)

■ PHASE IOC 1	⇄	PHASE IOC1 FUNCTION: Disabled	Range: Disabled, Enabled
■	⇄	PHASE IOC1 SOURCE: SRC 1	Range: SRC 1, SRC 2, SRC 3, SRC 4
	⇄	PHASE IOC1 PICKUP: 1.000 pu	Range: 0.005 to 30.000 pu in steps of 0.001
	⇄	PHASE IOC1 PICKUP DELAY: 0.00 s	Range: 0.00 to 600.00 s in steps of 0.01
	⇄	PHASE IOC1 RESET DELAY: 0.00 s	Range: 0.00 to 600.00 s in steps of 0.01
	⇄	PHASE IOC1 BLOCK A: Off	Range: FlexLogic operand
	⇄	PHASE IOC1 BLOCK C: Off	Range: FlexLogic operand
	⇄	PHASE IOC1 TARGET: Self-reset	Range: Self-reset, Latched, Disabled
	⇄	PHASE IOC1 EVENTS: Disabled	Range: Disabled, Enabled

The phase instantaneous overcurrent element can be used as an instantaneous element with no intentional delay or as a definite time element. The input current is the fundamental phasor magnitude. For timing curves, see the publication Instantaneous Overcurrent (IOC) Element Response to Saturated Waveforms in UR Series Relays ([GET-8400A](#)).

**FUNCTION** — This setting enables and disables the phase instantaneous overcurrent protection element.

**SOURCE** — Selects the signal source for the phase instantaneous overcurrent protection element.

**PICKUP** — Specifies the phase instantaneous overcurrent pickup level in per-unit values.

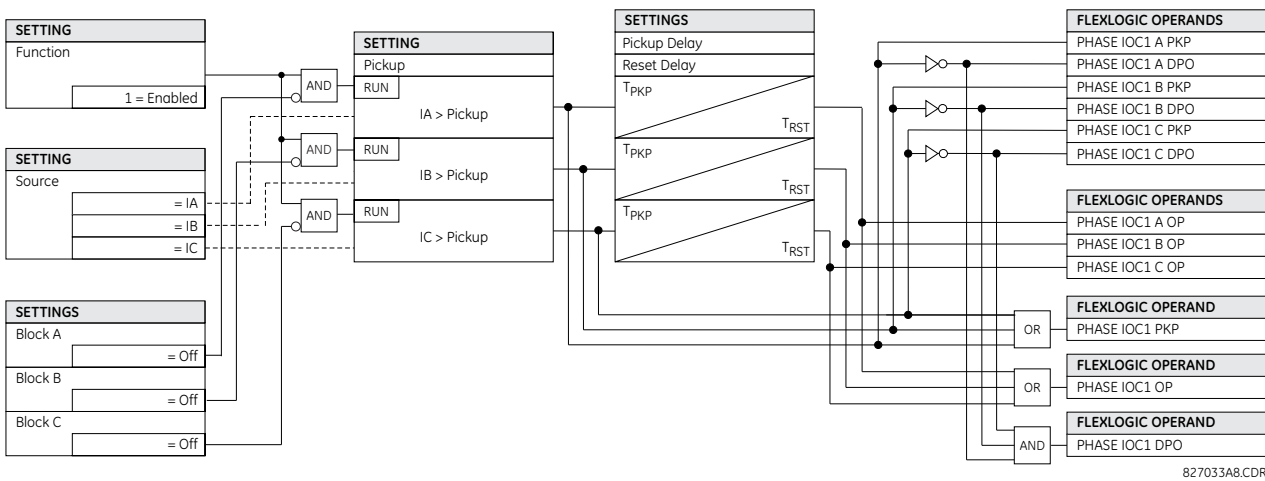
**DELAY** — Delays the assertion of the **PHASE IOC OP** operands. It is used to achieve timing coordination with other elements and relays.

**RESET DELAY** — Specifies a delay for the reset of the phase instantaneous overcurrent element between the operate output state and the return to logic 0 after the input passes outside the defined pickup range. This setting is used to ensure that the relay output contacts are closed long enough to ensure reception by downstream equipment.

**BLOCK A** — Assertion of the operand assigned to this setting block’s phase A of the phase instantaneous overcurrent element.

**EVENTS** — Enables and disables the logging of phase instantaneous overcurrent events in the sequence of events recorder.

Figure 5-109: Phase instantaneous overcurrent 1 logic



5.7.4.5 Phase directional overcurrent (ANSI 67P, IEC PDOC/PTOC)

SETTINGS ⇨ GROUPED ELEMENTS ⇨ SETTING GROUP 1(6) ⇨ PHASE CURRENT ⇨ PHASE DIRECTIONAL 1

<ul style="list-style-type: none"> <li>■ PHASE</li> <li>■ DIRECTIONAL 1</li> </ul>	⇔	<b>PHASE DIR 1</b> FUNCTION: Disabled Range: Disabled, Enabled
	⇕	<b>PHASE DIR 1 SIGNAL</b> SOURCE: SRC 1 Range: SRC 1, SRC 2, SRC 3, SRC 4
	⇕	<b>PHASE DIR 1 BLOCK:</b> Off Range: FlexLogic operand
	⇕	<b>PHASE DIR 1</b> ECA: 30° Range: 0 to 359° in steps of 1
	⇕	<b>PHASE DIR POL V1</b> THRESHOLD: 0.700 pu Range: 0.004 to 3.000 pu in steps of 0.001
	⇕	<b>PHASE DIR 1 BLOCK</b> WHEN V MEM EXP: No Range: No, Yes
	⇕	<b>PHASE DIR 1</b> TARGET: Self-reset Range: Self-reset, Latched, Disabled

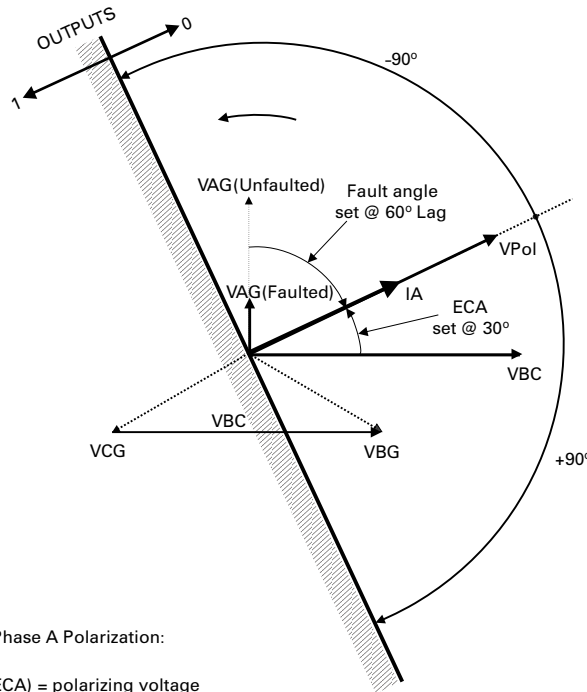
↑ PHASE DIR 1  
EVENTS: Disabled Range: Disabled, Enabled



The TARGET setting is not user-selectable and forced to "Disabled". If Targets are required from directional elements, it can be achieved by assigning directional element output to a digital element, where targets selection can be used as required.

The phase directional elements (one for each of phases A, B, and C) determine the phase current flow direction for steady state and fault conditions and can be used to control the operation of the phase overcurrent elements via the **BLOCK** inputs of these elements.

Figure 5-110: Phase A directional polarization



Phasors for Phase A Polarization:

$VPOL = VBC * (1/_ECA) = \text{polarizing voltage}$

IA = operating current

ECA = Element Characteristic Angle @ 30

827800A2.CDR

This element is intended to apply a block signal to an overcurrent element to prevent an operation when current is flowing in a particular direction. The direction of current flow is determined by measuring the phase angle between the current from the phase CTs and the line-line voltage from the VTs, based on the 90° or quadrature connection. If there is a requirement to supervise overcurrent elements for flows in opposite directions, such as can happen through a bus-tie breaker, two phase directional elements should be programmed with opposite element characteristic angle (ECA) settings.

To increase security for three phase faults very close to the VTs used to measure the polarizing voltage, a voltage memory feature is incorporated. This feature stores the polarizing voltage the moment before the voltage collapses, and uses it to determine direction. The voltage memory remains valid for one second after the voltage has collapsed.

The main component of the phase directional element is the phase angle comparator with two inputs: the operating signal (phase current) and the polarizing signal (the line voltage, shifted in the leading direction by the characteristic angle, ECA).

The table shows the operating and polarizing signals used for phase directional control.

Table 5-34: Operating and polarizing signals

Phase	Operating signal	Polarizing signal $V_{pol}$	
		ABC phase sequence	ACB phase sequence
A	angle of IA	angle of VBC $\times (1 \angle ECA)$	angle of VCB $\times (1 \angle ECA)$
B	angle of IB	angle of VCA $\times (1 \angle ECA)$	angle of VAC $\times (1 \angle ECA)$
C	angle of IC	angle of VAB $\times (1 \angle ECA)$	angle of VBA $\times (1 \angle ECA)$

### Mode of operation

- When the function is “Disabled” or the operating current is below  $5\% \times CT$  nominal, the element output is logic “0”
- When the function is “Enabled,” the operating current is above  $5\% \times CT$  nominal, and the polarizing voltage is above the **PRODUCT SETUP**  $\Rightarrow$  **DISPLAY PROPERTIES**  $\Rightarrow$  **VOLTAGE CUT-OFF LEVEL** value, the element output is dependent on the phase angle between the operating and polarizing signals:
  - The element output is logic “0” when the operating current is within polarizing voltage  $\pm 90^\circ$
  - For all other angles, the element output is logic “1”
- Once the voltage memory has expired, the phase overcurrent elements under directional control can be set to block or trip on overcurrent as follows:
  - When **BLOCK WHEN V MEM EXP** is set to “Yes,” the directional element blocks the operation of any phase overcurrent element under directional control when voltage memory expires
  - When **BLOCK WHEN V MEM EXP** is set to “No,” the directional element allows tripping of phase overcurrent elements under directional control when voltage memory expires

In all cases, directional blocking is permitted to resume when the polarizing voltage becomes greater than the polarizing voltage threshold.

### Settings

**PHASE DIR 1 FUNCTION** — This setting enables and disables the phase directional overcurrent protection element.

**PHASE DIR 1 SIGNAL SOURCE** — This setting is used to select the source for the operating and polarizing signals. The operating current for the phase directional element is the phase current for the selected current source. The polarizing voltage is the line voltage from the phase VTs, based on the  $90^\circ$  or quadrature connection and shifted in the leading direction by the element characteristic angle (ECA).

**PHASE DIR 1 BLOCK** — Assertion of the operand assigned to this setting blocks operation of the phase directional overcurrent element.

**PHASE DIR 1 ECA** — This setting specifies the element characteristic angle, that is, the angle by which the polarizing voltage is shifted in the leading direction to achieve dependable operation. In the design of the UR-series elements, a block is applied to an element by asserting logic 1 at the blocking input. Program the phase directional overcurrent element using this setting so that the output is logic 1 for current in the non-tripping direction.

**PHASE DIR 1 POL V THRESHOLD** — This setting is used to establish the minimum level of voltage for which the phase angle measurement is reliable. The setting is based on VT accuracy.

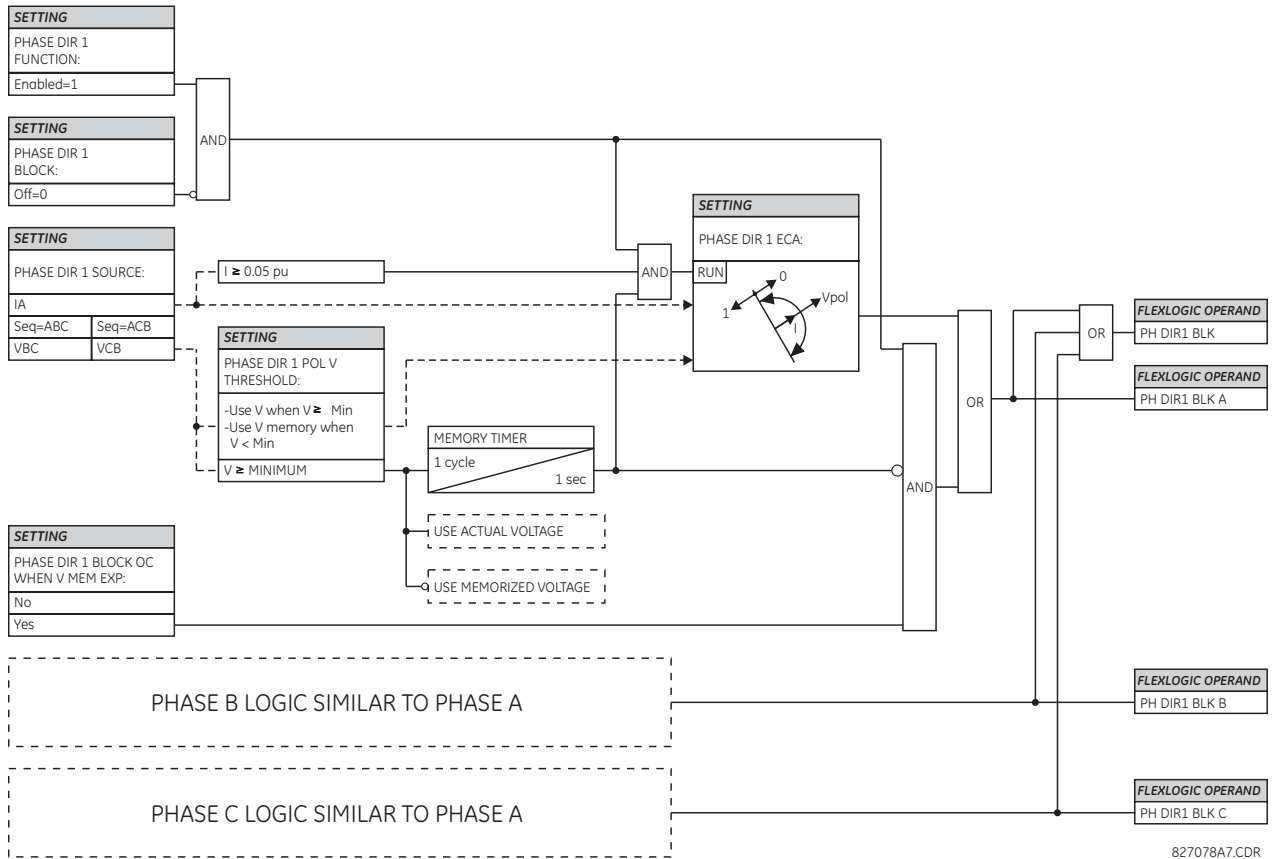
**PHASE DIR 1 BLOCK WHEN V MEM EXP** — This setting is used to select the required operation upon expiration of voltage memory. When set to “Yes,” the directional element blocks the operation of any phase overcurrent element under directional control, when voltage memory expires. When set to “No,” the directional element allows tripping of phase overcurrent elements under directional control.

**PHASE DIR 1 EVENTS** — This setting enables and disables the logging of phase directional overcurrent events in the sequence of events recorder.



The phase directional element responds to the forward load current. In the case of a following reverse fault, the element needs some time—in the order of 8 ms—to establish a blocking signal. Some protection elements, such as instantaneous overcurrent, respond to reverse faults before the blocking signal is established. Therefore, a coordination time of at least 10 ms must be added to all the instantaneous protection elements under the supervision of the phase directional element. If current reversal is of concern, a longer delay—in the order of 20 ms—is needed.

Figure 5-111: Phase directional logic

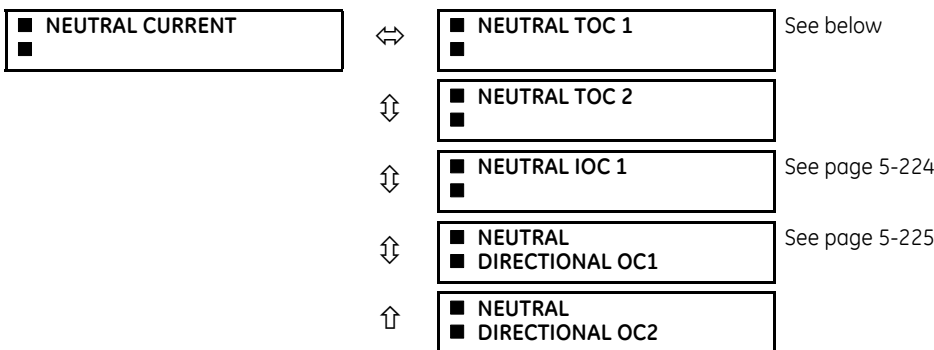


5

## 5.7.5 Neutral current

### 5.7.5.1 Menu

SETTINGS ⇨ GROUPED ELEMENTS ⇨ SETTING GROUP 1(6) ⇨ NEUTRAL CURRENT





### 5.7.5.2 Neutral time overcurrent (ANSI 51N, IEC PTOC)

SETTINGS ⇒ GROUPED ELEMENTS ⇒ SETTING GROUP 1(6) ⇒ NEUTRAL CURRENT ⇒ NEUTRAL TOC1(2)

■ NEUTRAL TOC1	↔	NEUTRAL TOC1 FUNCTION: Disabled	Range: Disabled, Enabled
	↕	NEUTRAL TOC1 SIGNAL SOURCE: SRC 1	Range: SRC 1, SRC 2, SRC 3, SRC 4
	↕	NEUTRAL TOC1 INPUT: Phasor	Range: Phasor, RMS
	↕	NEUTRAL TOC1 PICKUP: 1.000 pu	Range: 0.020 to 30.000 pu in steps of 0.001
	↕	NEUTRAL TOC1 CURVE: IEEE Mod Inv	Range: see Overcurrent Curve Types table
	↕	NEUTRAL TOC1 TD MULTIPLIER: 1.00	Range: 0.00 to 600.00 in steps of 0.01
	↕	NEUTRAL TOC1 RESET: Instantaneous	Range: Instantaneous, Timed
	↕	NEUTRAL TOC1 BLOCK: Off	Range: FlexLogic operand
	↕	NEUTRAL TOC1 TARGET: Self-reset	Range: Self-reset, Latched, Disabled
	↑	NEUTRAL TOC1 EVENTS: Disabled	Range: Disabled, Enabled

The neutral time overcurrent element can provide a desired time-delay operating characteristic versus the applied current or be used as a simple definite time element. The neutral current input value is a quantity calculated as  $3I_0$  from the phase currents and can be programmed as fundamental phasor magnitude or total waveform RMS magnitude as required by the application.

Two methods of resetting operation are available: “Timed” and “Instantaneous” (see the Inverse TOC Curve Characteristics section for details on curve setup, trip times, and reset operation). When the element is blocked, the time accumulator resets according to the reset characteristic. For example, if the element reset characteristic is set to “Instantaneous” and the element is blocked, the time accumulator clears immediately.

**NEUTRAL TOC1 FUNCTION** — This setting enables and disables the neutral time overcurrent protection element.

**NEUTRAL TOC1 SIGNAL SOURCE** — This setting selects the signal source for the neutral time overcurrent protection element.

**NEUTRAL TOC1 INPUT** — This setting selects how neutral current input quantities are interpreted by the G30. Inputs can be selected as fundamental phasor magnitudes or total waveform RMS magnitudes as required by the application.

**NEUTRAL TOC1 PICKUP** — This setting specifies the neutral time overcurrent pickup level in per-unit values.

**NEUTRAL TOC1 CURVE** — This setting selects the inverse time overcurrent curve style.

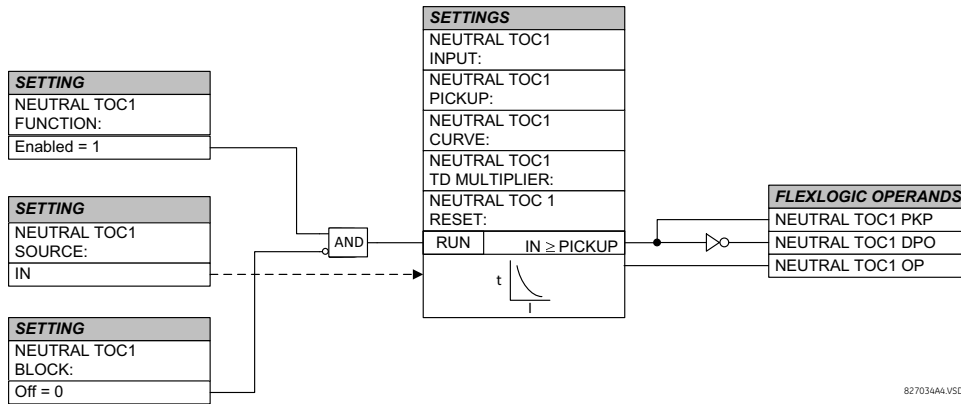
**NEUTRAL TOC1 TD MULTIPLIER** — This setting specifies a multiple of the base curve shape specified by the **CURVE** setting. Programming this value to zero results in an instantaneous response to all current levels above pickup.

**NEUTRAL TOC1 RESET** — The “Instantaneous” reset method is intended for applications with other relays, such as most static relays, which set the energy capacity directly to zero when the current falls below the reset threshold. The “Timed” reset method can be used where the relay must coordinate with electromechanical relays.

**NEUTRAL TOC1 BLOCK** — Assertion of the operand assigned to this setting blocks operation of the neutral time overcurrent element.

**NEUTRAL TOC1 EVENTS** — This setting enables and disables the logging of neutral time overcurrent events in the sequence of events recorder.

Figure 5-112: Neutral time overcurrent 1 logic



5.7.5.3 Neutral instantaneous overcurrent (ANSI 50N, IEC PIOC)

SETTINGS ⇒ GROUPED ELEMENTS ⇒ SETTING GROUP 1(6) ⇒ NEUTRAL CURRENT ⇒ NEUTRAL IOC1

■ NEUTRAL IOC1	↔	NEUTRAL IOC1 FUNCTION: Disabled	Range: Disabled, Enabled
	↕	NEUTRAL IOC1 SIGNAL SOURCE: SRC 1	Range: SRC 1, SRC 2, SRC 3, SRC 4
	↕	NEUTRAL IOC1 PICKUP: 1.000 pu	Range: 0.020 to 30.000 pu in steps of 0.001
	↕	NEUTRAL IOC1 PICKUP DELAY: 0.00 s	Range: 0.00 to 600.00 s in steps of 0.01
	↕	NEUTRAL IOC1 RESET DELAY: 0.00 s	Range: 0.00 to 600.00 s in steps of 0.01
	↕	NEUTRAL IOC1 BLOCK: Off	Range: FlexLogic operand
	↕	NEUTRAL IOC1 TARGET: Self-reset	Range: Self-reset, Latched, Disabled
	↕	NEUTRAL IOC1 EVENTS: Disabled	Range: Disabled, Enabled

The neutral instantaneous overcurrent element can be used as an instantaneous function with no intentional delay or as a definite time function. The element essentially responds to the magnitude of a neutral current fundamental frequency phasor calculated from the phase currents. A positive-sequence restraint is applied for better performance. A small portion (6.25%) of the positive-sequence current magnitude is subtracted from the zero-sequence current magnitude when forming the operating quantity of the element as follows:

$$I_{op} = 3 \times (|I_0| - K \times |I_1|) \text{ where } K = 1/16 \tag{Eq. 5-39}$$

The positive-sequence restraint allows for more sensitive settings by counterbalancing spurious zero-sequence currents resulting from:

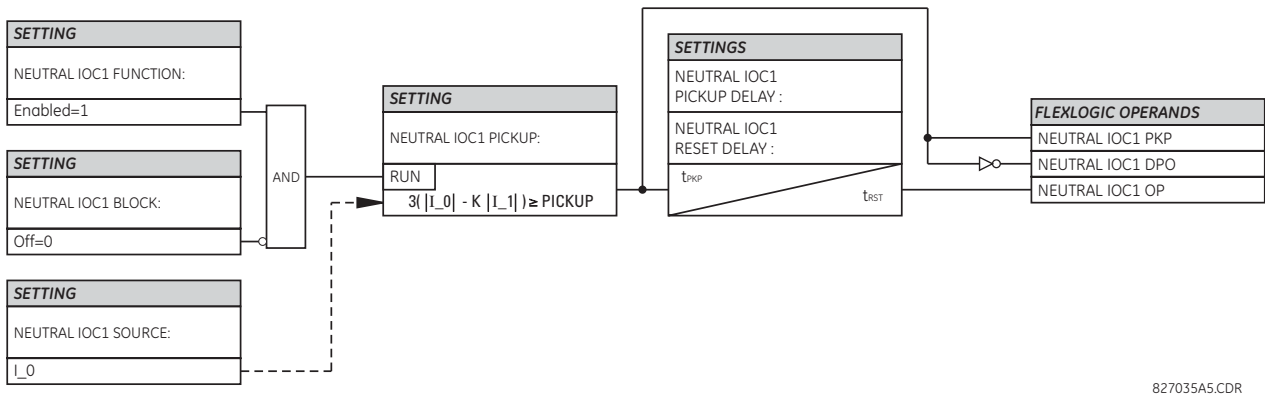
- System unbalances under heavy load conditions
- Transformation errors of current transformers (CTs) during double-line and three-phase faults
- Switch-off transients during double-line and three-phase faults

The positive-sequence restraint must be considered when testing for pickup accuracy and response time (multiple of pickup). The operating quantity depends on how test currents are injected into the relay (single-phase injection):

$$I_{op} = \frac{1}{3} \times (3 - K) \times I_{injected} \tag{Eq. 5-40}$$

- NEUTRAL IOC1 FUNCTION** — This setting enables and disables the neutral instantaneous overcurrent protection element.
- NEUTRAL IOC1 SIGNAL SOURCE** — This setting selects the signal source for the neutral instantaneous overcurrent protection element.
- NEUTRAL IOC1 PICKUP** — This setting specifies the neutral instantaneous overcurrent pickup level in per-unit values.
- NEUTRAL IOC1 PICKUP DELAY** — This setting delays the assertion of the **NEUTRAL IOC OP** operands. It is used to achieve timing coordination with other elements and relays.
- NEUTRAL IOC1 RESET DELAY** — This setting specifies a delay for the reset of the neutral instantaneous overcurrent element between the operate output state and the return to logic 0 after the input passes outside the defined pickup range. This setting is used to ensure that the relay output contacts are closed long enough to ensure reception by downstream equipment.
- NEUTRAL IOC1 BLOCK** — Assertion of the operand assigned to this setting blocks operation of the neutral instantaneous overcurrent element.
- NEUTRAL IOC1 EVENTS** — This setting enables and disables the logging of neutral instantaneous overcurrent events in the sequence of events recorder.

Figure 5-113: Neutral IOC1 logic



827035A5.CDR



### 5.7.5.4 Neutral directional overcurrent (ANSI 67N, IEC PDEF/PTOC)

SETTINGS ⇄ GROUPED ELEMENTS ⇄ SETTING GROUP 1(6) ⇄ NEUTRAL CURRENT ⇄ NEUTRAL DIRECTIONAL OC1(2)

<ul style="list-style-type: none"> <li>■ NEUTRAL</li> <li>■ DIRECTIONAL OC1</li> </ul>	⇄	NEUTRAL DIR OC1 FUNCTION: Disabled	Range: Disabled, Enabled
	⇄	NEUTRAL DIR OC1 SOURCE: SRC 1	Range: SRC 1, SRC 2, SRC 3, SRC 4
	⇄	NEUTRAL DIR OC1 POLARIZING: Voltage	Range: Voltage, Current, Dual, Dual-V, Dual-I
	⇄	NEUTRAL DIR OC1 POL VOLT: Calculated V0	Range: Calculated V0, Measured VX
	⇄	NEUTRAL DIR OC1 OP CURR: Calculated 3I0	Range: Calculated 3I0, Measured IG
	⇄	NEUTRAL DIR OC1 POS-SEQ RESTRAINT: 0.063	Range: 0.000 to 0.500 in steps of 0.001

⇅	NEUTRAL DIR OC1 OFFSET: 0.00 Ω	Range: 0.00 to 250.00 Ω in steps of 0.01
⇅	NEUTRAL DIR OC1 FWD ECA: 75° Lag	Range: -90 to 90° in steps of 1
⇅	NEUTRAL DIR OC1 FWD LIMIT ANGLE: 90°	Range: 40 to 90° in steps of 1
⇅	NEUTRAL DIR OC1 FWD PICKUP: 0.050 pu	Range: 0.006 to 30.000 pu in steps of 0.001
⇅	NEUTRAL DIR OC1 REV LIMIT ANGLE: 90°	Range: 40 to 90° in steps of 1
⇅	NEUTRAL DIR OC1 REV PICKUP: 0.050 pu	Range: 0.006 to 30.000 pu in steps of 0.001
⇅	NEUTRAL DIR OC1 BLK: Off	Range: FlexLogic operand
⇅	NEUTRAL DIR OC1 TARGET: Self-reset	Range: Self-reset, Latched, Disabled
⇅	NEUTRAL DIR OC1 EVENTS: Disabled	Range: Disabled, Enabled

The neutral directional overcurrent element provides both forward and reverse fault direction indications for the **NEUTRAL DIR OC1 FWD** and **NEUTRAL DIR OC1 REV** operands, respectively. The output operand is asserted if the magnitude of the operating current is above a pickup level (overcurrent unit) and the fault direction is seen as forward or reverse, respectively (directional unit).

The **overcurrent unit** responds to the magnitude of a fundamental frequency phasor of either the neutral current calculated from the phase currents or the ground current. There are separate pickup settings for the forward-looking and reverse-looking functions. If set to use the calculated  $3I_0$ , the element applies a positive-sequence restraint for better performance: a small user-programmable portion of the positive-sequence current magnitude is subtracted from the zero-sequence current magnitude when forming the operating quantity.

$$I_{op} = 3 \times (|I_0| - K \times |I_1|) \tag{Eq. 5-41}$$

The positive-sequence restraint allows for more sensitive settings by counterbalancing spurious zero-sequence currents resulting from

- System unbalances under heavy load conditions
- Transformation errors of current transformers (CTs) during double-line and three-phase faults
- Switch-off transients during double-line and three-phase faults

The positive-sequence restraint must be considered when testing for pickup accuracy and response time (multiple of pickup). The operating quantity depends on the way the test currents are injected into the relay (single-phase injection:  $I_{op} = (1 - K) \times I_{injected}$ ; three-phase pure zero-sequence injection:  $I_{op} = 3 \times I_{injected}$ ).

The positive-sequence restraint is removed for low currents. If the positive-sequence current is below 0.8 pu, the restraint is removed by changing the constant K to zero. This facilitates better response to high-resistance faults when the unbalance is very small and there is no danger of excessive CT errors as the current is low.

The **directional unit** uses the zero-sequence current ( $I_0$ ) or ground current (IG) for fault direction discrimination and can be programmed to use either zero-sequence voltage ("Calculated V0" or "Measured VX"), ground current (IG), or both for polarizing. The zero-sequence current ( $I_0$ ) must be greater than the **PRODUCT SETUP** ⇒ **DISPLAY PROPERTIES** ⇒ **CURRENT CUT-OFF LEVEL** setting value and IG must be greater than 0.05 pu to be validated as the operating quantity for directional current. The following tables define the neutral directional overcurrent element.  $V_0$  is the zero-sequence voltage,  $I_0$  is the zero-sequence current, ECA is the element characteristic angle, and IG is the ground current.

Table 5-35: Quantities for "calculated 3I0" configuration

Directional unit				Overcurrent unit
Polarizing mode	Direction	Compared phasors		
Voltage	Forward	$-V_0 + Z_{\text{offset}} \times I_0$	$I_0 \times 1 \angle \text{ECA}$	$I_{\text{op}} = 3 \times ( I_0  - K \times  I_1 )$ if $ I_1  > 0.8 \text{ pu}$ $I_{\text{op}} = 3 \times ( I_0 )$ if $ I_1  \leq 0.8 \text{ pu}$
	Reverse	$-V_0 + Z_{\text{offset}} \times I_0$	$-I_0 \times 1 \angle \text{ECA}$	
Current	Forward	IG	$I_0$	
	Reverse	IG	$-I_0$	
Dual, Dual-V, Dual-I	Forward	$-V_0 + Z_{\text{offset}} \times I_0$	$I_0 \times 1 \angle \text{ECA}$	
		or		
		IG	$I_0$	
	Reverse	$-V_0 + Z_{\text{offset}} \times I_0$	$-I_0 \times 1 \angle \text{ECA}$	
		or		
		IG	$-I_0$	

Table 5-36: Quantities for "measured IG" configuration

Directional unit				Overcurrent unit
Polarizing mode	Direction	Compared phasors		
Voltage	Forward	$-V_0 + Z_{\text{offset}} \times IG/3$	$IG \times 1 \angle \text{ECA}$	$I_{\text{op}} =  IG $
	Reverse	$-V_0 + Z_{\text{offset}} \times IG/3$	$-IG \times 1 \angle \text{ECA}$	

where

$$V_0 = \frac{1}{3}(V_{AG} + V_{BG} + V_{CG}) = \text{zero sequence voltage}$$

$$I_0 = \frac{1}{3}I_N = \frac{1}{3}(I_A + I_B + I_C) = \text{zero sequence current}$$

ECA = element characteristic angle

IG = ground current

Z\_offset is the offset impedance, for which magnitude is the OFFSET setting and angle is the FWD ECA

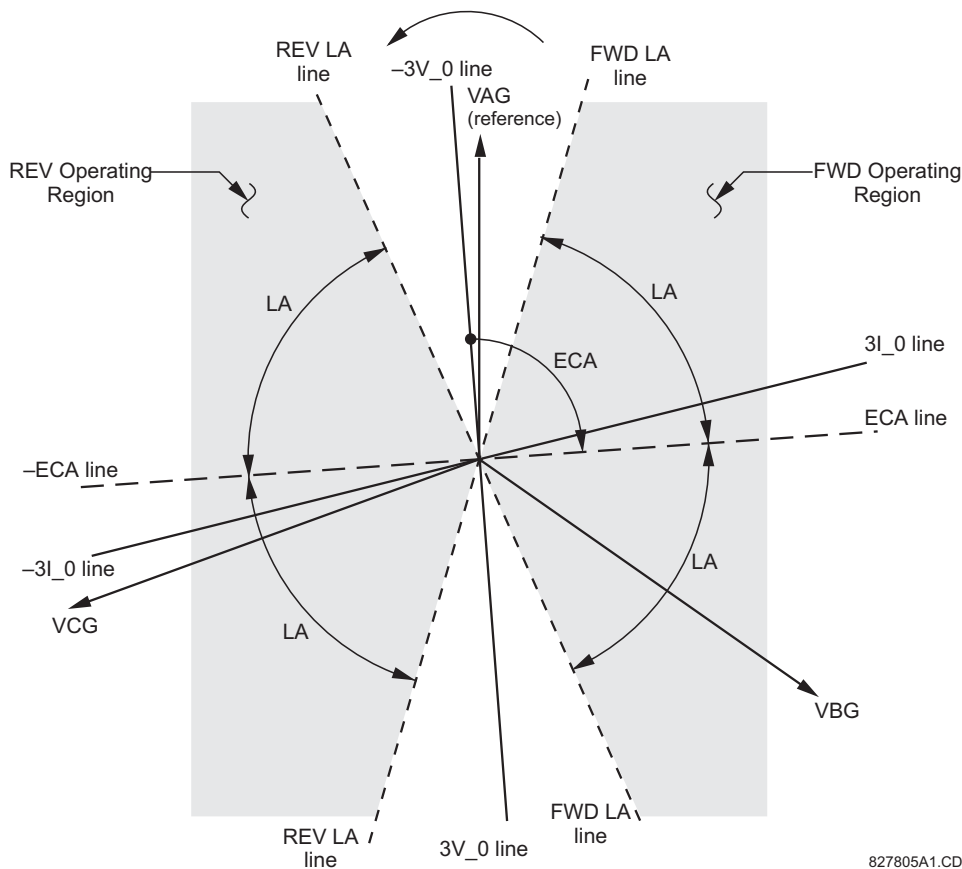
When **NEUTRAL DIR OC1 POL VOLT** is set to "Measured VX," one-third of this voltage is used in place of V\_0. The following figure explains the usage of the voltage polarized directional unit of the element.

The figure shows the voltage-polarized phase angle comparator characteristics for a phase A to ground fault, with:

- ECA = 90° (element characteristic angle = centerline of operating characteristic)
- FWD LA = 80° (forward limit angle = the ± angular limit with the ECA for operation)
- REV LA = 80° (reverse limit angle = the ± angular limit with the ECA for operation)

Take the bias into account when using the neutral directional overcurrent element to directionalize other protection elements.

Figure 5-114: Neutral directional voltage-polarized characteristics



**NEUTRAL DIR OC1 POLARIZING** – This setting selects the polarizing mode for the directional unit.

- If “Voltage” polarizing is selected, the element uses the zero-sequence voltage angle for polarization. The user can use either the zero-sequence voltage  $V_0$  calculated from the phase voltages, or the zero-sequence voltage supplied externally as the auxiliary voltage  $V_X$ , both from the **NEUTRAL DIR OC1 SOURCE**.

The calculated  $V_0$  can be used as polarizing voltage only if the voltage transformers are connected in Wye. The auxiliary voltage can be used as the polarizing voltage provided **SYSTEM SETUP ⇒ AC INPUTS ⇒ VOLTAGE BANK ⇒ AUXILIARY VT CONNECTION** is set to “Vn” and the auxiliary voltage is connected to a zero-sequence voltage source (such as broken delta connected secondary of VTs).

The zero-sequence voltage  $V_0$  must be greater than 0.02 pu to be validated for use as a polarizing signal. Additionally, when offset impedance is applied and zero-sequence current is above 0.2 pu, compensated zero-sequence voltage  $-V_0 + Z_{offset} \times I_0$  has to be above 0.02 pu in order to discriminate fault direction; otherwise when zero-sequence current is less than 0.2 pu,  $-V_0$  is then used as the polarizing signal. If the polarizing signal is invalid, neither forward nor reverse indication is given.

- If “Current” polarizing is selected, the element uses the ground current angle connected externally and configured under **NEUTRAL OC1 SOURCE** for polarization. The ground CT must be connected between the ground and neutral point of an adequate local source of ground current. The ground current must be greater than 0.05 pu to be validated as a polarizing signal. If the polarizing signal is not valid, neither forward nor reverse indication is given. In addition, the zero-sequence current ( $I_0$ ) must be greater than the **PRODUCT SETUP ⇒ DISPLAY PROPERTIES ⇒ CURRENT CUT-OFF LEVEL** setting value.

For a choice of current polarizing, it is recommended that the polarizing signal be analyzed to ensure that a known direction is maintained irrespective of the fault location. For example, if using an autotransformer neutral current as a polarizing source, ensure that a reversal of the ground current does not occur for a high-side fault. Assume that the

low-side system impedance is minimal when checking for this condition. A similar situation arises for a wye/delta/wye transformer, where current in one transformer winding neutral can reverse when faults on both sides of the transformer are considered.

- If "Dual" polarizing is selected, the element performs both directional comparisons as described. A given direction is confirmed if either voltage or current comparators indicate so. If a conflicting (simultaneous forward and reverse) indication occurs, the forward direction overrides the reverse direction.
- If "Dual-V" polarizing is selected, "Voltage" polarizing is performed and "Current" polarizing is ignored if the voltage polarizing signal is valid; otherwise "Current" polarizing is performed if the current polarizing signal is valid. If neither of them is valid, neither forward nor reverse indication is given.
- If "Dual-I" polarizing is selected, "Current" polarizing is performed and "Voltage" polarizing is ignored if the current polarizing signal is valid; otherwise "Voltage" polarizing is performed if the voltage polarizing signal is valid. If neither of them is valid, neither forward nor reverse indication is given.

**NEUTRAL DIR OC1 POL VOLT** — Selects the polarizing voltage used by the directional unit when "Voltage," "Dual," "Dual-V," or "Dual-I" polarizing mode is set. The polarizing voltage can be programmed to be either the zero-sequence voltage calculated from the phase voltages ("Calculated V0") or supplied externally as an auxiliary voltage ("Measured VX").

**NEUTRAL DIR OC1 OP CURR** — This setting indicates whether the 3I<sub>0</sub> current calculated from the phase currents, or the ground current is used by this protection. This setting acts as a switch between the neutral and ground modes of operation (ANSI devices 67N and 67G). If set to "Calculated 3I<sub>0</sub>," the element uses the phase currents and applies the positive-sequence restraint. If set to "Measured IG," the element uses ground current supplied to the ground CT of the CT bank configured as **NEUTRAL DIR OC1 SOURCE**. If this setting is "Measured IG," then the **NEUTRAL DIR OC1 POLARIZING** setting must be "Voltage", as it is not possible to use the ground current as an operating and polarizing signal simultaneously. IG current has to be above 0.05 ps to be used as operate quantity.

**NEUTRAL DIR OC1 POS-SEQ RESTRAINT** — This setting controls the amount of the positive-sequence restraint. Set it to 0.063 for backward compatibility with firmware revision 3.40 and older. Set it to zero to remove the restraint. Set it higher if large system unbalances or poor CT performance are expected.

**NEUTRAL DIR OC1 OFFSET** — This setting specifies the offset impedance used by this protection. The primary application for the offset impedance is to guarantee correct identification of fault direction on series compensated lines. In regular applications, the offset impedance ensures proper operation even if the zero-sequence voltage at the relaying point is very small. If this is the intent, the offset impedance is not to be larger than the zero-sequence impedance of the protected circuit. Practically, it shall be several times smaller. Enter the offset impedance in secondary ohms.

**NEUTRAL DIR OC1 FWD ECA** — This setting defines the characteristic angle (ECA) for the forward direction in the "Voltage" polarizing mode. The "Current" polarizing mode uses a fixed ECA of 0°. The ECA in the reverse direction is the angle set for the forward direction shifted by 180°.

**NEUTRAL DIR OC1 FWD LIMIT ANGLE** — This setting defines a symmetrical (in both directions from the ECA) limit angle for the forward direction.

**NEUTRAL DIR OC1 FWD PICKUP** — This setting defines the pickup level for the overcurrent unit of the element in the forward direction. When selecting this setting, keep in mind that the design uses a positive-sequence restraint technique for the "Calculated 3I<sub>0</sub>" mode of operation.

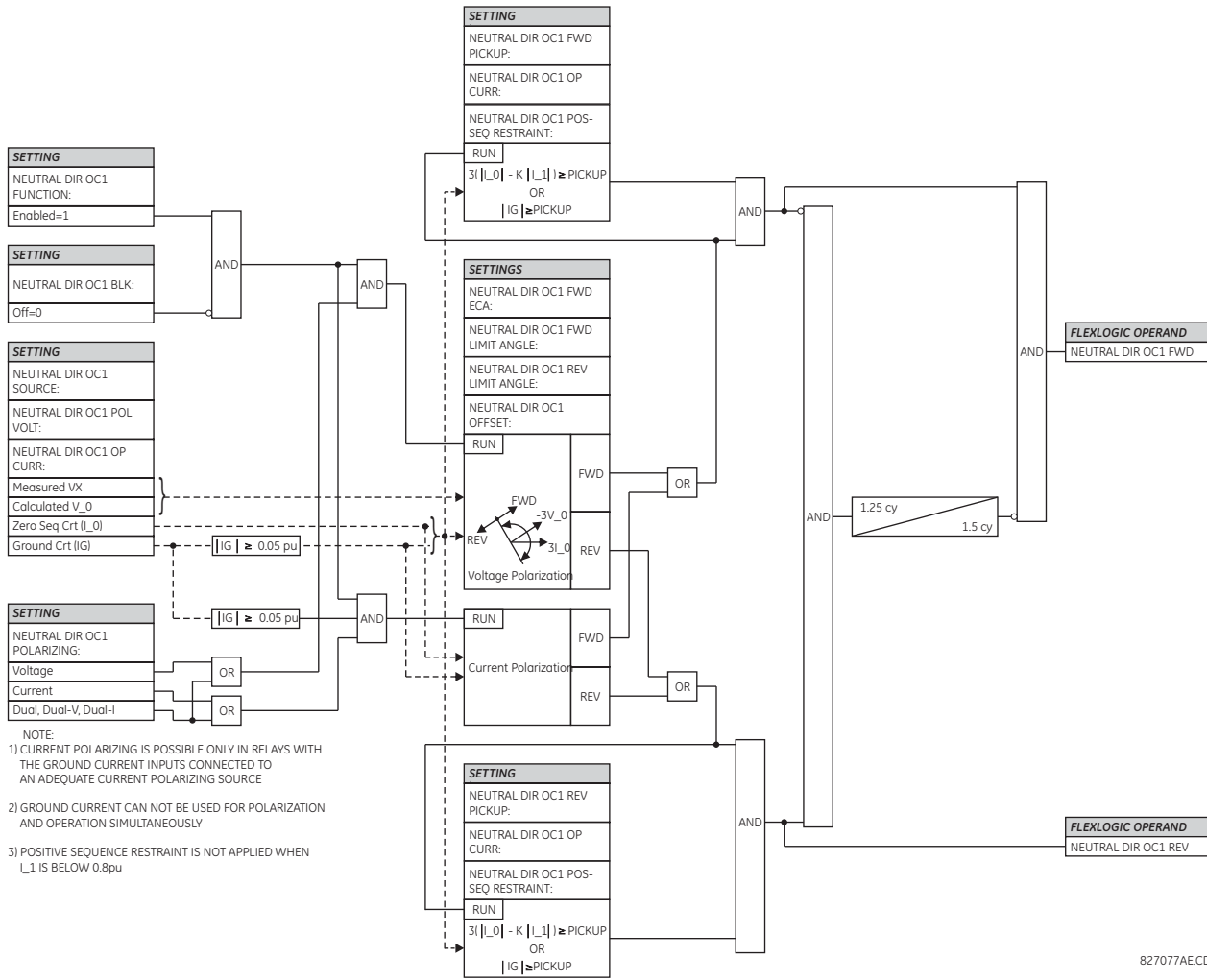
**NEUTRAL DIR OC1 REV LIMIT ANGLE** — This setting defines a symmetrical (in both directions from the ECA) limit angle for the reverse direction.

**NEUTRAL DIR OC1 REV PICKUP** — This setting defines the pickup level for the overcurrent unit of the element in the reverse direction. When selecting this setting, keep in mind that the design uses a positive-sequence restraint technique for the "Calculated 3I<sub>0</sub>" mode of operation.



Proper application of this element requires that the operating current and the polarizing voltage (or current) be measured from the same side of the transformer.

Figure 5-115: Neutral directional overcurrent logic

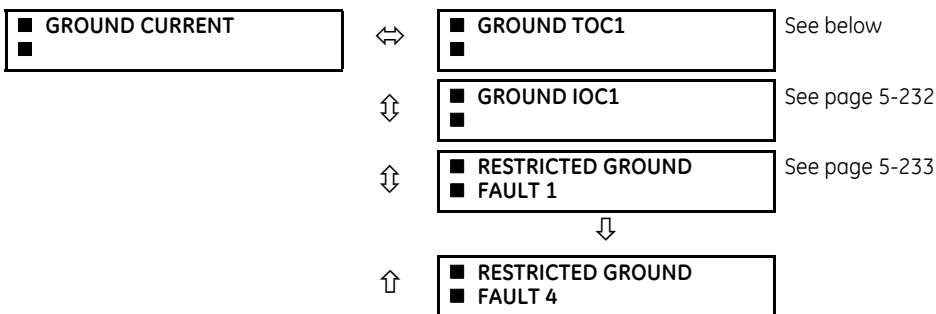


5

## 5.7.6 Ground current

### 5.7.6.1 Menu

SETTINGS ⇌ GROUPED ELEMENTS ⇌ SETTING GROUP 1(6) ⇌ GROUND CURRENT



The G30 relay contains one Ground Time Overcurrent, one Ground Instantaneous Overcurrent, and four Restricted Ground Fault elements. See the Inverse TOC Curve Characteristics section earlier for information.



### 5.7.6.2 Ground time overcurrent (ANSI 51G, IEC PTOC)

SETTINGS ⇒ ↓ GROUPED ELEMENTS ⇒ SETTING GROUP 1(6) ⇒ ↓ GROUND CURRENT ⇒ GROUND TOC1

■ GROUND TOC1	↔	GROUND TOC1 FUNCTION: Disabled	Range: Disabled, Enabled
■	↕	GROUND TOC1 SIGNAL SOURCE: SRC 1	Range: SRC 1, SRC 2, SRC 3, SRC 4
	↕	GROUND TOC1 INPUT: Phasor	Range: Phasor, RMS
	↕	GROUND TOC1 PICKUP: 1.000 pu	Range: 0.020 to 30.000 pu in steps of 0.001
	↕	GROUND TOC1 CURVE: IEEE Mod Inv	Range: see the Overcurrent Curve Types table
	↕	GROUND TOC1 TD MULTIPLIER: 1.00	Range: 0.00 to 600.00 in steps of 0.01
	↕	GROUND TOC1 RESET: Instantaneous	Range: Instantaneous, Timed
	↕	GROUND TOC1 BLOCK: Off	Range: FlexLogic operand
	↕	GROUND TOC1 TARGET: Self-reset	Range: Self-reset, Latched, Disabled
	↑	GROUND TOC1 EVENTS: Disabled	Range: Disabled, Enabled

This element can provide a required time-delay operating characteristic versus the applied current or be used as a simple definite time element. The ground current input value is the quantity measured by the ground input CT and is the fundamental phasor or RMS magnitude. Two methods of resetting operation are available: “Timed” and “Instantaneous” (see the Inverse TOC Curve Characteristics section for details). When the element is blocked, the time accumulator resets according to the reset characteristic. For example, if the element reset characteristic is set to “Instantaneous” and the element is blocked, the time accumulator clears immediately.

**GROUND TOC1 FUNCTION** — This setting enables and disables the ground time overcurrent protection element.

**GROUND TOC1 SIGNAL SOURCE** — This setting selects the signal source for the ground time overcurrent protection element.

**GROUND TOC1 INPUT** — This setting selects how ground current input quantities are interpreted by the G30. Inputs can be selected as fundamental phasor magnitudes or total waveform RMS magnitudes as required by the application.

**GROUND TOC1 PICKUP** — This setting specifies the ground time overcurrent pickup level in per-unit values.

**GROUND TOC1 CURVE** — This setting selects the inverse time overcurrent curve style.

**GROUND TOC1 TD MULTIPLIER** — This setting specifies a multiple of the base curve shape specified by the **CURVE** setting. Programming this value to zero results in an instantaneous response to all current levels above pickup.

**GROUND TOC1 RESET** — The “Instantaneous” reset method is intended for applications with other relays, such as most static relays, which set the energy capacity directly to zero when the current falls below the reset threshold. The “Timed” reset method can be used where the relay must coordinate with electromechanical relays.

**GROUND TOC1 BLOCK** — Assertion of the operand assigned to this setting blocks operation of the ground time overcurrent element.

**GROUND TOC1 EVENTS** — This setting enables and disables the logging of ground time overcurrent events in the sequence of events recorder.



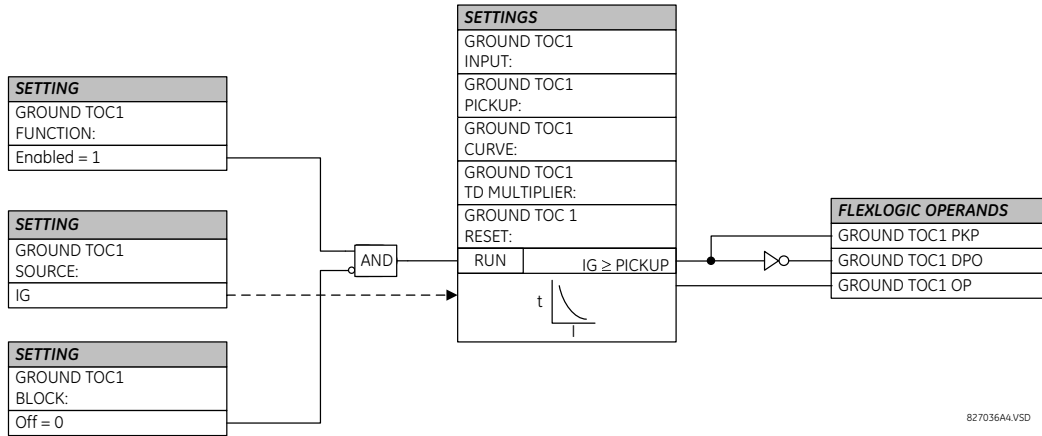
These elements measure the current that is connected to the ground channel of a CT/VT module. The conversion range of a standard channel is from 0.02 to 46 times the CT rating.

NOTE



This channel can be also equipped with a sensitive input. The conversion range of a sensitive channel is from 0.002 to 4.6 times the CT rating.

Figure 5-116: Ground TOC1 logic



827036A4.VSD

### 5.7.6.3 Ground instantaneous overcurrent (ANSI 50G, IEC PIOC)

SETTINGS ⇌ GROUPED ELEMENTS ⇌ SETTING GROUP 1(6) ⇌ GROUND CURRENT ⇌ GROUND IOC1

<div style="background-color: #0056b3; color: white; padding: 5px; font-weight: bold; font-size: 24px; margin-bottom: 10px;">5</div> <div style="border: 1px solid black; padding: 5px;"> <p>■ GROUND IOC1</p> <p>■</p> </div>	↔	<p>GROUND IOC1 FUNCTION: Disabled</p>	Range: Disabled, Enabled
	↕	<p>GROUND IOC1 SIGNAL SOURCE: SRC 1</p>	Range: SRC 1, SRC 2, SRC 3, SRC 4
	↕	<p>GROUND IOC1 PICKUP: 1.000 pu</p>	Range: 0.020 to 30.000 pu in steps of 0.001
	↕	<p>GROUND IOC1 PICKUP DELAY: 0.00 s</p>	Range: 0.00 to 600.00 s in steps of 0.01
	↕	<p>GROUND IOC1 RESET DELAY: 0.00 s</p>	Range: 0.00 to 600.00 s in steps of 0.01
	↕	<p>GROUND IOC1 BLOCK: Off</p>	Range: FlexLogic operand
	↕	<p>GROUND IOC1 TARGET: Self-reset</p>	Range: Self-reset, Latched, Disabled
	↑	<p>GROUND IOC1 EVENTS: Disabled</p>	Range: Disabled, Enabled

The ground instantaneous overcurrent element can be used as an instantaneous element with no intentional delay or as a definite time element. The ground current input is the quantity measured by the ground input CT and is the fundamental phasor magnitude.

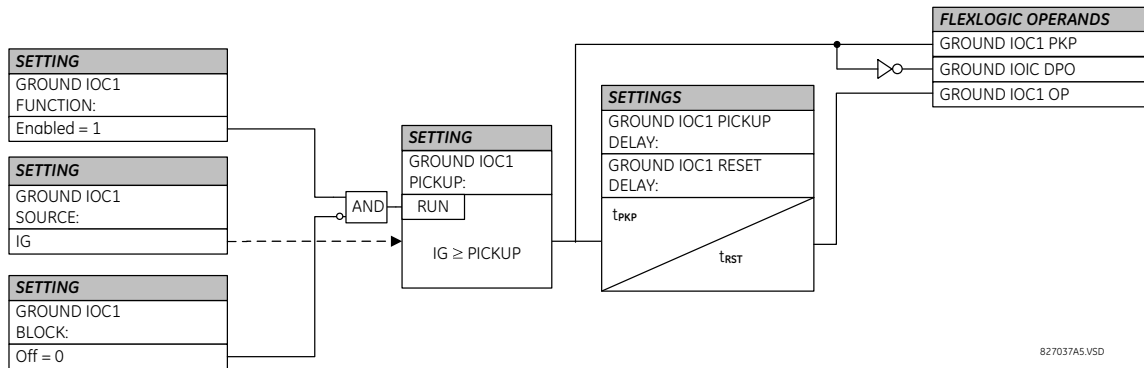


These elements measure the current that is connected to the ground channel of a CT/VT module. The conversion range of a standard channel is from 0.02 to 46 times the CT rating.



This channel can be equipped with a standard or sensitive input. The conversion range of a sensitive channel is from 0.002 to 4.6 times the CT rating.

Figure 5-117: Ground IOC1 logic



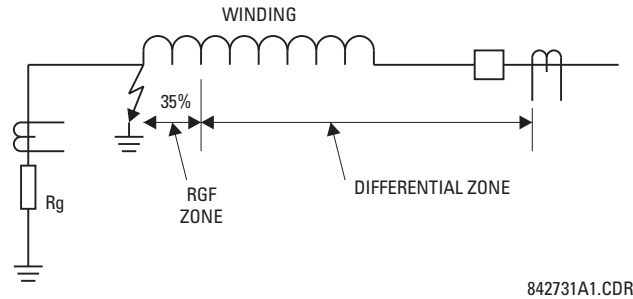
5.7.6.4 Restricted ground fault (ANSI 87RGF, IEC PPDF)

SETTINGS ⇒ GROUPED ELEMENTS ⇒ SETTING GROUP 1(6) ⇒ GROUND CURRENT ⇒ RESTRICTED GROUND FAULT 1(4)

■ RESTRICTED GROUND ■ FAULT 1	↔	RESTD GND FT1 FUNCTION: Disabled	Range: Disabled, Enabled
	↕	RESTD GND FT1 SOURCE: SRC 1	Range: SRC 1, SRC 2, SRC 3, SRC 4
	↕	RESTD GND FT1 PICKUP: 0.080 pu	Range: 0.005 to 30.000 pu in steps of 0.001
	↕	RESTD GND FT1 SLOPE: 40%	Range: 0 to 100% in steps of 1
	↕	RESTD GND FT1 PICKUP DELAY: 0.10 s	Range: 0.00 to 600.00 s in steps of 0.01
	↕	RESTD GND FT1 RESET DELAY: 0.00 s	Range: 0.00 to 600.00 s in steps of 0.01
	↕	RESTD GND FT1 BLOCK: Off	Range: FlexLogic operand
	↑	RESTD GND FT1 TARGET: Self-reset	Range: Self-reset, Latched, Disabled

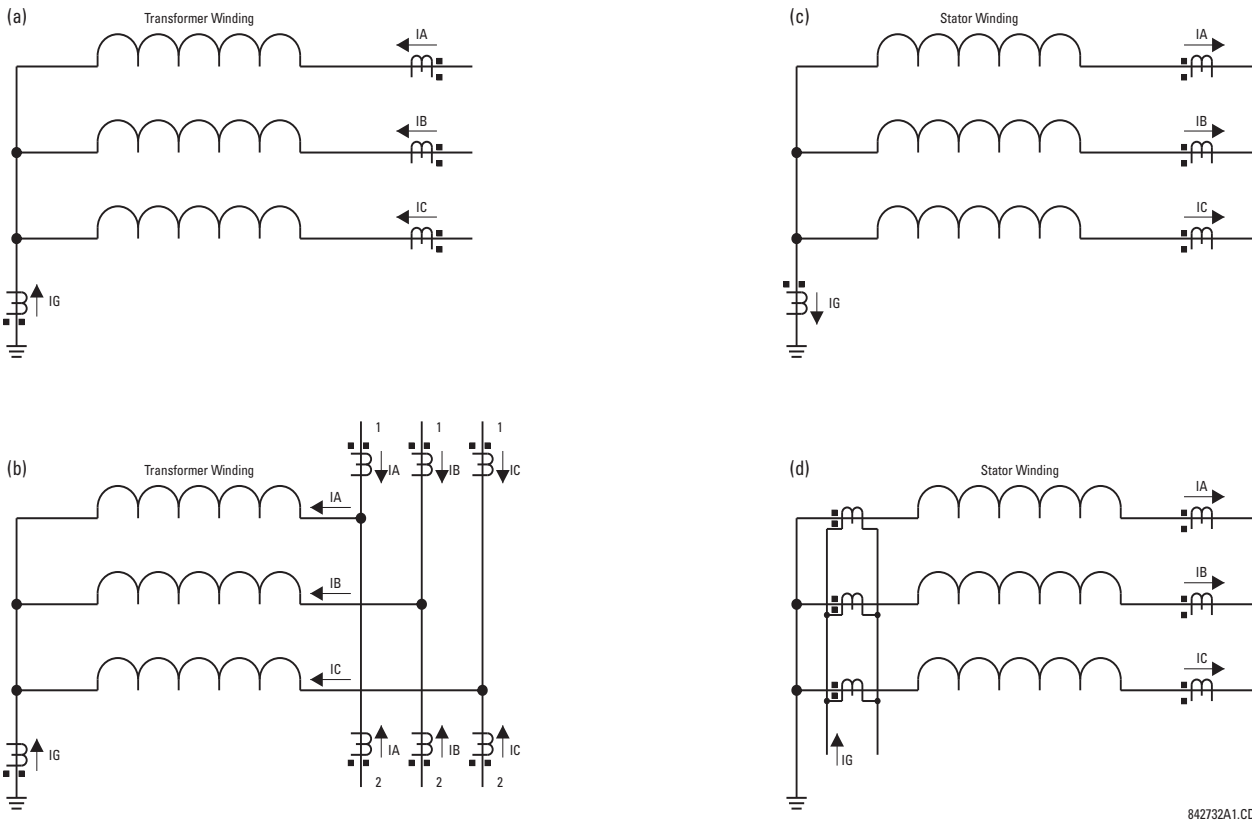
Restricted ground fault (RGF) protection provides sensitive ground fault detection for low-magnitude fault currents, primarily faults close to the neutral point of a wye-connected winding. An internal ground fault on an impedance grounded wye winding produces a fault current dependent on the ground impedance value and the fault position on the winding with respect to the neutral point. The resultant primary current is negligible for faults on the lower 30% of the winding since the fault voltage is not the system voltage, but rather the result of the transformation ratio between the primary windings and the percentage of shorted turns on the secondary. Therefore, the resultant differential currents can be below the slope threshold of the main differential element and the fault can go undetected. Application of the restricted ground fault protection extends the coverage towards the neutral point (see the following figure).

Figure 5-118: RGF and percent differential zones of protection



This protection is often applied to transformers having impedance-grounded wye windings. The element can also be applied to the stator winding of a generator having the neutral point grounded with a CT installed in the grounding path, or the ground current obtained by external summation of the neutral-side stator CTs. The following figure shows the basic application and wiring rules.

Figure 5-119: Typical applications of RGF protection



The relay incorporates low-impedance restricted ground fault protection. This low-impedance form of protection faces potential stability problems. An external phase-to-phase fault is an ultimate case. Ideally, there is neither ground (IG) nor neutral ( $I_N = I_A + I_B + I_C$ ) current present. If one or more of the phase CTs saturate, a spurious neutral current is seen by the relay. This is similar to a single infeed situation and can be mistaken for an internal fault. Similar difficulties occur in a breaker-and-a-half application of the restricted ground fault, where any through fault with a weak infeed from the winding itself can cause problems.

The UR uses a novel definition of the restraining signal to cope with the above stability problems while providing fast and sensitive protection. Even with the improved definition of the restraining signal, the breaker-and-a-half application of the restricted ground fault must be approached with care, and is not recommended unless the settings are carefully selected to avoid maloperation due to CT saturation.

The differential current is produced as an unbalance current between the ground current of the neutral CT ( $I_G$ ) and the neutral current derived from the phase CTs ( $I_N = I_A + I_B + I_C$ ):

$$I_{gd} = |I_G + I_N| = |I_G + I_A + I_B + I_C| \quad \text{Eq. 5-42}$$

The relay automatically matches the CT ratios between the phase and ground CTs by re-scaling the ground CT to the phase CT level. The restraining signal ensures stability of protection during CT saturation conditions and is produced as a maximum value between three components related to zero, negative, and positive-sequence currents of the three phase CTs as follows:

$$I_{rest} = \max(|I_{R0}, I_{R1}, I_{R2}|) \quad \text{Eq. 5-43}$$

The zero-sequence component of the restraining signal ( $I_{R0}$ ) is meant to provide maximum restraint during external ground faults, and therefore is calculated as a vectorial difference of the ground and neutral currents:

$$I_{R0} = |I_G - I_N| = |I_G - (I_A + I_B + I_C)| \quad \text{Eq. 5-44}$$

The equation above brings an advantage of generating the restraining signal of twice the external ground fault current, while reducing the restraint below the internal ground fault current. The negative-sequence component of the restraining signal ( $I_{R2}$ ) is meant to provide maximum restraint during external phase-to-phase faults and is calculated as follows:

$$I_{R2} = |I_{-2}| \text{ or } I_{R2} = 3 \times |I_{-2}| \quad \text{Eq. 5-45}$$

Following complete de-energization of the windings (all three phase currents below 5% of nominal for at least five cycles), the relay uses a multiplier of 1 in preparation for the next energization. The multiplier of 3 is used during normal operation; that is, two cycles after the winding has been energized. The lower multiplier is used to ensure better sensitivity when energizing a faulty winding.

The positive-sequence component of the restraining signal ( $I_{R1}$ ) is meant to provide restraint during symmetrical conditions, either symmetrical faults or load, and is calculated according to the following algorithm:

- 1 If  $|I_{-1}| > 2$  pu of phase CT, then
- 2 If  $|I_{-1}| > |I_{-0}|$ , then  $I_{R1} = 3 \times (|I_{-1}| - |I_{-0}|)$
- 3 else  $I_{R1} = 0$
- 4 else  $I_{R1} = |I_{-1}|/8$

Under load-level currents (below 200% of nominal), the positive-sequence restraint is set to 1/8th of the positive-sequence current (line 4). This is to ensure maximum sensitivity during low-current faults under full load conditions. Under fault-level currents (above 200% of nominal), the positive-sequence restraint is removed if the zero-sequence component is greater than the positive-sequence (line 3), or set at the net difference of the two (line 2).

The raw restraining signal ( $I_{rest}$ ) is further post-filtered for better performance during external faults with heavy CT saturation and for better switch-off transient control:

$$I_{gr}(k) = \max(I_{rest}(k), \alpha \times I_{gr}(k - 1)) \quad \text{Eq. 5-46}$$

where

$k$  represents a present sample

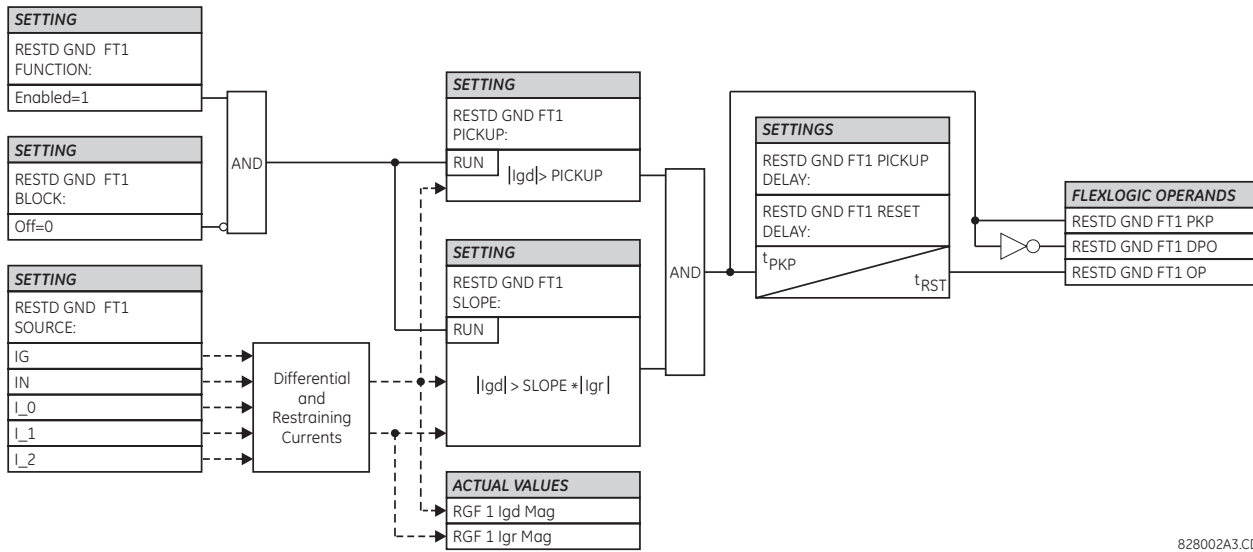
$k - 1$  represents the previous sample

$\alpha$  is a factory constant ( $\alpha < 1$ )

The equation above introduces a decaying memory to the restraining signal. Should the raw restraining signal ( $I_{rest}$ ) disappear or drop significantly, such as when an external fault gets cleared or a CT saturates heavily, the actual restraining signal ( $I_{gr}(k)$ ) does not reduce instantly but keeps decaying decreasing its value by 50% each 15.5 power system cycles.

Having the differential and restraining signals developed, the element applies a single slope differential characteristic with a minimum pickup as shown in the following logic diagram.

Figure 5-120: Restricted ground fault logic



828002A3.CDR

The following examples explain how the restraining signal is created for maximum sensitivity and security. These examples clarify the operating principle and provide guidance for testing of the element.

5

**Example 1: External single-line-to-ground fault**

Given the following inputs:  $I_A = 1 \text{ pu } \angle 0^\circ$ ,  $I_B = 0$ ,  $I_C = 0$ , and  $I_G = 1 \text{ pu } \angle 180^\circ$

The relay calculates the following values:

$$I_{gd} = 0, I_{R0} = \text{abs}\left(3 \times \frac{1}{3} - (-1)\right) = 2 \text{ pu}, I_{R2} = 3 \times \frac{1}{3} = 1 \text{ pu}, I_{R1} = \frac{1/3}{8} = 0.042 \text{ pu}, \text{ and } I_{gr} = 2 \text{ pu}$$

The restraining signal is twice the fault current. This gives extra margin if the phase or neutral CT saturates.

**Example 2: External high-current SLG fault**

Given the following inputs:  $I_A = 10 \text{ pu } \angle 0^\circ$ ,  $I_B = 0$ ,  $I_C = 0$ , and  $I_G = 10 \text{ pu } \angle -180^\circ$

The relay calculates the following values:

$$I_{gd} = 0, I_{R0} = \text{abs}\left(3 \times \frac{1}{3} - (-10)\right) = 20 \text{ pu}, I_{R2} = 3 \times \frac{10}{3} = 10 \text{ pu}, I_{R1} = 3 \times \left(\frac{10}{3} - \frac{10}{3}\right) = 0, \text{ and } I_{gr} = 20 \text{ pu}$$

**Example 3: External high-current three-phase symmetrical fault**

Given the following inputs:  $I_A = 10 \text{ pu } \angle 0^\circ$ ,  $I_B = 10 \text{ pu } \angle -120^\circ$ ,  $I_C = 10 \text{ pu } \angle 120^\circ$ , and  $I_G = 0 \text{ pu}$

The relay calculates the following values:

$$I_{gd} = 0, I_{R0} = \text{abs}(3 \times 0 - (0)) = 0 \text{ pu}, I_{R2} = 3 \times 0 = 0 \text{ pu}, I_{R1} = 3 \times \left(\frac{10}{3} - 0\right) = 10 \text{ pu}, \text{ and } I_{gr} = 10 \text{ pu}$$

**Example 4: Internal low-current single-line-to-ground fault under full load**

Given the following inputs:  $I_A = 1.10 \text{ pu } \angle 0^\circ$ ,  $I_B = 1.0 \text{ pu } \angle -120^\circ$ ,  $I_C = 1.0 \text{ pu } \angle 120^\circ$ , and  $I_G = 0.05 \text{ pu } \angle 0^\circ$

The relay calculates the following values:

$$I_{_0} = 0.033 \text{ pu } \angle 0^\circ, I_{_2} = 0.033 \text{ pu } \angle 0^\circ, \text{ and } I_{_1} = 1.033 \text{ pu } \angle 0^\circ$$

$$I_{gd} = \text{abs}(3 \times 0.0333 + 0.05) = 0.15 \text{ pu}, I_{R0} = \text{abs}(3 \times 0.033 - (0.05)) = 0.05 \text{ pu}, I_{R2} = 3 \times 0.033 = 0.10 \text{ pu},$$

$$I_{R1} = 1.033 / 8 = 0.1292 \text{ pu}, \text{ and } I_{gr} = 0.1292 \text{ pu}$$

Despite very low fault current level, the differential current is above 100% of the restraining current.

### Example 5: Internal low-current, high-load single-line-to-ground fault with no feed from the ground

Given the following inputs:  $I_A = 1.10 \text{ pu } \angle 0^\circ$ ,  $I_B = 1.0 \text{ pu } \angle -120^\circ$ ,  $I_C = 1.0 \text{ pu } \angle 120^\circ$ , and  $I_G = 0.0 \text{ pu } \angle 0^\circ$

The relay calculates the following values:

$$I_{_0} = 0.033 \text{ pu } \angle 0^\circ, I_{_2} = 0.033 \text{ pu } \angle 0^\circ, \text{ and } I_{_1} = 1.033 \text{ pu } \angle 0^\circ$$

$$I_{gd} = \text{abs}(3 \times 0.0333 + 0.0) = 0.10 \text{ pu}, I_{R0} = \text{abs}(3 \times 0.033 - (0.0)) = 0.10 \text{ pu}, I_{R2} = 3 \times 0.033 = 0.10 \text{ pu},$$

$$I_{R1} = 1.033 / 8 = 0.1292 \text{ pu}, \text{ and } I_{gr} = 0.1292 \text{ pu}$$

Despite very low fault current level the differential current is above 75% of the restraining current.

### Example 6: Internal high-current single-line-to-ground fault with no feed from the ground

Given the following inputs:  $I_A = 10 \text{ pu } \angle 0^\circ$ ,  $I_B = 0 \text{ pu}$ ,  $I_C = 0 \text{ pu}$ , and  $I_G = 0 \text{ pu}$

The relay calculates the following values:

$$I_{_0} = 3.3 \text{ pu } \angle 0^\circ, I_{_2} = 3.3 \text{ pu } \angle 0^\circ, \text{ and } I_{_1} = 3.3 \text{ pu } \angle 0^\circ$$

$$I_{gd} = \text{abs}(3 \times 3.3 + 0.0) = 10 \text{ pu}, I_{R0} = \text{abs}(3 \times 3.3 - (0.0)) = 10 \text{ pu}, I_{R2} = 3 \times 3.3 = 10 \text{ pu}, I_{R1} = 3 \times (3.33 - 3.33) = 0 \text{ pu}, \text{ and}$$

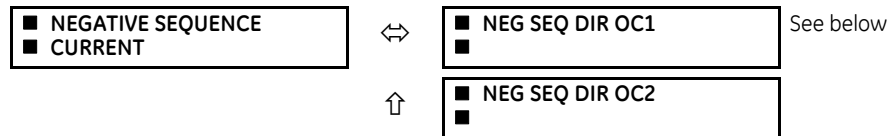
$$I_{gr} = 10 \text{ pu}$$

The differential current is 100% of the restraining current.

## 5.7.7 Negative sequence current

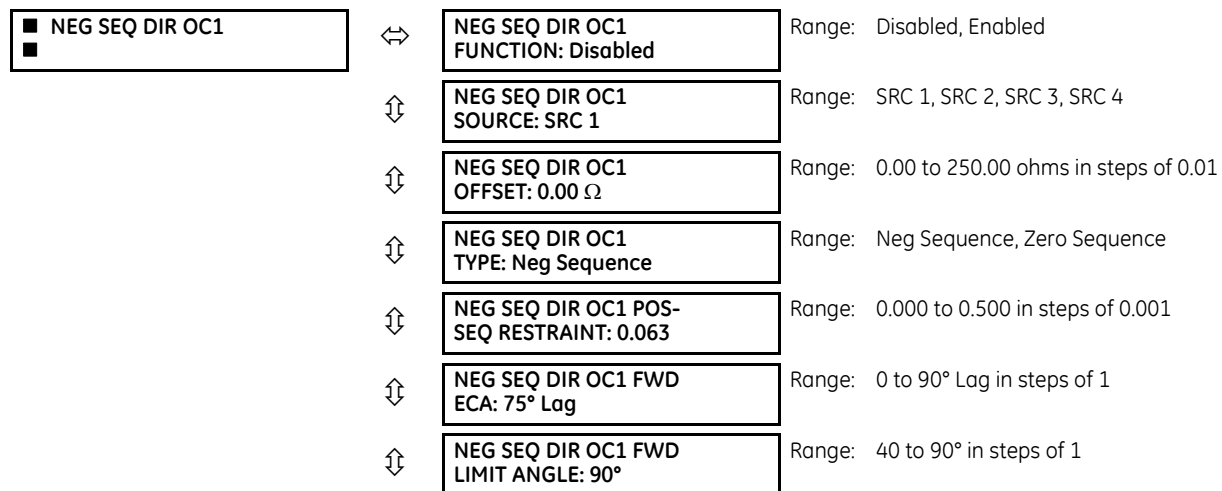
### 5.7.7.1 Menu

SETTINGS ⇒ GROUPED ELEMENTS ⇒ SETTING GROUP 1(6) ⇒ NEGATIVE SEQUENCE CURRENT



### 5.7.7.2 Negative sequence directional overcurrent (ANSI 67Q, IEC PDEF/PTOC)

SETTINGS ⇒ GROUPED ELEMENTS ⇒ SETTING GROUP 1(6) ⇒ NEGATIVE SEQUENCE CURRENT ⇒ NEG SEQ DIR OC1(2)



⇕	NEG SEQ DIR OC1 FWD PICKUP: 0.050 pu	Range: 0.015 to 30.000 pu in steps of 0.005
⇕	NEG SEQ DIR OC1 REV LIMIT ANGLE: 90°	Range: 40 to 90° in steps of 1
⇕	NEG SEQ DIR OC1 REV PICKUP: 0.050 pu	Range: 0.015 to 30.000 pu in steps of 0.005
⇕	NEG SEQ DIR OC1 BLK: Off	Range: FlexLogic operand
⇕	NEG SEQ DIR OC1 TARGET: Self-reset	Range: Self-reset, Latched, Disabled
↑	NEG SEQ DIR OC1 EVENTS: Disabled	Range: Disabled, Enabled

There are two negative-sequence directional overcurrent protection elements available. The element provides both forward and reverse fault direction indications through its output operands **NEG SEQ DIR OC1 FWD** and **NEG SEQ DIR OC1 REV**, respectively. The output operand is asserted if the magnitude of the operating current is above a pickup level (overcurrent unit) and the fault direction is seen as forward or reverse, respectively (directional unit).

The overcurrent unit of the element essentially responds to the magnitude of a fundamental frequency phasor of either the negative-sequence or neutral current as per user selection.

A positive-sequence restraint is applied for better performance: a small user-programmable portion of the positive-sequence current magnitude is subtracted from the negative or zero-sequence current magnitude, respectively, when forming the element operating quantity.

$$I_{op} = |I_{-2}| - K \times |I_{-1}| \text{ or } I_{op} = 3 \times (|I_{-0}| - K \times |I_{-1}|) \tag{Eq. 5-47}$$

The positive-sequence restraint allows for more sensitive settings by counterbalancing spurious negative-sequence and zero-sequence currents resulting from

- System unbalances under heavy load conditions
- Transformation errors of current transformers (CTs)
- Fault inception and switch-off transients

The positive-sequence restraint must be considered when testing for pickup accuracy and response time (multiple of pickup). The positive-sequence restraint is removed for low currents. If the positive-sequence current is less than 0.8 pu, then the restraint is removed by changing the constant K to zero. This results in better response to high-resistance faults when the unbalance is very small and there is no danger of excessive CT errors, since the current is low.

The operating quantity depends on the way the test currents are injected into the G30. For single phase injection

- $I_{op} = \frac{1}{3} \times (1 - K) \times I_{injected}$  for I<sub>-2</sub> mode
- $I_{op} = (1 - K) \times I_{injected}$  for I<sub>-0</sub> mode if |I<sub>-1</sub>| > 0.8 pu

The directional unit uses the negative-sequence current (I<sub>-2</sub>) and negative-sequence voltage (V<sub>-2</sub>).

The following tables define the negative-sequence directional overcurrent element.

**Table 5-37: Negative-sequence directional overcurrent unit**

Mode	Operating current
Negative-sequence	$I_{op} =  I_{-2}  - K \times  I_{-1} $
Zero-sequence	$I_{op} = 3 \times ( I_{-0}  - K \times  I_{-1} )$ if $ I_{-1}  > 0.8$ pu $I_{op} = 3 \times  I_{-0} $ if $ I_{-1}  \leq 0.8$ pu

**Table 5-38: Negative-sequence directional unit**

Direction	Compared phasors
Forward	$-V_{-2} + Z_{offset} \times I_{-2}$   $I_{-2} \times 1 \angle ECA$
Reverse	$-V_{-2} + Z_{offset} \times I_{-2}$   $-(I_{-2} \times 1 \angle ECA)$

Z<sub>offset</sub> is the offset impedance, for which magnitude is the OFFSET setting and angle is the FWD ECA.



The negative-sequence voltage must be greater than 0.02 pu to be validated for use as a polarizing signal. Additionally, when offset impedance is applied and negative-sequence current is above 0.2 pu, compensated negative-sequence voltage  $-V_2 + Z_{\text{offset}} \times I_2$  has to be above 0.02 pu in order to discriminate fault direction; otherwise when negative-sequence current is less than 0.2 pu,  $-V_2$  is then used as the polarizing signal. If the polarizing signal is not validated, neither forward nor reverse indication is given. The following figure explains the usage of the voltage polarized directional unit of the element. It shows the phase angle comparator characteristics for a phase A to ground fault, with settings of

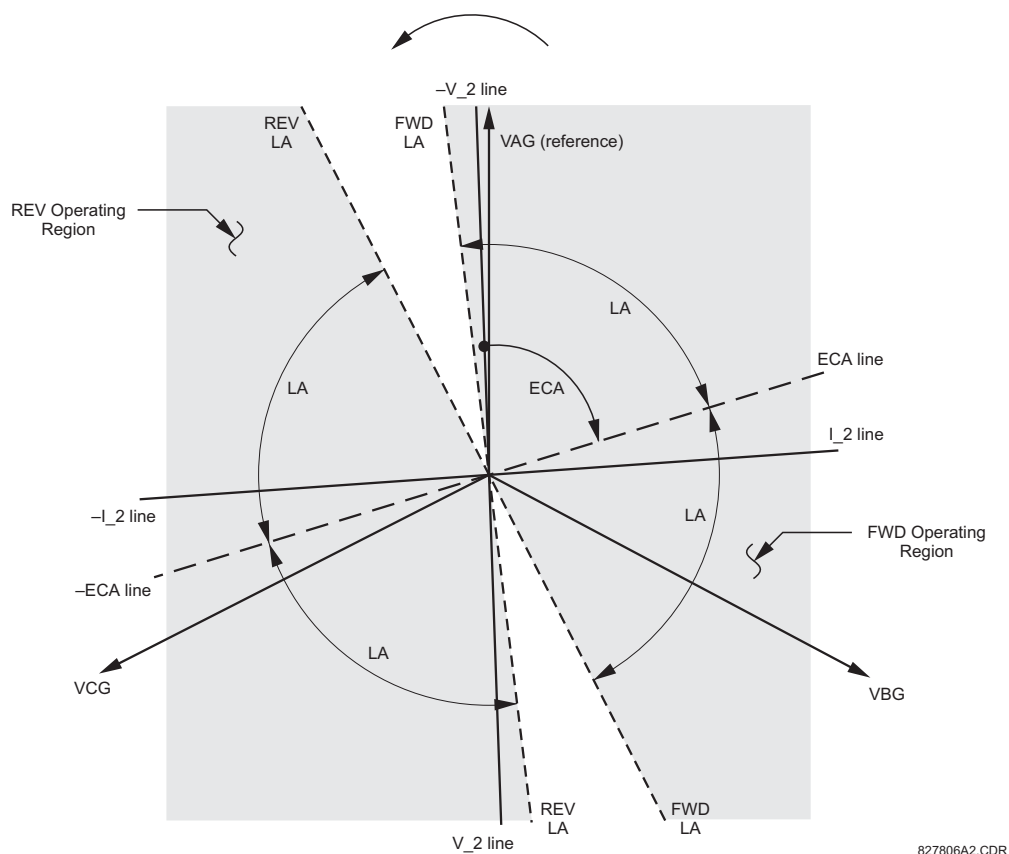
ECA =  $75^\circ$  (element characteristic angle = centerline of operating characteristic)

FWD LA =  $80^\circ$  (forward limit angle =  $\pm$  the angular limit with the ECA for operation)

REV LA =  $80^\circ$  (reverse limit angle =  $\pm$  the angular limit with the ECA for operation)

The element incorporates a current reversal logic: if the reverse direction is indicated for at least 1.25 of a power system cycle, the prospective forward indication is delayed by 1.5 of a power system cycle. The element emulates an electromechanical directional device. Larger operating and polarizing signals result in faster directional discrimination, bringing more security to the element operation.

Figure 5-121: Negative-sequence directional characteristic



The forward-looking function is designed to be more secure compared to the reverse-looking function, so use the forward-looking function for the tripping direction. The reverse-looking function is faster compared to the forward-looking function, so use the reverse-looking function for the blocking direction. This allows for better protection coordination. Take this bias into account when using the negative-sequence directional overcurrent element to directionalize other protection elements. The negative-sequence current must be greater than the **PRODUCT SETUP** ⇒ **DISPLAY PROPERTIES** ⇒ **CURRENT CUT-OFF LEVEL** setting value.

## Settings

**NEG SEQ DIR OC1 OFFSET** — Specifies the offset impedance used by this protection. The primary application for the offset impedance is to guarantee correct identification of fault direction on series compensated lines (see the Application of Settings chapter for information on how to calculate this setting). In regular applications, the offset impedance ensures

proper operation even if the negative-sequence voltage at the relaying point is very small. If this is the intent, the offset impedance shall not be larger than the negative-sequence impedance of the protected circuit. Practically, it is several times smaller. Enter the offset impedance in secondary ohms.

**NEG SEQ DIR OC1 TYPE** — Selects the operating mode for the overcurrent unit of the element. The choices are “Neg Sequence” and “Zero Sequence.” In some applications it is advantageous to use a directional negative-sequence overcurrent function instead of a directional zero-sequence overcurrent function as inter-circuit mutual effects are minimized.

**NEG SEQ DIR OC1 POS-SEQ RESTRAINT** — Controls the positive-sequence restraint. Set it to 0.063 (in “Zero Sequence” mode) or 0.125 (in “Neg Sequence” mode) for backward compatibility with revisions 3.40 and earlier. Set it to zero to remove the restraint. Set it higher if large system unbalances or poor CT performance are expected.

**NEG SEQ DIR OC1 FWD ECA** — Select the element characteristic angle (ECA) for the forward direction. The element characteristic angle in the reverse direction is the angle set for the forward direction shifted by 180°.

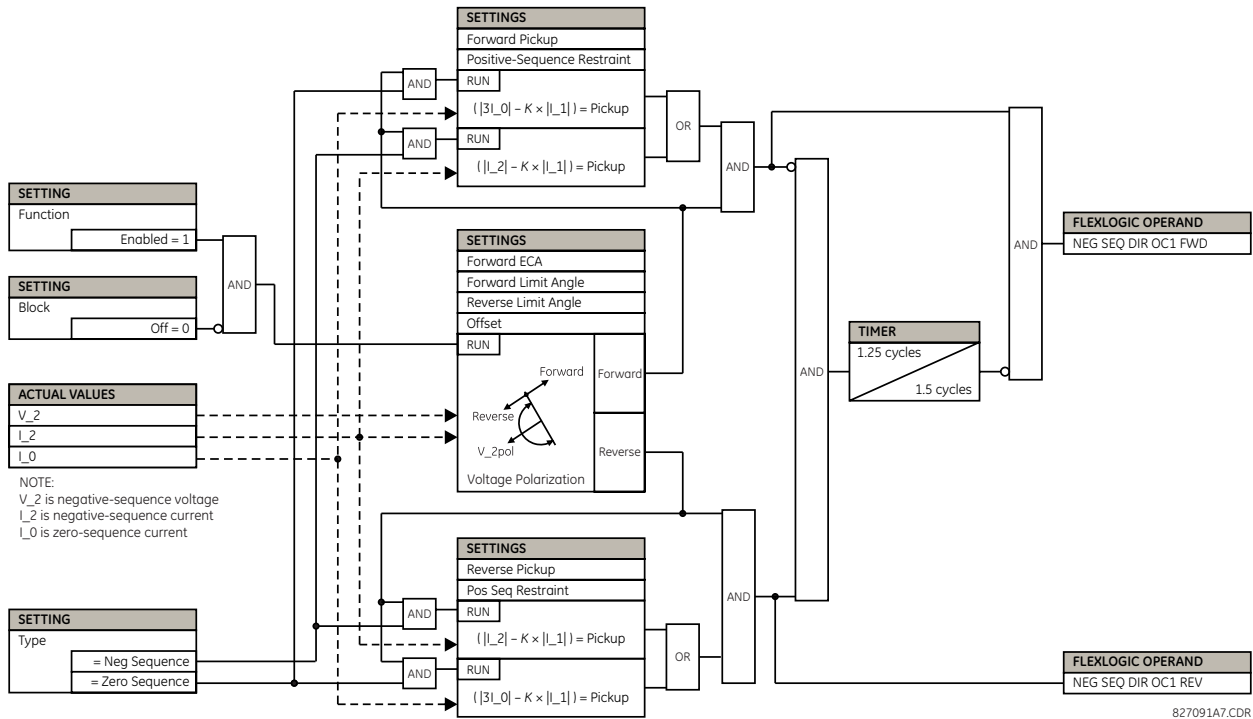
**NEG SEQ DIR OC1 FWD LIMIT ANGLE** — Defines a symmetrical limit angle (in both directions from the ECA) for the forward direction.

**NEG SEQ DIR OC1 FWD PICKUP** — Defines the pickup level for the overcurrent unit in the forward direction. This pickup threshold applies to zero-sequence or negative-sequence current based on the **NEG SEQ DIR OC1 TYPE** setting. When specifying this setting, keep in mind that the design uses a positive-sequence restraint technique.

**NEG SEQ DIR OC1 REV LIMIT ANGLE** — Defines a symmetrical limit angle (in both directions from the ECA) for the reverse direction.

**NEG SEQ DIR OC1 REV PICKUP** — Defines the pickup level for the overcurrent unit in the reverse direction. This pickup threshold applies to zero-sequence or negative-sequence current based on the **NEG SEQ DIR OC1 TYPE** setting. When selecting this setting, keep in mind that the design uses a positive-sequence restraint technique.

Figure 5-122: Negative-sequence directional OC1 logic



## 5.7.8 Generator unbalance (ANSI 46)

SETTINGS ⇒ GROUPED ELEMENTS ⇒ SETTING GROUP 1(6) ⇒ GENERATOR UNBALANCE

<input checked="" type="checkbox"/> GENERATOR <input checked="" type="checkbox"/> UNBALANCE	↔	GENERATOR UNBAL FUNCTION: Disabled	Range: Disabled, Enabled
	⇅	GEN UNBAL SOURCE: SRC 1	Range: SRC 1, SRC 2, SRC 3, SRC 4
	⇅	GEN UNBAL INOM: 0.800 pu	Range: 0.000 to 1.250 pu in steps of 0.001
	⇅	GEN UNBAL STG1 PICKUP: 8.00%	Range: 0.00 to 100.00% in steps of 0.01
	⇅	GEN UNBAL STG1 K-VALUE: 1.00	Range: 0.00 to 100.00 in steps of 0.01
	⇅	GEN UNBAL STG1 TMIN: 0.250 s	Range: 0.000 to 50.000 s in steps of 0.001
	⇅	GEN UNBAL STG1 TMAX: 600.00 s	Range: 0.0 to 1000.0 s in steps of 0.1
	⇅	GEN UNBAL STG1 K-RESET: 240.00 s	Range: 0.0 to 1000.0 s in steps of 0.1
	⇅	GEN UNBAL STG2 PICKUP: 3.0%	Range: 0.00 to 100.00% in steps of 0.01
	⇅	GEN UNBAL STG2 PKP DELAY: 5.0 s	Range: 0.0 to 1000.0 s in steps of 0.1
	⇅	GEN UNBAL BLK: Off	Range: FlexLogic operand
	⇅	GEN UNBAL TARGET: Self-Reset	Range: Self-reset, Latched, Disabled
	↑	GEN UNBAL EVENTS: Disabled	Range: Enabled, Disabled

The generator unbalance element protects the machine from rotor damage due to excessive negative-sequence current. The element has an inverse time stage that is typically used for tripping and a definite time stage typically used for alarm purposes. The inverse time stage operating characteristic is defined by the following equation:

$$T = \frac{K}{(I_2/I_{nom})^2} \quad \text{Eq. 5-48}$$

where

$I_{nom}$  is the generator rated current

K is the negative-sequence capability constant normally provided by the generator manufacturer

**GEN UNBAL INOM** — This setting is the rated full load current of the machine.

**GEN UNBAL STG1 PICKUP** — Defines the pickup of the stage 1 element expressed as a percentage of the nominal current as specified by the **GEN UNBAL INOM** setting. It is set typically at the maximum continuous negative sequence current rating of the machine.

**GEN UNBAL STG1 K-VALUE** — The negative sequence capability constant. This value is normally provided by the generator manufacturer (see ANSI C50.13 for details).

**GEN UNBAL STG1 TMIN** — The minimum operate time of the stage 1 element. The stage does not operate before this time expires. This is set to prevent false trips for faults that would be cleared normally by system protections.

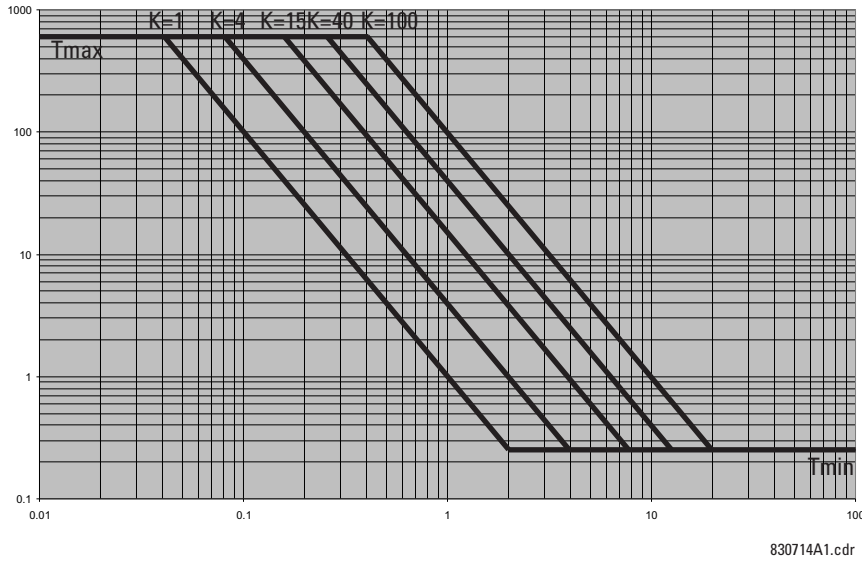
**GEN UNBAL STG1 TMAX** — The maximum operate time of the stage 1 element. This setting can be applied to limit the maximum tripping time for low level unbalances.

**GEN UNBAL STG1 K-RESET** — Defines the linear reset rate of the stage 1 element. It is the maximum reset time from the threshold of tripping. This feature provides a thermal memory of previous unbalance conditions.

**GEN UNBAL STG2 PICKUP** — Defines the pickup of the stage 2 element expressed as a percentage of the nominal current as specified by the **GEN UNBAL INOM** setting. The definite time element is used to generate an alarm to prompt an operator to take some corrective action. The stage 2 element is set typically at a safe margin below the stage 1 pickup setting.

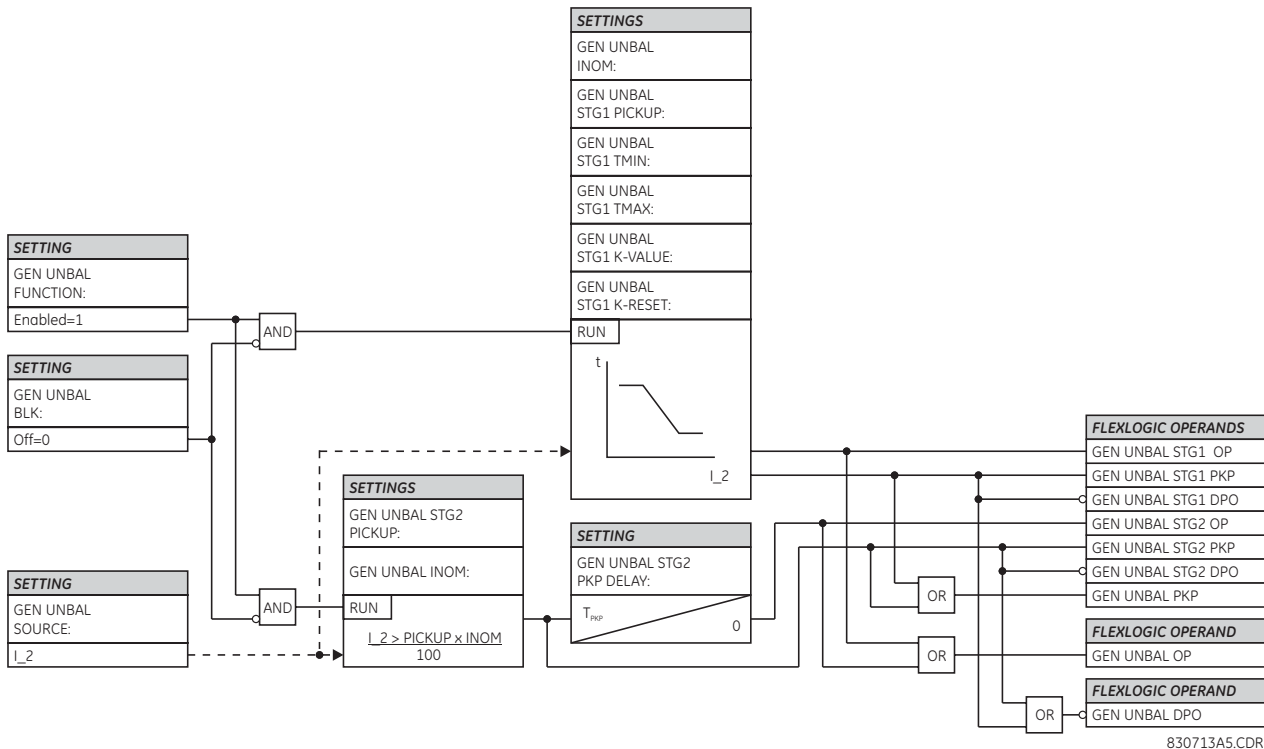
**GEN UNBAL STG2 PKP DELAY** — The minimum operate time of the stage 2 element. This is set to prevent nuisance alarms during system faults.

Figure 5-123: Generator unbalance inverse time curves



5

Figure 5-124: Generator unbalance logic



## 5.7.9 Split phase protection (ANSI 50SP)

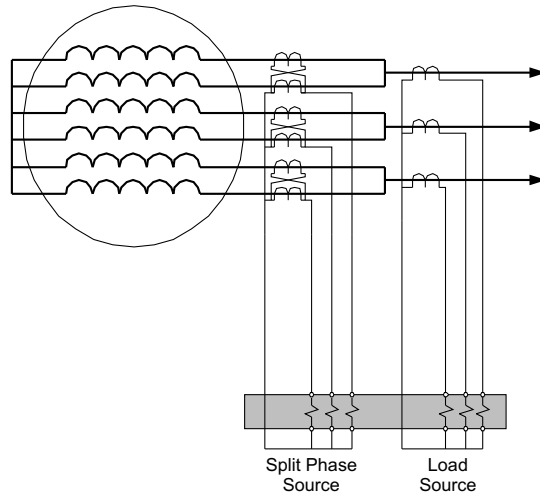
SETTINGS ⇒ GROUPED ELEMENTS ⇒ SETTING GROUP 1(6) ⇒ SPLIT PHASE

■ SPLIT PHASE	↔	SPLIT PHASE FUNCTION: Disabled	Range: Disabled, Enabled
	⇅	SPLIT PHASE SOURCE: SRC 1	Range: SRC 1, SRC 2, SRC 3, SRC 4
	⇅	SPLIT PHASE LOAD SOURCE: SRC 2	Range: SRC 1, SRC 2, SRC 3, SRC 4
	⇅	SPLIT PHASE A PICKUP: 0.200 pu	Range: 0.020 to 1.500 pu in steps of 0.001
	⇅	SPLIT PHASE A OFFSET: 0.000 pu	Range: 0.000 to 1.000 pu in steps of 0.001
	⇅	SPLIT PHASE A SLOPE: 0.0%	Range: 0.0 to 100% in steps of 0.1
	⇅	SPLIT PHASE B PICKUP: 0.200 pu	Range: 0.020 to 1.500 pu in steps of 0.001
	⇅	SPLIT PHASE B OFFSET: 0.000 pu	Range: 0.000 to 1.000 pu in steps of 0.001
	⇅	SPLIT PHASE B SLOPE: 0.0%	Range: 0.0 to 100% in steps of 0.1
	⇅	SPLIT PHASE C PICKUP: 0.200 pu	Range: 0.020 to 1.500 pu in steps of 0.001
	⇅	SPLIT PHASE C OFFSET: 0.000 pu	Range: 0.000 to 1.000 pu in steps of 0.001
	⇅	SPLIT PHASE C SLOPE: 0.0%	Range: 0.0 to 100% in steps of 0.1
	⇅	SPLIT PHASE MIN LOAD: 0.00 pu	Range: 0.00 to 1.00 pu in steps of 0.01
	⇅	SPLIT PHASE MODE: Over	Range: Over, Over-Under
	⇅	SPLIT PHASE DELAY: 0.000 s	Range: 0.000 to 65.535 s in steps of 0.001
	⇅	SPLIT PHASE BLK: Off	Range: FlexLogic operand
	⇅	SPLIT PHASE TARGET: Self-Reset	Range: Self-reset, Latched, Disabled
	↑	SPLIT PHASE EVENTS: Disabled	Range: Enabled, Disabled

Some generators, due to physical construction, have windings that consist of multiple adjacent turns. It is therefore possible for faults to develop between turns on the same phase (inter-turn faults). These faults are not detected by the stator differential protection, as there is no difference between the neutral and at-terminal currents. Split phase protection can be applied to detect inter-turn faults when the generator is wound with two three-phase windings, each brought separately out of the machine and connected in parallel. The currents in the two windings are compared, any difference indicating an inter-turn fault.

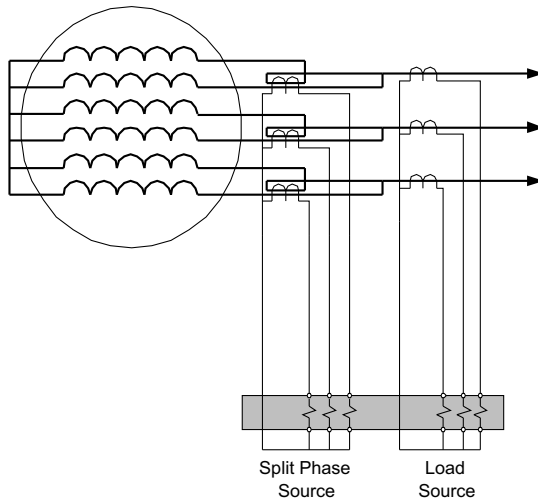
The split phase element allows a separate pickup setting to be applied for each phase. Additionally, the pickup can be biased by the load current (slope characteristic). Two modes of operation are supported (over and over-under).

Figure 5-125: Split phase protection for two CTs



830728A1.CDR

Figure 5-126: Split phase protection for one CT



830727A1.CDR

5

The split phase element principle of operation is as follows. First, define the following parameters:

$I_{split}$  = split-phase current

$I_{load}$  = load current

pickup = pickup setting

min\_load = minimum load supervision setting

Then, the expected value of the steady state unbalance (defined as bias current) is expressed as follows:

$$I_{bias} = slope \times I_{load} + offset \tag{Eq. 5-49}$$

where

$$slope = \frac{I_{split}}{I_{load}} \times \frac{Load\ CT\ Primary}{Load\ CT\ Secondary} \times \frac{Split\ Phase\ CT\ Secondary}{Split\ Phase\ CT\ Primary} \tag{Eq. 5-50}$$

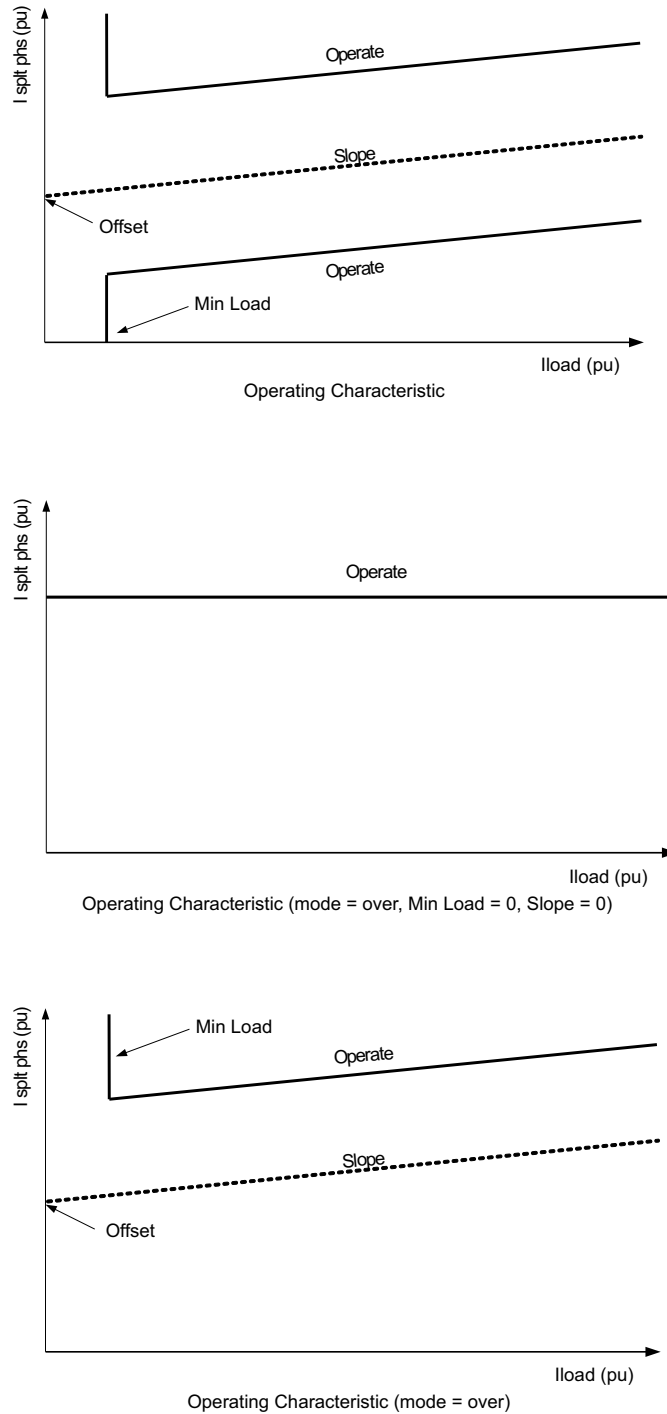
and offset is the split phase current at no-load. In "Over" mode, the element picks up if

$$(|I_{split} - I_{bias}| > pickup) \text{ and } (I_{load} \geq min\_load) \tag{Eq. 5-51}$$

In "Over-under" mode, the element picks up if

$$(|I_{split} - I_{bias}| > pickup) \text{ and } (I_{load} \geq min\_load) \tag{Eq. 5-52}$$

Figure 5-127: Split phase protection operating characteristics



830729A1.CDR

Settings are described as follows.

**SPLIT PHASE FUNCTION** — This setting enables and disables the function.

**SPLIT PHASE SOURCE** — Specifies a signal source used to provide current from the split phase CT to the split phase protection.

**SPLIT PHASE LOAD SOURCE** — Specifies a signal source used to provide current from the load CT to the split phase protection.

**SPLIT PHASE A(IC) PICKUP** — Specifies a pickup level for each phase. Set it less than the minimum expected unbalance (split phase) current due to an inter-turn fault.

**SPLIT PHASE A(IC) OFFSET** — Specifies the steady-state split phase current at no-load for the each phase. Set it equal to the split phase current during normal (unfaulted) operation. Assign the split phase current and the load current (positive sequence) to the data logger to identify the optimum value for this setting.

**SPLIT PHASE A(IC) SLOPE** — Specifies the slope of split phase characteristic for each phase. This setting is used to bias the pickup of the element due to variations in generator loading. The slope is defined as the ratio of the per-unit split phase current over the per-unit load current. Assign the split phase current and the load current (positive sequence) to the data logger to identify the optimum value for this setting.

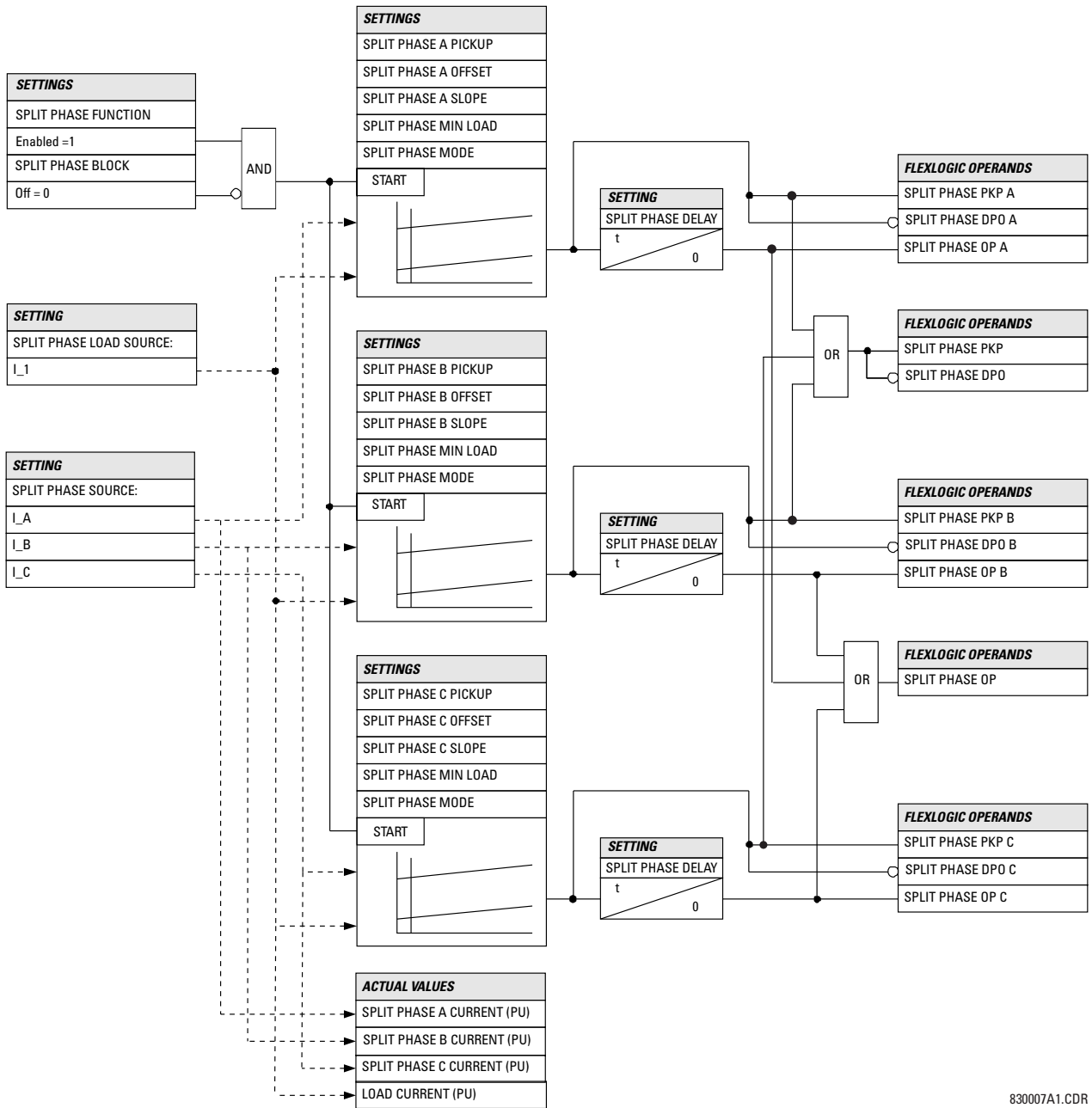
**SPLIT PHASE MIN LOAD** — Specifies the minimum load (positive-sequence current) supervision level.

**SPLIT PHASE MODE** — Specifies the mode of operation. If the “Over” mode is chosen, the element picks up when the split phase current rises above the biased offset current plus the pickup setting. If “Over-under” mode is chosen, the element also picks up if the split phase current falls below the biased offset current minus the pickup setting. See the earlier description for details.

**SPLIT PHASE DELAY** — Specifies a time delay required to operate after the pickup condition is established. During an external disturbance the CTs can saturate. CT saturation can cause a spurious split phase current, especially in the case where the split phase current is derived from the external summation of two split phase CTs (first figure presented). In this instance, a time delay can be used to ride through the saturation event. Alternately, the CT saturation flag also can be used to supervise the function.



Figure 5-128: Split phase protection logic

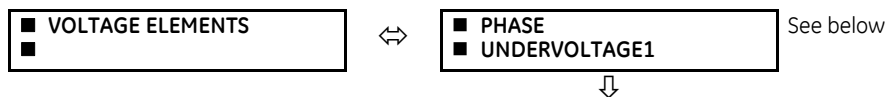


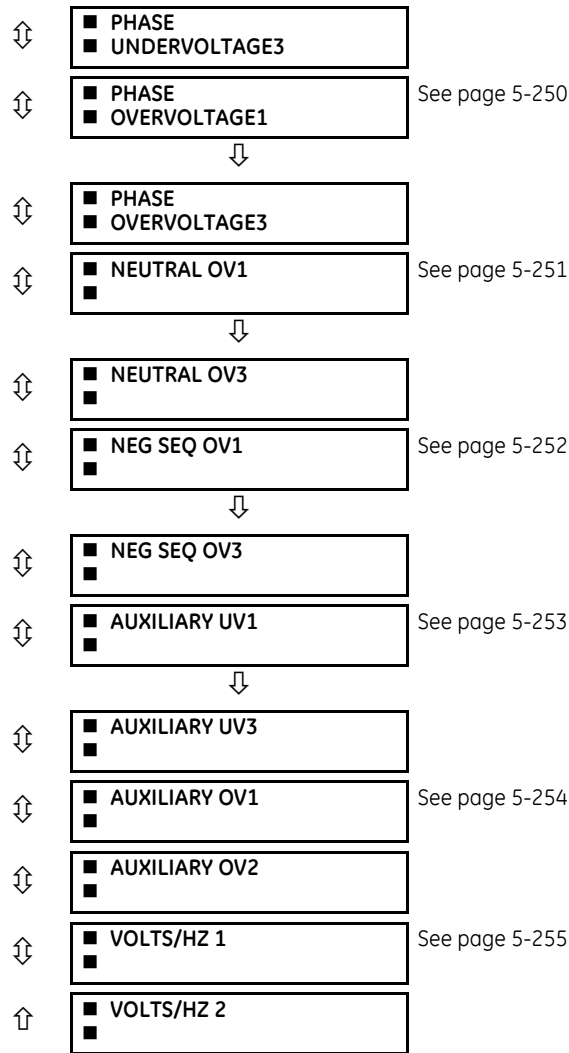
830007A1.CDR

### 5.7.10 Voltage elements

#### 5.7.10.1 Menu

SETTINGS ⇄ GROUPED ELEMENTS ⇄ SETTING GROUP 1(6) ⇄ VOLTAGE ELEMENTS





These protection elements can be used for a variety of applications, such as

- **Undervoltage protection** — For voltage sensitive loads, such as induction motors, a drop in voltage increases the drawn current, which can cause dangerous overheating in the motor. The undervoltage protection feature can be used to either cause a trip or generate an alarm when the voltage drops below a specified voltage setting for a specified time delay.
- **Permissive functions** — The undervoltage feature can be used to block the functioning of external devices by operating an output relay when the voltage falls below the specified voltage setting. The undervoltage feature can also be used to block the functioning of other elements through the block feature of those elements.
- **Source transfer schemes** — In the event of an undervoltage, a transfer signal can be generated to transfer a load from its normal source to a standby or emergency power source.

The undervoltage elements can be programmed to have a definite time delay characteristic. The definite time curve operates when the voltage drops below the pickup level for a specified period of time. The time delay is adjustable from 0 to 600.00 seconds in steps of 0.01. The undervoltage elements can also be programmed to have an inverse time delay characteristic.

The undervoltage delay setting defines the family of curves shown as follows.

$$T = \frac{D}{\left(1 - \frac{V}{V_{pickup}}\right)} \tag{Eq. 5-53}$$

where

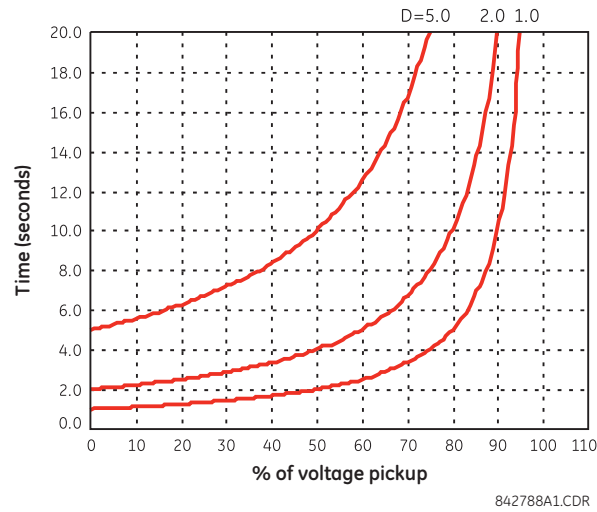
T = operating time

D = undervoltage delay setting (D = 0.00 operates instantaneously)

V = secondary voltage applied to the relay

$V_{pickup}$  = pickup level

Figure 5-129: Inverse time undervoltage curves



At 0% of pickup, the operating time equals the PHASE UNDERVOLTAGE DELAY setting.

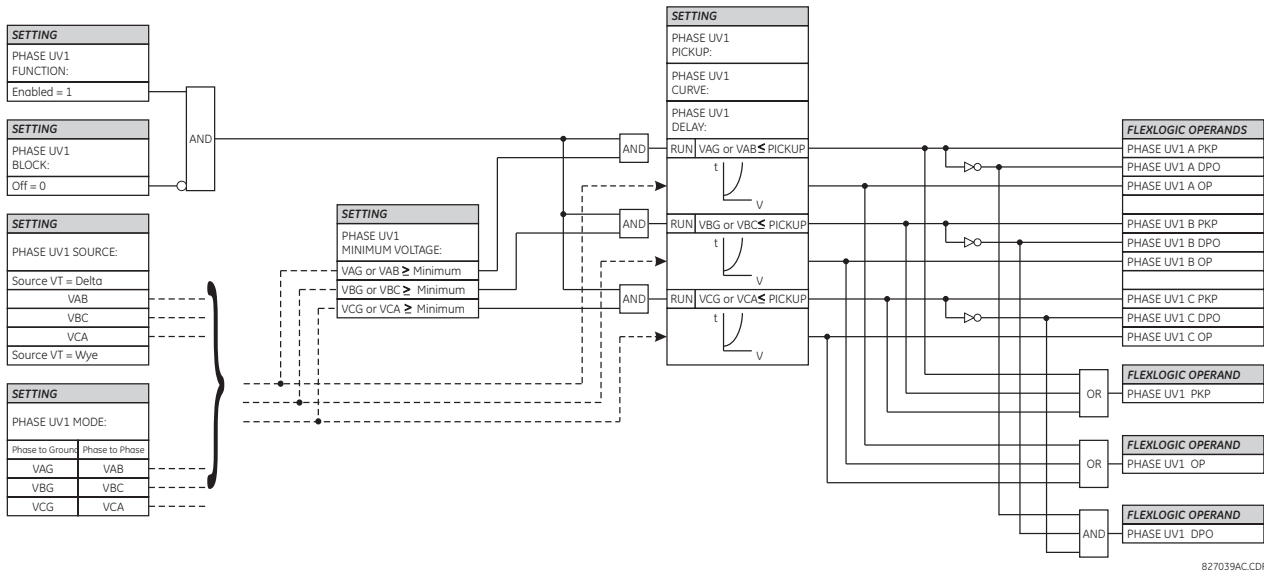
### 5.7.10.2 Phase undervoltage (ANSI 27P, IEC PTUV)

SETTINGS ⇒ GROUPED ELEMENTS ⇒ SETTING GROUP 1(6) ⇒ VOLTAGE ELEMENTS ⇒ PHASE UNDERVOLTAGE1(3)

<ul style="list-style-type: none"> <li>■ PHASE</li> <li>■ UNDERVOLTAGE1</li> </ul>	↔	PHASE UV1 FUNCTION: Disabled	Range: Disabled, Enabled
	↕	PHASE UV1 SIGNAL SOURCE: SRC 1	Range: SRC 1, SRC 2, SRC 3, SRC 4
	↕	PHASE UV1 MODE: Phase to Ground	Range: Phase to Ground, Phase to Phase
	↕	PHASE UV1 PICKUP: 1.000 pu	Range: 0.004 to 3.000 pu in steps of 0.001
	↕	PHASE UV1 CURVE: Definite Time	Range: Definite Time, Inverse Time
	↕	PHASE UV1 DELAY: 1.00 s	Range: 0.00 to 600.00 s in steps of 0.01
	↕	PHASE UV1 MINIMUM VOLTAGE: 0.100 pu	Range: 0.000 to 3.000 pu in steps of 0.001
	↕	PHASE UV1 BLOCK: Off	Range: FlexLogic operand
	↕	PHASE UV1 TARGET: Self-reset	Range: Self-reset, Latched, Disabled
	↑	PHASE UV1 EVENTS: Disabled	Range: Disabled, Enabled

This element is used to give a time-delay operating characteristic versus the applied fundamental voltage (phase-to-ground or phase-to-phase for wye VT connection, or phase-to-phase for delta VT connection) or as a definite time element. The element resets instantaneously if the applied voltage exceeds the dropout voltage. The delay setting selects the minimum operating time of the phase undervoltage. The minimum voltage setting selects the operating voltage below which the element is blocked (a setting of "0" allows a dead source to be considered a fault condition).

Figure 5-130: Phase undervoltage1 logic



5

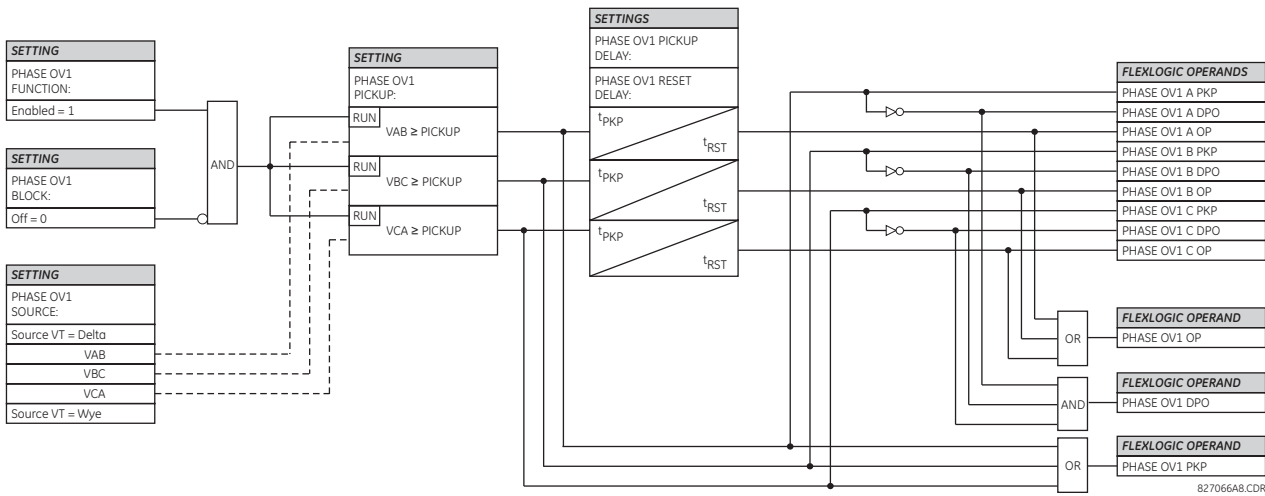
5.7.10.3 Phase overvoltage (ANSI 59P, IEC PTOV)

SETTINGS ⇌ GROUPED ELEMENTS ⇌ SETTING GROUP 1(6) ⇌ VOLTAGE ELEMENTS ⇌ PHASE OVERVOLTAGE1(3)

<ul style="list-style-type: none"> <li>■ PHASE</li> <li>■ OVERVOLTAGE1</li> </ul>	⇌	<table border="1"> <tr> <td>PHASE OV1 FUNCTION: Disabled</td> <td>Range: Disabled, Enabled</td> </tr> </table>	PHASE OV1 FUNCTION: Disabled	Range: Disabled, Enabled
PHASE OV1 FUNCTION: Disabled	Range: Disabled, Enabled			
	⇌	<table border="1"> <tr> <td>PHASE OV1 SIGNAL SOURCE: SRC 1</td> <td>Range: SRC 1, SRC 2, SRC 3, SRC 4</td> </tr> </table>	PHASE OV1 SIGNAL SOURCE: SRC 1	Range: SRC 1, SRC 2, SRC 3, SRC 4
PHASE OV1 SIGNAL SOURCE: SRC 1	Range: SRC 1, SRC 2, SRC 3, SRC 4			
	⇌	<table border="1"> <tr> <td>PHASE OV1 PICKUP: 1.000 pu</td> <td>Range: 0.004 to 3.000 pu in steps of 0.001</td> </tr> </table>	PHASE OV1 PICKUP: 1.000 pu	Range: 0.004 to 3.000 pu in steps of 0.001
PHASE OV1 PICKUP: 1.000 pu	Range: 0.004 to 3.000 pu in steps of 0.001			
	⇌	<table border="1"> <tr> <td>PHASE OV1 PICKUP DELAY: 1.00 s</td> <td>Range: 0.00 to 600.00 s in steps of 0.01</td> </tr> </table>	PHASE OV1 PICKUP DELAY: 1.00 s	Range: 0.00 to 600.00 s in steps of 0.01
PHASE OV1 PICKUP DELAY: 1.00 s	Range: 0.00 to 600.00 s in steps of 0.01			
	⇌	<table border="1"> <tr> <td>PHASE OV1 RESET DELAY: 1.00 s</td> <td>Range: 0.00 to 600.00 s in steps of 0.01</td> </tr> </table>	PHASE OV1 RESET DELAY: 1.00 s	Range: 0.00 to 600.00 s in steps of 0.01
PHASE OV1 RESET DELAY: 1.00 s	Range: 0.00 to 600.00 s in steps of 0.01			
	⇌	<table border="1"> <tr> <td>PHASE OV1 BLOCK: Off</td> <td>Range: FlexLogic Operand</td> </tr> </table>	PHASE OV1 BLOCK: Off	Range: FlexLogic Operand
PHASE OV1 BLOCK: Off	Range: FlexLogic Operand			
	⇌	<table border="1"> <tr> <td>PHASE OV1 TARGET: Self-reset</td> <td>Range: Self-reset, Latched, Disabled</td> </tr> </table>	PHASE OV1 TARGET: Self-reset	Range: Self-reset, Latched, Disabled
PHASE OV1 TARGET: Self-reset	Range: Self-reset, Latched, Disabled			
	⇌	<table border="1"> <tr> <td>PHASE OV1 EVENTS: Disabled</td> <td>Range: Disabled, Enabled</td> </tr> </table>	PHASE OV1 EVENTS: Disabled	Range: Disabled, Enabled
PHASE OV1 EVENTS: Disabled	Range: Disabled, Enabled			

There are three phase overvoltage elements available. A phase overvoltage element is used as an instantaneous element with no intentional time delay or as a definite time element. The input voltage is the phase-to-phase voltage, either measured directly from delta-connected VTs or as calculated from phase-to-ground (wye) connected VTs. The figure shows specific voltages to be used for each phase.

Figure 5-131: Phase overvoltage logic



**NOTE** If the source VT is wye-connected, then the phase overvoltage pickup condition is  $V > \sqrt{3} \times \text{Pickup}$  for  $V_{AB}$ ,  $V_{BC}$ , and  $V_{CA}$ .

### 5.7.10.4 Neutral overvoltage (ANSI 59N, IEC PTOV)

SETTINGS ⇒ GROUPED ELEMENTS ⇒ SETTING GROUP 1(6) ⇒ VOLTAGE ELEMENTS ⇒ NEUTRAL OV1(3)

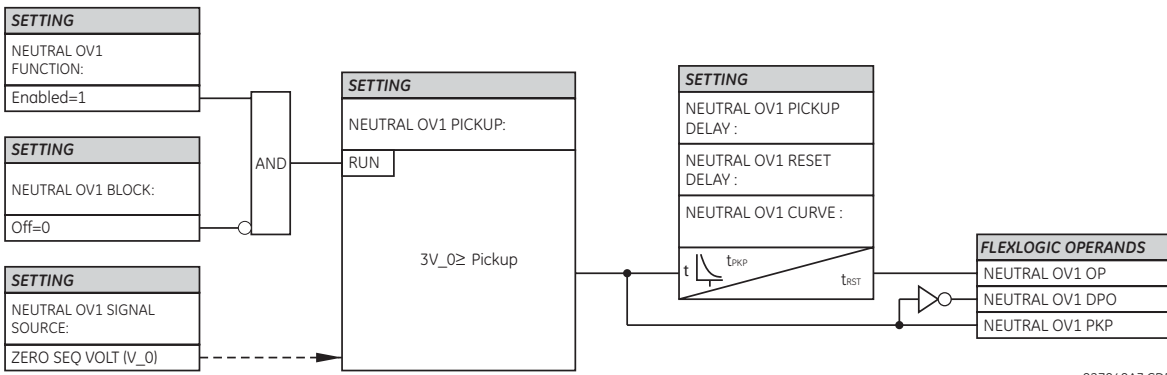
■ NEUTRAL OV1	↔	NEUTRAL OV1 FUNCTION: Disabled	Range: Disabled, Enabled
■	↕	NEUTRAL OV1 SIGNAL SOURCE: SRC 1	Range: SRC 1, SRC 2, SRC 3, SRC 4
	↕	NEUTRAL OV1 PICKUP: 0.300 pu	Range: 0.004 to 3.000 pu in steps of 0.001
	↕	NEUTRAL OV1 CURVE: Definite Time	Range: Definite Time, FlexCurve A, FlexCurve B, FlexCurve C
	↕	NEUTRAL OV1 PICKUP DELAY: 1.00 s	Range: 0.00 to 600.00 s in steps of 0.01
	↕	NEUTRAL OV1 RESET DELAY: 1.00 s	Range: 0.00 to 600.00 s in steps of 0.01
	↕	NEUTRAL OV1 BLOCK: Off	Range: FlexLogic operand
	↕	NEUTRAL OV1 TARGET: Self-reset	Range: Self-reset, Latched, Disabled
	↑	NEUTRAL OV1 EVENTS: Disabled	Range: Disabled, Enabled

There are three neutral overvoltage elements available. The neutral overvoltage element can be used to detect asymmetrical system voltage condition due to a ground fault or to the loss of one or two phases of the source. The element responds to the system neutral voltage (3V<sub>0</sub>), calculated from the phase voltages. The nominal secondary voltage of the phase voltage channels entered under SETTINGS ⇒ SYSTEM SETUP ⇒ AC INPUTS ⇒ VOLTAGE BANK ⇒ PHASE VT SECONDARY is the p.u. base used when setting the pickup level.

The neutral overvoltage element can provide a time-delayed operating characteristic versus the applied voltage (initialized from FlexCurves A, B, or C) or be used as a definite time element. The NEUTRAL OV1 PICKUP DELAY setting applies only if the NEUTRAL OV1 CURVE setting is “Definite Time.” The source assigned to this element must be configured for a phase VT.

VT errors and normal voltage unbalance must be considered when setting this element. This function requires the VTs to be wye-connected.

Figure 5-132: Neutral overvoltage1 logic



827848A3.CDR

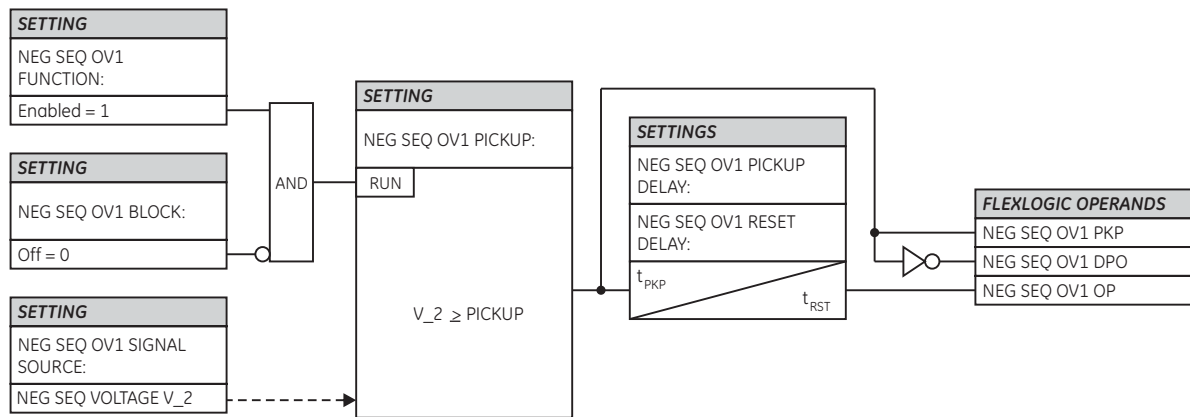
5.7.10.5 Negative sequence overvoltage (ANSI 59Q, IEC PTOV)

SETTINGS ⇒ GROUPED ELEMENTS ⇒ SETTING GROUP 1(6) ⇒ VOLTAGE ELEMENTS ⇒ NEG SEQ OV1(3)

■ NEG SEQ OV1	↔	NEG SEQ OV1 FUNCTION: Disabled	Range: Disabled, Enabled
■	↕	NEG SEQ OV1 SIGNAL SOURCE: SRC 1	Range: SRC 1, SRC 2, SRC 3, SRC 4
	↕	NEG SEQ OV1 PICKUP: 0.300 pu	Range: 0.004 to 1.250 pu in steps of 0.001
	↕	NEG SEQ OV1 PICKUP DELAY: 0.50 s	Range: 0.00 to 600.00 s in steps of 0.01
	↕	NEG SEQ OV1 RESET DELAY: 0.50 s	Range: 0.00 to 600.00 s in steps of 0.01
	↕	NEG SEQ OV1 BLOCK: Off	Range: FlexLogic operand
	↕	NEG SEQ OV1 TARGET: Self-reset	Range: Self-reset, Latched, Disabled
	↕	NEG SEQ OV1 EVENTS: Disabled	Range: Disabled, Enabled

There are three negative-sequence overvoltage elements available. Use the negative-sequence overvoltage element to detect loss of one or two phases of the source, a reversed phase sequence of voltage, or a non-symmetrical system voltage condition.

Figure 5-133: Negative-sequence overvoltage logic



827839A4.CDR

### 5.7.10.6 Auxiliary undervoltage (ANSI 27X, IEC PTUV)

SETTINGS ⇒ GROUPED ELEMENTS ⇒ SETTING GROUP 1(6) ⇒ VOLTAGE ELEMENTS ⇒ AUXILIARY UV1(3)

■ AUXILIARY UV1	↔	AUX UV1 FUNCTION: Disabled	Range: Disabled, Enabled
	↕	AUX UV1 SIGNAL SOURCE: SRC 1	Range: SRC 1, SRC 2, SRC 3, SRC 4
	↕	AUX UV1 PICKUP: 0.700 pu	Range: 0.004 to 3.000 pu in steps of 0.001
	↕	AUX UV1 CURVE: Definite Time	Range: Definite Time, Inverse Time
	↕	AUX UV1 DELAY: 1.00 s	Range: 0.00 to 600.00 s in steps of 0.01
	↕	AUX UV1 MINIMUM VOLTAGE: 0.100 pu	Range: 0.000 to 3.000 pu in steps of 0.001
	↕	AUX UV1 BLOCK: Off	Range: FlexLogic operand
	↕	AUX UV1 TARGET: Self-reset	Range: Self-reset, Latched, Disabled
	↑	AUX UV1 EVENTS: Disabled	Range: Disabled, Enabled

The G30 contains one auxiliary undervoltage element for each VT bank. This element monitors undervoltage conditions of the auxiliary voltage.

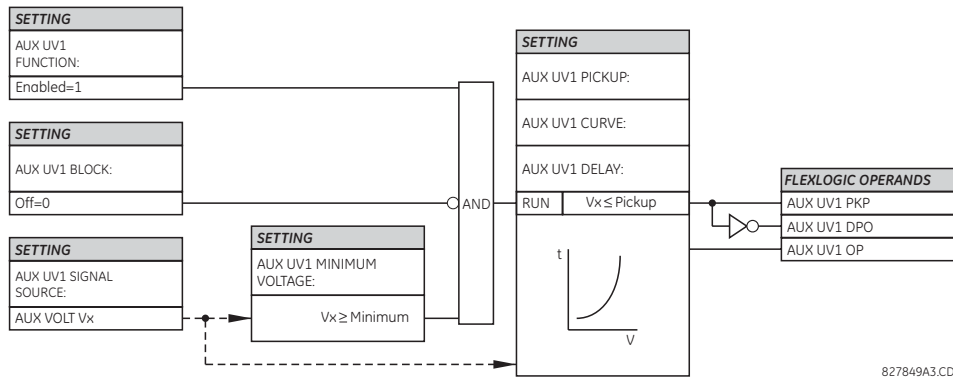
The **AUX UV1 PICKUP** selects the voltage level at which the time undervoltage element starts timing. The nominal secondary voltage of the auxiliary voltage channel entered under **SETTINGS ⇒ SYSTEM SETUP ⇒ AC INPUTS ⇒ VOLTAGE BANK X5 ⇒ AUXILIARY VT X5 SECONDARY** is the per-unit base used when setting the pickup level.

The **AUX UV1 DELAY** setting selects the minimum operating time of the auxiliary undervoltage element.

Both **AUX UV1 PICKUP** and **AUX UV1 DELAY** settings establish the operating curve of the undervoltage element. The auxiliary undervoltage element can be programmed to use either definite time delay or inverse time delay characteristics. The operating characteristics and equations for both definite and inverse time delay are as for the phase undervoltage element.

The element resets instantaneously. The minimum voltage setting selects the operating voltage below which the element is blocked.

Figure 5-134: Auxiliary undervoltage logic



827849A3.CDR

5.7.10.7 Auxiliary overvoltage (ANSI 59X, IEC PTOV)

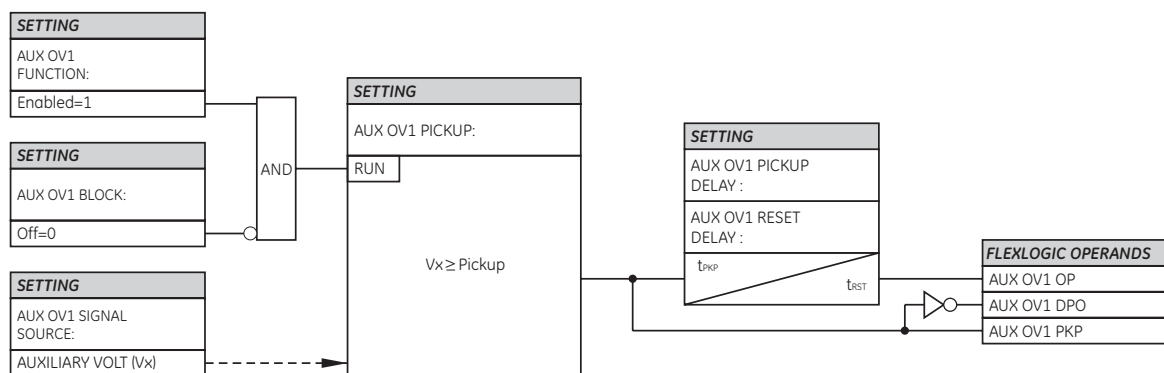
SETTINGS ⇒ GROUPED ELEMENTS ⇒ SETTING GROUP 1(6) ⇒ VOLTAGE ELEMENTS ⇒ AUXILIARY OV1(2)

<div style="border: 1px solid black; padding: 5px;"> <p>■ AUXILIARY OV1</p> </div>	↔	<div style="border: 1px solid black; padding: 5px;"> <p>AUX OV1 FUNCTION: Disabled</p> </div>	Range: Disabled, Enabled
	↕	<div style="border: 1px solid black; padding: 5px;"> <p>AUX OV1 SIGNAL SOURCE: SRC 1</p> </div>	Range: SRC 1, SRC 2, SRC 3, SRC 4
	↕	<div style="border: 1px solid black; padding: 5px;"> <p>AUX OV1 PICKUP: 0.300 pu</p> </div>	Range: 0.004 to 3.000 pu in steps of 0.001
	↕	<div style="border: 1px solid black; padding: 5px;"> <p>AUX OV1 PICKUP DELAY: 1.00 s</p> </div>	Range: 0.00 to 600.00 s in steps of 0.01
	↕	<div style="border: 1px solid black; padding: 5px;"> <p>AUX OV1 RESET DELAY: 1.00 s</p> </div>	Range: 0.00 to 600.00 s in steps of 0.01
	↕	<div style="border: 1px solid black; padding: 5px;"> <p>AUX OV1 BLOCK: Off</p> </div>	Range: FlexLogic operand
	↕	<div style="border: 1px solid black; padding: 5px;"> <p>AUX OV1 TARGET: Self-reset</p> </div>	Range: Self-reset, Latched, Disabled
	↑	<div style="border: 1px solid black; padding: 5px;"> <p>AUX OV1 EVENTS: Disabled</p> </div>	Range: Disabled, Enabled

The G30 contains one auxiliary overvoltage element for each VT bank. This element is intended for monitoring overvoltage conditions of the auxiliary voltage. The nominal secondary voltage of the auxiliary voltage channel entered under **SYSTEM SETUP ⇒ AC INPUTS ⇒ VOLTAGE BANK X5 ⇒ AUXILIARY VT X5 SECONDARY** is the per-unit (pu) base used when setting the pickup level.



Figure 5-135: Auxiliary overvoltage logic



827836A3.CDR

### 5.7.10.8 Volts per hertz (ANSI 24, IEC PVPH)

SETTINGS ⇒ GROUPED ELEMENTS ⇒ SETTING GROUP 1(6) ⇒ VOLTAGE ELEMENTS ⇒ VOLTS/HZ 1(2)

■ VOLTS/HZ 1	↔	VOLTS/HZ 1 FUNCTION: Disabled	Range: Disabled, Enabled
	⇅	VOLTS/HZ 1 SOURCE: SRC 1	Range: SRC 1, SRC 2, SRC 3, SRC 4
	⇅	VOLTS/HZ 1 VOLTAGE MODE: Phase-ground	Range: Phase-ground, Phase-phase
	⇅	VOLTS/HZ 1 PICKUP: 1.00 pu	Range: 0.80 to 4.00 pu in steps of 0.01
	⇅	VOLTS/HZ 1 CURVE: Definite Time	Range: Definite Time, Inverse A, Inverse B, Inverse C, FlexCurve A, FlexCurve B, FlexCurve C, FlexCurve D
	⇅	VOLTS/HZ 1 TD MULTIPLIER: 1.00	Range: 0.05 to 600.00 in steps of 0.01
	⇅	VOLTS/HZ 1 T-RESET: 1.0 s	Range: 0.0 to 1000.0 s in steps of 0.1
	⇅	VOLTS/HZ 1 BLOCK: Off	Range: FlexLogic operand
	⇅	VOLTS/HZ 1 TARGET: Self-reset	Range: Self-reset, Latched, Disabled
	↑	VOLTS/HZ 1 EVENTS: Disabled	Range: Disabled, Enabled

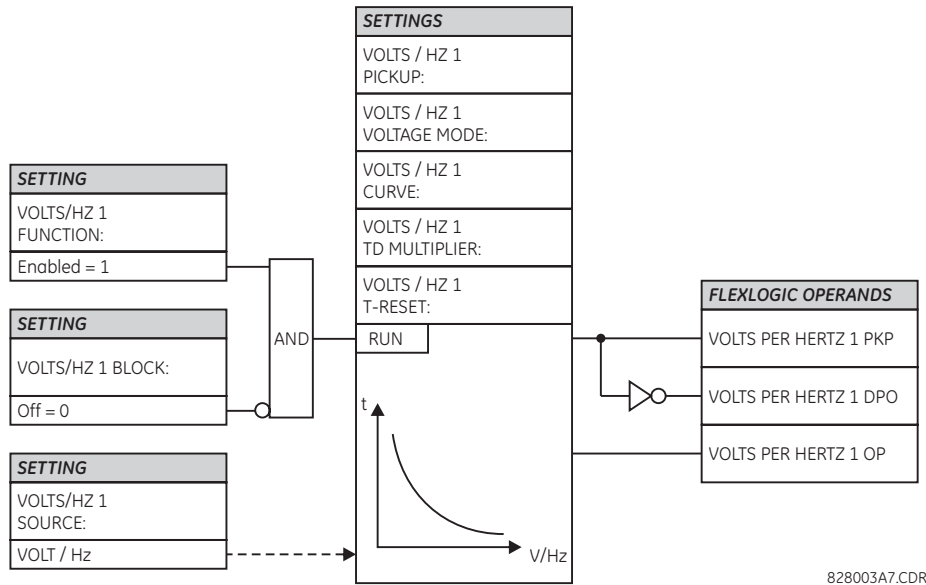
The per-unit volts-per-hertz (V/Hz) value is calculated using the maximum of the three-phase voltage inputs or the auxiliary voltage channel Vx input, if the source is not configured with phase voltages. To use the V/Hz element with auxiliary voltage, set **SYSTEM SETUP ⇒ SIGNAL SOURCES ⇒ SOURCE 1(6) ⇒ SOURCE 1(6) PHASE VT** to “None” and **SOURCE 1(6) AUX VT** to the corresponding voltage input bank. If there is no voltage on the relay terminals in either case, the per-unit V/Hz value is automatically set to “0”. The per unit value is established as per voltage and nominal frequency power system settings as follows:

1. If the phase voltage inputs defined in the source menu are used for V/Hz operation, then “1 pu” is the selected **SYSTEM SETUP ⇒ AC INPUTS ⇒ VOLTAGE BANK N ⇒ PHASE VT N SECONDARY** setting, divided by the divided by the **SYSTEM SETUP ⇒ POWER SYSTEM ⇒ NOMINAL FREQUENCY** setting.
2. If the voltage bank connection value is selected as “Delta”, then the phase-to-phase nominal voltage is used to define the per-unit value. If the voltage bank connection value is selected as “Wye”, then the **VOLTS/HZ 1 VOLTAGE MODE** setting further defines the operating quantity and per-unit value for this element. If the voltage mode is set as “Phase-phase”, then the operating quantity for this element is the phase-to-phase nominal voltage. Likewise, if the voltage

mode is set to “Phase-ground”, then the operating quantity for this element is the phase-to-ground nominal voltage. It is beneficial to use the phase-to-phase voltage mode for this element when the G30 device is applied on an isolated or resistance-grounded system.

3. When the auxiliary voltage  $V_x$  is used (regarding the condition for “None” phase voltage setting mentioned above), then the 1 pu value is the **SYSTEM SETUP ⇒ AC INPUTS ⇒ VOLTAGE BANK N ⇒ AUXILIARY VT N SECONDARY** setting divided by the **SYSTEM SETUP ⇒ POWER SYSTEM ⇒ NOMINAL FREQUENCY** setting.
4. If V/Hz source is configured with both phase and auxiliary voltages, the maximum phase among the three voltage channels at any given point in time is the input voltage signal for element operation, and therefore the per-unit value is calculated as described in Step 1. If the measured voltage of all three phase voltages is 0, than the per-unit value becomes automatically 0 regardless of the presence of auxiliary voltage.

Figure 5-136: Volts per hertz logic



The element has a linear reset characteristic. The reset time can be programmed to match the cooling characteristics of the protected equipment. The element fully resets from the trip threshold in **VOLTS/HZ T-RESET** seconds. The V/Hz element can be used as an instantaneous element with no intentional time delay or as a Definite or Inverse timed element.

The characteristics of the inverse curves are as follows.

### Definite time

For the definite time curve,  $T(\text{sec.}) = \text{TD multiplier}$ . For example, setting the TD multiplier to 20 results a time delay of 20 seconds to operate when above the Volts/Hz pickup setting. Instantaneous operation can be obtained the same way by setting the TD multiplier to “0”.

### Inverse curve A

The curve for the volts/hertz inverse curve A shape is derived from the formula:

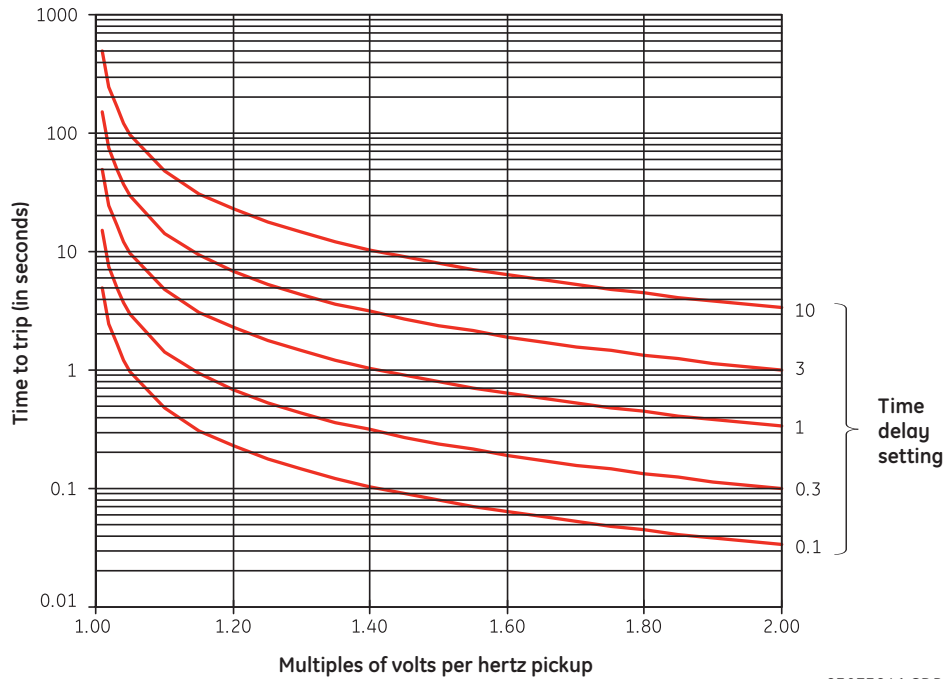
$$T = \frac{\text{TDM}}{\left[\left(\frac{V}{F}\right) / \text{Pickup}\right]^2 - 1} \text{ when } \frac{V}{F} > \text{Pickup} \tag{Eq. 5-54}$$

where

T = Operating Time  
 TDM = Time Delay Multiplier (delay in seconds)  
 V = fundamental RMS value of voltage (pu)  
 F = frequency of voltage signal (pu)  
 Pickup = volts-per-hertz pickup setpoint (pu)

The figure shows the volts/hertz inverse A curves.

Figure 5-137: Volts-per-hertz curves, inverse curve A



830738A1.CDR

**Inverse curve B**

The curve for the Volts/Hertz Inverse Curve B shape is derived from the formula:

$$T = \frac{TDM}{\left[\left(\frac{V}{F}\right) / \text{Pickup}\right] - 1} \quad \text{when } \frac{V}{F} > \text{Pickup}$$

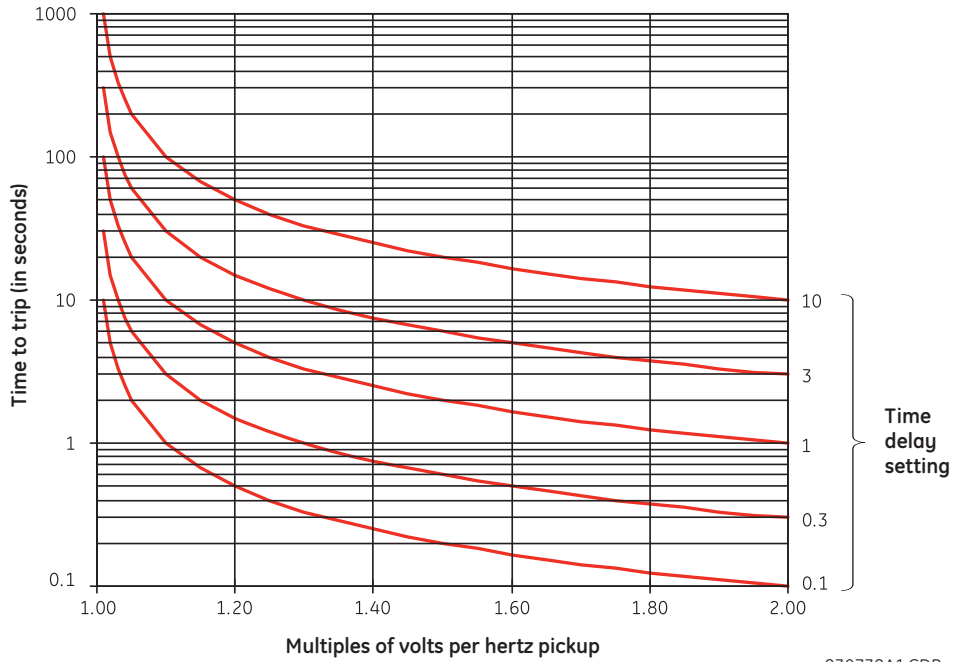
Eq. 5-55

where

T = Operating Time  
 TDM = Time Delay Multiplier (delay in sec.)  
 V = fundamental RMS value of voltage (pu)  
 F = frequency of voltage signal (pu)  
 Pickup = volts-per-hertz pickup setpoint (pu)

The figure shows the volts/hertz inverse B curves.

Figure 5-138: Volts-per-hertz curves, inverse curve B



830739A1.CDR

5

Inverse curve C

The curve for the Volts/Hertz Inverse Curve C shape is derived from the formula:

$$T = \frac{TDM}{\left[\left(\frac{V}{F}\right) / \text{Pickup}\right]^{0.5} - 1} \text{ when } \frac{V}{F} > \text{Pickup} \tag{Eq. 5-56}$$

where

T = Operating Time

TDM = Time Delay Multiplier (delay in sec.)

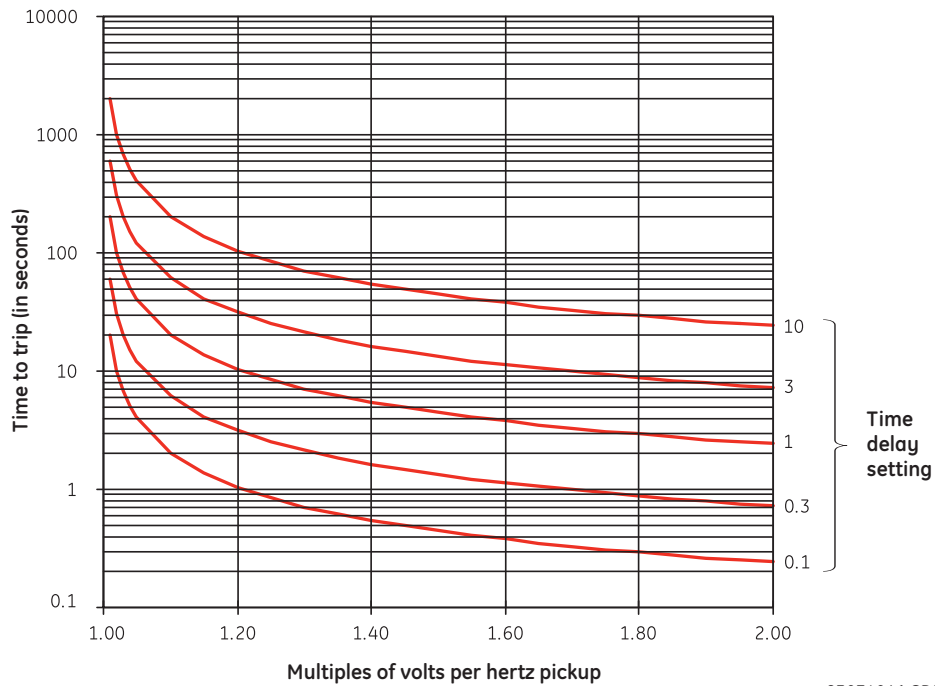
V = fundamental RMS value of voltage (pu)

F = frequency of voltage signal (pu)

Pickup = volts-per-hertz pickup setpoint (pu)

The figure shows the volts/hertz inverse C curves.

Figure 5-139: Volts-per-hertz curves, inverse curve C



830740A1.CDR

### 5.7.11 Loss of excitation (ANSI 40)

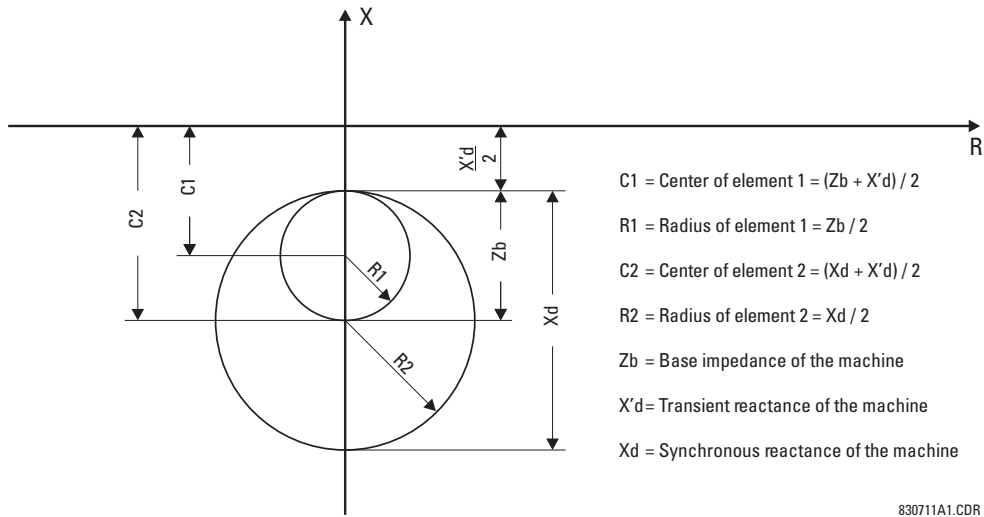
SETTINGS ⇌ GROUPED ELEMENTS ⇌ SETTING GROUP 1(6) ⇌ LOSS OF EXCITATION

<input type="checkbox"/> LOSS OF <input checked="" type="checkbox"/> EXCITATION	⇌	LOSS OF EXCITATION FUNCTION: Disabled	Range: Disabled, Enabled
	⇌	LOSS OF EXCITATION SOURCE: SRC 1	Range: SRC 1, SRC 2, SRC 3, SRC 4
	⇌	LOSS OF EXCITATION CENTER 1: 10.00 ohm	Range: 0.10 to 300.00 ohms in steps of 0.01
	⇌	LOSS OF EXCITATION RADIUS 1: 8.00 ohm	Range: 0.10 to 300.00 ohms in steps of 0.01
	⇌	EXCITATION V SUPV 1: Enabled	Range: Disabled, Enabled
	⇌	LOSS OF EXCITATION PKP DELAY1: 0.050 s	Range: 0.000 to 65.535 s in steps of 0.01
	⇌	LOSS OF EXCITATION CENTER 2: 12.00 ohm	Range: 0.10 to 300.00 ohms in steps of 0.01
	⇌	LOSS OF EXCITATION RADIUS 2: 10.00 ohm	Range: 0.10 to 300.00 ohms in steps of 0.01
	⇌	LOSS OF EXCITATION V SUPV 2: Enabled	Range: Disabled, Enabled
	⇌	LOSS OF EXCITATION PKP DELAY2: 0.500 s	Range: 0.000 to 65.535 s in steps of 0.01
	⇌	LOSS OF EXCITATION UV SUPV: 0.700 pu	Range: 0.000 to 1.250 pu in steps of 0.001

⇅	<b>LOSS OF EXCIT BLK:</b> <b>Off</b>	Range: FlexLogic operand
⇅	<b>LOSS OF EXCITATION TARGET:</b> Self-reset	Range: Self-reset, Latched, Disabled
↑	<b>LOSS OF EXCITATION EVENTS:</b> Disabled	Range: Disabled, Enabled

The operating characteristic is shaped out of two offset mho circles shifted down along the imaginary axis as shown.

**Figure 5-140: Loss of excitation operating characteristics**



830711A1.CDR

5

### Stage 1 settings

The stage 1 characteristic is typically set to detect a loss of excitation for load conditions of 30% of the nominal or higher. This is achieved with a mho element with a diameter equal to the base impedance of the machine and an offset equal to half the machine transient reactance (X'd).

$$\text{CENTER 1} = \frac{Z_b + X'd}{2}, \quad \text{RADIUS 1} = \frac{Z_b}{2} \tag{Eq. 5-57}$$

The stage 1 element should be time delayed to allow for blocking by the VT fuse failure element (50 ms).

### Stage 2 settings

The stage 2 characteristic is typically set to detect a loss of excitation for all load conditions. This is achieved with a mho element with a diameter equal to the synchronous reactance of the machine and an offset equal to half the machine transient reactance (X'd).

$$\text{CENTER 2} = \frac{X_d + X'd}{2}, \quad \text{RADIUS 1} = \frac{X_d}{2} \tag{Eq. 5-58}$$

During stable power swing conditions, the positive-sequence impedance can momentarily enter the stage 2 characteristic. For security of the function under such conditions, it is recommended to delay stage 2 by a minimum of 0.5 seconds.

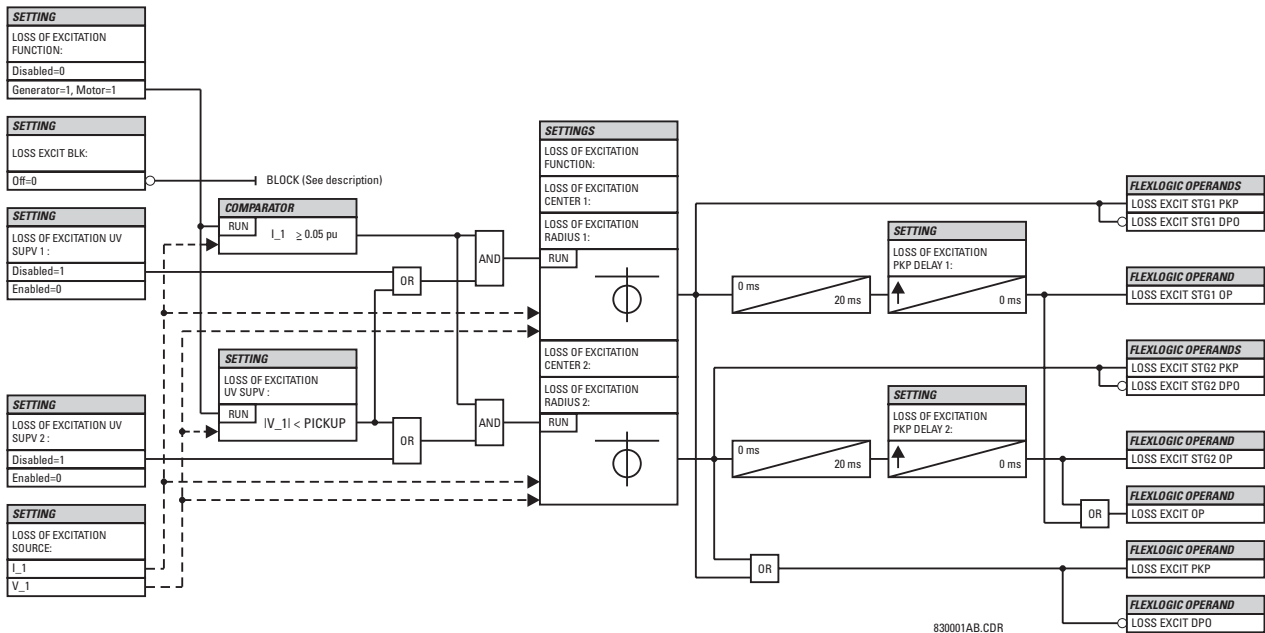
The **LOSS OF EXCIT BLK** setting specifies a FlexLogic operand for blocking the feature based on user-programmable conditions. When the blocking input is asserted, the element resets its timers, de-asserts the **PKP** and **OP** operands (if asserted), clears self-reset targets, logs a 'blocked' event if events are enabled, and becomes inactive. When unblocked, the element starts functioning instantly. If exposed to pickup conditions for an extended period of time and unblocked, the element picks up and starts timing out at the moment of unblocking.



If the VTs are located on the HV side of the transformer, then the source should be configured using CTs that are also on the HV side. Correspondingly, if the VTs are located on the LV side of the transformer, then the source should be configured using CTs that are also on the LV side. In both cases, the CT polarity should produce a positive power measurement when the machine is generating.

The element responds to the positive sequence impedance as shown in the logic diagram.

Figure 5-141: Loss of excitation logic



### 5.7.12 Accidental energization (ANSI 50/27)

SETTINGS ⇄ GROUPED ELEMENTS ⇄ SETTING GROUP 1(6) ⇄ ACCIDENTAL ENERGIZATION

■ ACCIDENTAL ■ ENERGIZATION	⇄	ACCDNT ENRG FUNCTION: Disabled	Range: Disabled, Enabled
	⇄	ACCDNT ENRG SOURCE: SRC 1	Range: SRC 1, SRC 2, SRC 3, SRC 4
	⇄	ACCDNT ENRG ARMING MODE: UV and Offline	Range: UV and Offline, UV or Offline
	⇄	ACCDNT ENRG OC PICKUP: 0.300 pu	Range: 0.020 to 3.000 pu in steps of 0.001
	⇄	ACCDNT ENRG UV PICKUP: 0.500 pu	Range: 0.004 to 3.000 pu in steps of 0.001
	⇄	ACCDNT ENRG OFFLINE: Off	Range: FlexLogic operand
	⇄	ACCDNT ENRG BLOCK: Off	Range: FlexLogic operand
	⇄	ACCDNT ENRG TARGET: Self-reset	Range: Self-reset, Latched, Disabled
	⇄	ACCDNT ENRG EVENTS: Disabled	Range: Disabled, Enabled

This element provides protection against energization while the generator is at standstill or reduced speed. The feature is armed using either the AND or OR combination of the undervoltage and machine offline conditions, selected with the **ACCDNT ENRG ARMING MODE** setting (see below). The undervoltage condition is determined from the measured voltages. The machine offline status is indicated by a dedicated FlexLogic operand. Once armed, the accidental energization feature operates upon detecting an overcurrent condition in any of the stator phases.

This feature can also provide protection against poor synchronization.

**ACCDNT ENRG ARMING MODE** — This setting specifies whether the feature gets armed by either of the undervoltage or machine offline conditions (“UV or Offline” value), or by both the conditions (“UV and Offline” value). In both cases, the element is armed after five seconds of the appropriate condition and de-armed 250 ms after the arming condition (UV and/or Offline) ceases.

Select “UV or Offline” when the VTs are on the power system side of the disconnecting device. If this is the case, the measured voltages can be normal regardless of the status of the protected machine, thus the need for an OR condition. The “UV or Offline” value provides protection against poor synchronization. During normal synchronization, there should be relatively low current measured. If however, synchronization is attempted when conditions are not appropriate, a large current is measured shortly after closing the breaker. Since this feature does not de-arm immediately, but after a 250 ms time delay, this results in operation under imprecise synchronization. The **ACCDNT ENRG OC PICKUP** setting can control the required precision of synchronization.

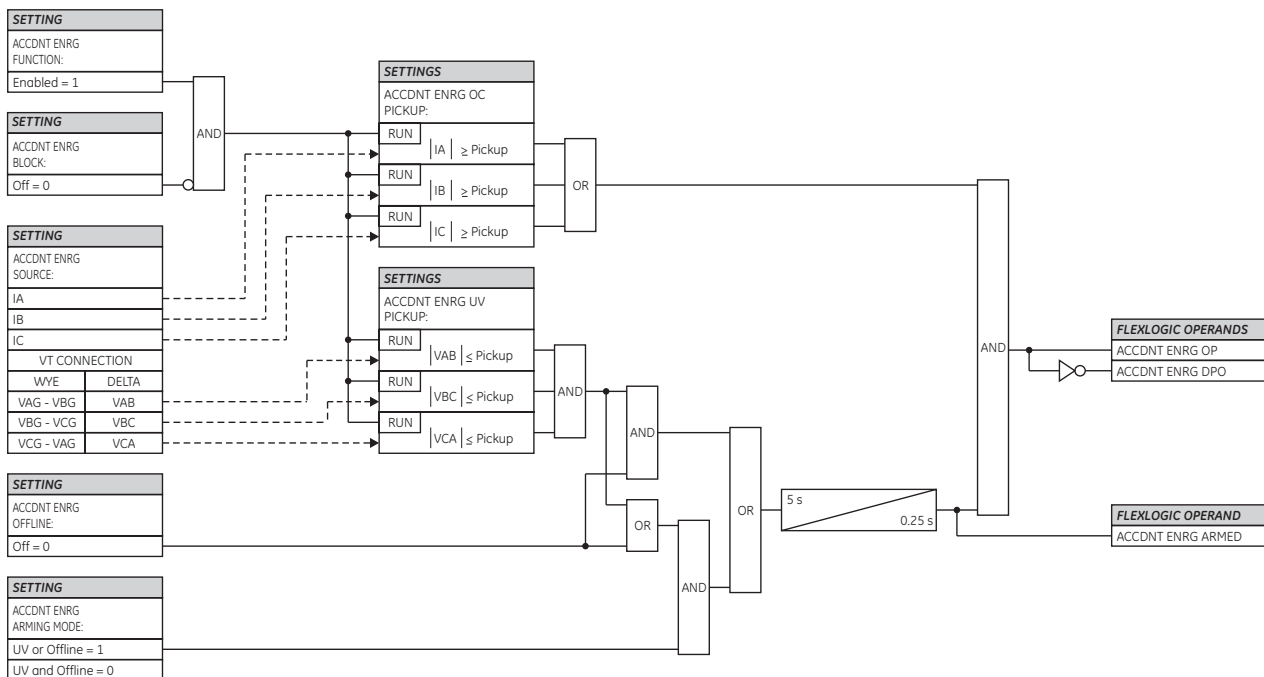
Select the “UV and Offline” value when the VTs are on the generator side of the disconnecting device. If this is the case, both the undervoltage and machine offline conditions are required to indicate that the protected generator is not energized.

**ACCDNT ENRG OC PICKUP** — This setting specifies the current level required to operate the armed Accidental Energization element. If any of the phase current is above the **ACCDNT ENRG OC PICKUP** level, the feature operates.

**ACCDNT ENRG UV PICKUP** — This setting specifies the voltage level required to arm the Accidental Energization element. All of the line-to-line voltages must drop below the **ACCDNT ENRG UV PICKUP** level in order to detect the undervoltage condition. The setting is entered in voltage pu values. As the element always responds to the line-to-line voltages, care must be applied in picking up the value depending on the VT connection.

**ACCDNT ENRG OFFLINE** — This setting specifies the FlexLogic operand indicating that the protected generator is offline.

Figure 5-142: Accidental energization logic



830004A5.CDR



### 5.7.13 Sensitive directional power (ANSI 32)

SETTINGS ⇒ GROUPED ELEMENTS ⇒ SETTING GROUP 1(6) ⇒ POWER ⇒ SENSITIVE DIRECTIONAL POWER ⇒ DIRECTIONAL POWER 1(2)

<ul style="list-style-type: none"> <li>■ DIRECTIONAL</li> <li>■ POWER 1</li> </ul>	↔	DIR POWER 1 FUNCTION: Disabled	Range: Disabled, Enabled
	⇅	DIR POWER 1 SOURCE: SRC 1	Range: SRC 1, SRC 2, SRC 3, SRC 4
	⇅	DIR POWER 1 RCA: 0°	Range: 0 to 359° in steps of 1
	⇅	DIR POWER 1 CALIBRATION: 0.00°	Range: 0 to 0.95° in steps of 0.05
	⇅	DIR POWER 1 STG1 SMIN: 0.100 pu	Range: -1.200 to 1.200 pu in steps of 0.001
	⇅	DIR POWER 1 STG1 DELAY: 0.50 s	Range: 0.00 to 600.00 s in steps of 0.01
	⇅	DIR POWER 1 STG2 SMIN: 0.100 pu	Range: -1.200 to 1.200 pu in steps of 0.001
	⇅	DIR POWER 1 STG2 DELAY: 20.00 s	Range: 0.00 to 600.00 s in steps of 0.01
	⇅	DIR POWER 1 BLK: Off	Range: FlexLogic operand
	⇅	DIR POWER 1 TARGET: Self-reset	Range: Self-reset, Latched, Disabled
	↑	DIR POWER 1 EVENTS: Disabled	Range: Disabled, Enabled

The sensitive directional power element responds to three-phase directional power and is designed for reverse power and low forward power applications for synchronous machines or interconnections involving co-generation. The relay measures the three-phase power from either a full set of wye-connected VTs or a full set of delta-connected VTs. In the latter case, the two-wattmeter method is used. See the UR-series Metering Conventions section in chapter 6 for details regarding the active and reactive powers used by the sensitive directional power element.

The element has an adjustable characteristic angle and minimum operating power as shown in the Directional Power Characteristic diagram that follows. The element responds to the following condition:

$$P \cos \theta + Q \sin \theta > \text{SMIN} \quad \text{Eq. 5-59}$$

where

P and Q are active and reactive powers as measured per the UR metering convention

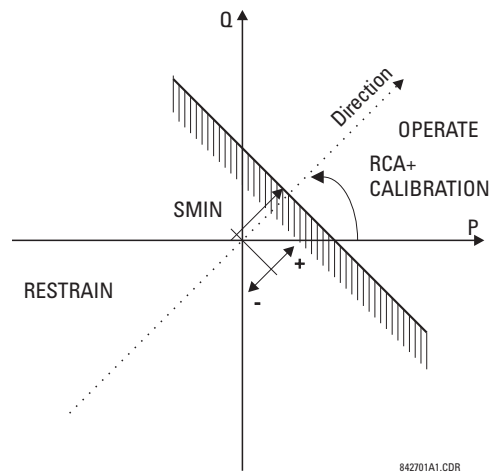
θ is a sum of the element characteristic (DIR POWER 1 RCA) and calibration (DIR POWER 1 CALIBRATION) angles

SMIN is the minimum operating power

The operating quantity is displayed in the ACTUAL VALUES ⇒ METERING ⇒ SENSITIVE DIRECTIONAL POWER 1(2) actual value.

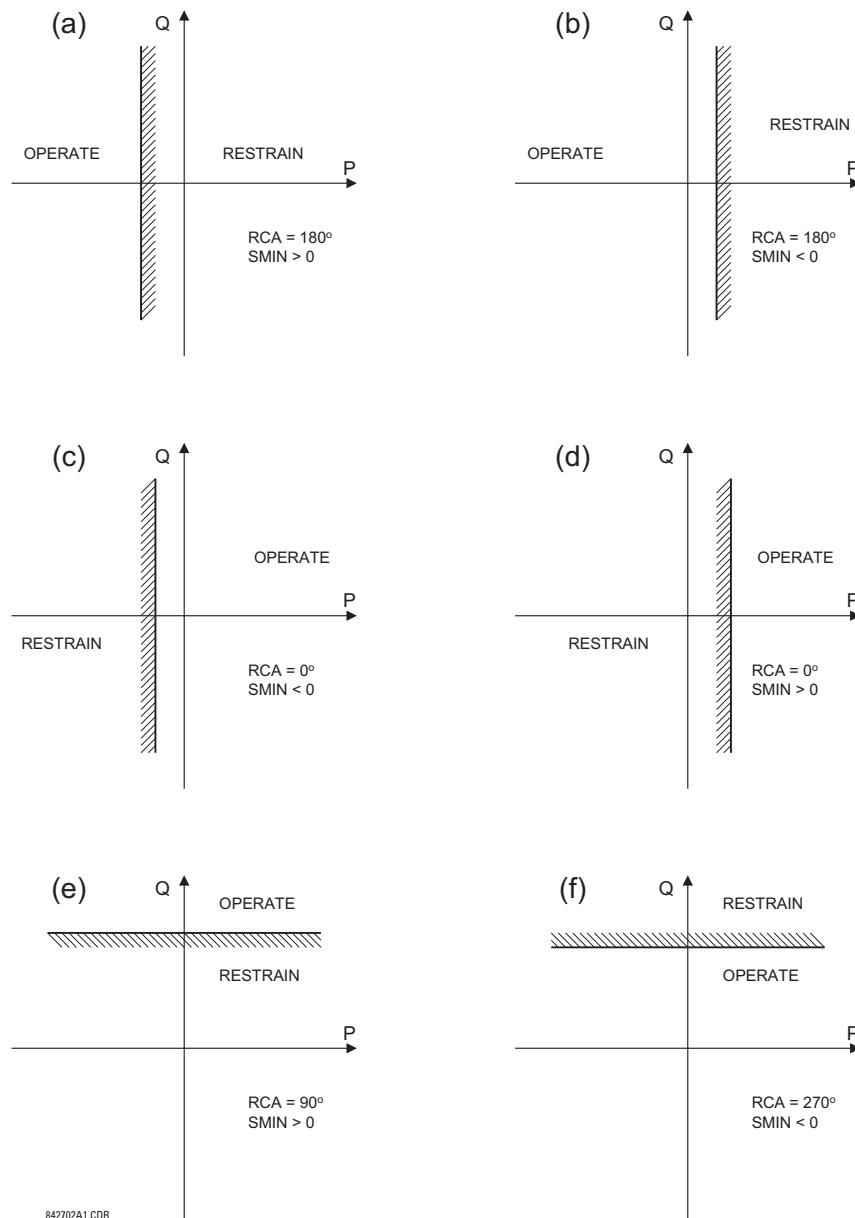
The element has two independent (as to the pickup and delay settings) stages for alarm and trip, respectively.

Figure 5-143: Directional power characteristic



By making the characteristic angle adjustable and providing for both negative and positive values of the minimum operating power, a variety of operating characteristics can be achieved as presented in the following figure. For example, section (a) in the figure shows settings for reverse power, while section (b) shows settings for low forward power applications.

Figure 5-144: Directional power element sample applications



**DIR POWER 1 RCA** — Specifies the relay characteristic angle (RCA) for the sensitive directional power function. Application of this setting is threefold:

- It allows the element to respond to active or reactive power in any direction (active overpower/underpower, and so on)
- Together with a precise calibration angle, it allows compensation for any CT and VT angular errors to permit more sensitive settings
- It allows for required direction in situations when the voltage signal is taken from behind a delta-wye connected power transformer and the phase angle compensation is required

For example, the active overpower characteristic is achieved by setting **DIR POWER 1 RCA** to "0°," reactive overpower by setting **DIR POWER 1 RCA** to "90°," active underpower by setting **DIR POWER 1 RCA** to "180°," and reactive underpower by setting **DIR POWER 1 RCA** to "270°."

**DIR POWER 1 CALIBRATION** — This setting allows the relay characteristic angle to change in steps of 0.05°. This is useful when a small difference in VT and CT angular errors is to be compensated to permit more sensitive settings. This setting virtually enables calibration of the directional power function in terms of the angular error of applied VTs and CTs. The element responds to the sum of the **DIR POWER 1 RCA** and **DIR POWER 1 CALIBRATION** settings.

**DIR POWER 1 STG1 SMIN** — This setting specifies the minimum power as defined along the relay characteristic angle (RCA) for the stage 1 of the element. The positive values imply a shift towards the operate region along the RCA line; the negative values imply a shift towards the restrain region along the RCA line. See the Directional Power Sample Applications figure for details. Together with the RCA, this setting enables a wide range of operating characteristics. This setting applies to three-phase power and is entered in per-unit (pu) values. The base quantity is  $3 \times VT \text{ pu base} \times CT \text{ pu base}$ .

For example, a setting of 2% for a 200 MW machine is  $0.02 \times 200 \text{ MW} = 4 \text{ MW}$ . If 13.8kV is line voltage and 10 kA is a primary CT current, the source pu quantity is 239 MVA, and thus, SMIN needs to be set at  $4 \text{ MW} / 239 \text{ MVA} = 0.0167 \text{ pu} \approx 0.017 \text{ pu}$ . If the reverse power application is considered,  $RCA = 180^\circ$  and  $SMIN = 0.017 \text{ pu}$ .

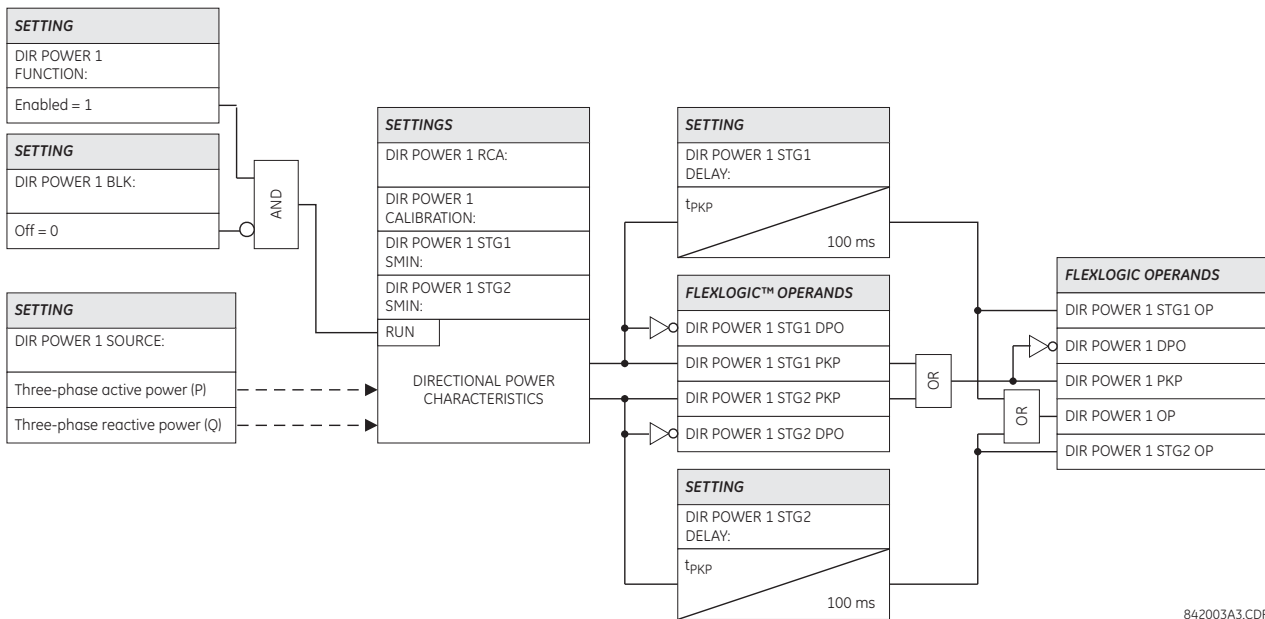
The element drops out if the magnitude of the positive-sequence current becomes virtually zero, that is, it drops below the cutoff level.

**DIR POWER 1 STG1 DELAY** — This setting specifies a time delay for stage 1. For reverse power or low forward power applications for a synchronous machine, stage 1 is typically applied for alarming and stage 2 for tripping.



If the VTs are located on the high-voltage (HV) side of the transformer, then the source should be configured using CTs that are also on the HV side. Correspondingly, if the VTs are located on the low-voltage (LV) side of the transformer, then the source should be configured using CTs that are also on the LV side. In both cases, the CT polarity should produce a positive power measurement when the machine is generating.

Figure 5-145: Sensitive directional power logic



842003A3.CDR

## 5.7.14 Stator ground

### 5.7.14.1 Menu

SETTINGS ⇄ GROUPED ELEMENTS ⇄ SETTING GROUP 1(6) ⇄ STATOR GROUND

■ STATOR
■ GROUND



STATOR GROUND SOURCE: SRC1
----------------------------

Range: SRC 1, SRC 2, SRC 3, SRC 4



■ 3RD HARM NTRL
■ UNDERVOLTAGE

See below

Third harmonic neutral undervoltage protection that responds to the third harmonic in the voltage at the machine neutral point is provided as a means of stator ground protection.

This element is configured through its individual setting menu. The **STATOR GROUND SOURCE** setting specifies a signal source used to provide current and voltage signals for stator ground fault protection. The third harmonic neutral undervoltage function is configured as follows:

- Configure phase voltages measured at the terminal of the machine as phase VT banks. The element uses the voltages to measure the power at the machine terminals for power supervision.
- Configure phase currents measured at the terminal of the machine as phase CT banks. The element uses the currents to measure the power at the machine terminals for power supervision.
- Configure voltage measured at the neutral of the machine as the auxiliary VT bank. The element extracts the third harmonic of the auxiliary voltage from the source in order to operate.

### 5.7.14.2 Third harmonic neutral undervoltage (ANSI 27TN)

SETTINGS ⇌ GROUPED ELEMENTS ⇌ SETTING GROUP 1(6) ⇌ STATOR GROUND ⇌ 3RD HARM NTRL UNDERVOLTAGE

<div style="border: 1px solid black; padding: 2px;">           ■ 3RD HARM NTRL            ■ UNDERVOLTAGE         </div>	↔	<div style="border: 1px solid black; padding: 2px;">           3RD HARM NTRL UV            FUNCTION: Disabled         </div>	Range: Disabled, Enabled
	↕	<div style="border: 1px solid black; padding: 2px;">           3RD HARM NTRL UV            PICKUP: 0.3000 pu         </div>	Range: 0.0010 to 3.0000 pu in steps of 0.0001
	↕	<div style="border: 1px solid black; padding: 2px;">           3RD HARM NTRL UV PKP            DELAY: 0.00 s         </div>	Range: 0.00 to 600.00 s in steps of 0.01
	↕	<div style="border: 1px solid black; padding: 2px;">           3RD HARM NTRL UV MAX            POWER: 0.200 pu         </div>	Range: 0.000 to 1.250 pu in steps of 0.001
	↕	<div style="border: 1px solid black; padding: 2px;">           3RD HARM NTRL UV MIN            POWER: 0.200 pu         </div>	Range: 0.000 to 1.250 pu in steps of 0.001
	↕	<div style="border: 1px solid black; padding: 2px;">           3RD HARM NTRL UV            VOLT SUPV: 0.500 pu         </div>	Range: 0.000 to 1.250 pu in steps of 0.001
	↕	<div style="border: 1px solid black; padding: 2px;">           3RD HARM NTRL UV BLK:            Off         </div>	Range: FlexLogic operand
	↕	<div style="border: 1px solid black; padding: 2px;">           3RD HARM NTRL UV            TARGET: Self-reset         </div>	Range: Self-reset, Latched, Disabled
	↑	<div style="border: 1px solid black; padding: 2px;">           3RD HARM NTRL UV            EVENTS: Disabled         </div>	Range: Disabled, Enabled

The third harmonic neutral undervoltage function detects a loss of third harmonic voltage at the generator neutral. The percentage of stator winding covered by this function depends on the pickup setting and the amount of third harmonic generated by the machine at the time of the fault. A settable window of forward power can supervise this element for enhanced security. The element is also supervised by positive-sequence voltage measured at the generator output terminals. This element can be used with either wye or delta connected VTs on the terminal side and requires the machine neutral voltage to be connected via an auxiliary voltage channel of a relay VT bank.

**3RD HARM NTRL UV PICKUP** — This setting specifies the pickup level for the magnitude of the third harmonic of the neutral voltage. This setting is entered in pu of the nominal auxiliary voltage. Use the **ACTUAL VALUES ⇌ METERING ⇌ STATOR GROUND** menu to monitor the magnitude of the third harmonic voltage at the neutral point. Measuring the actual value of the operating quantity for a specific machine under variety of load conditions can be helpful when selecting the pickup threshold for this feature.

**3RD HARM NTRL UV MAX POWER** — This setting specifies the maximum active power that inhibits this protection function. If the measured power is below this setting but above the **3RD HARM NTRL UV MIN POWER** setting, the element does not operate. This setting applies to three-phase power and is entered in pu. The base quantity is three-phase power on the primary side, which is calculated as  $\sqrt{3} \times \text{Phase CT Primary} \times \text{Phase VT Ratio} \times \text{Phase VT Secondary}$  in case of delta connected VTs and as  $3 \times \text{Phase CT Primary} \times \text{Phase VT Ratio} \times \text{Phase VT Secondary}$  in case of wye connected VTs.

For example, a setting of 20% for a 200 MW machine, is  $0.20 \times 200 \text{ MW} = 40 \text{ MW}$ . If 7.967 kV is a primary VT voltage and 10 kA is a primary CT current, the source pu quantity is 239 MVA, and thus, the pu power setting is  $40 \text{ MW} / 239 \text{ MVA} = 0.167 \text{ pu}$ .

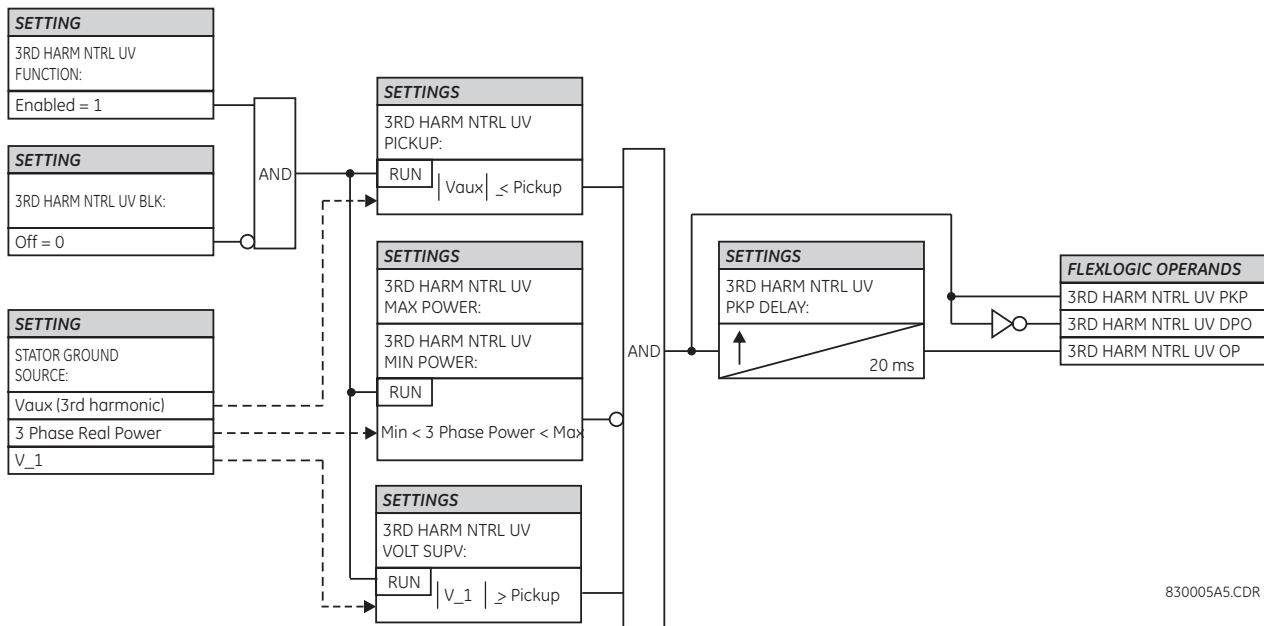
**3RD HARM NTRL UV MIN POWER** — This setting specifies the minimum active power that inhibits this protection function. If the measured power is above this setting but below the **3RD HARM NTRL UV MAX POWER** setting, the element does not operate. If the **3RD HARMONIC NTRL UV MIN POWER** is set to “0.00 pu”, then the element does not operate for all power values less than the **3RD HARM NTRL UV MAX POWER** setting.

This setting applies to three-phase power and is entered in pu. The base quantity is three-phase power on the primary side, which is calculated as  $\sqrt{3} \times \text{Phase CT Primary} \times \text{Phase VT Ratio} \times \text{Phase VT Secondary}$  in case of delta connected VTs and as  $3 \times \text{Phase CT Primary} \times \text{Phase VT Ratio} \times \text{Phase VT Secondary}$  in case of wye connected VTs.



If the VTs are located on the high-voltage (HV) side of the transformer, then configure the source using CTs that are also on the HV side. Correspondingly, if the VTs are located on the low-voltage (LV) side of the transformer, then configure the source using CTs that are also on the LV side. In both cases, the CT polarity produces a positive power measurement when the machine is generating.

Figure 5-146: Third harmonic neutral undervoltage logic



830005A5.CDR

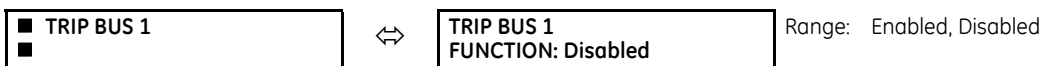
## 5.8 Control elements

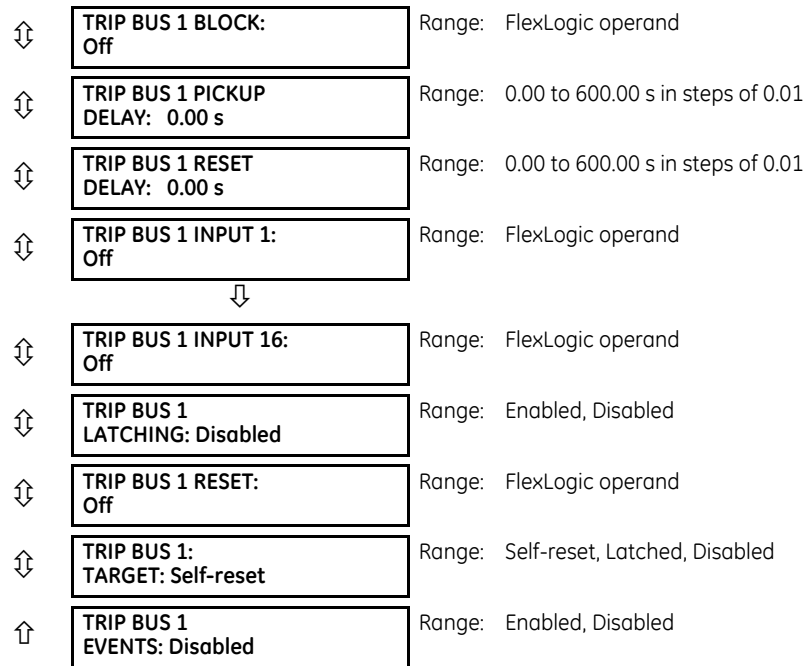
### 5.8.1 Overview

Control elements are used for control rather than protection. See the Introduction to Elements section at the beginning of this chapter for information.

### 5.8.2 Trip bus

SETTINGS ⇄ CONTROL ELEMENTS ⇄ TRIP BUS ⇄ TRIP BUS 1(6)





The trip bus element allows aggregating outputs of protection and control elements without using FlexLogic and assigning them a simple and effective manner. Each trip bus can be assigned for either trip or alarm actions. Simple trip conditioning such as latch, delay, and seal-in delay are available.

The easiest way to assign element outputs to a trip bus is through the EnerVista software under **Settings > Protection Summary**. Navigate to a specific protection or control protection element and check the bus box by hovering over the blank check box and selecting an option that displays. Once the required element is selected for a specific bus, a list of element operate-type operands are displayed and can be assigned to a trip bus. If more than one operate-type operand is required, it can be assigned directly from the trip bus menu.

Figure 5-147: Trip bus fields in the protection summary

GROUPED ELEMENTS	TB1	TB2	TB3	TB4	TB5	GROUP 1	GROUP 2	GROUP 3	GROUP 4	GROUP 5	GROUP 6
Current Differential	<input type="checkbox"/>	<input type="checkbox"/>	<input type="checkbox"/>	<input type="checkbox"/>	<input type="checkbox"/>	Disabled	Disabled	Disabled	Disabled	Disabled	Disabled
Stub Bus	<input type="checkbox"/>	<input type="checkbox"/>	<input type="checkbox"/>	<input type="checkbox"/>	<input type="checkbox"/>	Disabled	Disabled	Disabled	Disabled	Disabled	Disabled
Line Pickup	<input type="checkbox"/>	<input type="checkbox"/>	<input type="checkbox"/>	<input type="checkbox"/>	<input type="checkbox"/>	Disabled	Disabled	Disabled	Disabled	Disabled	Disabled
Phase Distance Z 1	<input type="checkbox"/>	<input type="checkbox"/>	<input type="checkbox"/>	<input type="checkbox"/>	<input type="checkbox"/>	Disabled	Disabled	Disabled	Disabled	Disabled	Disabled
Phase Distance Z 2	<input type="checkbox"/>	<input type="checkbox"/>	<input type="checkbox"/>	<input type="checkbox"/>	<input type="checkbox"/>	Disabled	Disabled	Disabled	Disabled	Disabled	Disabled
Phase Distance Z 3	<input type="checkbox"/>	<input type="checkbox"/>	<input type="checkbox"/>	<input type="checkbox"/>	<input type="checkbox"/>	Disabled	Disabled	Disabled	Disabled	Disabled	Disabled
Ground Distance Z 1	<input type="checkbox"/>	<input type="checkbox"/>	<input type="checkbox"/>	<input type="checkbox"/>	<input type="checkbox"/>	Disabled	Disabled	Disabled	Disabled	Disabled	Disabled
Ground Distance Z 2	<input type="checkbox"/>	<input type="checkbox"/>	<input type="checkbox"/>	<input type="checkbox"/>	<input type="checkbox"/>	Disabled	Disabled	Disabled	Disabled	Disabled	Disabled
Ground Distance Z 3	<input type="checkbox"/>	<input type="checkbox"/>	<input type="checkbox"/>	<input type="checkbox"/>	<input type="checkbox"/>	Disabled	Disabled	Disabled	Disabled	Disabled	Disabled
Power Swing	<input type="checkbox"/>	<input type="checkbox"/>	<input type="checkbox"/>	<input type="checkbox"/>	<input type="checkbox"/>	Disabled	Disabled	Disabled	Disabled	Disabled	Disabled
Load Encroachment	<input type="checkbox"/>	<input type="checkbox"/>	<input type="checkbox"/>	<input type="checkbox"/>	<input type="checkbox"/>	Disabled	Disabled	Disabled	Disabled	Disabled	Disabled
Phase TOC 1	<input type="checkbox"/>	<input type="checkbox"/>	<input type="checkbox"/>	<input type="checkbox"/>	<input type="checkbox"/>	Disabled	Disabled	Disabled	Disabled	Disabled	Disabled
Phase TOC 2	<input type="checkbox"/>	<input type="checkbox"/>	<input type="checkbox"/>	<input type="checkbox"/>	<input type="checkbox"/>	Disabled	Disabled	Disabled	Disabled	Disabled	Disabled
Phase TOC 3	<input type="checkbox"/>	<input type="checkbox"/>	<input type="checkbox"/>	<input type="checkbox"/>	<input type="checkbox"/>	Disabled	Disabled	Disabled	Disabled	Disabled	Disabled
Phase TOC 4	<input type="checkbox"/>	<input type="checkbox"/>	<input type="checkbox"/>	<input type="checkbox"/>	<input type="checkbox"/>	Disabled	Disabled	Disabled	Disabled	Disabled	Disabled

The following settings are available.

**TRIP BUS 1 BLOCK** — The trip bus output is blocked when the operand assigned to this setting is asserted.

**TRIP BUS 1 PICKUP DELAY** — This setting specifies a time delay to produce an output depending on how output is used.

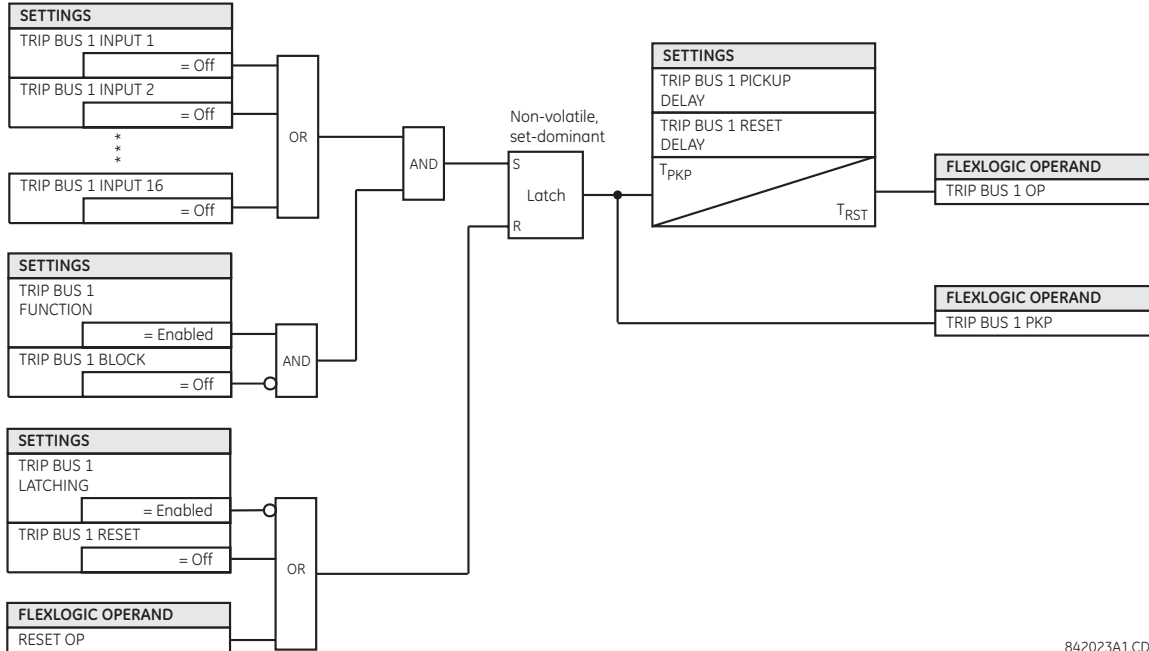
**TRIP BUS 1 RESET DELAY** — This setting specifies a time delay to reset an output command. Set the time delay long enough to allow the breaker or contactor to perform a required action.

**TRIP BUS 1 INPUT 1 to TRIP BUS 1 INPUT 16** — These settings select a FlexLogic operand to be assigned as an input to the trip bus.

**TRIP BUS 1 LATCHING** — This setting enables or disables latching of the trip bus output. This is typically used when lockout is required or user acknowledgement of the relay response is required.

**TRIP BUS 1 RESET** — The trip bus output is reset when the operand assigned to this setting is asserted. Note that the **RESET OP** operand is pre-wired to the reset gate of the latch. As such, a reset command from the front panel interface or via communications resets the trip bus output.

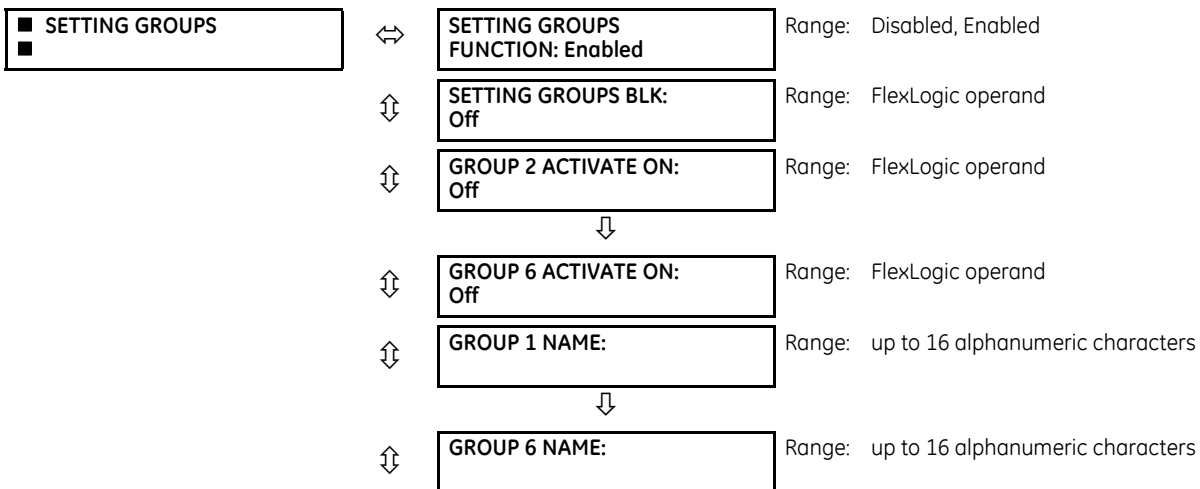
Figure 5-148: Trip bus logic



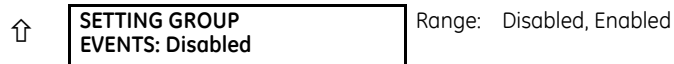
842023A1.CDR

### 5.8.3 Setting groups

SETTINGS ⇄ CONTROL ELEMENTS ⇄ SETTING GROUPS







The setting groups menu controls the activation and deactivation of up to six possible groups of settings in the **GROUPED ELEMENTS** settings menu. The active setting group can be indicated on the front display of the UR by configuring User-Programmable LEDs to display the state of the **SETTING GROUP ACT** FlexLogic operands.

**SETTING GROUPS FUNCTION** — When Enabled, allows setting groups other than group 1 (the default active group) to be activated. The default setting group is forced active while the **SETTING GROUPS FUNCTION** setting is Disabled.

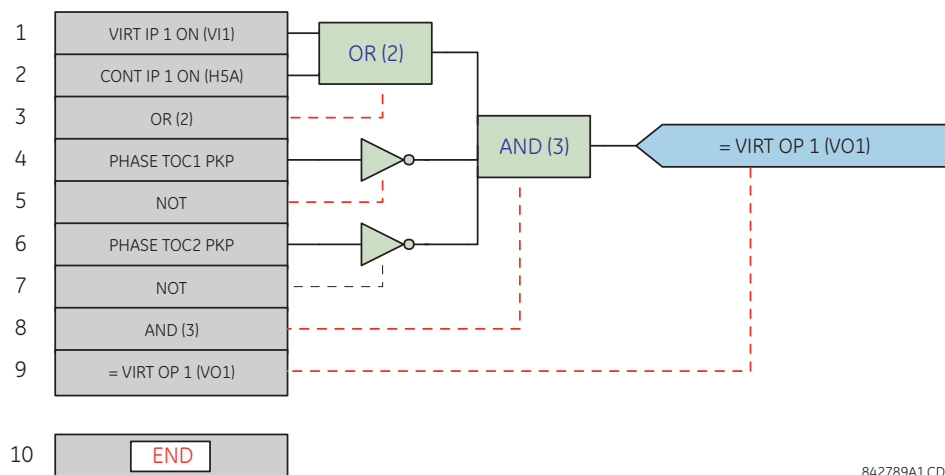
**SETTING GROUPS BLK** — Prevents the active setting group from changing when the selected FlexLogic operand is "On." This can be useful in applications where it is undesirable to change the settings under certain conditions, such as during a control sequence.

**GROUP 2 ACTIVATE ON to GROUP 6 ACTIVATE ON** — Selects a FlexLogic operand which, when set, makes the particular setting group active for use by any grouped element. A priority scheme ensures that only one group is active at a given time — the highest-numbered group that is activated by its **ACTIVATE ON** parameter takes priority over the lower-numbered groups. There is no activate on setting for group 1 (the default active group), because group 1 automatically becomes active if no other group is active.

**SETTING GROUP 1 NAME to SETTING GROUP 6 NAME** — Allows the user to assign a name to each of the six settings groups. Once programmed, this name appears on the second line of the **GROUPED ELEMENTS ⇒ SETTING GROUP 1(6)** menu display.

The relay can be set up via a FlexLogic equation to receive requests to activate or de-activate a particular non-default settings group. The following FlexLogic equation (see the following figure) illustrates requests via remote communications (for example, **VIRTUAL INPUT 1 ON**) or from a local contact input (for example, **CONTACT IP 1 ON**) to initiate the use of a particular settings group, and requests from several overcurrent pickup measuring elements to inhibit the use of the particular settings group. The assigned **VIRTUAL OUTPUT 1** operand is used to control the "On" state of a particular settings group.

Figure 5-149: Example of FlexLogic control of a setting group



842789A1.CDR

A setting group selection can also be made by the IEC 61850 MMS service SelectActiveSG to the control block @Master/LLN0.SGCB. The priority scheme mentioned makes active the highest numbered group selected by SelectActiveSG or the **GROUP ACTIVATE ON** settings. The SelectActiveSG selection has a default value of 1, so until a higher SelectActiveSG selection is received, the **GROUP ACTIVATE ON** settings control the active group.

The most recent SelectActiveSG selection is preserved while the UR is powered down or reset.

If it becomes necessary to cancel the SelectActiveSG selection without using a SelectActiveSG service request, change the **SETTING GROUPS FUNCTION** setting to Disabled. This resets the SelectActiveSG selection to 1.

## 5.8.4 Selector switch

SETTINGS ⇒ CONTROL ELEMENTS ⇒ SELECTOR SWITCH ⇒ SELECTOR SWITCH 1(2)

<div style="border: 1px solid black; padding: 2px;"> <p>■ SELECTOR SWITCH 1</p> <p>■</p> </div>	↔	<div style="border: 1px solid black; padding: 2px;"> <p>SELECTOR 1 FUNCTION: Disabled</p> </div>	Range: Disabled, Enabled
	↕	<div style="border: 1px solid black; padding: 2px;"> <p>SELECTOR 1 FULL RANGE: 7</p> </div>	Range: 1 to 7 in steps of 1
	↕	<div style="border: 1px solid black; padding: 2px;"> <p>SELECTOR 1 TIME-OUT: 5.0 s</p> </div>	Range: 3.0 to 60.0 s in steps of 0.1
	↕	<div style="border: 1px solid black; padding: 2px;"> <p>SELECTOR 1 STEP-UP: Off</p> </div>	Range: FlexLogic operand
	↕	<div style="border: 1px solid black; padding: 2px;"> <p>SELECTOR 1 STEP-UP MODE: Time-out</p> </div>	Range: Time-out, Acknowledge
	↕	<div style="border: 1px solid black; padding: 2px;"> <p>SELECTOR 1 ACK: Off</p> </div>	Range: FlexLogic operand
	↕	<div style="border: 1px solid black; padding: 2px;"> <p>SELECTOR 1 3BIT A0: Off</p> </div>	Range: FlexLogic operand
	↕	<div style="border: 1px solid black; padding: 2px;"> <p>SELECTOR 1 3BIT A1: Off</p> </div>	Range: FlexLogic operand
	↕	<div style="border: 1px solid black; padding: 2px;"> <p>SELECTOR 1 3BIT A2: Off</p> </div>	Range: FlexLogic operand
	↕	<div style="border: 1px solid black; padding: 2px;"> <p>SELECTOR 1 3BIT MODE: Time-out</p> </div>	Range: Time-out, Acknowledge
	↕	<div style="border: 1px solid black; padding: 2px;"> <p>SELECTOR 1 3BIT ACK: Off</p> </div>	Range: FlexLogic operand
	↕	<div style="border: 1px solid black; padding: 2px;"> <p>SELECTOR 1 POWER-UP MODE: Restore</p> </div>	Range: Restore, Synchronize, Sync/Restore
	↕	<div style="border: 1px solid black; padding: 2px;"> <p>SELECTOR 1 TARGETS: Self-reset</p> </div>	Range: Self-reset, Latched, Disabled
	↑	<div style="border: 1px solid black; padding: 2px;"> <p>SELECTOR 1 EVENTS: Disabled</p> </div>	Range: Disabled, Enabled

The selector switch element is intended to replace a mechanical selector switch. Typical applications include setting group control or control of multiple logic sub-circuits in user-programmable logic.

The element provides for two control inputs. The step-up control allows stepping through selector position one step at a time with each pulse of the control input, such as a user-programmable pushbutton. The three-bit control input allows setting the selector to the position defined by a three-bit word.

The element allows pre-selecting a new position without applying it. The pre-selected position gets applied either after time-out or upon acknowledgement via separate inputs (user setting). The selector position is stored in non-volatile memory. Upon power-up, either the previous position is restored or the relay synchronizes to the current three-bit word (user setting). Basic alarm functionality alerts the user under abnormal conditions; for example, the three-bit control input being out of range.

A selector switch runs every two power cycles.

**SELECTOR 1 FULL RANGE** — This setting defines the upper position of the selector. When stepping up through available positions of the selector, the upper position wraps up to the lower position (position 1). When using a direct three-bit control word for programming the selector to a desired position, the change would take place only if the control word is within the range of 1 to the **SELECTOR FULL RANGE**. If the control word is outside the range, an alarm is established by setting the **SELECTOR ALARM** FlexLogic operand for three seconds.

**SELECTOR 1 TIME-OUT** — This setting defines the time-out period for the selector. This value is used by the relay in the following two ways. When the **SELECTOR STEP-UP MODE** is “Time-out,” the setting specifies the required period of inactivity of the control input after which the pre-selected position is automatically applied. When the **SELECTOR STEP-UP MODE** is “Acknowledge,” the setting specifies the period of time for the acknowledging input to appear. The timer is re-started by any activity of the control input. The acknowledging input must come before the **SELECTOR 1 TIME-OUT** timer expires; otherwise, the change does not take place and an alarm is set.

**SELECTOR 1 STEP-UP** — This setting specifies a control input for the selector switch. The switch is shifted to a new position at each rising edge of this signal. The position changes incrementally, wrapping up from the last (**SELECTOR 1 FULL RANGE**) to the first (position 1). Consecutive pulses of this control operand must not occur faster than every 50 ms. After each rising edge of the assigned operand, the time-out timer is restarted and the **SELECTOR SWITCH 1: POS Z CHNG INITIATED** target message is displayed, where Z the pre-selected position. The message is displayed for the time specified by the **FLASH MESSAGE TIME** setting. The pre-selected position is applied after the selector times out (“Time-out” mode), or when the acknowledging signal appears before the element times out (“Acknowledge” mode). When the new position is applied, the relay displays the **SELECTOR SWITCH 1: POSITION Z IN USE** message. Typically, a user-programmable pushbutton is configured as the stepping up control input.

**SELECTOR 1 STEP-UP MODE** — This setting defines the selector mode of operation. When set to “Time-out,” the selector changes its position after a pre-defined period of inactivity at the control input. The change is automatic and does not require any explicit confirmation of the intent to change the selector’s position. When set to “Acknowledge,” the selector changes its position only after the intent is confirmed through a separate acknowledging signal. If the acknowledging signal does not appear within a pre-defined period of time, the selector does not accept the change and an alarm is established by setting the **SELECTOR STP ALARM** output FlexLogic operand for three seconds.

**SELECTOR 1 ACK** — This setting specifies an acknowledging input for the stepping up control input. The pre-selected position is applied on the rising edge of the assigned operand. This setting is active only under “Acknowledge” mode of operation. The acknowledging signal must appear within the time defined by the **SELECTOR 1 TIME-OUT** setting after the last activity of the control input. A user-programmable pushbutton is typically configured as the acknowledging input.

**SELECTOR 1 3BIT A0, A1, and A2** — These settings specify a three-bit control input of the selector. The three-bit control word pre-selects the position using the following encoding convention:

A2	A1	A0	Position
0	0	0	rest
0	0	1	1
0	1	0	2
0	1	1	3
1	0	0	4
1	0	1	5
1	1	0	6
1	1	1	7

The “rest” position (0, 0, 0) does not generate an action and is intended for situations when the device generating the three-bit control word is having a problem. When **SELECTOR 1 3BIT MODE** is “Time-out,” the pre-selected position is applied in **SELECTOR 1 TIME-OUT** seconds after the last activity of the three-bit input. When **SELECTOR 1 3BIT MODE** is “Acknowledge,” the pre-selected position is applied on the rising edge of the **SELECTOR 1 3BIT ACK** acknowledging input.

The stepping up control input (**SELECTOR 1 STEP-UP**) and the three-bit control inputs (**SELECTOR 1 3BIT A0** through **A2**) lock-out mutually: once the stepping up sequence is initiated, the three-bit control input is inactive; once the three-bit control sequence is initiated, the stepping up input is inactive.

**SELECTOR 1 3BIT MODE** — This setting defines the selector mode of operation. When set to “Time-out,” the selector changes its position after a pre-defined period of inactivity at the control input. The change is automatic and does not require explicit confirmation to change the selector position. When set to “Acknowledge,” the selector changes its position only after confirmation via a separate acknowledging signal. If the acknowledging signal does not appear within a pre-defined period of time, the selector rejects the change and an alarm established by invoking the **SELECTOR BIT ALARM** FlexLogic operand for three seconds.

**SELECTOR 1 3BIT ACK** — This setting specifies an acknowledging input for the three-bit control input. The pre-selected position is applied on the rising edge of the assigned FlexLogic operand. This setting is active only under the “Acknowledge” mode of operation. The acknowledging signal must appear within the time defined by the **SELECTOR TIME-OUT** setting after the last activity of the three-bit control inputs. Note that the stepping up control input and three-bit control input have independent acknowledging signals (**SELECTOR 1 ACK** and **SELECTOR 1 3BIT ACK**, accordingly).

**SELECTOR 1 POWER-UP MODE** — This setting specifies the element behavior on power up of the relay.

When set to “Restore,” the last position of the selector (stored in the non-volatile memory) is restored after powering up the relay. If the position restored from memory is out of range, position 0 (no output operand selected) is applied and an alarm is set (**SELECTOR 1 PWR ALARM**).

When set to “Synchronize,” the selector switch acts as follows. For two power cycles, the selector applies position 0 to the switch and activates **SELECTOR 1 PWR ALARM**. After two power cycles expire, the selector synchronizes to the position dictated by the three-bit control input. This operation does not wait for time-out or the acknowledging input. When the synchronization attempt is unsuccessful (that is, the three-bit input is not available (0,0,0) or out of range), then the selector switch output is set to position 0 (no output operand selected) and an alarm is established (**SELECTOR 1 PWR ALARM**).

The operation of “Synch/Restore” mode is similar to the “Synchronize” mode. The only difference is that after an unsuccessful synchronization attempt, the switch attempts to restore the position stored in the relay memory. The “Synch/Restore” mode is useful for applications where the selector switch is employed to change the setting group in redundant (two relay) protection schemes.

**SELECTOR 1 EVENTS** — If enabled, the following events are logged:

Event name	Description
SELECTOR 1 POS Z	Selector 1 changed its position to Z
SELECTOR 1 STP ALARM	The selector position pre-selected via the stepping up control input has not been confirmed before the time out
SELECTOR 1 BIT ALARM	The selector position pre-selected via the three-bit control input has not been confirmed before the time out

The following figures illustrate the operation of the selector switch. In these diagrams, “T” represents a time-out setting.

Figure 5-150: Time-out mode

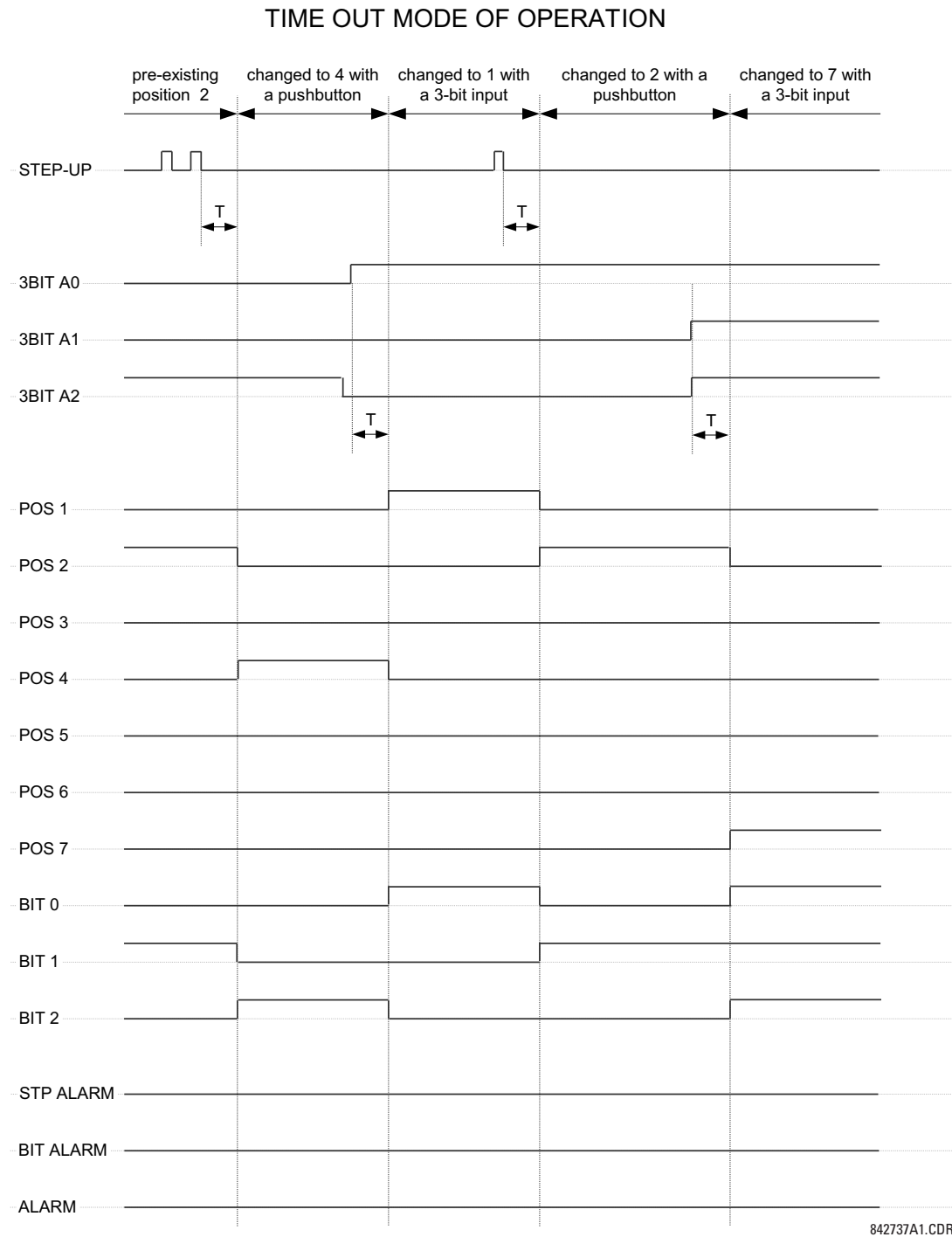
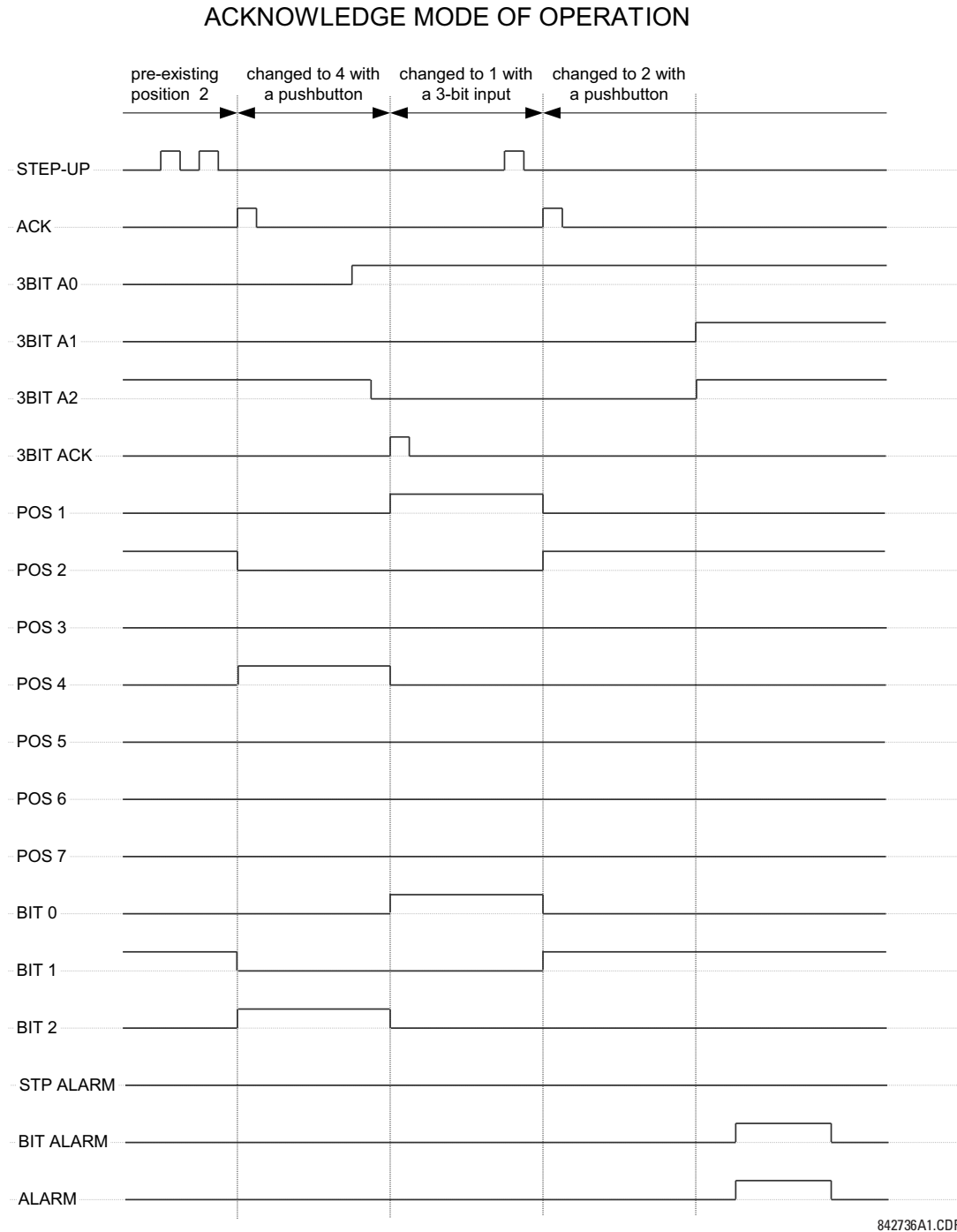


Figure 5-151: Acknowledge mode



### Application example

Consider an application where the selector switch is used to control setting groups 1 through 4 in the relay. The setting groups are to be controlled from both user-programmable pushbutton 1 and from an external device via contact inputs 1 through 3. The active setting group is to be available as an encoded three-bit word to the external device and SCADA via output contacts 1 through 3. The pre-selected setting group is to be applied automatically after five seconds of inactivity of the control inputs. When the relay powers up, it is to synchronize the setting group to the three-bit control input.

Make the following changes to setting group control in the **SETTINGS** ⇒ **CONTROL ELEMENTS** ⇒ **SETTING GROUPS** menu:

**SETTING GROUPS FUNCTION:** "Enabled"  
**SETTING GROUPS BLK:** "Off"  
**GROUP 2 ACTIVATE ON:** "SELECTOR 1 POS 2"  
**GROUP 3 ACTIVATE ON:** "SELECTOR 1 POS 3"  
**GROUP 4 ACTIVATE ON:** "SELECTOR 1 POS 4"  
**GROUP 5 ACTIVATE ON:** "Off"  
**GROUP 6 ACTIVATE ON:** "Off"

Make the following changes to selector switch element in the **SETTINGS** ⇒ **CONTROL ELEMENTS** ⇒ **SELECTOR SWITCH** ⇒ **SELECTOR SWITCH 1** menu to assign control to user programmable pushbutton 1 and contact inputs 1 through 3:

**SELECTOR 1 FUNCTION:** "Enabled"  
**SELECTOR 1 FULL-RANGE:** "4"  
**SELECTOR 1 STEP-UP MODE:** "Time-out"  
**SELECTOR 1 TIME-OUT:** "5.0 s"  
**SELECTOR 1 STEP-UP:** "PUSHBUTTON 1 ON"  
**SELECTOR 1 ACK:** "Off"  
**SELECTOR 1 3BIT A0:** "CONT IP 1 ON"  
**SELECTOR 1 3BIT A1:** "CONT IP 2 ON"  
**SELECTOR 1 3BIT A2:** "CONT IP 3 ON"  
**SELECTOR 1 3BIT MODE:** "Time-out"  
**SELECTOR 1 3BIT ACK:** "Off"  
**SELECTOR 1 POWER-UP MODE:** "Synchronize"

Now, assign the contact output operation (assume the H6E module) to the selector switch element by making the following changes in the **SETTINGS** ⇒ **INPUTS/OUTPUTS** ⇒ **CONTACT OUTPUTS** menu:

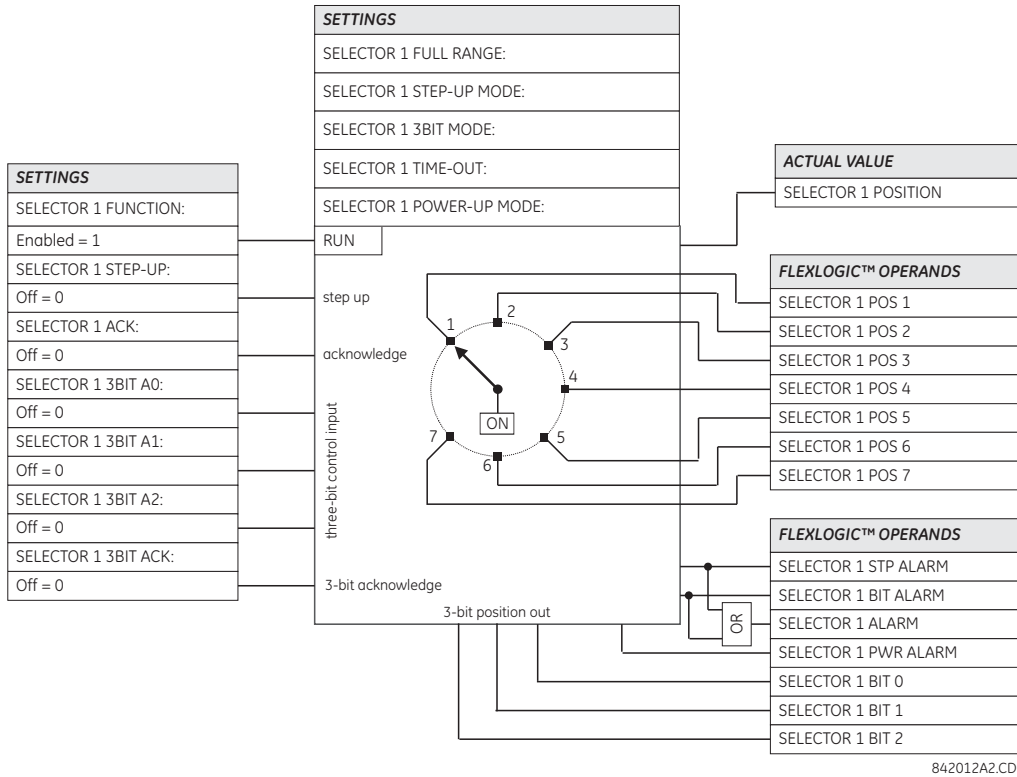
**OUTPUT H1 OPERATE:** "SELECTOR 1 BIT 0"  
**OUTPUT H2 OPERATE:** "SELECTOR 1 BIT 1"  
**OUTPUT H3 OPERATE:** "SELECTOR 1 BIT 2"

Finally, assign configure user-programmable pushbutton 1 by making the following changes in the **SETTINGS** ⇒ **PRODUCT SETUP** ⇒ **USER-PROGRAMMABLE PUSHBUTTONS** ⇒ **USER PUSHBUTTON 1** menu:

**PUSHBUTTON 1 FUNCTION:** "Self-reset"  
**PUSHBUTTON 1 DROP-OUT TIME:** "0.10 s"

The figure shows the logic for the selector switch.

Figure 5-152: Selector switch logic



### 5.8.5 Underfrequency (ANSI 81U)

SETTINGS ⇄ CONTROL ELEMENTS ⇄ UNDERFREQUENCY ⇄ UNDERFREQUENCY 1(6)

■ UNDERFREQUENCY 1	⇄	UNDFREQ 1 FUNCTION: Disabled	Range: Disabled, Enabled
	⇄	UNDFREQ 1 BLOCK: Off	Range: FlexLogic operand
	⇄	UNDFREQ 1 SOURCE: SRC 1	Range: SRC 1, SRC 2, SRC 3, SRC 4
	⇄	UNDFREQ 1 MIN VOLT/AMP: 0.10 pu	Range: 0.10 to 1.25 pu in steps of 0.01
	⇄	UNDFREQ 1 PICKUP: 59.50 Hz	Range: 20.00 to 65.00 Hz in steps of 0.01
	⇄	UNDFREQ 1 PICKUP DELAY: 2.000 s	Range: 0.000 to 65.535 s in steps of 0.001
	⇄	UNDFREQ 1 RESET DELAY : 2.000 s	Range: 0.000 to 65.535 s in steps of 0.001
	⇄	UNDFREQ 1 TARGET: Self-reset	Range: Self-reset, Latched, Disabled
	⇄	UNDFREQ 1 EVENTS: Disabled	Range: Disabled, Enabled

There are six identical underfrequency elements, numbered 1 through 6.



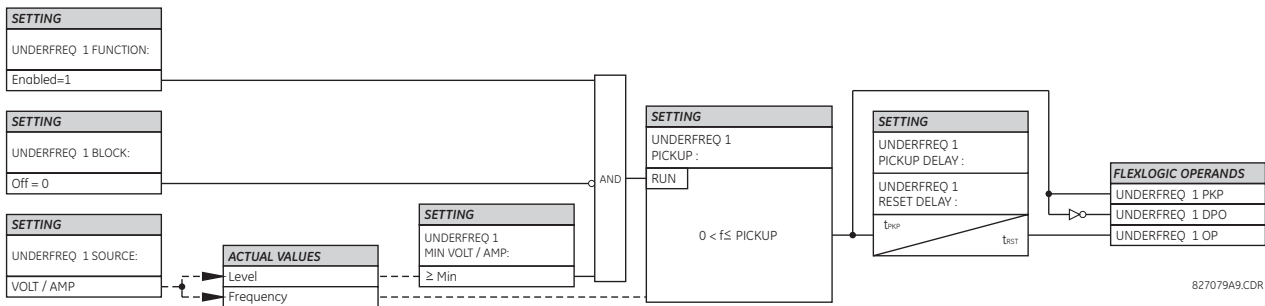
The steady-state frequency of a power system is a certain indicator of the existing balance between the generated power and the load. Whenever this balance is disrupted through the loss of an important generating unit or the isolation of part of the system from the rest of the system, the effect is a reduction in frequency. If the control systems of the system generators do not respond fast enough, the system can collapse. A reliable method to quickly restore the balance between load and generation is to automatically disconnect selected loads, based on the actual system frequency. This technique, called “load-shedding,” maintains system integrity and minimize widespread outages. After the frequency returns to normal, the load can be restored automatically or manually.

**UNDERFREQ 1 SOURCE** — This setting is used to select the source for the signal to be measured. The element first checks for a live phase voltage available from the selected source. If voltage is not available, the element attempts to use a phase current. If neither voltage nor current is available, the element does not operate, as it does not measure a parameter below the minimum voltage/current setting.

**UNDERFREQ 1 MIN VOLT/AMP** — Selects the minimum per unit voltage or current level required to allow the underfrequency element to operate. This threshold is used to prevent an incorrect operation because there is no signal to measure.

**UNDERFREQ 1 PICKUP** — Selects the level at which the underfrequency element is to pickup. For example, if the system frequency is 60 Hz and the load shedding is required at 59.5 Hz, the setting is 59.50 Hz.

Figure 5-153: Underfrequency logic



### 5.8.6 Overfrequency (ANSI 810)

SETTINGS ⇄ CONTROL ELEMENTS ⇄ OVERFREQUENCY ⇄ OVERFREQUENCY 1(4)

■ OVERFREQUENCY 1	↔	OVERFREQ 1 FUNCTION: Disabled	Range: Disabled, Enabled
	↕	OVERFREQ 1 BLOCK: Off	Range: FlexLogic operand
	↕	OVERFREQ 1 SOURCE: SRC 1	Range: SRC 1, SRC 2, SRC 3, SRC 4
	↕	OVERFREQ 1 PICKUP: 60.50 Hz	Range: 20.00 to 65.00 Hz in steps of 0.01
	↕	OVERFREQ 1 PICKUP DELAY: 0.500 s	Range: 0.000 to 65.535 s in steps of 0.001
	↕	OVERFREQ 1 RESET DELAY: 0.500 s	Range: 0.000 to 65.535 s in steps of 0.001
	↕	OVERFREQ 1 TARGET: Self-reset	Range: Self-reset, Latched, Disabled
	↑	OVERFREQ 1 EVENTS: Disabled	Range: Disabled, Enabled

There are four overfrequency elements, numbered 1 through 4.

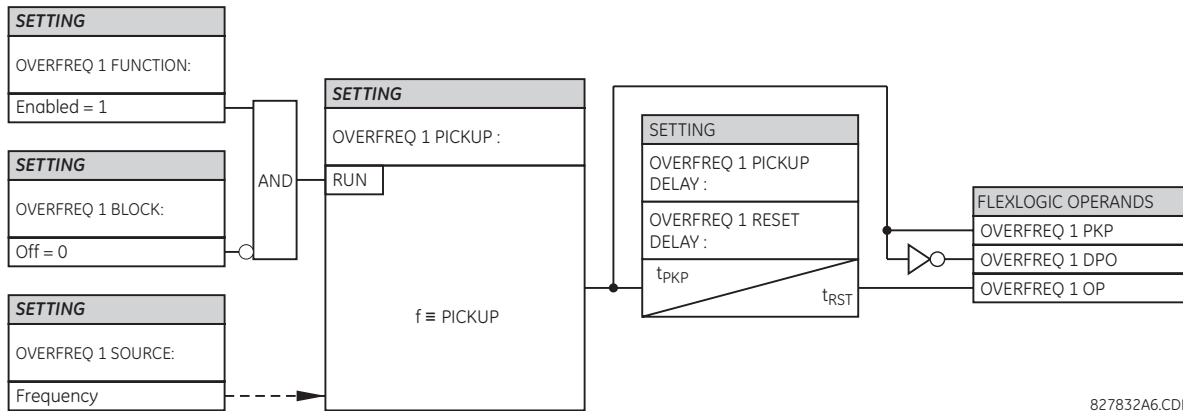
A frequency calculation for a given source is made on the input of a voltage or current channel, depending on which is available. The channels are searched for the signal input in the following order: voltage channel A, auxiliary voltage channel, current channel A, and ground current channel. The first available signal is used for frequency calculation.

The steady-state frequency of a power system is an indicator of the existing balance between the generated power and the load. Whenever this balance is disrupted through the disconnection of significant load or the isolation of a part of the system that has a surplus of generation, the effect is an increase in frequency. If the control systems of the generators do not respond fast enough, to quickly ramp the turbine speed back to normal, the overspeed can lead to the turbine trip. The overfrequency element can be used to control the turbine frequency ramp down at a generating location. This element can also be used for feeder reclosing as part of the "after load shedding restoration."

The **OVERFREQ 1 SOURCE** setting selects the source for the signal to be measured.

The **OVERFREQ 1 PICKUP** setting selects the level at which the overfrequency element is to pickup.

Figure 5-154: Overfrequency logic

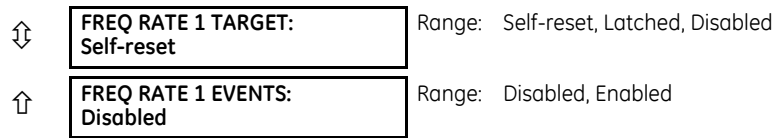


827832A6.CDR

### 5.8.7 Frequency rate of change (ANSI 81R)

SETTINGS ⇌ CONTROL ELEMENTS ⇌ FREQUENCY RATE OF CHANGE ⇌ FREQUENCY RATE OF CHANGE 1(4)

<ul style="list-style-type: none"> <li>■ FREQUENCY RATE</li> <li>■ OF CHANGE 1</li> </ul>	⇌	<b>FREQ RATE 1 FUNCTION: Disabled</b> Range: Disabled, Enabled
	⇌	<b>FREQ RATE 1 SOURCE: SRC 1</b> Range: SRC 1, SRC 2, SRC 3, SRC 4
	⇌	<b>FREQ RATE 1 TREND: Increasing</b> Range: Increasing, Decreasing, Bi-directional
	⇌	<b>FREQ RATE 1 PICKUP: 0.50 Hz/sec</b> Range: 0.10 to 15.00 Hz/sec in steps of 0.01
	⇌	<b>FREQ RATE 1 OV SUPV PICKUP: 0.700 pu</b> Range: 0.100 to 3.000 pu in steps of 0.001
	⇌	<b>FREQ RATE 1 OC SUPV PICKUP: 0.200 pu</b> Range: 0.020 to 30.000 pu in steps of 0.001
	⇌	<b>FREQ RATE 1 MIN FREQUENCY: 45.00 Hz</b> Range: 20.00 to 80.00 Hz in steps of 0.01
	⇌	<b>FREQ RATE 1 MAX FREQUENCY: 65.00 Hz</b> Range: 20.00 to 80.00 Hz in steps of 0.01
	⇌	<b>FREQ RATE 1 PICKUP DELAY: 0.000 s</b> Range: 0 to 65.535 s in steps of 0.001
	⇌	<b>FREQ RATE 1 RESET DELAY: 0.000 s</b> Range: 0 to 65.535 s in steps of 0.001
	⇌	<b>FREQ RATE 1 BLOCK: Off</b> Range: FlexLogic operand



The element responds to rate of change of frequency with voltage, current and frequency supervision.

**FREQ RATE 1 TREND** — This setting configures the element to respond to increasing or decreasing frequency, or to frequency change in either direction.

**FREQ RATE 1 PICKUP** — This setting specifies an intended  $df/dt$  pickup threshold. For applications monitoring a decreasing trend, set **FREQ RATE 1 TREND** to “Decreasing” and specify the pickup threshold accordingly. The operating condition is:  $-df/dt > \text{Pickup}$ .

For applications monitoring an increasing trend, set **FREQ RATE 1 TREND** to “Increasing” and specify the pickup threshold accordingly. The operating condition is:  $df/dt > \text{Pickup}$ .

For applications monitoring rate of change of frequency in any direction set **FREQ RATE 1 TREND** to “Bi-Directional” and specify the pickup threshold accordingly. The operating condition is:  $\text{abs}(df/dt) > \text{Pickup}$ .

**FREQ RATE 1 OV SUPV PICKUP** — This setting defines the minimum voltage level required for operation of the element. The supervising function responds to the positive-sequence voltage. Use overvoltage supervision to prevent operation under specific system conditions, such as faults.

**FREQ RATE 1 OC SUPV PICKUP** — This setting defines minimum current level required for operation of the element. The supervising function responds to the positive-sequence current. Typical application includes load shedding. Set the pickup threshold to 0.020 if no overcurrent supervision is required.

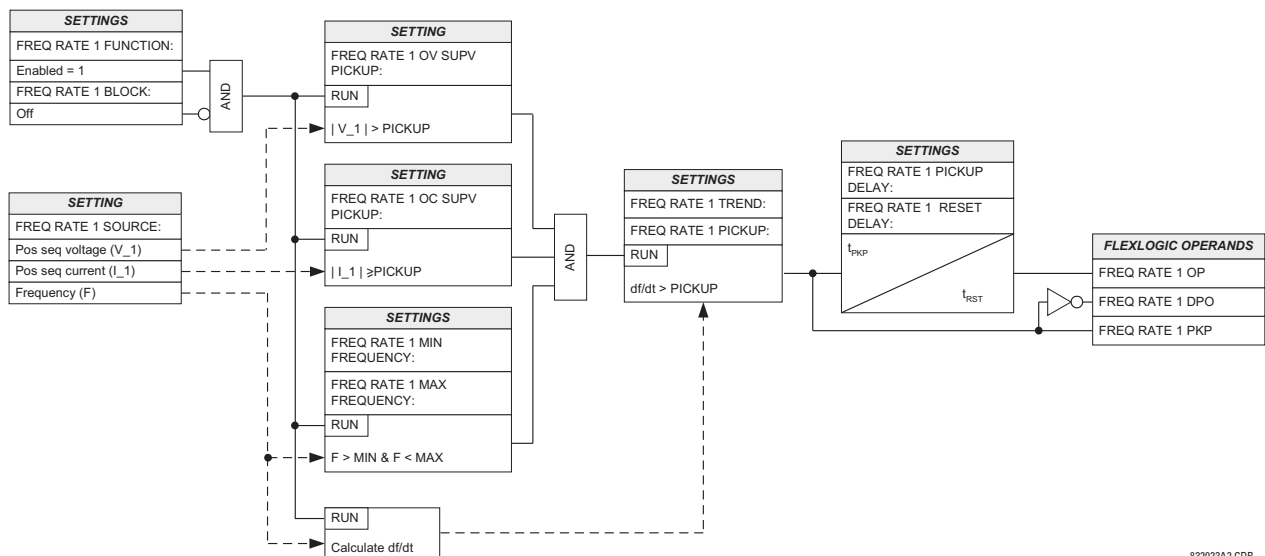
**FREQ RATE 1 MIN FREQUENCY** — This setting defines the minimum frequency level required for operation of the element. The setting can be used to effectively block the feature based on frequency. For example, if the intent is to monitor an increasing trend but only if the frequency is already above certain level, set this setting to the required frequency level.

**FREQ RATE 1 MAX FREQUENCY** — This setting defines the maximum frequency level required for operation of the element. The setting can be used to effectively block the feature based on frequency. For example, if the intent is to monitor a decreasing trend but only if the frequency is already below a certain level (such as for load shedding), set this setting to the required frequency level.



If the signal source assigned to the frequency rate of change element is only set to auxiliary VT, then the minimum voltage supervision is 3 V.

Figure 5-155: Frequency rate of change logic

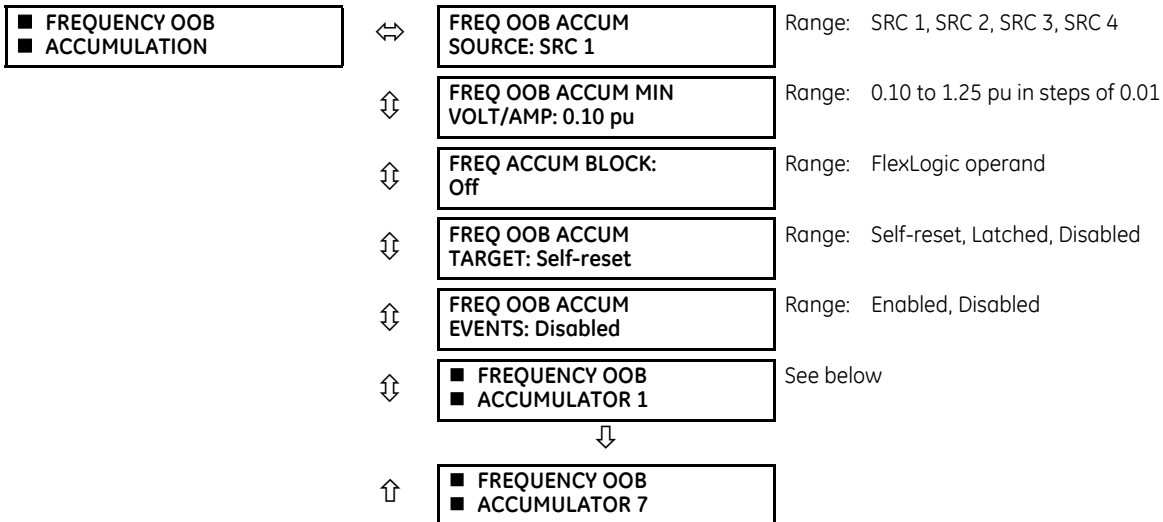


832023A2.CDR

## 5.8.8 Frequency out-of-band accumulation

### 5.8.8.1 Menu

SETTINGS ⇒ CONTROL ELEMENTS ⇒ FREQUENCY OOB ACCUMULATION



The turbine portion of a generator is designed to operate in a narrow frequency range around the nominal, typically  $\pm 5\%$ . As the turbine overspeeds (typically due to load rejection) or coasts down, the turbine passes through operating frequencies where the turbine blades find stimulus at their natural frequencies. Blade vibrations at these natural frequencies result in stress on the blades that is accumulated and can result in cracking in some parts of the blade structure, most likely the tie wires or blade covers. Though typically not catastrophic, the stress can change the vibration behavior of the blade so that they can have natural resonances closer to the normal operating frequency.

This element provides diagnostic information and alarms based on the accumulated off-nominal frequency operation time of a turbine over several frequency bands, that can then be used to schedule maintenance or other action.

The available setting of an upper and lower frequency for each band enables the user to overlap bands of frequencies in the accumulation function. The accumulation function in any band can be blocked as wanted. For example, accumulation can be blocked during an out-of-service condition as set via an input to the relay.

Settings are described as follows and apply to all accumulators.

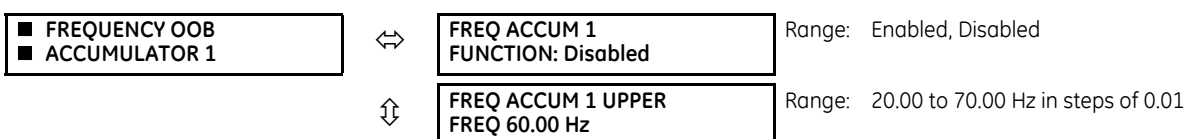
**FREQ OOB ACCUM SOURCE** — Selects the source for the signal to be measured. The element first checks for a live phase voltage available from the selected source. If voltage is not available, the element attempts to use a phase current. If neither voltage nor current is available, the element does not operate, as it does not measure a parameter below the minimum voltage/current setting.

**FREQ OOB ACCUM MIN VOLT/AMP** — This setting specifies the minimum per-unit positive-sequence voltage or current level required to allow the frequency out-of-band accumulators to operate. This threshold is used to prevent an incorrect accumulation when operating quantity is too low.

**FREQ ACCUM BLOCK** — This setting selects a FlexLogic operand to block out-of-band frequency accumulation in all bands. This is typically required to avoid unnecessary accumulation when relay testing is being performed.

### 5.8.8.2 Accumulators 1 to 7

SETTINGS ⇒ CONTROL ELEMENTS ⇒ FREQUENCY OOB ACCUMULATION ⇒ FREQUENCY OOB ACCUMULATOR 1(7)



⇕	<b>FREQ ACCUM 1 LOWER</b> <b>FREQ 60.00 Hz</b>	Range: 20.00 to 70.00 Hz in steps of 0.01
⇕	<b>FREQ ACCUM 1 TIME</b> <b>LIMIT: 200 s</b>	Range: 1 to 65535 s in steps of 1
↑	<b>FREQ ACCUM 1 TIME</b> <b>PRESET: 0 s</b>	Range: 0 to 65535 s in steps of 1

Seven frequency out-of-band accumulators are available. The following settings are available for each accumulator.

**FREQ ACCUM 1 FUNCTION** — Enables and disables a particular frequency band.

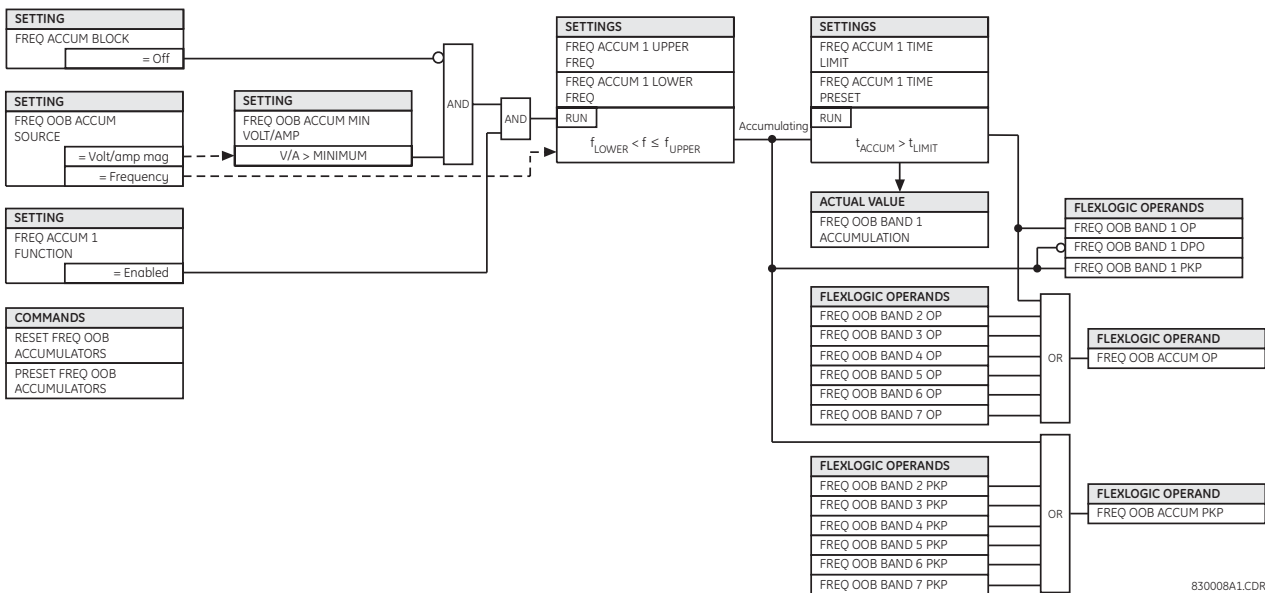
**FREQ ACCUM 1 UPPER FREQ** — Specifies the upper frequency value, in Hz, below which band 1 values start to accumulate. This upper frequency value must be greater than the lower frequency value.

**FREQ ACCUM 1 LOWER FREQ** — Specifies the lower frequency value, in Hz, above which band 1 values start to accumulate. This lower frequency value must be less than the upper frequency value.

**FREQ ACCUM 1 TIME LIMIT** — Specifies the accumulation time, in seconds, at which the overfrequency accumulation band exceeds the overfrequency accumulation limit and operates.

**FREQ ACCUM 1 TIME PRESET** — Allows the transfer of accumulated frequency time of operation values from a previous hardware platform to a new platform, or, given that some knowledge of the operation of the turbine is known, starts accumulation at a user-specified value.

Figure 5-156: Frequency out-of-band accumulation logic



### 5.8.9 Synchrocheck (ANSI 25)

SETTINGS ⇕ CONTROL ELEMENTS ⇕ SYNCHROCHECK ⇕ SYNCHROCHECK 1(4)

<div style="display: flex; align-items: center;"> <div style="width: 15px; height: 15px; background-color: black; margin-right: 5px;"></div> <span>SYNCHROCHECK 1</span> </div>	↔	<b>SYNCHK1 FUNCTION:</b> Disabled	Range: Disabled, Enabled
⇕		<b>SYNCHK1 BLOCK:</b> Off	Range: FlexLogic operand
⇕		<b>SYNCHK1 V1 SOURCE:</b> SRC 1	Range: SRC 1, SRC 2, SRC 3, SRC 4
⇕		<b>SYNCHK1 V2 SOURCE:</b> SRC 2	Range: SRC 1, SRC 2, SRC 3, SRC 4

↕	<b>SYNCHK1 MAX VOLT</b> DIFF: 10000 V	Range: 0 to 400000 V in steps of 1
↕	<b>SYNCHK1 MAX ANGLE</b> DIFF: 30°	Range: 0 to 100° in steps of 1
↕	<b>SYNCHK1 MAX FREQ</b> DIFF: 1.00 Hz	Range: 0.00 to 2.00 Hz in steps of 0.01
↕	<b>SYNCHK1 MAX FREQ</b> HYSTERESIS: 0.06 Hz	Range: 0.00 to 0.10 Hz in steps of 0.01
↕	<b>SYNCHK1 SYNC CLOSE:</b> Off	Range: FlexLogic operand
↕	<b>SYNCHK1 S-CLS MAX</b> dF: 0.50 Hz	Range: 0.10 to 2.00 Hz in steps of 0.01
↕	<b>SYNCHK1 S-CLS MIN</b> dF: 0.10 Hz	Range: 0.00 to 1.00 Hz in steps of 0.01
↕	<b>SYNCHK1 S-CLS BRK</b> TIME: 0.035 s	Range: 0.000 to 0.500 s in steps of 0.001
↕	<b>SYNCHK1 V2 MAG CORR</b> FACTOR: 1.00	Range: 0.10 to 10.00 in steps of 0.01
↕	<b>SYNCHK1 V2 ANGLE</b> SHIFT: 0	Range: -180 to +180 degrees in steps of 1
↕	<b>SYNCHK1 DEAD SOURCE</b> SELECT: LV1 and DV2	Range: None, LV1 and DV2, DV1 and LV2, DV1 or DV2, DV1 Xor DV2, DV1 and DV2
↕	<b>SYNCHK1 DEAD V1</b> MAX VOLT: 0.30 pu	Range: 0.04 to 1.25 pu in steps of 0.01
↕	<b>SYNCHK1 DEAD V2</b> MAX VOLT: 0.30 pu	Range: 0.04 to 1.25 pu in steps of 0.01
↕	<b>SYNCHK1 LIVE V1</b> MIN VOLT: 0.70 pu	Range: 0.04 to 1.25 pu in steps of 0.01
↕	<b>SYNCHK1 LIVE V2</b> MIN VOLT: 0.70 pu	Range: 0.04 to 1.25 pu in steps of 0.01
↕	<b>SYNCHK1 TARGET:</b> Self-reset	Range: Self-reset, Latched, Disabled
↑	<b>SYNCHK1 EVENTS:</b> Disabled	Range: Disabled, Enabled

The synchronism check function supervises the paralleling of two parts of a system that are to be joined by the closure of a circuit breaker. The synchrocheck elements are typically used at locations where the two parts of the system are interconnected through at least one other point in the system.

Synchrocheck verifies that the voltages (V1 and V2) on the two sides of the supervised circuit breaker are within set limits of magnitude, angle, and frequency differences. The time that the two voltages remain within the admissible angle difference is determined by the setting of the phase angle difference  $\Delta\Phi$  and the frequency difference  $\Delta F$  (slip frequency). It can be defined as the time it takes the voltage phasor V1 or V2 to traverse an angle equal to  $2 \times \Delta\Phi$  at a frequency equal to the frequency difference  $\Delta F$ . This time is calculated by:

$$T = \frac{1}{\frac{360^\circ}{2 \times \Delta\Phi} \times \Delta F} \quad \text{Eq. 5-60}$$

where

$\Delta\Phi$  is phase angle difference in degrees

$\Delta F$  is frequency difference in Hz

If one or both sources are de-energized, the synchrocheck programming can allow for closing of the circuit breaker using undervoltage control to bypass the synchrocheck measurements (dead source function).

**SYNCHK1 V1 SOURCE** — This setting selects the source for voltage V1 (see the Notes section that follows).

**SYNCHK1 V2 SOURCE** — Selects the source for voltage V2, which must not be the same as used for the V1 (see Notes).

**SYNCHK1 MAX VOLT DIFF** — Selects the maximum primary voltage difference in volts between the two sources. A primary voltage magnitude difference between the two input voltages below this value is within the permissible limit for synchronism.

**SYNCHK1 MAX ANGLE DIFF** — Selects the maximum angular difference in degrees between the two sources. An angular difference between the two input voltage phasors below this value is within the permissible limit for synchronism.

**SYNCHK1 MAX FREQ HYSTERESIS** — Specifies the required hysteresis for the maximum frequency difference condition. The condition becomes satisfied when the frequency difference becomes lower than **SYNCHK1 MAX FREQ DIFF**. Once the Synchrocheck element has operated, the frequency difference must increase above the **SYNCHK1 MAX FREQ DIFF + SYNCHK1 MAX FREQ HYSTERESIS** sum to drop out (assuming the other two conditions, voltage and angle, remain satisfied).

**SYNCHK1 SYNC CLOSE** — Enables the dynamic mode of synchrocheck. When it is enabled, the location of where the present V2 vector will be arriving to synchronize (shown as V2' in the figures here) with breaker close time being taken into account will be predicted based on the measured slip frequency so that breaker close command can be issued in advance to ensure the synchronism at the time when the breaker is actually closed.

Figure 5-157: Synchrocheck plot for slip > 0 (slip = F2-F1)

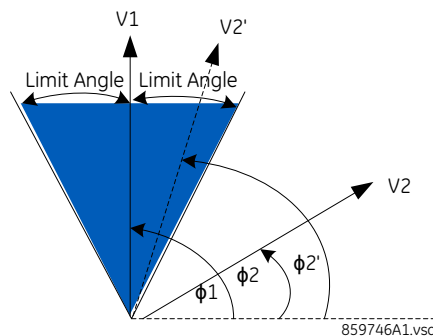
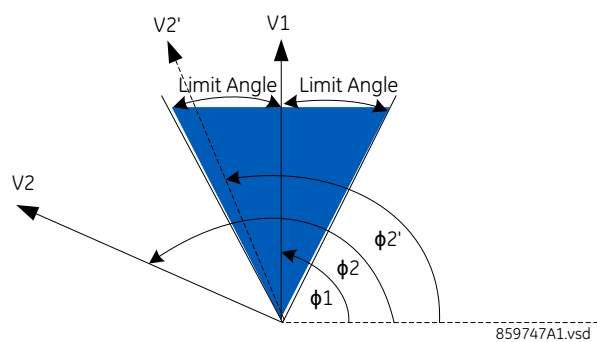


Figure 5-158: Synchrocheck plot for slip < 0 (slip = F2-F1)



**SYNCHK1 S-CLS MAX dF** — Specifies the maximum slip frequency allowed in Hz in the dynamic mode. The dynamic mode is disarmed when the slip frequency exceeds this setting.

**SYNCHK1 S-CLS MIN dF** — Specifies the minimum slip frequency allowed in Hz in the dynamic mode. The dynamic mode is disarmed when the slip frequency drops below this setting.

**SYNCHK1 S-CLS BRK TIME** — Specifies the breaker closing time in seconds.

**SYNCHK1 V2 MAG CORR FACTOR** — Specifies the magnitude correction factor of source V2. This setting is used for V2 magnitude compensation so that V2 magnitude can be directly compared with V1 magnitude. For example, when V1 and V2 are taken from 2 different windings of the transformer and at different voltage levels, the magnitude compensation must be performed before starting magnitude comparison in synchrocheck element.

**SYNCHK1 V2 ANGLE SHIFT** — Specifies the angle of source V2 that needs to be shifted so that V2 angle can be directly compared with V1 angle. For example, when V1 and V2 are taken from two different windings of the transformer and with different angle shift due to winding connections, the angle shift compensation must be performed before starting angle comparison in synchrocheck element.

**SYNCHK1 DEAD SOURCE SELECT** — Selects the combination of dead and live sources that bypass the synchronism check function and permit the breaker to be closed when one or both of the two voltages (V1 or/and V2) are below the maximum voltage threshold. A dead or live source is declared by monitoring the voltage level. Six options are available:

None — Dead Source function is disabled

LV1 and DV2 — Live V1 and Dead V2

DV1 and LV2 — Dead V1 and Live V2

DV1 or DV2 — Dead V1 or Dead V2

DV1 Xor DV2 — Dead V1 exclusive-or Dead V2 (one source is Dead and the other is Live)

DV1 and DV2 — Dead V1 and Dead V2

**SYNCHK1 DEAD V1 MAX VOLT** — Establishes a maximum voltage magnitude for V1 in 'pu'. Below this magnitude, the V1 voltage input used for synchrocheck is considered "Dead" or de-energized.

**SYNCHK1 DEAD V2 MAX VOLT** — Establishes a maximum voltage magnitude for V2 in 'pu'. Below this magnitude, the V2 voltage input used for synchrocheck is considered "Dead" or de-energized.

**SYNCHK1 LIVE V1 MIN VOLT** — Establishes a minimum voltage magnitude for V1 in 'pu'. Above this magnitude, the V1 voltage input used for synchrocheck is considered "Live" or energized.

**SYNCHK1 LIVE V2 MIN VOLT** — This setting establishes a minimum voltage magnitude for V2 in 'pu'. Above this magnitude, the V2 voltage input used for synchrocheck is considered "Live" or energized.

### Notes on the synchrocheck function

1. The selected sources for synchrocheck inputs V1 and V2 (which must not be the same source) can include both a three-phase and an auxiliary voltage. The relay automatically selects the specific voltages to be used by the synchrocheck element in accordance with the following table.

Number	V1 or V2 (source Y)	V2 or V1 (source Z)	Auto-selected combination		Auto-selected voltage
			Source Y	Source Z	
1	Phase VTs and Auxiliary VT	Phase VTs and Auxiliary VT	Phase	Phase	VAB
2	Phase VTs and Auxiliary VT	Phase VT	Phase	Phase	VAB
3	Phase VT	Phase VT	Phase	Phase	VAB
4	Phase VT and Auxiliary VT	Auxiliary VT	Phase	Auxiliary	V auxiliary (as set for source Z)
5	Auxiliary VT	Auxiliary VT	Auxiliary	Auxiliary	V auxiliary (as set for selected sources)

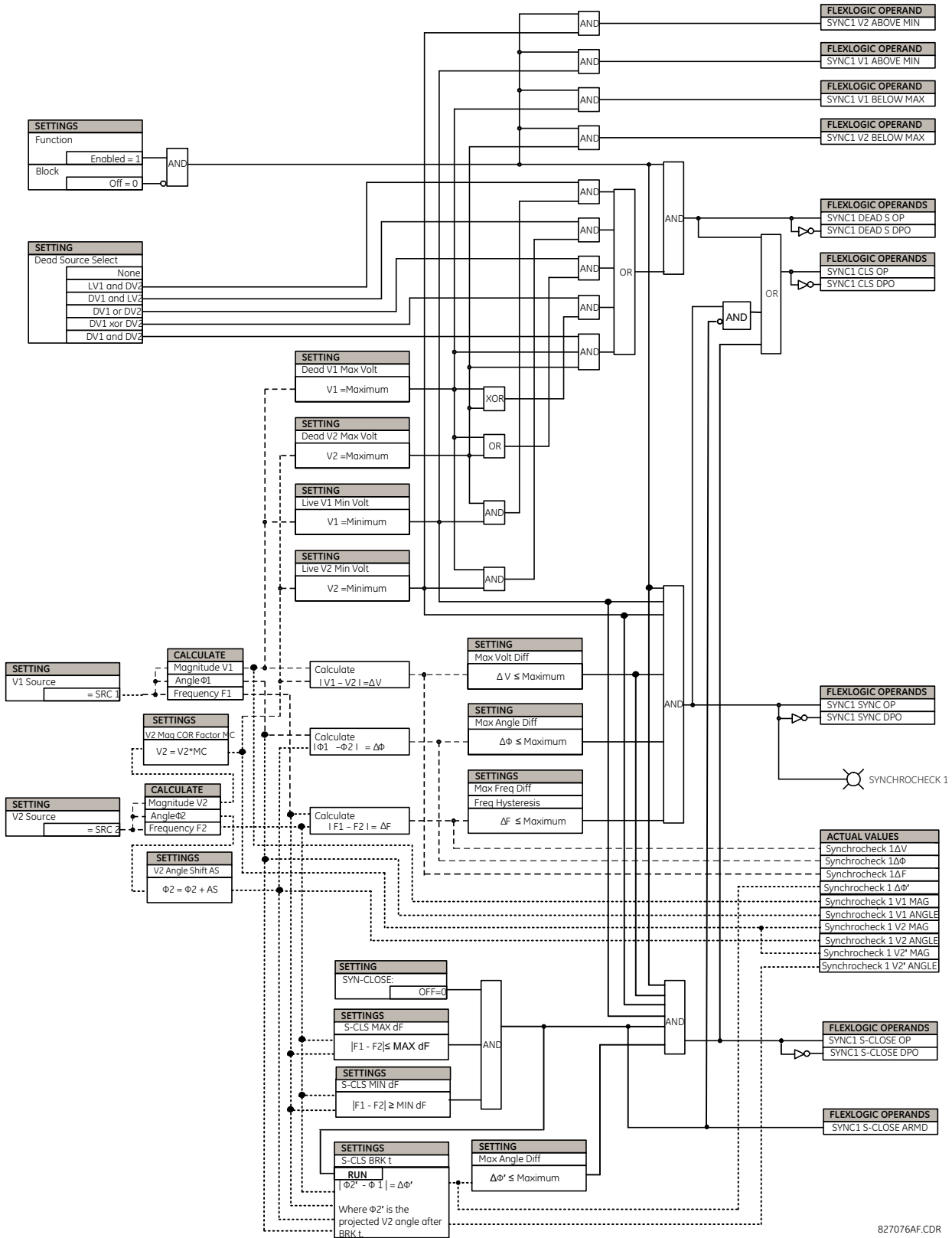
The voltages V1 and V2 are matched automatically so that the corresponding voltages from the two sources are used to measure conditions. A phase to phase voltage is used if available in both sources; if one or both of the Sources have only an auxiliary voltage, this voltage is used. For example, if an auxiliary voltage is programmed to VAG, the synchrocheck element automatically selects VAG from the other source. If the comparison is required on a specific voltage, the user can externally connect that specific voltage to auxiliary voltage terminals and then use this "Auxiliary Voltage" to check the synchronism conditions.



If using a single CT/VT module with both phase voltages and an auxiliary voltage, ensure that only the auxiliary voltage is programmed in one of the sources to be used for synchrocheck. An exception is that synchronism cannot be checked between Delta connected phase VTs and a Wye connected auxiliary voltage.

2. The relay measures frequency and Volts/Hz from an input on a given source with priorities as established by the configuration of input channels to the source. The relay uses the phase channel of a three-phase set of voltages if programmed as part of that source. The relay uses the auxiliary voltage channel only if that channel is programmed as part of the Source and a three-phase set is not.

Figure 5-159: Synchrocheck logic



## 5.8.10 Digital elements

SETTINGS ⇒ CONTROL ELEMENTS ⇒ DIGITAL ELEMENTS ⇒ DIGITAL ELEMENT 1(48)

■ DIGITAL ELEMENT 1 ■	↔	DIGITAL ELEMENT 1 FUNCTION: Disabled	Range: Disabled, Enabled
	⇅	DIG ELEM 1 NAME: Dig Element 1	Range: up to 16 alphanumeric characters
	⇅	DIG ELEM 1 INPUT: Off	Range: FlexLogic operand
	⇅	DIG ELEM 1 PICKUP DELAY: 0.000 s	Range: 0.000 to 999999.999 s in steps of 0.001
	⇅	DIG ELEM 1 RESET DELAY: 0.000 s	Range: 0.000 to 999999.999 s in steps of 0.001
	⇅	DIGITAL ELEMENT 1 PICKUP LED: Enabled	Range: Disabled, Enabled
	⇅	DIG ELEM 1 BLOCK: Off	Range: FlexLogic operand
	⇅	DIGITAL ELEMENT 1 TARGET: Self-reset	Range: Self-reset, Latched, Disabled
	↑	DIGITAL ELEMENT 1 EVENTS: Disabled	Range: Disabled, Enabled



Digital elements run once per power system cycle.

As such they can easily fail to react to an input signal or a block signal with a duration less than one power system cycle. This also means that digital element output can react up to one power system cycle later than the pickup and reset delay settings indicate.

Do not use digital elements with transient signals, such as communications commands. Do not use digital elements where random delays of up to one cycle cannot be tolerated, such as in high speed protection.

There are 48 identical digital elements available, numbered 1 to 48. A digital element can monitor any FlexLogic operand and present a target message and/or enable events recording depending on the output operand state. The digital element settings include a name to be referenced in any target message, a blocking input from any selected FlexLogic operand, and a timer for pickup and reset delays for the output operand.

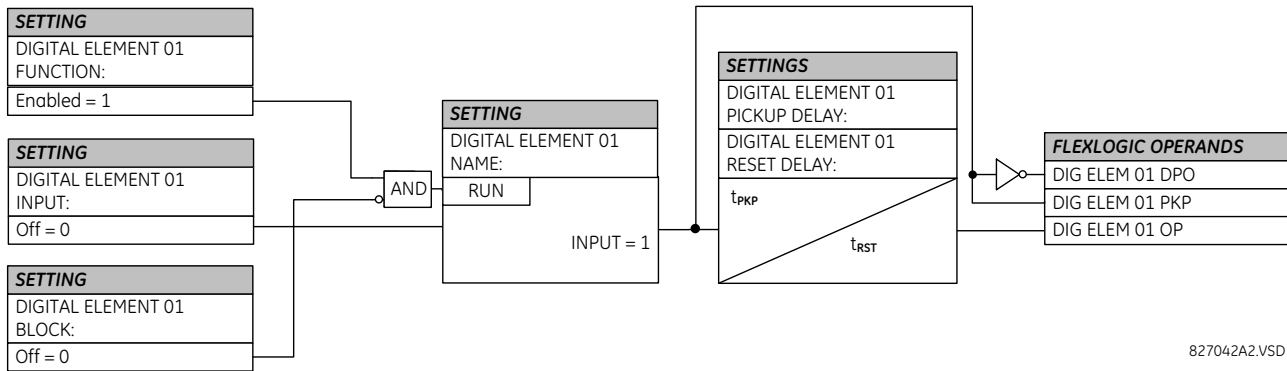
**DIGITAL ELEMENT 1 INPUT** — Selects a FlexLogic operand to be monitored by the digital element.

**DIGITAL ELEMENT 1 PICKUP DELAY** — Sets the required time delay from element pickup to element operation. If a pickup delay is not required, set to "0." To avoid nuisance alarms, set the delay greater than the operating time of the breaker.

**DIGITAL ELEMENT 1 RESET DELAY** — Sets the time delay to reset. If a reset delay is not required, set to "0."

**DIGITAL ELEMENT 1 PICKUP LED** — This setting enables or disabled the digital element pickup LED. When set to "Disabled," the operation of the pickup LED is blocked.

Figure 5-160: Digital element logic



827042A2.VSD

### Circuit monitoring applications

Some versions of the digital input modules include an active voltage monitor circuit connected across form-A contacts. The voltage monitor circuit limits the trickle current through the output circuit (see technical specifications for form-A).

As long as the current through the voltage monitor is above a threshold (see technical specifications for form-A), the **Cont Op 1 VOn** FlexLogic operand is set (for contact input 1—corresponding operands exist for each contact output). If the output circuit has a high resistance or the DC current is interrupted, the trickle current drops below the threshold and the **Cont Op 1 VOff** FlexLogic operand is set. Consequently, the state of these operands can be used as indicators of the integrity of the circuits in which form-A contacts are inserted.

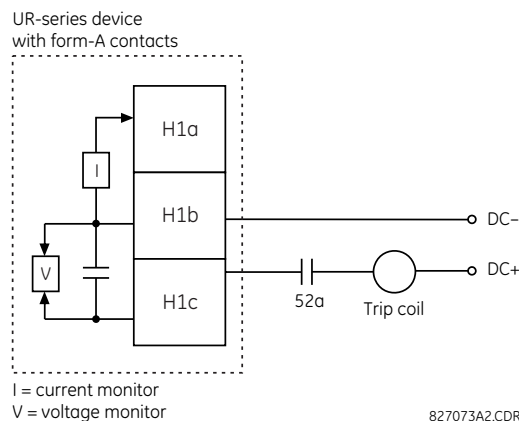
5

#### Example 1: Breaker trip circuit integrity monitoring

In many applications it is desired to monitor the breaker trip circuit integrity so that problems can be detected before a trip operation is required. The circuit is considered to be healthy when the voltage monitor connected across the trip output contact detects a low level of current, well below the operating current of the breaker trip coil. If the circuit presents a high resistance, the trickle current falls below the monitor threshold, and an alarm is declared.

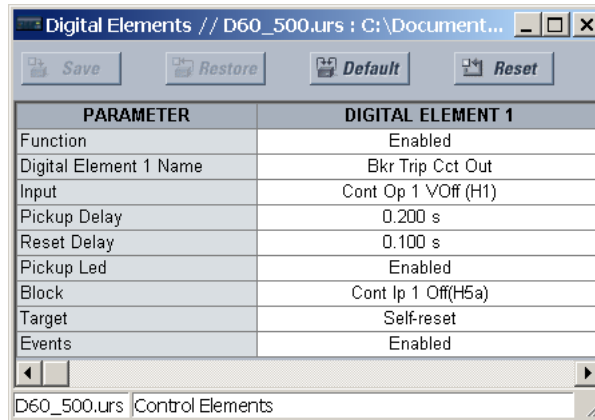
In most breaker control circuits, the trip coil is connected in series with a breaker auxiliary contact that is open when the breaker is open (see figure). To prevent unwanted alarms in this situation, the trip circuit monitoring logic must include the breaker position.

Figure 5-161: Trip circuit example 1



827073A2.CDR

Assume the output contact H1 is a trip contact. Using the contact output settings, this output is given an ID name; for example, "Cont Op 1." Assume a 52a breaker auxiliary contact is connected to contact input H7a to monitor breaker status. Using the contact input settings, this input is given an ID name, for example, "Cont Ip 1," and is set "On" when the breaker is closed. The settings to use digital element 1 to monitor the breaker trip circuit are indicated (EnerVista example shown).

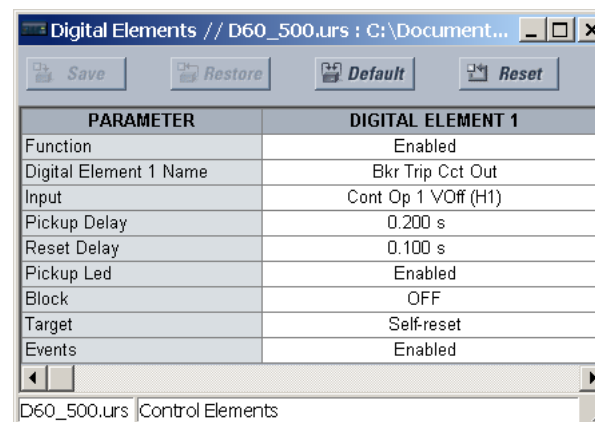


PARAMETER	DIGITAL ELEMENT 1
Function	Enabled
Digital Element 1 Name	Bkr Trip Cct Out
Input	Cont Op 1 VOff (H1)
Pickup Delay	0.200 s
Reset Delay	0.100 s
Pickup Led	Enabled
Block	Cont Ip 1 Off(H5a)
Target	Self-reset
Events	Enabled

D60\_500.urs | Control Elements

### Example 2: Breaker trip circuit integrity monitoring

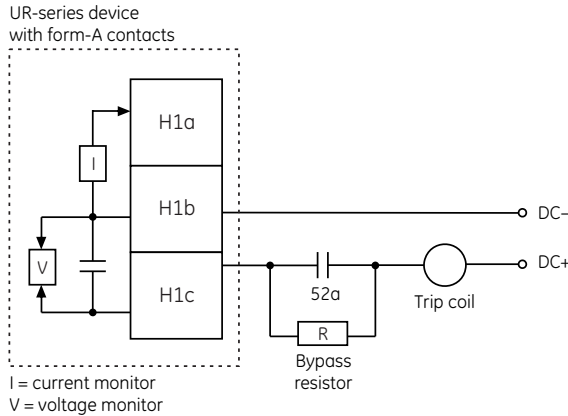
If it is required to monitor the trip circuit continuously, independent of the breaker position (open or closed), a method to maintain the monitoring current flow through the trip circuit when the breaker is open must be provided (as shown in the following figure). This can be achieved by connecting a suitable resistor (see figure) across the auxiliary contact in the trip circuit. In this case, it is not required to supervise the monitoring circuit with the breaker position – the **BLOCK** setting is selected to "Off." In this case, the settings are as follows (EnerVista example shown).



PARAMETER	DIGITAL ELEMENT 1
Function	Enabled
Digital Element 1 Name	Bkr Trip Cct Out
Input	Cont Op 1 VOff (H1)
Pickup Delay	0.200 s
Reset Delay	0.100 s
Pickup Led	Enabled
Block	OFF
Target	Self-reset
Events	Enabled

D60\_500.urs | Control Elements

Figure 5-162: Trip circuit example 2



Values for resistor "R"

Power supply	Resistance	Power
24 V DC	1000 Ω	2 W
30 V DC	5000 Ω	2 W
48 V DC	10000 Ω	2 W
110 V DC	25000 Ω	5 W
125 V DC	25000 Ω	5 W
250 V DC	50000 Ω	5 W

827074A3.CDR



The wiring connection for two examples above is applicable to both form-A contacts with voltage monitoring and solid-state contact with voltage monitoring.

### 5.8.11 Digital counters

SETTINGS ⇒ CONTROL ELEMENTS ⇒ DIGITAL COUNTERS ⇒ COUNTER 1(8)

■ COUNTER 1	↔	COUNTER 1 FUNCTION: Disabled	Range: Disabled, Enabled
■	↕	COUNTER 1 NAME: Counter 1	Range: up to 12 alphanumeric characters
	↕	COUNTER 1 UNITS:	Range: up to six alphanumeric characters
	↕	COUNTER 1 PRESET: 0	Range: -2,147,483,648 to +2,147,483,647
	↕	COUNTER 1 COMPARE: 0	Range: -2,147,483,648 to +2,147,483,647
	↕	COUNTER 1 UP: Off	Range: FlexLogic operand
	↕	COUNTER 1 DOWN: Off	Range: FlexLogic operand
	↕	COUNTER 1 BLOCK: Off	Range: FlexLogic operand
	↕	CNT1 SET TO PRESET: Off	Range: FlexLogic operand
	↕	COUNTER 1 RESET: Off	Range: FlexLogic operand
	↕	COUNT1 FREEZE/RESET: Off	Range: FlexLogic operand
	↑	COUNT1 FREEZE/COUNT: Off	Range: FlexLogic operand

There are eight identical digital counters, numbered from 1 to 8. A digital counter counts the number of state transitions from Logic 0 to Logic 1. The counter is used to count operations such as the pickups of an element, the changes of state of an external contact (for example, breaker auxiliary switch), or pulses from a watt-hour meter.

**COUNTER 1 UNITS** — Assigns a label to identify the unit of measure pertaining to the digital transitions to be counted. The units label appears in the corresponding actual values status.

**COUNTER 1 PRESET** — Sets the count to a required preset value before counting operations begin, as in the case where a substitute relay is to be installed in place of an in-service relay, or while the counter is running.

**COUNTER 1 COMPARE** — Sets the value to which the accumulated count value is compared. Three FlexLogic output operands are provided to indicate if the present value is 'more than (HI)', 'equal to (EQL)', or 'less than (LO)' the set value.

**COUNTER 1 UP** — Selects the FlexLogic operand for incrementing the counter. If an enabled UP input is received when the accumulated value is at the limit of +2,147,483,647 counts, the counter rolls over to -2,147,483,648.

**COUNTER 1 DOWN** — Selects the FlexLogic operand for decrementing the counter. If an enabled DOWN input is received when the accumulated value is at the limit of -2,147,483,648 counts, the counter rolls over to +2,147,483,647.

**COUNTER 1 BLOCK** — Selects the FlexLogic operand for blocking the counting operation. All counter operands are blocked.

**CNT1 SET TO PRESET** — Selects the FlexLogic operand used to set the count to the preset value. The counter sets to the preset value in the following situations:

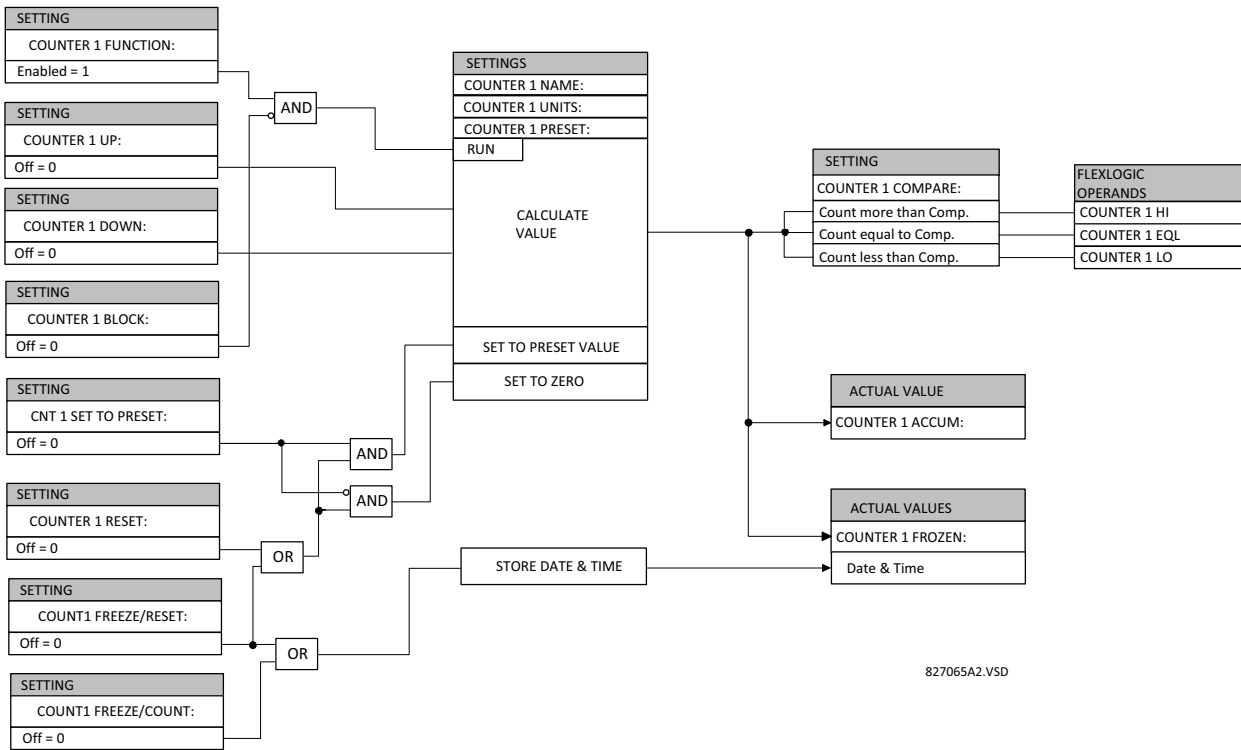
- When the counter is enabled and the **CNT1 SET TO PRESET** operand has the value 1 (when the counter is enabled and **CNT1 SET TO PRESET** operand is 0, the counter sets to 0)
- When the counter is running and the **CNT1 SET TO PRESET** operand changes the state from 0 to 1 (**CNT1 SET TO PRESET** changing from 1 to 0 while the counter is running has no effect on the count)
- When a reset or reset/freeze command is sent to the counter and the **CNT1 SET TO PRESET** operand has the value 1 (when a reset or reset/freeze command is sent to the counter and the **CNT1 SET TO PRESET** operand has the value 0, the counter sets to 0)

**COUNTER 1 RESET** — Selects the FlexLogic operand for setting the count to either "0" or the preset value depending on the state of the **CNT1 SET TO PRESET** operand.

**COUNTER 1 FREEZE/RESET** — Selects the FlexLogic operand for capturing (freezing) the accumulated count value into a separate register with the date and time of the operation, and resetting the count to "0."

**COUNTER 1 FREEZE/COUNT** — Selects the FlexLogic operand for capturing (freezing) the accumulated count value into a separate register with the date and time of the operation, and continuing counting. The present accumulated value and captured frozen value with the associated date/time stamp are available as actual values. If control power is interrupted, the accumulated and frozen values are saved into non-volatile memory during the power-down operation.

Figure 5-163: Digital counter logic

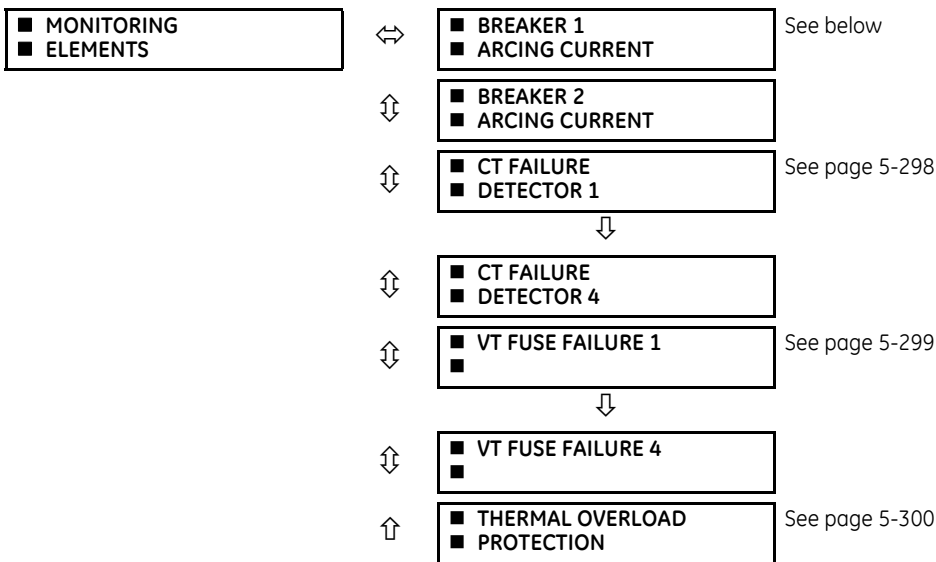


5

## 5.8.12 Monitoring elements

### 5.8.12.1 Menu

SETTINGS ⇌ CONTROL ELEMENTS ⇌ MONITORING ELEMENTS





### 5.8.12.2 Breaker arcing current

#### SETTINGS ⇌ CONTROL ELEMENTS ⇌ MONITORING ELEMENTS ⇌ BREAKER 1(2) ARCING CURRENT

<ul style="list-style-type: none"> <li>■ BREAKER 1</li> <li>■ ARCING CURRENT</li> </ul>	↔	BKR 1 ARC AMP FUNCTION: Disabled	Range: Disabled, Enabled	
	↕	BKR 1 ARC AMP SOURCE: SRC 1	Range: SRC 1, SRC 2, SRC 3, SRC 4	
	↕	BKR 1 ARC AMP INT-A: Off	Range: FlexLogic operand	
		↓		
	↕	BKR 1 ARC AMP INT-C: Off	Range: FlexLogic operand	
	↕	BKR 1 ARC AMP DELAY: 0.000 s	Range: 0.000 to 65.535 s in steps of 0.001	
	↕	BKR 1 ARC AMP LIMIT: 1000 kA <sup>2</sup> -cyc	Range: 0 to 50000 kA <sup>2</sup> -cycle in steps of 1	
	↕	BKR 1 INTERRUPTION RATING: 31.5 kA	Range: 0.0 to 100.0 kA in steps of 0.1	
	↕	BKR 1 CLR ARC AMPS: Off	Range: FlexLogic operand	
	↕	BKR 1 ARC AMP BLOCK: Off	Range: FlexLogic operand	
↕	BKR 1 ARC AMP TARGET: Self-reset	Range: Self-reset, Latched, Disabled		
↕	BKR 1 ARC AMP EVENTS: Disabled	Range: Disabled, Enabled		

There is one breaker arcing current element available per CT bank, with a minimum of two elements. This element calculates an estimate of the per-phase wear on the breaker contacts by measuring and integrating the current squared passing through the breaker contacts as an arc. These per-phase values are added to accumulated totals for each phase and compared to a programmed threshold value. When the threshold is exceeded in any phase, the relay can set an output operand to "1." The accumulated value for each phase can be displayed as an actual value.

The operation of the scheme is shown in the following logic diagram. The same output operand that is selected to operate the output relay used to trip the breaker, indicating a tripping sequence has begun, is used to initiate this feature. A time delay is introduced between initiation and the starting of integration to prevent integration of current flow through the breaker before the contacts have parted. This interval includes the operating time of the output relay, any other auxiliary relays, and the breaker mechanism. For maximum measurement accuracy, measure the interval between change-of-state of the operand (from 0 to 1) and contact separation for the specific installation. Integration of the measured current continues for 100 ms, which is expected to include the total arcing period.

The feature is programmed to perform fault duration calculations. Fault duration is defined as a time between operation of the disturbance detector occurring before initiation of this feature, and reset of an internal low-set overcurrent function. Correction is implemented to account for a non-zero reset time of the overcurrent function.

Breaker arcing currents and fault duration values are available under the **ACTUAL VALUES** ⇌ **RECORDS** ⇌ **MAINTENANCE** ⇌ **BREAKER 1(2)** menus.

**BKR 1 ARC AMP INT-A(C)** — Select the same output operands that are configured to operate the output relays used to trip the breaker. In three-pole tripping applications, configure the same operand to initiate arcing current calculations for poles A, B, and C of the breaker. In single-pole tripping applications, configure per-pole tripping operands to initiate the calculations for the poles that are actually tripped.

**BKR 1 ARC AMP DELAY** — This setting is used to program the delay interval between the time the tripping sequence is initiated and the time the breaker contacts are expected to part, starting the integration of the measured current.

**BKR 1 ARC AMP LIMIT** — Selects the threshold value above which the output operand is set.

**BKR 1 CLR ARC AMPS** — Selects a FLexLogic Operand to clear the accumulated  $I^2t$  values (kA<sup>2</sup>-cycle), reset fault duration items (breaker operating time), clear ARCING AMPS (kA<sup>2</sup>-cycle) and AMP MAX (kA) values of the last event.

**BKR 1 INTERRUPTION RATING** — This setting specifies the maximum symmetrical interruption rating of the circuit breaker.

**Figure 5-164: Arcing current measurement**

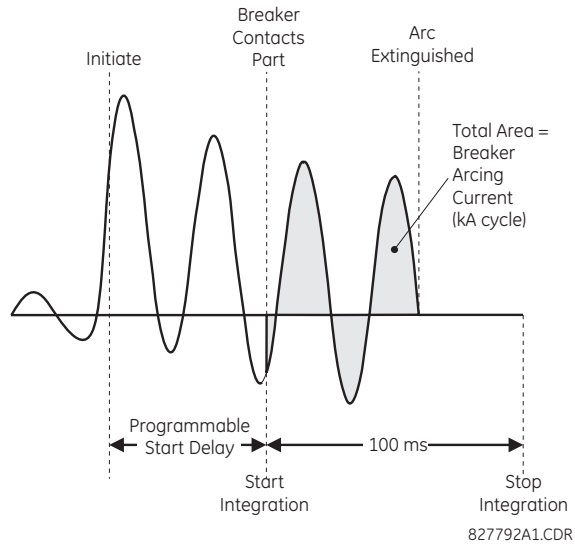
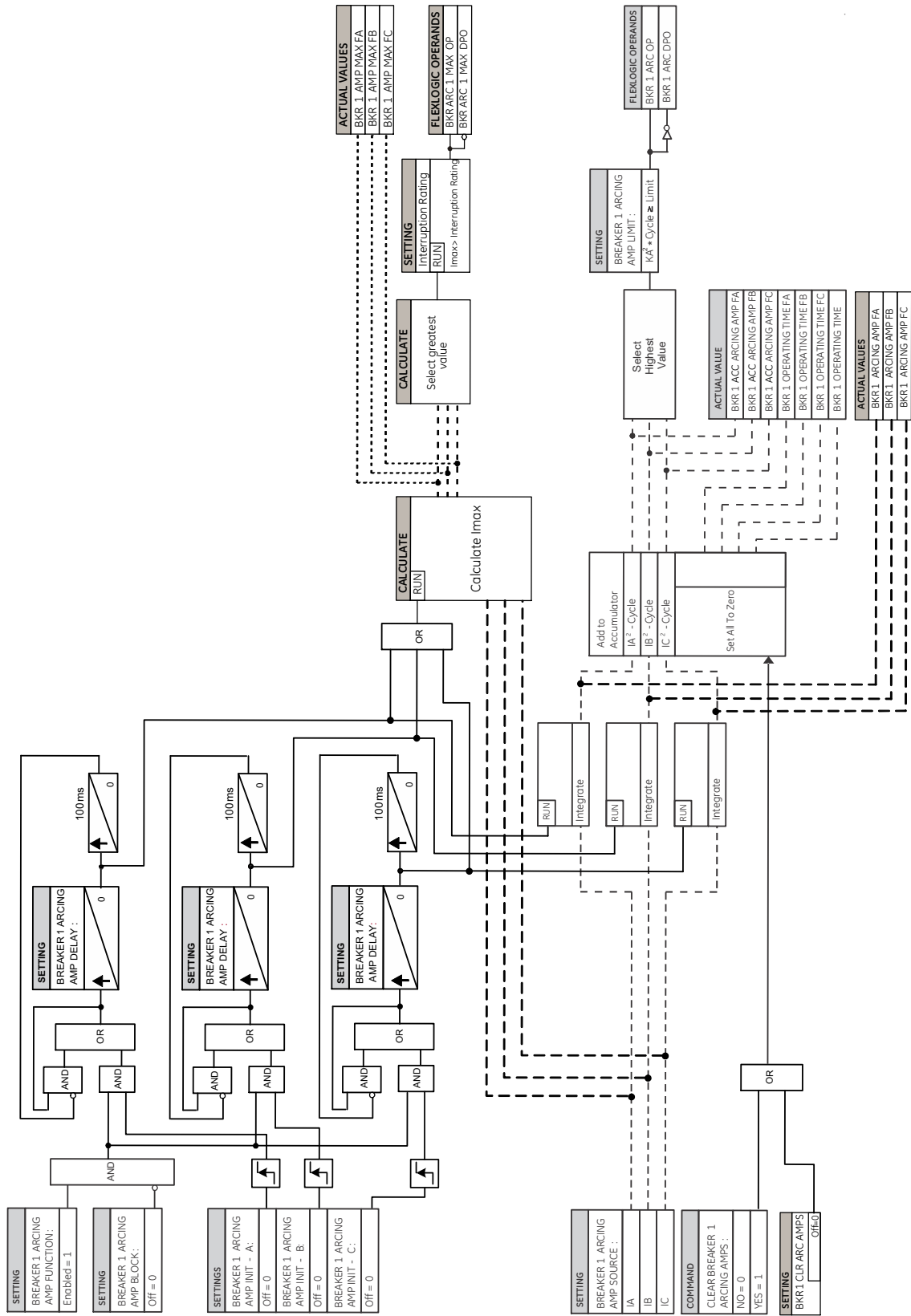


Figure 5-165: Breaker arcing current logic



82707ASCDR

### 5.8.12.3 CT failure detector

#### SETTINGS ⇌ CONTROL ELEMENTS ⇌ MONITORING ELEMENTS ⇌ CT FAILURE DETECTOR 1(4)

<div style="border: 1px solid black; padding: 2px;">           ■ CT FAILURE            ■ DETECTOR 1         </div>	↔	<div style="border: 1px solid black; padding: 2px;"> <b>CT FAIL 1 FUNCTION:</b>            Disabled         </div>	Range: Disabled, Enabled
	↕	<div style="border: 1px solid black; padding: 2px;"> <b>CT FAIL 1 BLOCK:</b>            Off         </div>	Range: FlexLogic operand
	↕	<div style="border: 1px solid black; padding: 2px;"> <b>CT FAIL 1 3I0 INP 1:</b>            SRC 1         </div>	Range: SRC 1, SRC 2, SRC 3, SRC 4
	↕	<div style="border: 1px solid black; padding: 2px;"> <b>CT FAIL 1 3I0 INP 1</b>            PKP: 0.2 pu         </div>	Range: 0.1 to 2.0 pu in steps of 0.1
	↕	<div style="border: 1px solid black; padding: 2px;"> <b>CT FAIL 1 3I0 INP 2:</b>            SRC 2         </div>	Range: SRC 1, SRC 2, SRC 3, SRC 4
	↕	<div style="border: 1px solid black; padding: 2px;"> <b>CT FAIL 1 3I0 INP 2</b>            PKP: 0.2 pu         </div>	Range: 0.1 to 2.0 pu in steps of 0.1
	↕	<div style="border: 1px solid black; padding: 2px;"> <b>CT FAIL 1 3V0 INPUT:</b>            SRC 1         </div>	Range: SRC 1, SRC 2, SRC 3, SRC 4
	↕	<div style="border: 1px solid black; padding: 2px;"> <b>CT FAIL 1 3V0 INPUT</b>            PKP: 0.20 pu         </div>	Range: 0.04 to 2.00 pu in steps of 0.01
	↕	<div style="border: 1px solid black; padding: 2px;"> <b>CT FAIL 1 PICKUP</b>            DELAY: 1.000 s         </div>	Range: 0.000 to 65.535 s in steps of 0.001
	↕	<div style="border: 1px solid black; padding: 2px;"> <b>CT FAIL 1 TARGET:</b>            Self-reset         </div>	Range: Self-reset, Latched, Disabled
↕	<div style="border: 1px solid black; padding: 2px;"> <b>CT FAIL 1 EVENTS:</b>            Disabled         </div>	Range: Disabled, Enabled	

The CT failure function detects problems with system current transformers used to supply current to the relay. This logic detects the presence of a zero-sequence current at the supervised source of current without a simultaneous zero-sequence current at another source, zero-sequence voltage, or some protection element condition.

The CT failure logic (see later) is based on the presence of the zero-sequence current in the supervised CT source and the absence of one of three or all of the three following conditions:

- Zero-sequence current at different source current (can be different set of CTs or different CT core of the same CT)
- Zero-sequence voltage at the assigned source
- Appropriate protection element or remote signal

Settings are described as follows.

**CT FAIL 1 FUNCTION** — Enables or disables operation of the CT failure element.

**CT FAIL 1 BLOCK** — Selects a FlexLogic operand to block operation of the element during some condition (for example, an open pole in process of the single pole tripping-reclosing). Local signals or remote signals representing operation of some remote current protection elements via communication channels can also be chosen.

**CT FAIL 1 3I0 INPUT 1** — Selects the current source for input 1. The most critical protection element should also be assigned to the same source.

**CT FAIL 1 3I0 INPUT 1 PICKUP** — Selects the 3I\_0 pickup value for input 1 (the main supervised CT source).

**CT FAIL 1 3I0 INPUT 2** — Selects the current source for input 2. Input 2 should use a different set of CTs or a different CT core of the same CT. If 3I\_0 does not exist at source 2, then a CT failure is declared.

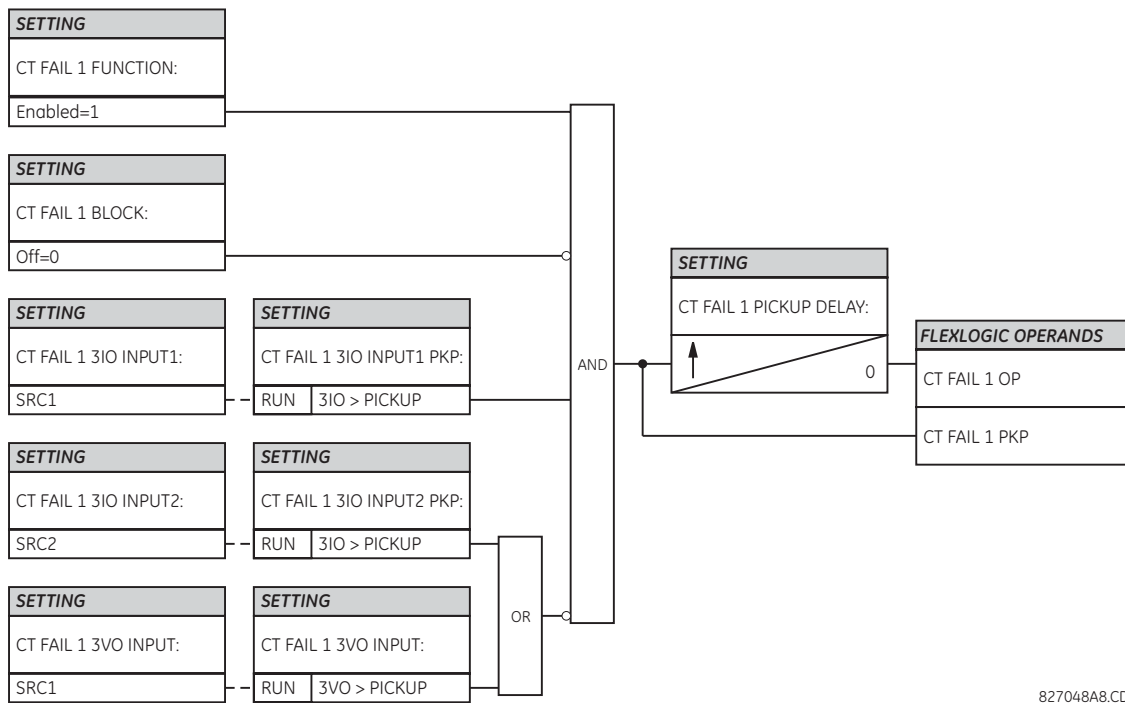
**CT FAIL 1 3I0 INPUT 2 PICKUP** — Selects the 3I\_0 pickup value for input 2 (different CT input) of the relay.

**CT FAIL 1 3V0 INPUT** — Selects the voltage source.

**CT FAIL 1 3V0 INPUT PICKUP** — Specifies the pickup value for the 3V\_0 source.

**CT FAIL 1 PICKUP DELAY** — Specifies the pickup delay of the CT failure element.

Figure 5-166: CT failure detector logic



827048A8.CDR

### 5.8.12.4 VT fuse failure

#### SETTINGS ⇌ CONTROL ELEMENTS ⇌ MONITORING ELEMENTS ⇌ VT FUSE FAILURE 1(4)

■ VT FUSE FAILURE 1	↔	VT FUSE FAILURE 1 FUNCTION: Disabled	Range: Disabled, Enabled
■	↕	VT FUSE FAILURE 1 ALARM DELAY: 1.000 s	Range: 0.000 to 65.535 s in steps of 0.001
	↕	NEUTRAL WIRE OPEN 1 DETECTION: Disabled	Range: Disabled, Enabled
	↑	NEUTRAL WIRE OPEN 1 3 HARM PKP: 0.100 pu	Range: 0.004 to 3.000 pu in steps of 0.001

Every signal source includes a fuse failure scheme.

The VT fuse failure detector is used to raise an alarm and/or block elements that operate incorrectly for a full or partial loss of AC potential caused by one or more blown fuses. Some elements that can be blocked (via the BLOCK input) are distance, voltage restrained overcurrent, and directional current.

There are two classes of fuse failure that occur:

- Class A — Loss of one or two phases
- Class B — Loss of all three phases

Different means of detection are required for each class. An indication of class A failures is a significant level of negative-sequence voltage, whereas an indication of class B failures is when positive sequence current is present and there is an insignificant amount of positive sequence voltage. Also, a rapid decrease in the phase voltages magnitude from a healthy voltage level without disturbance in current can indicate VT fuse fail conditions. These noted indications of fuse failure can also be present when faults are present on the system, so a means of detecting faults and inhibiting fuse failure declarations during these events is provided.

Once the fuse failure condition is declared, it is sealed-in until the cause that generated it disappears.

An additional condition is introduced to inhibit a fuse failure declaration when the monitored circuit is de-energized; positive-sequence voltage and current are both below threshold levels.

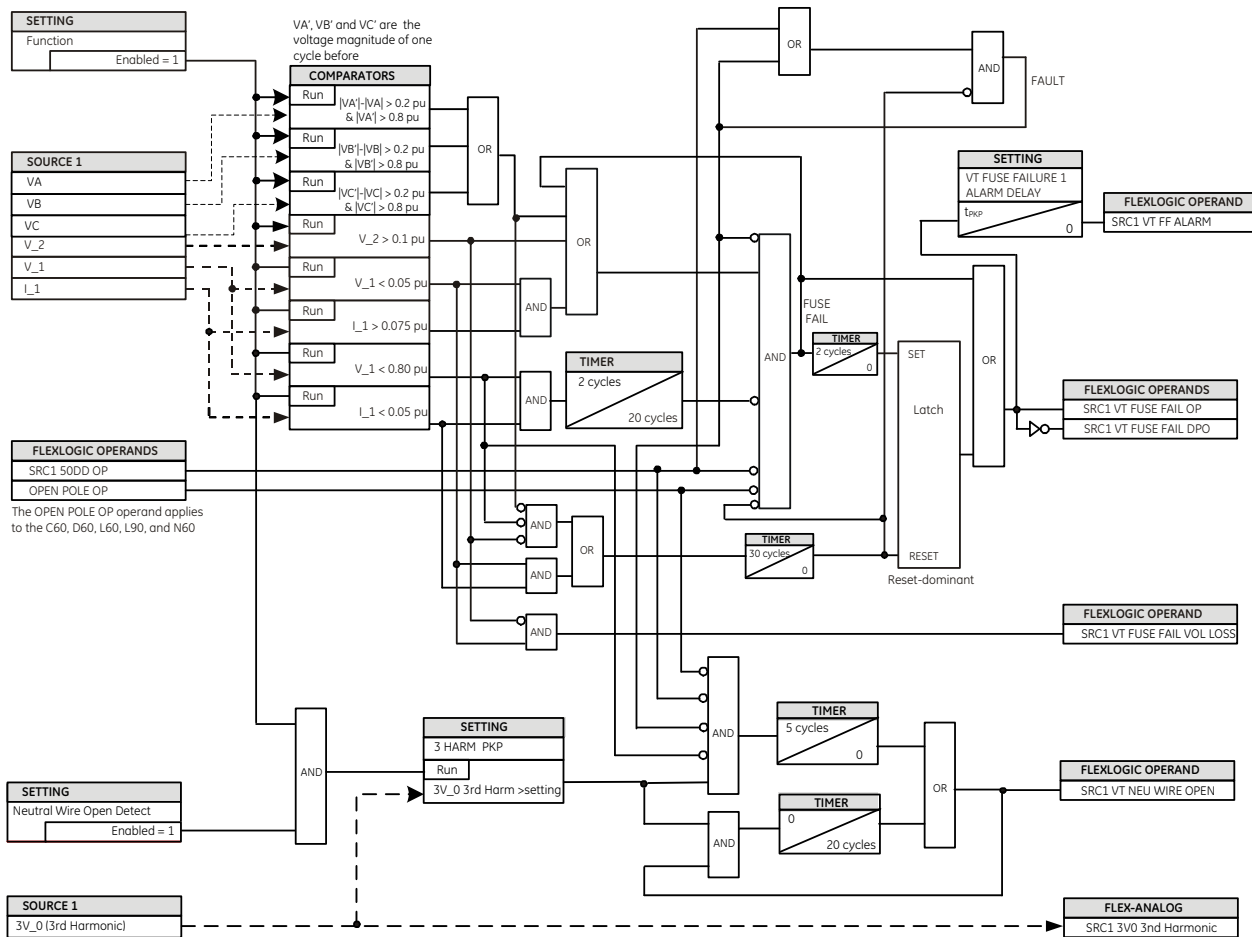
**VT FUSE FAILURE 1 FUNCTION** — Enables and disables the fuse failure feature for Source 1 VT Fuse Fail.

**NEUTRAL WIRE OPEN 1 DETECTION** — Enables and disables the VT neutral wire open detection function. When the VT is connected in Delta, do not enable this function because there is no neutral wire for Delta connected VT.

**NEUTRAL WIRE OPEN 1 3 HARM PKP** — Specifies the pickup level of 3rd harmonic of 3V0 signal for the **NEUTRAL WIRE OPEN DETECTION** logic to pick up.

Base voltage for this element is **PHASE VT SECONDARY** setting in the case of WYE VTs and  $(\text{PHASE VT SECONDARY}) / \sqrt{3}$  in case of DELTA VTs. The setting is found under **SETTINGS** ⇒ **⇓ SYSTEM SETUP** ⇒ **AC INPUTS** ⇒ **⇓ VOLTAGE BANK** ⇒ **PHASE VT SECONDARY**.

Figure 5-167: VT fuse fail logic



842235A1.vsd

### 5.8.12.5 Thermal overload protection (ANSI 49)

**SETTINGS** ⇒ **⇓ CONTROL ELEMENTS** ⇒ **⇓ MONITORING ELEMENTS** ⇒ **⇓ THERMAL OVERLOAD PROTECTION** ⇒ **⇓ THERMAL PROTECTION 1(2)**

■ THERMAL PROTECTION 1



THERMAL PROTECTION 1 FUNCTION: Disabled

Range: Disabled, Enabled



THERMAL PROTECTION 1 SOURCE: SRC1

Range: SRC 1, SRC 2, SRC 3, SRC 4

↕	<b>THERMAL PROTECTION 1 BASE CURR: 0.80 pu</b>	Range: 0.20 to 3.00 pu in steps of 0.01
↕	<b>THERMAL PROTECTION 1 k FACTOR: 1.10</b>	Range: 1.00 to 1.20 in steps of 0.05
↕	<b>THERM PROT 1 TRIP TIME CONST: 45 min</b>	Range: 0 to 1000 min. in steps of 1
↕	<b>THERM PROT 1 RESET TIME CONST: 45 min</b>	Range: 0 to 1000 min. in steps of 1
↕	<b>THERM PROT 1 MINIM RESET TIME: 20 min</b>	Range: 0 to 1000 min. in steps of 1
↕	<b>THERM PROT 1 RESET: Off</b>	Range: FlexLogic operand
↕	<b>THERM PROT 1 BLOCK: Off</b>	Range: FlexLogic operand
↕	<b>THERMAL PROTECTION 1 TARGET: Self-reset</b>	Range: Self-reset, Latched, Disabled
↑	<b>THERMAL PROTECTION 1 EVENTS: Disabled</b>	Range: Disabled, Enabled

The thermal overload protection element corresponds to the IEC 255-8 standard and is used to detect thermal overload conditions in protected power system elements. Choosing an appropriate time constant element can be used to protect different elements of the power system. The cold curve characteristic is applied when the estimated  $I_p$  current is less than 10% of the base current. If  $I_p$  current is greater or equal than 10% than the base current, then the hot curve characteristic is applied.  $I_p$  current is estimated with a fixed time constant for both cooling and heating that reaches to the final value in two seconds on a step change (either step up or step down) signal.

The IEC255-8 cold curve is defined as follows:

$$t_{op} = \tau_{op} \times \ln\left(\frac{I^2}{I^2 - (k \times I_B)^2}\right) \quad \text{Eq. 5-61}$$

The IEC255-8 hot curve is defined as follows:

$$t_{op} = \tau_{op} \times \ln\left(\frac{I^2 - I_p^2}{I^2 - (k \times I_B)^2}\right) \quad \text{Eq. 5-62}$$

where

$t_{op}$  = time to operate

$\tau_{op}$  = thermal protection trip time constant

$I$  = measured overload RMS current

$I_p$  = measured load RMS current before overload occurs

$k$  = IEC 255-8 k-factor applied to  $I_B$ , defining maximum permissible current above nominal current

$I_B$  = protected element base (nominal) current

To ensure element accuracy for high overcurrent conditions, the maximum value of  $I/(k \times I_B)$  is limited to 8, even when realistically it is exceeding this value.

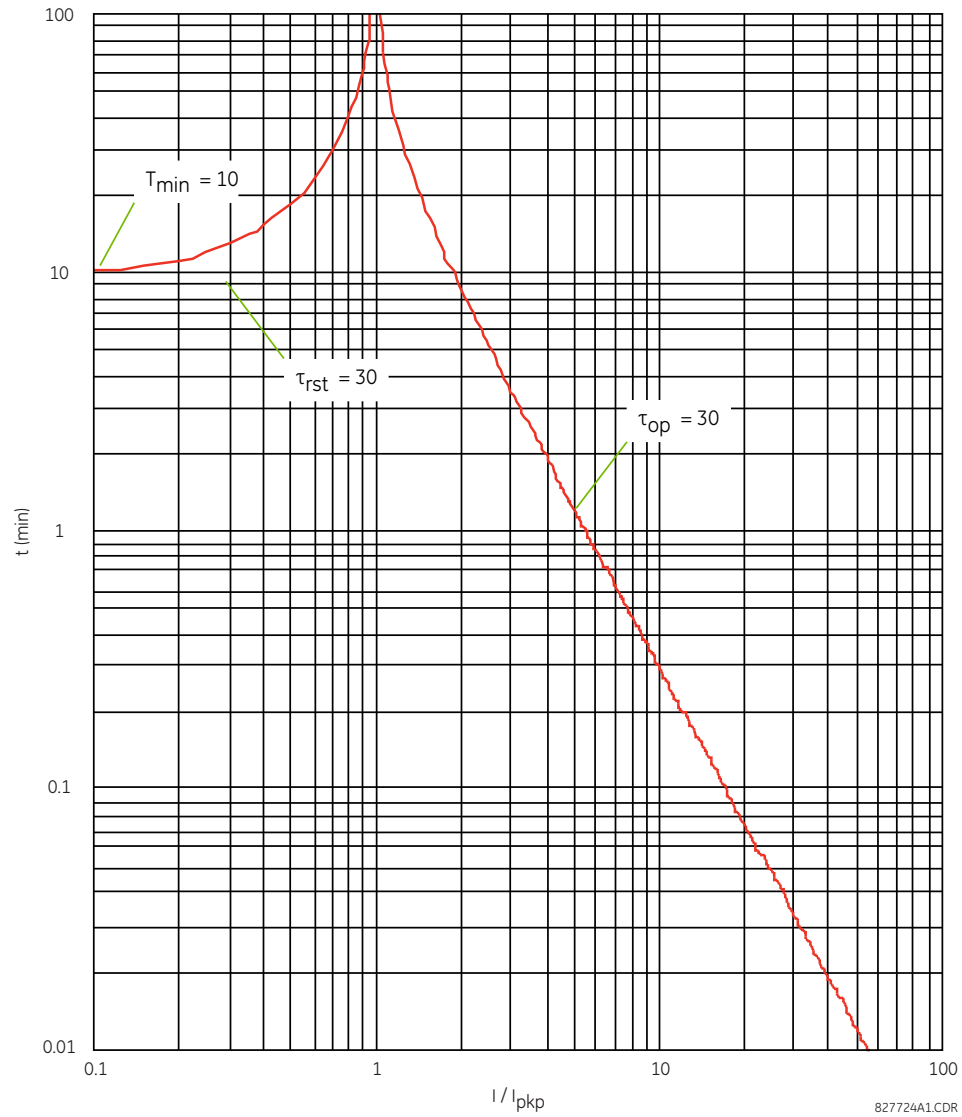
The reset time of the thermal overload protection element is also time delayed using following formula:

$$t_{rst} = \tau_{rst} \times \ln\left(\frac{(k \times I_B)^2}{|I^2 - (k \times I_B)^2|}\right) + T_{min} \quad \text{Eq. 5-63}$$

where

$\tau_{rst}$  = thermal protection trip time constant  
 $T_{min}$  = a minimum reset time setting

Figure 5-168: IEC 255-8 sample operate and reset curves



5

The thermal overload protection element estimates accumulated thermal energy  $E$  using the following equations calculated each power cycle. When current is greater than the pickup level,  $I_n > k \times I_B$ , element starts increasing the thermal energy:

$$E_n = E_{n-1} + \frac{\Delta t}{t_{op}(I_n)} \tag{Eq. 5-64}$$

When current is less than the dropout level,  $I_n > 0.97 \times k \times I_B$ , the element starts decreasing the thermal energy:

$$E_n = E_{n-1} - \frac{\Delta t}{t_{rst}(I_n)} \tag{Eq. 5-65}$$

where



$\Delta t$  is the power cycle duration  
 $n$  is the power cycle index  
 $t_{op(n)}$  is the trip time calculated at index  $n$  as per the IEC255-8 cold curve or hot curve equations  
 $t_{rst(n)}$  is the reset time calculated at index  $n$  as per the reset time equation  
 $I_n$  is the measured overload RMS current at index  $n$   
 $E_n$  is the accumulated energy at index  $n$   
 $E_{n-1}$  is the accumulated energy at index  $n - 1$

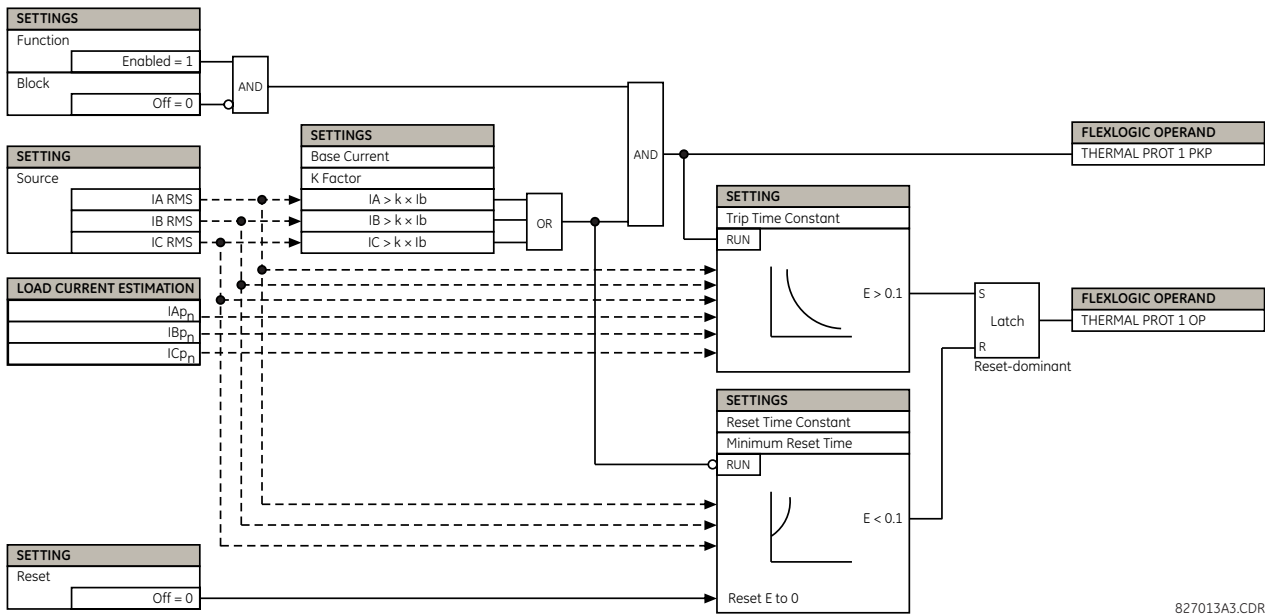
The thermal overload protection element removes the **THERMAL PROT 1 OP** output operand when  $E < 0.05$ . In case of emergency, the thermal memory and **THERMAL PROT 1 OP** output operand can be reset using **THERM PROT 1 RESET** setting. All calculations are performed per phase. If the accumulated energy reaches value 1 in any phase, the thermal overload protection element operates and only resets when energy is less than 0.05 in all three phases.

Table 5-39: Typical time constants

Protected equipment	Time constant	Minimum reset time
Capacitor bank	10 minutes	30 minutes
Overhead line	10 minutes	20 minutes
Air-core reactor	40 minutes	30 minutes
Busbar	60 minutes	20 minutes
Underground cable	20 to 60 minutes	60 minutes

The figure shows the logic for the thermal overload protection element.

Figure 5-169: Thermal overload protection logic

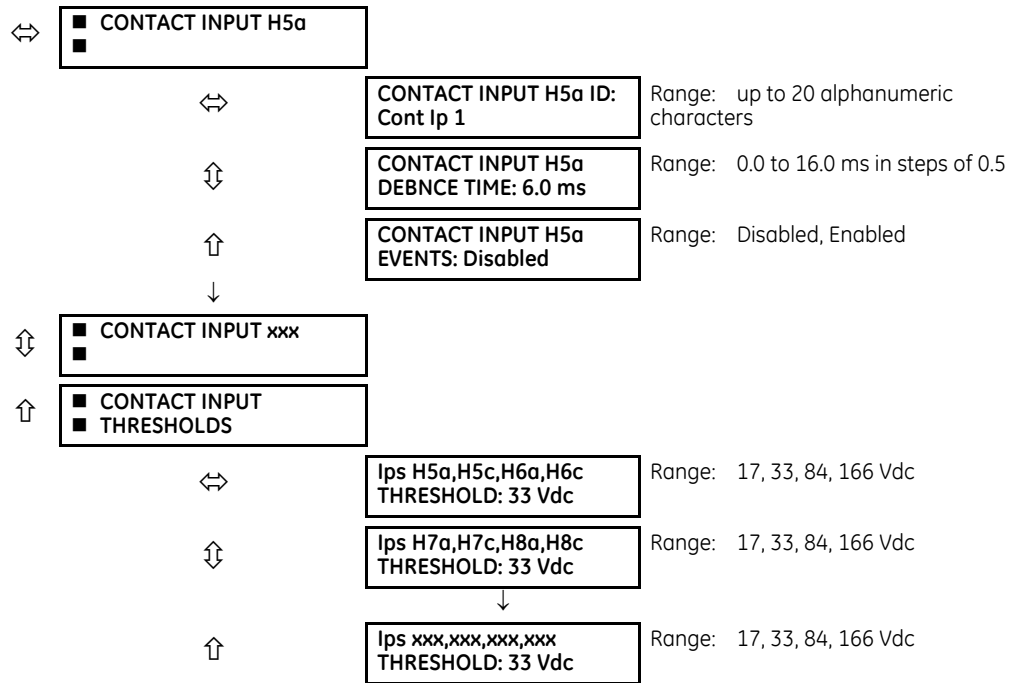


## 5.9 Inputs/outputs

### 5.9.1 Contact inputs

SETTINGS ⇌ INPUTS/OUTPUTS ⇌ CONTACT INPUTS

- CONTACT INPUTS
-



A contact inputs and outputs are digital signals associated with connections to hard-wired contacts. Wet and dry contacts are supported.

5

The contact inputs menu contains configuration settings for each contact input as well as voltage thresholds for each group of four contact inputs. Upon startup, the relay processor determines (from an assessment of the installed modules) which contact inputs are available and then display settings for only those inputs.

An alphanumeric ID can be assigned to a contact input for diagnostic, setting, and event recording purposes. The **CONTACT IP X On** (Logic 1) FlexLogic operand corresponds to contact input “X” being closed, while **CONTACT IP X Off** corresponds to contact input “X” being open. The **CONTACT INPUT DEBNCE TIME** defines the time required for the contact to overcome ‘contact bouncing’ conditions. As this time differs for different contact types and manufacturers, set it as a maximum contact debounce time (per manufacturer specifications) plus some margin to ensure proper operation. If **CONTACT INPUT EVENTS** is set to “Enabled,” every change in the contact input state triggers an event.

A raw status is scanned for all Contact Inputs synchronously at the constant rate of 0.5 ms as shown in the following figure. The DC input voltage is compared to a user-settable threshold. A new contact input state must be maintained for a user-settable debounce time in order for the G30 to validate the new contact state. In the following figure, the debounce time is set at 2.5 ms; thus the 6th sample in a row validates the change of state (mark no. 1 in the diagram). Once validated (de-bounced), the contact input asserts a corresponding FlexLogic operand and logs an event as per user setting.

A time stamp of the first sample in the sequence that validates the new state is used when logging the change of the contact input into the Event Recorder (mark no. 2 in the figure).

Protection and control elements, as well as FlexLogic equations and timers, are executed eight times in a power system cycle. The protection pass duration is controlled by the frequency tracking mechanism. The FlexLogic operand reflecting the debounced state of the contact is updated at the protection pass following the validation (marks no. 3 and 4 on the figure that follows). The update is performed at the beginning of the protection pass so all protection and control functions, as well as FlexLogic equations, are fed with the updated states of the contact inputs.

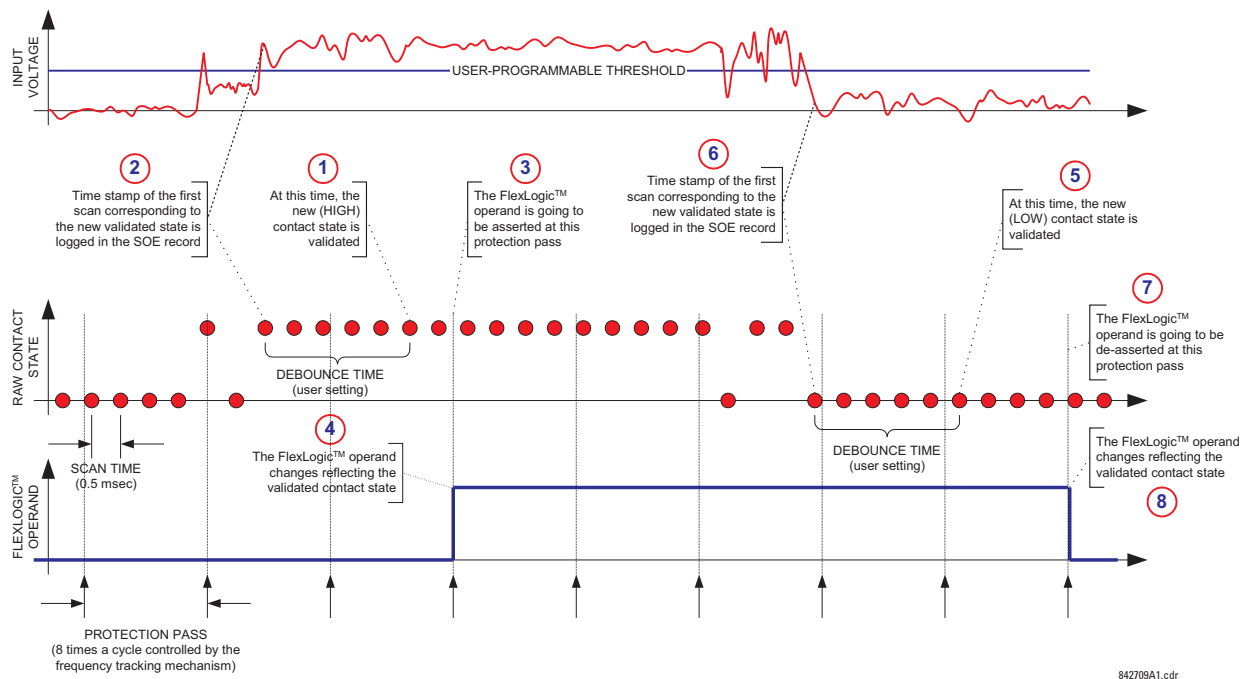
The FlexLogic operand response time to the contact input change is equal to the debounce time setting plus up to one protection pass (variable and depending on system frequency if frequency tracking enabled). If the change of state occurs just after a protection pass, the recognition is delayed until the subsequent protection pass; that is, by the entire duration of the protection pass. If the change occurs just prior to a protection pass, the state is recognized immediately. Statistically a delay of half the protection pass is expected. Owing to the 0.5 ms scan rate, the time resolution for the input contact is below 1 ms.

For example, eight protection passes per cycle on a 60 Hz system correspond to a protection pass every 2.1 ms. With a contact debounce time setting of 3.0 ms, the FlexLogic operand-assert time limits are:  $3.0 + 0.0 = 3.0$  ms and  $3.0 + 2.1 = 5.1$  ms. These time limits depend on how soon the protection pass runs after the debouncing time.

Regardless of the contact debounce time setting, the contact input event is time-stamped with a 1 μs accuracy using the time of the first scan corresponding to the new state (mark no. 2 shown). Therefore, the time stamp reflects a change in the DC voltage across the contact input terminals that was not accidental as it was subsequently validated using the debounce timer. Keep in mind that the associated FlexLogic operand is asserted/de-asserted later, after validating the change.

The debounce algorithm is symmetrical: the same procedure and debounce time are used to filter the LOW-HIGH (marks no.1, 2, 3, and 4 in the figure) and HIGH-LOW (marks no. 5, 6, 7, and 8) transitions.

Figure 5-170: Input contact debouncing mechanism and time stamp sample timing



Contact inputs are isolated in groups of four to allow connection of wet contacts from different voltage sources for each group. The **CONTACT INPUT THRESHOLDS** determine the minimum voltage required to detect a closed contact input. This value is selected according to the following criteria: 17 for 24 V sources, 33 for 48 V sources, 84 for 110 to 125 V sources and 166 for 250 V sources.

For example, to use contact input H5a as a status input from the breaker 52b contact to seal-in the trip relay and record it in the Event Records menu, make the following settings changes:

- CONTACT INPUT H5a ID: "Breaker Closed (52b)"
- CONTACT INPUT H5a EVENTS: "Enabled"

Note that the 52b contact is closed when the breaker is open and open when the breaker is closed.

### 5.9.2 Virtual inputs

SETTINGS ⇒ INPUTS/OUTPUTS ⇒ VIRTUAL INPUTS ⇒ VIRTUAL INPUT 1(64)

<div style="border: 1px solid black; padding: 2px;"> <span style="display: inline-block; width: 10px; height: 10px; background-color: black; margin-right: 5px;"></span> VIRTUAL INPUT 1                 </div>	↔	<div style="border: 1px solid black; padding: 2px;">                     VIRTUAL INPUT 1                      FUNCTION: Disabled                 </div>	Range: Disabled, Enabled
---	---	---	--------------------------

⇅	VIRTUAL INPUT 1 ID: Virt Ip 1	Range: up to 20 alphanumeric characters
⇅	VIRTUAL INPUT 1 TYPE: Latched	Range: Self-Reset, Latched
↑	VIRTUAL INPUT 1 EVENTS: Disabled	Range: Disabled, Enabled

The virtual inputs and outputs are digital signals associated with UR-series internal logic signals. Virtual inputs include signals generated by the local user interface. The virtual outputs are outputs of FlexLogic equations used to customize the device. Virtual outputs can also serve as virtual inputs to FlexLogic equations.

There are 64 virtual inputs that can be individually programmed to respond to input signals from the keypad (via the **COMMANDS** menu) and communications protocols. All virtual input operands are defaulted to “Off” (logic 0) unless the appropriate input signal is received.

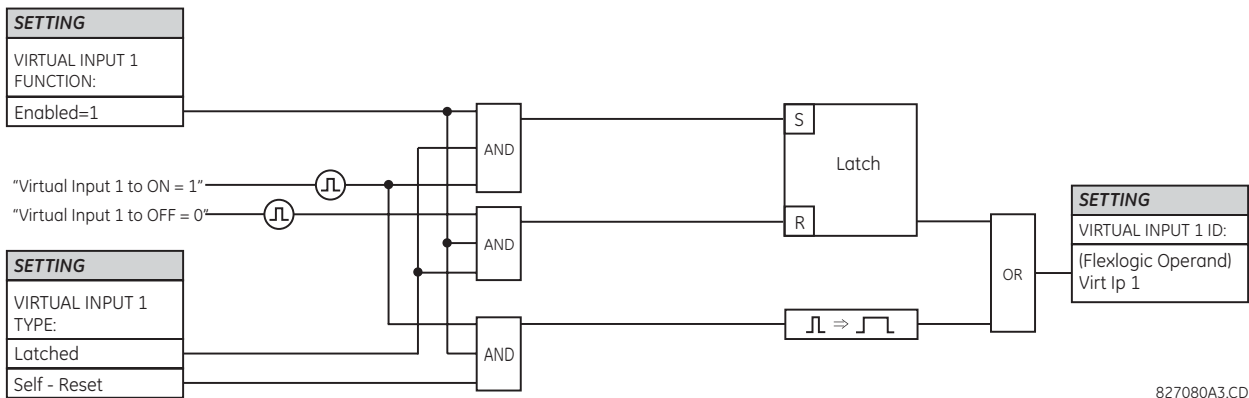
If the **VIRTUAL INPUT x FUNCTION** is “Disabled,” the input is forced to off (logic 0) regardless of any attempt to alter the input. If set to “Enabled,” the input operates as shown on the logic diagram and generates output FlexLogic operands in response to received input signals and the applied settings.

There are two types of operation: self-reset and latched. If **VIRTUAL INPUT x type** is “Self-Reset,” when the input signal transits from off to on, the output operand is set to on for only one evaluation of the FlexLogic equations and then return to off. If set to “Latched,” the virtual input sets the state of the output operand to the same state as the most recent received input.

The self-reset operating mode generates the output operand for a single evaluation of the FlexLogic equations. If the operand is to be used anywhere other than internally in a FlexLogic equation, it likely needs to be lengthened in time. A FlexLogic timer with a delayed reset can perform this function.

5

Figure 5-171: Virtual inputs logic



827080A3.CDR

### 5.9.3 Contact outputs

#### 5.9.3.1 Digital outputs

SETTINGS ⇅ INPUTS/OUTPUTS ⇅ CONTACT OUTPUTS ⇅ CONTACT OUTPUT H1

■ CONTACT OUTPUT H1	⇅	CONTACT OUTPUT H1 ID Cont Op 1	Range: up to 20 alphanumeric characters
	⇅	OUTPUT H1 OPERATE: Off	Range: FlexLogic operand
	⇅	OUTPUT H1 SEAL-IN: Off	Range: FlexLogic operand
	↑	CONTACT OUTPUT H1 EVENTS: Enabled	Range: Disabled, Enabled

A contact inputs and outputs are digital signals associated with connections to hard-wired contacts. Wet and dry contacts are supported.

Upon startup of the relay, the main processor determines from an assessment of the modules installed in the chassis which contact outputs are available and then presents the settings for only these outputs. Where the contact input is non-latching, the settings are as shown.

An ID can be assigned to each contact output. The signal that can OPERATE a contact output can be any FlexLogic operand (virtual output, element state, contact input, or virtual input). An additional FlexLogic operand can be used to SEAL-IN the relay. Any change of state of a contact output can be logged as an Event if programmed to do so.

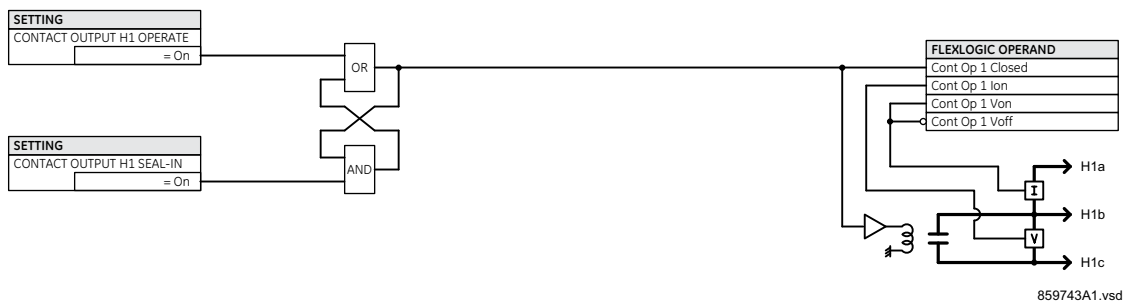
For example, the trip circuit current is monitored by providing a current threshold detector in series with some Form-A contacts (see the trip circuit example in the Digital Elements section). The monitor sets a flag (see the specifications for Form-A). The name of the FlexLogic operand set by the monitor, consists of the output relay designation, followed by the name of the flag; for example, *Cont OP 1 IO<sub>n</sub>*.

In most breaker control circuits, the trip coil is connected in series with a breaker auxiliary contact used to interrupt current flow after the breaker has tripped, to prevent damage to the less robust initiating contact. This can be done by monitoring an auxiliary contact on the breaker which opens when the breaker has tripped, but this scheme is subject to incorrect operation caused by differences in timing between breaker auxiliary contact change-of-state and interruption of current in the trip circuit. The most dependable protection of the initiating contact is provided by directly measuring current in the tripping circuit, and using this parameter to control resetting of the initiating relay. This scheme is often called trip seal-in.

This can be realized using the *Cont OP 1 IO<sub>n</sub>* FlexLogic operand to seal-in the contact output as follows:

- CONTACT OUTPUT H1 ID:** "Cont Op 1"
- OUTPUT H1 OPERATE:** any suitable FlexLogic operand
- OUTPUT H1 SEAL-IN:** "Cont Op 1 IO<sub>n</sub>"
- CONTACT OUTPUT H1 EVENTS:** "Enabled"

Figure 5-172: Contact input/output module type 6A contact 1 logic



### 5.9.3.2 Latching outputs

SETTINGS ⇄ INPUTS/OUTPUTS ⇄ CONTACT OUTPUTS ⇒ CONTACT OUTPUT H1a

■ CONTACT OUTPUT H1a	↔	OUTPUT H1a ID L-Cont Op 1	Range: up to 20 alphanumeric characters
	↕	OUTPUT H1a OPERATE: Off	Range: FlexLogic operand
	↕	OUTPUT H1a RESET: Off	Range: FlexLogic operand
	↕	OUTPUT H1a TYPE: Operate-dominant	Range: Operate-dominant, Reset-dominant
	↑	OUTPUT H1a EVENTS: Disabled	Range: Disabled, Enabled

The latching output contacts are mechanically bi-stable and controlled by two separate (open and close) coils. As such they retain their position even if the relay is not powered up. The relay recognizes all latching output contact cards and populates the setting menu accordingly. On power up, the relay reads positions of the latching contacts from the hardware before executing any other functions of the relay (such as protection and control features or FlexLogic).

The latching output modules, either as part of the relay or as individual modules, are shipped from the factory with all latching contacts open. It is highly recommended to double-check the programming and positions of the latching contacts when replacing a module.

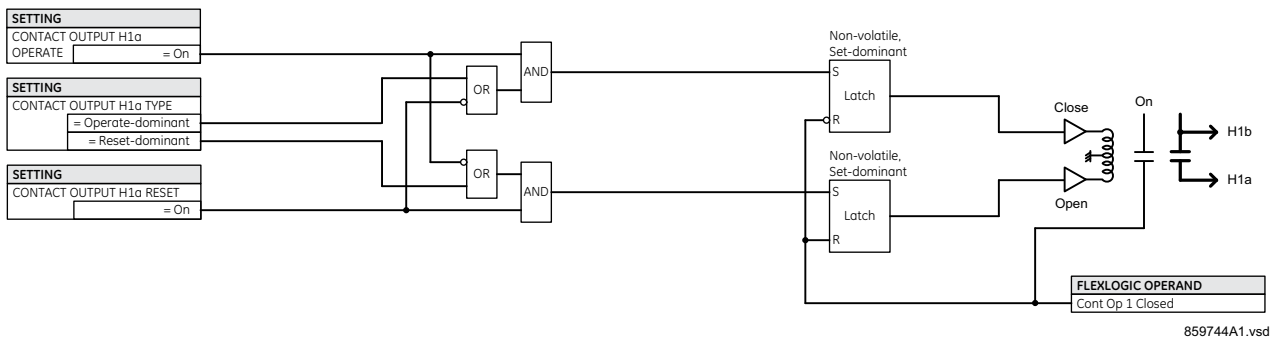
Since the relay asserts the output contact and reads back its position, it is possible to incorporate self-monitoring capabilities for the latching outputs. If any latching outputs exhibits a discrepancy, the LATCHING OUTPUT ERROR self-test error is declared. The error is signaled by the **LATCHING OUT ERROR** FlexLogic operand, event, and target message.

**OUTPUT H1a OPERATE** — This setting specifies a FlexLogic operand to operate the ‘close coil’ of the contact. The relay seals-in this input to safely close the contact. Once the contact is closed and the **RESET** input is logic 0 (off), any activity of the **OPERATE** input, such as subsequent chattering, does not have any effect. With both the **OPERATE** and **RESET** inputs active (logic 1), the response of the latching contact is specified by the **OUTPUT H1a TYPE** setting.

**OUTPUT H1a RESET** — This setting specifies a FlexLogic operand to operate the ‘trip coil’ of the contact. The relay seals-in this input to safely open the contact. Once the contact is opened and the **OPERATE** input is logic 0 (off), any activity of the **RESET** input, such as subsequent chattering, does not have any effect. With both the **OPERATE** and **RESET** inputs active (logic 1), the response of the latching contact is specified by the **OUTPUT H1a TYPE** setting.

**OUTPUT H1a TYPE** — This setting specifies the contact response under conflicting control inputs; that is, when both the **OPERATE** and **RESET** signals are applied. With both control inputs applied simultaneously, the contact closes if set to “Operate-dominant” and opens if set to “Reset-dominant.”

Figure 5-173: Contact input/output module type 4L contact 1 logic



### Application example 1

A latching output contact H1a is to be controlled from two user-programmable pushbuttons (buttons number 1 and 2). The following settings are applied.

Program the Latching Outputs by making the following changes in the **SETTINGS** ⇒ **INPUTS/OUTPUTS** ⇒ **CONTACT OUTPUTS** ⇒ **CONTACT OUTPUT H1a** menu (assuming an H4L module):

- OUTPUT H1a OPERATE:** “PUSHBUTTON 1 ON”
- OUTPUT H1a RESET:** “PUSHBUTTON 2 ON”

Program the pushbuttons by making the following changes in the **PRODUCT SETUP** ⇒ **USER-PROGRAMMABLE PUSHBUTTONS** ⇒ **USER PUSHBUTTON 1** and **USER PUSHBUTTON 2** menus:

- PUSHBUTTON 1 FUNCTION:** “Self-reset”
- PUSHBTN 1 DROP-OUT TIME:** “0.00 s”
- PUSHBUTTON 2 FUNCTION:** “Self-reset”
- PUSHBTN 2 DROP-OUT TIME:** “0.00 s”

### Application example 2

A relay, having two latching contacts H1a and H1c, is to be programmed. The H1a contact is to be a Type-a contact, while the H1c contact is to be a Type-b contact (Type-a means closed after exercising the operate input; Type-b means closed after exercising the reset input). The relay is to be controlled from virtual outputs: VO1 to operate and VO2 to reset.

Program the Latching Outputs by making the following changes in the **SETTINGS** ⇒ **INPUTS/OUTPUTS** ⇒ **CONTACT OUTPUTS** ⇒ **CONTACT OUTPUT H1a** and **CONTACT OUTPUT H1c** menus (assuming an H4L module):

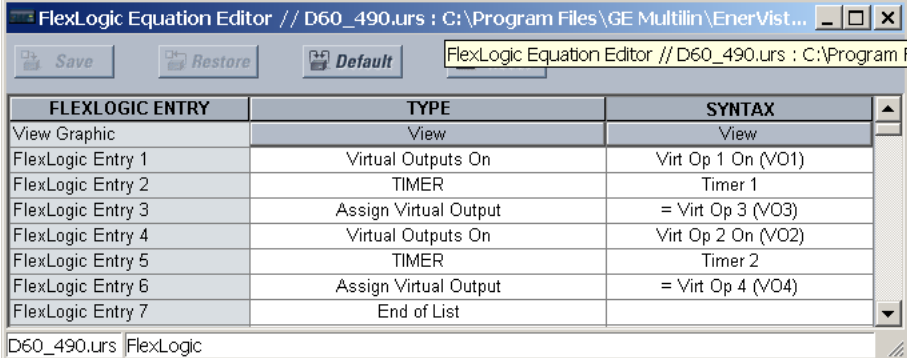
**OUTPUT H1a OPERATE:** "VO1"  
**OUTPUT H1a RESET:** "VO2"  
**OUTPUT H1c OPERATE:** "VO2"  
**OUTPUT H1c RESET:** "VO1"

Since the two physical contacts in this example are mechanically separated and have individual control inputs, they do not operate at exactly the same time. A discrepancy in the range of a fraction of a maximum operating time can occur. Therefore, a pair of contacts programmed to be a multi-contact relay do not guarantee any specific sequence of operation (such as make before break). If required, the sequence of operation must be programmed explicitly by delaying some of the control inputs as shown in the next application example.

### Application example 3

A make before break functionality must be added to the preceding example. An overlap of 20 ms is required to implement this functionality.

Write the following FlexLogic equation (EnerVista example shown).



FLEXLOGIC ENTRY	TYPE	SYNTAX
View Graphic	View	View
FlexLogic Entry 1	Virtual Outputs On	Virt Op 1 On (VO1)
FlexLogic Entry 2	TIMER	Timer 1
FlexLogic Entry 3	Assign Virtual Output	= Virt Op 3 (VO3)
FlexLogic Entry 4	Virtual Outputs On	Virt Op 2 On (VO2)
FlexLogic Entry 5	TIMER	Timer 2
FlexLogic Entry 6	Assign Virtual Output	= Virt Op 4 (VO4)
FlexLogic Entry 7	End of List	

Set both timers (Timer 1 and Timer 2) to 20 ms pickup and 0 ms dropout.

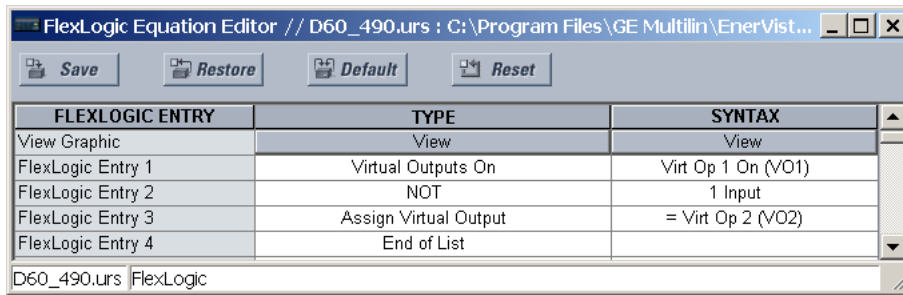
Program the Latching Outputs by making the following changes in the **SETTINGS** ⇒ **INPUTS/OUTPUTS** ⇒ **CONTACT OUTPUTS** ⇒ **CONTACT OUTPUT H1a** and **CONTACT OUTPUT H1c** menus (assuming an H4L module):

**OUTPUT H1a OPERATE:** "VO1"  
**OUTPUT H1a RESET:** "VO4"  
**OUTPUT H1c OPERATE:** "VO2"  
**OUTPUT H1c RESET:** "VO3"

### Application example 4

A latching contact H1a is to be controlled from a single virtual output VO1. The contact is to remain closed as long as VO1 is high, and is to remain opened when VO1 is low. Program the relay as follows.

Write the following FlexLogic equation (EnerVista example shown).



Program the Latching Outputs by making the following changes in the **SETTINGS** ⇒ **INPUTS/OUTPUTS** ⇒ **CONTACT OUTPUTS** ⇒ **CONTACT OUTPUT H1a** menu (assuming an H4L module):

- OUTPUT H1a OPERATE: "VO1"
- OUTPUT H1a RESET: "VO2"

### 5.9.4 Virtual outputs

SETTINGS ⇒ INPUTS/OUTPUTS ⇒ VIRTUAL OUTPUTS ⇒ VIRTUAL OUTPUT 1(96)

VIRTUAL OUTPUT 1

↔

VIRTUAL OUTPUT 1 ID  
Virt Op 1

Range: up to 20 alphanumeric characters

↑

VIRTUAL OUTPUT 1  
EVENTS: Disabled

Range: Disabled, Enabled

The virtual inputs and outputs are digital signals associated with UR-series internal logic signals. Virtual inputs include signals generated by the local user interface. The virtual outputs are outputs of FlexLogic equations used to customize the device. Virtual outputs can also serve as virtual inputs to FlexLogic equations.

There are 96 virtual outputs that can be assigned using FlexLogic. If not assigned, the output is forced to 'OFF' (Logic 0). An ID also can be assigned to each virtual output. Virtual outputs are resolved in each pass through the evaluation of the FlexLogic equations. Any change of state of a virtual output can be logged as an event if programmed to do so.

For example, if Virtual Output 1 is the trip signal from FlexLogic and the trip relay is used to signal events, the settings is programmed as follows:

- VIRTUAL OUTPUT 1 ID: "Trip"
- VIRTUAL OUTPUT 1 EVENTS: "Disabled"

### 5.9.5 Resetting

#### 5.9.5.1 Enhanced and basic front panels

SETTINGS ⇒ INPUTS/OUTPUTS ⇒ RESETTING

RESETTING

↔

RESET OPERAND:  
Off

Range: FlexLogic operand

#### 5.9.5.2 Graphical front panel

SETTINGS ⇒ INPUTS/OUTPUTS ⇒ RESETTING

RESETTING

↔

RESET OPERAND:  
Off

Range: FlexLogic operand

↑

RESET ANNUNCIATOR:  
Off

Range: FlexLogic operand



Some events can be programmed to latch the front panel LED event indicators, target messages, and/or graphical front panel annunciator windows. Once set, the latching mechanism holds the latched indicators, messages, or windows in the set state after the initiating condition has cleared until a **RESET** command is received to return these latches (not including FlexLogic latches) to the reset state where the initiating condition has cleared. The **RESET** command can be sent from the front panel **RESET** button, a remote device via a communications channel, or any selected operand. The Modbus execute function 05h with operation code 1 command is also available to perform the same function as the front panel **RESET** key.

**RESET OPERAND** — The three sources of **RESET** commands each activates the **RESET OP** FlexLogic operand. Each individual source of a **RESET** command also activates its individual operand **RESET OP (PUSHBUTTON)**, **RESET OP (COMMS)**, or **RESET OP (OPERAND)** to identify the source of the command. Each of these three operands generates an event in the event record when activated. The **RESET OPERAND** setting here selects the operand that activates the **RESET OP (OPERAND)** operand.

**RESET ANNUNCIATOR** — Used to select a FlexLogic operand that when activated acknowledges/resets all annunciator windows on the graphical front panel. The other methods to acknowledge/reset annunciator windows include:

- On the displayed page, press the **RESET** pushbutton with none of the annunciator windows selected to acknowledge/reset all annunciator windows on that page
- To acknowledge/reset a specific annunciator window, use the Up, Down, Left and Right pushbuttons to select the window, and press the **RESET** or **ENTER** pushbutton
- All annunciator windows can be reset remotely by programming a Virtual Input (for example Virtual Input 1) as the input to the **RESET ANNUNCIATOR** setting. Then the Modbus execute function 05h with operation code 1000h command (or function 10h with address 400h) is used to set the state of Virtual Input 1.

For the **RESET ANNUNCIATOR** setting, the **RESET ANCTR OP** FlexLogic operand is activated by the two sources of **RESET** command, operand source and manual source. Each individual source of a **RESET ANNUNCIATOR** command also activates its individual operand **RESET OP (OPRD)** or **RESET ANCTR OP (MNUL)** to identify the source of the command. Each of these two operands generates an event in the event record when activated. The setting here selects the operand that activates the **RESET ANCTR OP (OPRD)** operand. The **RESET** pushbutton on the front panel or the reset command from the software activates the **RESET ANCTR OP (MNUL)** operand.

## 5.9.6 Direct inputs and outputs

### 5.9.6.1 Direct inputs

SETTINGS ⇌ INPUTS/OUTPUTS ⇌ DIRECT INPUTS ⇌ DIRECT INPUT 1(32)

■ DIRECT INPUT 1	↔	DIRECT INPUT 1 NAME: Dir Ip 1	Range: up to 12 alphanumeric characters
■	↕	DIRECT INPUT 1 DEVICE ID: 0	Range: 0 to 16
	↕	DIRECT INPUT 1 BIT NUMBER: 0	Range: 0 to 32
	↕	DIRECT INPUT 1 DEFAULT: Off	Range: On, Off, Latest/On, Latest/Off
	↑	DIRECT INPUT 1 EVENTS: Disabled	Range: Enabled, Disabled

These settings specify how the direct input information is processed.

**DIRECT INPUT 1 NAME** — This setting allows the user to assign a descriptive name to the direct input.

**DIRECT INPUT 1 DEVICE ID** — Represents the source of direct input 1. The specified direct input is driven by the device identified here.

**DIRECT INPUT 1 BIT NUMBER** — The bit number to extract the state for direct input 1. Direct Input 1 is driven by the bit identified as **DIRECT INPUT 1 BIT NUMBER**. This corresponds to the direct output number of the sending device.

**DIRECT INPUT 1 DEFAULT STATE** — Represents the state of the direct input when the associated direct device is offline. The following choices are available:

- On — Defaults the input to Logic 1

- Off — Defaults the input to Logic 0
- Latest/On — Freezes the input in case of lost communications. When the latest state is not known, such as after relay power-up but before the first communication exchange, the input defaults to Logic 1. When communication resumes, the input becomes fully operational.
- Latest/Off — Freezes the input in case of lost communications. When the latest state is not known, such as after relay power-up but before the first communication exchange, the input defaults to Logic 0. When communication resumes, the input becomes fully operational.

### 5.9.6.2 Direct outputs

SETTINGS ⇄ INPUTS/OUTPUTS ⇄ DIRECT OUTPUTS ⇄ DIRECT OUTPUT 1(32)

■ DIRECT OUTPUT 1 ■	↔	DIRECT OUT 1 NAME: Dir Out 1	Range: up to 12 alphanumeric characters
	⇅	DIRECT OUT 1 OPERAND: Off	Range: FlexLogic operand
	↑	DIRECT OUTPUT 1 EVENTS: Disabled	Range: Enabled, Disabled

**DIRECT OUT 1 NAME** — This setting allows the user to assign a descriptive name to the direct output.

**DIR OUT 1 OPERAND** — This sets the FlexLogic operand that determines the state of this direct output.

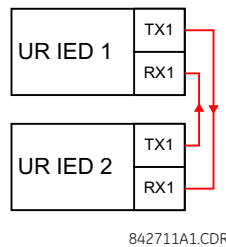
### 5.9.6.3 Application examples

The examples introduced in the earlier Direct Inputs and Outputs section (part of the Product Setup section) are continued here to illustrate usage of the direct inputs and outputs.

#### Example 1: Extending input/output capabilities of a UR relay

Consider an application that requires additional quantities of contact inputs or output contacts or lines of programmable logic that exceed the capabilities of a single UR-series chassis. The problem is solved by adding an extra UR-series IED, such as the C30, to satisfy the additional inputs/outputs and programmable logic requirements. The figure shows that two IEDs are connected via single-channel digital communication cards.

Figure 5-174: Input and output extension via direct inputs and outputs



Assume that contact input 1 from UR IED 2 is to be used by UR IED 1. The following settings are applied (Direct Input 5 and bit number 12 are used, as an example).

UR IED 1:

- DIRECT INPUT 5 DEVICE ID** = "2"
- DIRECT INPUT 5 BIT NUMBER** = "12"

UR IED 2:

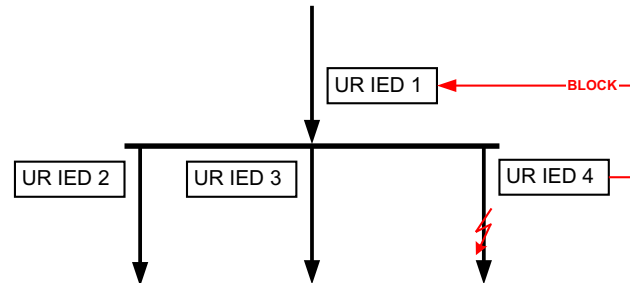
- DIRECT OUT 12 OPERAND** = "Cont I<sub>p</sub> 1 On"

The Cont I<sub>p</sub> 1 On operand of UR IED 2 is now available in UR IED 1 as **DIRECT INPUT 5 ON**.

### Example 2: Interlocking busbar protection

A simple interlocking busbar protection scheme can be accomplished by sending a blocking signal from downstream devices, say 2, 3 and 4, to the upstream device that monitors a single incomer of the busbar, as shown in the figure.

Figure 5-175: Sample interlocking busbar protection scheme



842712A1.CDR

Assume that Phase Instantaneous Overcurrent 1 is used by Devices 2, 3, and 4 to block Device 1. If not blocked, Device 1 trips the bus upon detecting a fault and applying a short coordination time delay.

The following settings are applied (assume Bit 3 is used by all 3 devices to send the blocking signal and Direct Inputs 7, 8, and 9 are used by the receiving device to monitor the three blocking signals).

UR IED 2:

**DIRECT OUT 3 OPERAND:** "PHASE IOC1 OP"

UR IED 3:

**DIRECT OUT 3 OPERAND:** "PHASE IOC1 OP"

UR IED 4:

**DIRECT OUT 3 OPERAND:** "PHASE IOC1 OP"

UR IED 1:

**DIRECT INPUT 7 DEVICE ID:** "2"

**DIRECT INPUT 7 BIT NUMBER:** "3"

**DIRECT INPUT 7 DEFAULT STATE:** select "On" for security, select "Off" for dependability

**DIRECT INPUT 8 DEVICE ID:** "3"

**DIRECT INPUT 8 BIT NUMBER:** "3"

**DIRECT INPUT 8 DEFAULT STATE:** select "On" for security, select "Off" for dependability

**DIRECT INPUT 9 DEVICE ID:** "4"

**DIRECT INPUT 9 BIT NUMBER:** "3"

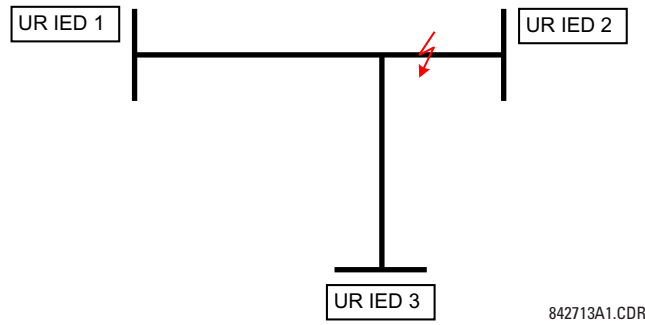
**DIRECT INPUT 9 DEFAULT STATE:** select "On" for security, select "Off" for dependability

Now the three blocking signals are available in UR IED 1 as **DIRECT INPUT 7 ON**, **DIRECT INPUT 8 ON**, and **DIRECT INPUT 9 ON**. Upon losing communications or a device, the scheme is inclined to block (if any default state is set to "On"), or to trip the bus on any overcurrent condition (all default states set to "Off").

### Example 3: Pilot-aided schemes

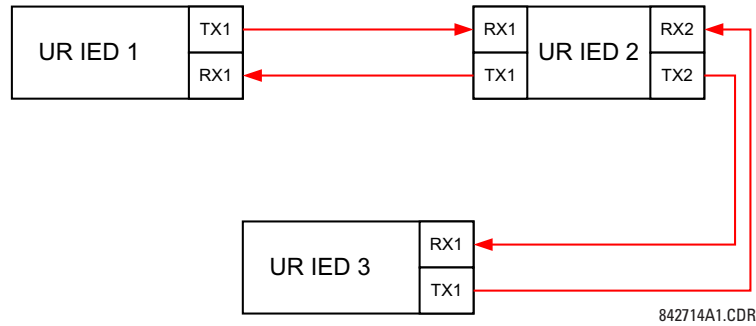
Consider a three-terminal line protection application shown in the following figure.

Figure 5-176: Three-terminal line application



Assume the Hybrid Permissive Overreaching Transfer Trip (Hybrid POTT) scheme is applied using the architecture shown as follows. The scheme output operand **HYB POTT TX1** is used to key the permission.

Figure 5-177: Single-channel open-loop configuration



In this architecture, Devices 1 and 3 do not communicate directly. Therefore, Device 2 must act as a 'bridge'. The following settings are applied:

UR IEC 1:

- DIRECT OUT 2 OPERAND: "**HYB POTT TX1**"
- DIRECT INPUT 5 DEVICE ID: "2"
- DIRECT INPUT 5 BIT NUMBER: "2" (this is a message from IED 2)
- DIRECT INPUT 6 DEVICE ID: "2"
- DIRECT INPUT 6 BIT NUMBER: "4" (effectively, this is a message from IED 3)

UR IED 3:

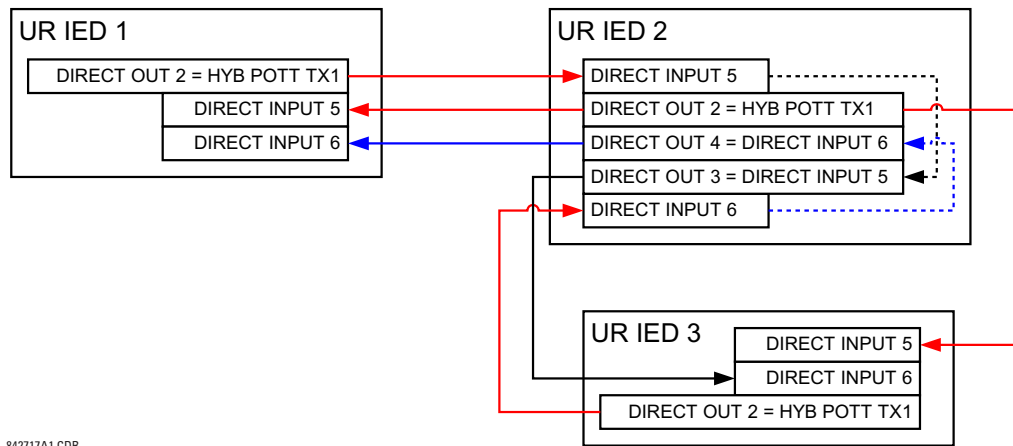
- DIRECT OUT 2 OPERAND: "**HYB POTT TX1**"
- DIRECT INPUT 5 DEVICE ID: "2"
- DIRECT INPUT 5 BIT NUMBER: "2" (this is a message from IED 2)
- DIRECT INPUT 6 DEVICE ID: "2"
- DIRECT INPUT 6 BIT NUMBER: "3" (effectively, this is a message from IED 1)

UR IED 2:

- DIRECT INPUT 5 DEVICE ID: "1"
- DIRECT INPUT 5 BIT NUMBER: "2"
- DIRECT INPUT 6 DEVICE ID: "3"
- DIRECT INPUT 6 BIT NUMBER: "2"
- DIRECT OUT 2 OPERAND: "**HYB POTT TX1**"
- DIRECT OUT 3 OPERAND: "**DIRECT INPUT 5**" (forward a message from 1 to 3)
- DIRECT OUT 4 OPERAND: "**DIRECT INPUT 6**" (forward a message from 3 to 1)

The figure shows the signal flow among the three IEDs.

Figure 5-178: Signal flow for direct input and output



842717A1.CDR

In three-terminal applications, both the remote terminals must grant permission to trip. Therefore, at each terminal, direct inputs 5 and 6 are ANDed in FlexLogic and the resulting operand configured as the permission to trip (**HYB POTT RX1** setting).

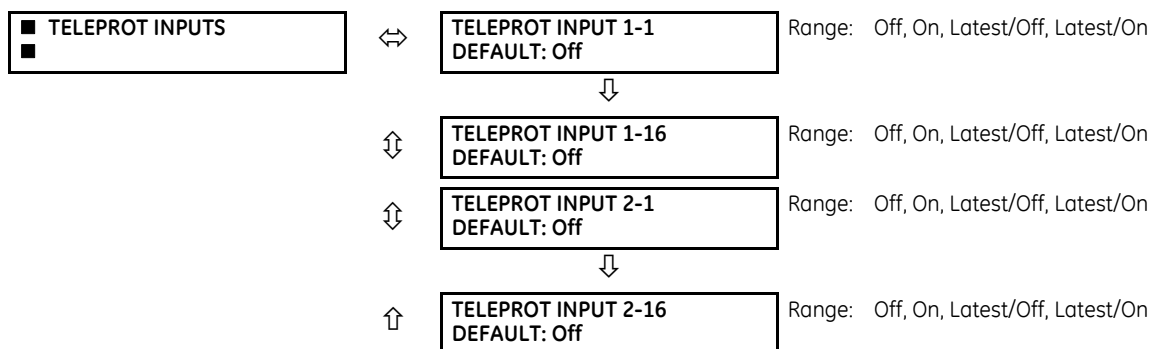
## 5.9.7 Teleprotection

### 5.9.7.1 Overview

The relay provides 16 teleprotection inputs on communications channel 1 (numbered 1-1 through 1-16) and 16 teleprotection inputs on communications channel 2 (on two-terminals two-channel and three-terminal systems only, numbered 2-1 through 2-16). The remote relay connected to channels 1 and 2 of the local relay is programmed by assigning FlexLogic operands to be sent via the selected communications channel. This allows the user to create distributed protection and control schemes via dedicated communications channels. Some examples are directional comparison pilot schemes and direct transfer tripping. Note that failures of communications channels affect teleprotection functionality. The teleprotection function must be enabled to utilize the inputs.

### 5.9.7.2 Teleprotection inputs

SETTINGS ⇨ INPUTS/OUTPUTS ⇨ TELEPROTECTION ⇨ TELEPROT INPUTS

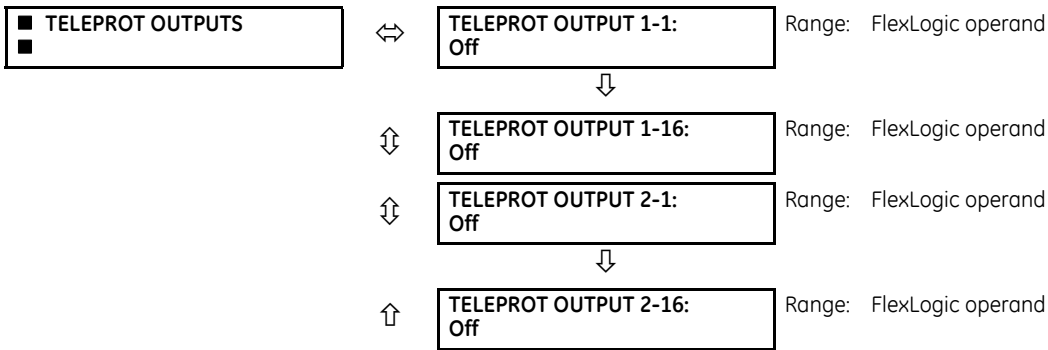


Setting the **TELEPROT INPUT ~- DEFAULT** setting to “On” defaults the input to logic 1 when the channel fails. A value of “Off” defaults the input to logic 0 when the channel fails.

The “Latest/On” and “Latest/Off” values freeze the input in case of lost communications. If the latest state is not known, such as after relay power-up but before the first communication exchange, then the input defaults to logic 1 for “Latest/On” and logic 0 for “Latest/Off.”

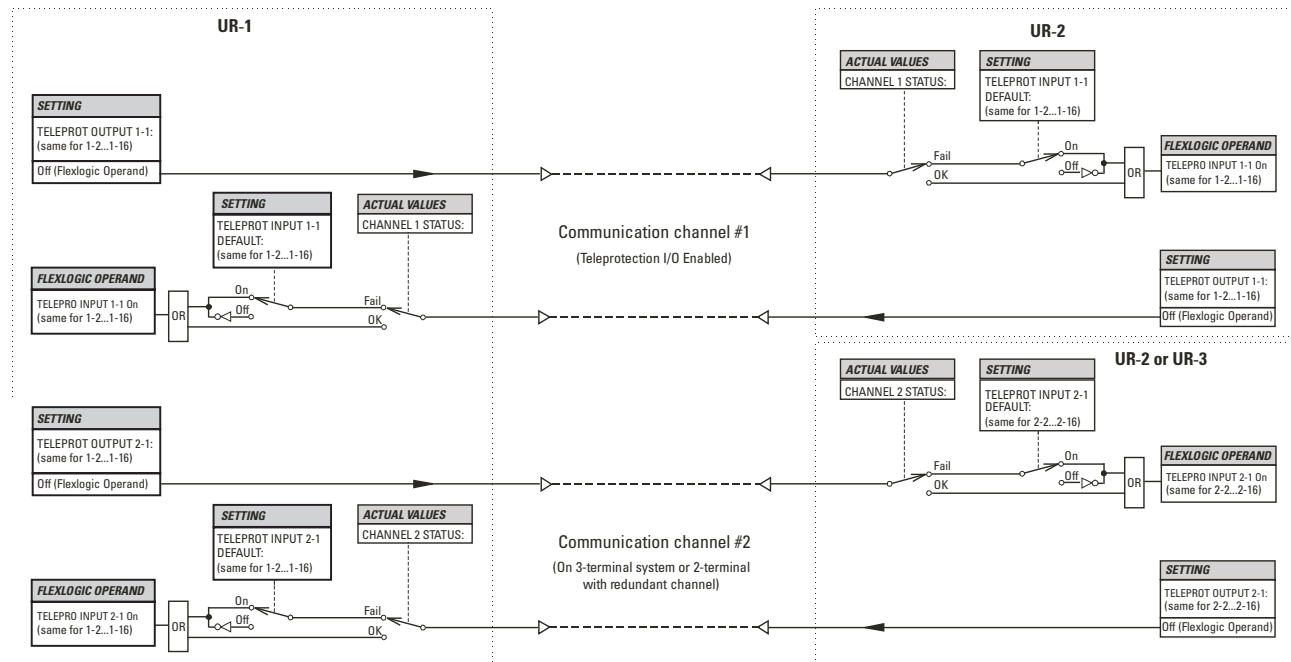
### 5.9.7.3 Teleprotection outputs

SETTINGS ⇄ INPUTS/OUTPUTS ⇄ TELEPROTECTION ⇄ TELEPROT OUTPUTS



As the following figure demonstrates, processing of the teleprotection inputs/outputs is dependent on the number of communication channels and terminals. On two-terminal two-channel systems, they are processed continuously on each channel and mapped separately per channel. Therefore, to achieve redundancy, the user must assign the same operand on both channels (teleprotection outputs at the sending end or corresponding teleprotection inputs at the receiving end). On three-terminal two-channel systems, redundancy is achieved by programming signal re-transmittal in the case of channel failure between any pair of relays.

Figure 5-179: Teleprotection input/output processing



842750A2.CDR

## 5.10 Transducer inputs/outputs

### 5.10.1 DCmA inputs

SETTINGS ⇒ ⇅ TRANSDUCER I/O ⇒ ⇅ DCMA INPUTS ⇒ DCMA INPUT F1(W8)

■ DCMA INPUT F1	⇅	DCMA INPUT F1 FUNCTION: Disabled	Range: Disabled, Enabled
	⇅	DCMA INPUT F1 ID: DCMA Ip 1	Range: up to 20 alphanumeric characters
	⇅	DCMA INPUT F1 UNITS: $\mu$ A	Range: six alphanumeric characters
	⇅	DCMA INPUT F1 RANGE: 0 to -1 mA	Range: 0 to -1 mA, 0 to +1 mA, -1 to +1 mA, 0 to 5 mA, 0 to 10mA, 0 to 20 mA, 4 to 20 m
	⇅	DCMA INPUT F1 MIN VALUE: 0.000	Range: -9999.999 to +9999.999 in steps of 0.001
	⇅	DCMA INPUT F1 MAX VALUE: 0.000	Range: -9999.999 to +9999.999 in steps of 0.001



The G30 is provided with optional DCmA capability. This feature is specified as an option at the time of ordering. See the Order Codes section in chapter 2 for details.

Hardware and software are provided to receive signals from external transducers and to convert these signals into a digital format for use as required. The relay accepts inputs in the range of -1 to +20 mA DC, suitable for use with most common transducer output ranges; all inputs are assumed to be linear over the complete range. Hardware details are contained in chapter 3.

Before the DCmA input signal can be used, the value of the signal measured by the relay must be converted to the range and quantity of the external transducer primary input parameter, such as DC voltage or temperature. The relay simplifies this process by internally scaling the output from the external transducer and displaying the actual primary parameter.

DCmA input channels are arranged in a manner similar to CT and VT channels. Configure the individual channels with the settings shown here.

The channels are arranged in sub-modules of two channels, numbered from 1 through 8 from top to bottom. On power-up, the relay automatically generates configuration settings for every channel, based on the order code, in the same general manner that is used for CTs and VTs. Each channel is assigned a slot letter followed by the row number, 1 through 8 inclusive, which is used as the channel number. The relay generates an actual value for each available input channel.

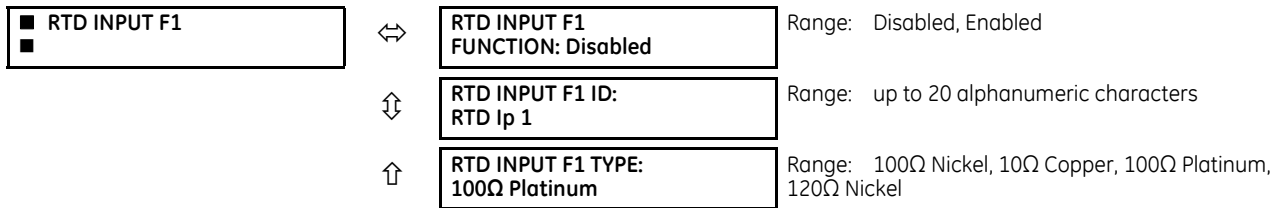
Settings are generated automatically for every channel available in the specific relay as shown above for the first channel of a type 5F transducer module installed in slot F.

The function of the channel can be “Enabled” or “Disabled.” If “Disabled,” no actual values are created for the channel. An alphanumeric “ID” is assigned to each channel; this ID is included in the channel actual value, along with the programmed units associated with the parameter measured by the transducer, such as volts, °C, megawatts, and so on. This ID is also used to reference the channel as the input parameter to features designed to measure this type of parameter. The **DCMA INPUT F1 RANGE** setting specifies the mA DC range of the transducer connected to the input channel.

The **DCMA INPUT F1 MIN VALUE** and **DCMA INPUT F1 MAX VALUE** settings are used to program the span of the transducer in primary units. For example, a temperature transducer might have a span from 0 to 250 °C; in this case the **DCMA INPUT F1 MIN VALUE** value is “0” and the **DCMA INPUT F1 MAX VALUE** value is “250.” Another example is a watts transducer with a span from -20 to +180 MW; in this case the **DCMA INPUT F1 MIN VALUE** value is “-20” and the **DCMA INPUT F1 MAX VALUE** value is “180.” Intermediate values between the minimum and maximum values are scaled linearly.

### 5.10.2 RTD inputs

SETTINGS ⇒ TRANSDUCER I/O ⇒ RTD INPUTS ⇒ RTD INPUT F1(W8)



Hardware and software is provided to receive signals from external resistance temperature detectors and convert these signals into a digital format for use as required. These channels are intended to be connected to any of the RTD types in common use. Specific hardware details are contained in chapter 3.

RTD input channels are arranged in a manner similar to CT and VT channels. The user configures individual channels with the settings shown here.

The channels are arranged in sub-modules of two channels, numbered from 1 through 8 from top to bottom. On power-up, the relay automatically generates configuration settings for every channel, based on the order code, in the same general manner that is used for CTs and VTs. Each channel is assigned a slot letter followed by the row number, 1 through 8 inclusive, which is used as the channel number. The relay generates an actual value for each available input channel.

Settings are automatically generated for every channel available in the specific relay as shown above for the first channel of a type 5C transducer module installed in the first available slot.

The function of the channel can be either “Enabled” or “Disabled.” If “Disabled,” there is not an actual value created for the channel. An alphanumeric ID is assigned to the channel; this ID is included in the channel actual values. It is also used to reference the channel as the input parameter to features designed to measure this type of parameter. Selecting the type of RTD connected to the channel configures the channel.

Actions based on RTD overtemperature, such as trips or alarms, are done in conjunction with the FlexElements feature. In FlexElements, the operate level is scaled to a base of 100°C. For example, a trip level of 150°C is achieved by setting the operate level at 1.5 pu. FlexElement operands are available to FlexLogic for further interlocking or to operate an output contact directly.

See the following table for reference temperature values for each RTD type.





Table 5-40: RTD temperature vs. resistance

Temperature		Resistance (in ohms)			
°C	°F	100 Ω Pt (DIN 43760)	120 Ω Ni	100 Ω Ni	10 Ω Cu
-50	-58	80.31	86.17	71.81	7.10
-40	-40	84.27	92.76	77.30	7.49
-30	-22	88.22	99.41	82.84	7.88
-20	-4	92.16	106.15	88.45	8.26
-10	14	96.09	113.00	94.17	8.65
0	32	100.00	120.00	100.00	9.04
10	50	103.90	127.17	105.97	9.42
20	68	107.79	134.52	112.10	9.81
30	86	111.67	142.06	118.38	10.19
40	104	115.54	149.79	124.82	10.58
50	122	119.39	157.74	131.45	10.97
60	140	123.24	165.90	138.25	11.35
70	158	127.07	174.25	145.20	11.74
80	176	130.89	182.84	152.37	12.12
90	194	134.70	191.64	159.70	12.51
100	212	138.50	200.64	167.20	12.90
110	230	142.29	209.85	174.87	13.28
120	248	146.06	219.29	182.75	13.67
130	266	149.82	228.96	190.80	14.06
140	284	153.58	238.85	199.04	14.44
150	302	157.32	248.95	207.45	14.83
160	320	161.04	259.30	216.08	15.22
170	338	164.76	269.91	224.92	15.61
180	356	168.47	280.77	233.97	16.00
190	374	172.46	291.96	243.30	16.39
200	392	175.84	303.46	252.88	16.78
210	410	179.51	315.31	262.76	17.17
220	428	183.17	327.54	272.94	17.56
230	446	186.82	340.14	283.45	17.95
240	464	190.45	353.14	294.28	18.34
250	482	194.08	366.53	305.44	18.73

### 5.10.3 DCmA outputs

SETTINGS ⇒ ⚙ TRANSDUCER I/O ⇒ ⚙ DCMA OUTPUTS ⇒ DCMA OUTPUT F1(W8)

■ DCMA OUTPUT F1	↔	DCMA OUTPUT F1 SOURCE: Off	Range: Off, any analog actual value parameter
	↕	DCMA OUTPUT F1 RANGE: -1 to 1 mA	Range: -1 to 1 mA, 0 to 1 mA, 4 to 20 mA
	↕	DCMA OUTPUT F1 MIN VAL: 0.000 pu	Range: -90.000 to 90.000 pu in steps of 0.001
	↑	DCMA OUTPUT F1 MAX VAL: 1.000 pu	Range: -90.000 to 90.000 pu in steps of 0.001

Hardware and software is provided to generate DCmA signals that allow interfacing with external equipment. Hardware details are contained in chapter 3. The DCmA output channels are arranged in a manner similar to transducer input or CT and VT channels. The user configures individual channels with the settings as follows.

The channels are arranged in sub-modules of two channels, numbered 1 through 8 from top to bottom. On power-up, the relay automatically generates configuration settings for every channel, based on the order code, in the same manner used for CTs and VTs. Each channel is assigned a slot letter followed by the row number, 1 through 8 inclusive, which is used as the channel number.

Both the output range and a signal driving a given output are user-programmable via the following settings menu (an example for channel M5 is shown).

The relay checks the driving signal ( $x$  in equations below) for the minimum and maximum limits, and subsequently re-scales so the limits defined as **MIN VAL** and **MAX VAL** match the output range of the hardware defined as **RANGE**. The following equation is applied:

$$I_{out} = \begin{cases} I_{min} & \text{if } x < \text{MIN VAL} \\ I_{max} & \text{if } x > \text{MAX VAL} \\ k(x - \text{MIN VAL}) + I_{min} & \text{otherwise} \end{cases} \quad \text{Eq. 5-66}$$

where

$x$  is a driving signal specified by the **SOURCE** setting

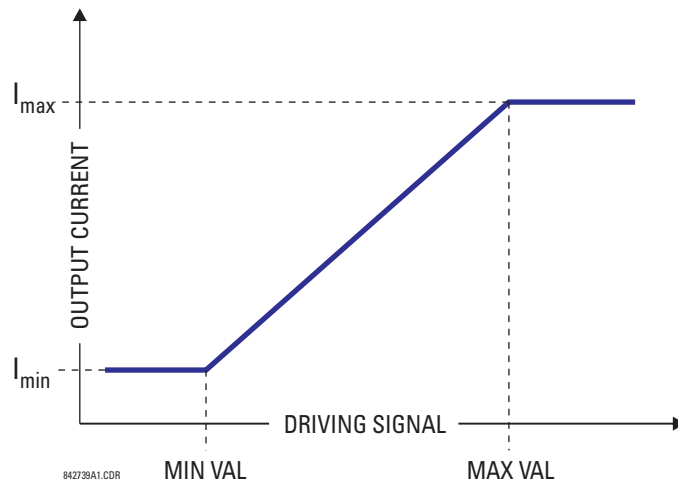
$I_{min}$  and  $I_{max}$  are defined by the **RANGE** setting

$k$  is a scaling constant calculated as:

$$k = \frac{I_{max} - I_{min}}{\text{MAX VAL} - \text{MIN VAL}} \quad \text{Eq. 5-67}$$

The feature is intentionally inhibited if the **MAX VAL** and **MIN VAL** settings are entered incorrectly, for example when **MAX VAL** - **MIN VAL** < 0.1 pu. The resulting characteristic is illustrated in the following figure.

Figure 5-180: DCmA output characteristic



### Settings

**DCMA OUTPUT F1 SOURCE** — This setting specifies an internal analog value to drive the analog output. Actual values (FlexAnalog parameters) such as power, current amplitude, voltage amplitude, power factor, etc. can be configured as sources driving DCmA outputs. See Appendix A for a list of FlexAnalog parameters.

**DCMA OUTPUT F1 RANGE** — This setting allows selection of the output range. Each DCmA channel can be set independently to work with different ranges. The three most commonly used output ranges are available.

**DCMA OUTPUT F1 MIN VAL** — This setting allows setting the minimum limit for the signal that drives the output. This setting is used to control the mapping between an internal analog value and the output current. The setting is entered in per-unit values. The base units are defined in the same manner as the FlexElement base units.

**DCMA OUTPUT F1 MAX VAL** — This setting allows setting the maximum limit for the signal that drives the output. This setting is used to control the mapping between an internal analog value and the output current. The setting is entered in per-unit values. The base units are defined in the same manner as the FlexElement base units.



The **DCMA OUTPUT F1 MIN VAL** and **DCMA OUTPUT F1 MAX VAL** settings are ignored for power factor base units (i.e. if the **DCMA OUTPUT F1 SOURCE** is set to FlexAnalog value based on power factor measurement).

Three application examples follow.

### Example: Power monitoring

A three phase active power on a 13.8 kV system measured via UR-series relay source 1 is to be monitored by the DCmA H1 output of the range of -1 to 1 mA. The following settings are applied on the relay: CT ratio = 1200:5, VT secondary 115, VT connection is delta, and VT ratio = 120. The nominal current is 800 A primary and the nominal power factor is 0.90. The power is to be monitored in both importing and exporting directions and allow for 20% overload compared to the nominal. The nominal three-phase power is:

$$P = \sqrt{3} \times 13.8 \text{ kV} \times 0.8 \text{ kA} \times 0.9 = 17.21 \text{ MW} \quad \text{Eq. 5-68}$$

The three-phase power with 20% overload margin is:

$$P_{\max} = 1.2 \times 17.21 \text{ MW} = 20.65 \text{ MW} \quad \text{Eq. 5-69}$$

The base unit for power (refer to the FlexElements section in this chapter for additional details) is:

$$P_{\text{BASE}} = 115 \text{ V} \times 120 \times 1.2 \text{ kA} = 16.56 \text{ MW} \quad \text{Eq. 5-70}$$

The minimum and maximum power values to be monitored (in pu) are:

$$\text{minimum power} = \frac{-20.65 \text{ MW}}{16.56 \text{ MW}} = -1.247 \text{ pu}, \quad \text{maximum power} = \frac{20.65 \text{ MW}}{16.56 \text{ MW}} = 1.247 \text{ pu} \quad \text{Eq. 5-71}$$

The following settings are entered:

- DCMA OUTPUT H1 SOURCE:** "SRC 1 P"
- DCMA OUTPUT H1 RANGE:** "-1 to 1 mA"
- DCMA OUTPUT H1 MIN VAL:** "-1.247 pu"
- DCMA OUTPUT H1 MAX VAL:** "1.247 pu"

With the above settings, the output will represent the power with the scale of 1 mA per 20.65 MW. The worst-case error for this application can be calculated by superimposing the following two sources of error:

- $\pm 0.5\%$  of the full scale for the analog output module, or  $\pm 0.005 \times (1 - (-1)) \times 20.65 \text{ MW} = \pm 0.207 \text{ MW}$
- $\pm 1\%$  of reading error for the active power at power factor of 0.9

For example at the reading of 20 MW, the worst-case error is  $0.01 \times 20 \text{ MW} + 0.207 \text{ MW} = 0.407 \text{ MW}$ .

### Example: Current monitoring

The phase A current (true RMS value) is to be monitored via the H2 current output working with the range from 4 to 20 mA. The CT ratio is 5000:5 and the maximum load current is 4200 A. The current is to be monitored from 0 A upwards, allowing for 50% overload.

The phase current with the 50% overload margin is:

$$I_{\max} = 1.5 \times 4.2 \text{ kA} = 6.3 \text{ kA} \quad \text{Eq. 5-72}$$

The base unit for current (see the FlexElements section in this chapter for additional details) is:

$$I_{BASE} = 5 \text{ kA} \tag{Eq. 5-73}$$

The minimum and maximum power values to be monitored (in pu) are:

$$\text{minimum current} = \frac{0 \text{ kA}}{5 \text{ kA}} = 0 \text{ pu}, \quad \text{maximum current} = \frac{6.3 \text{ kA}}{5 \text{ kA}} = 1.26 \text{ pu} \tag{Eq. 5-74}$$

The following settings are entered:

- DCMA OUTPUT H2 SOURCE:** "SRC 1 Ia RMS"
- DCMA OUTPUT H2 RANGE:** "4 to 20 mA"
- DCMA OUTPUT H2 MIN VAL:** "0.000 pu"
- DCMA OUTPUT H2 MAX VAL:** "1.260 pu"

The worst-case error for this application can be calculated by superimposing the following two sources of error:

- ±0.5% of the full scale for the analog output module, or ±0.005 × (20 - 4) × 6.3 kA = ±0.504 kA
- ±0.25% of reading or ±0.1% of rated (whichever is greater) for currents between 0.1 and 2.0 of nominal

For example, at the reading of 4.2 kA, the worst-case error is max(0.0025 × 4.2 kA, 0.001 × 5 kA) + 0.504 kA = 0.515 kA.

### Example: Voltage monitoring

A positive-sequence voltage on a 400 kV system measured via source 2 is to be monitored by the DCmA H3 output with a range of 0 to 1 mA. The VT secondary setting is 66.4 V, the VT ratio setting is 6024, and the VT connection setting is "Delta." The voltage is to be monitored in the range from 70% to 110% of nominal.

The minimum and maximum positive-sequence voltages to be monitored are:

$$V_{min} = 0.7 \times \frac{400 \text{ kV}}{\sqrt{3}} = 161.66 \text{ kV}, \quad V_{max} = 1.1 \times \frac{400 \text{ kV}}{\sqrt{3}} = 254.03 \text{ kV} \tag{Eq. 5-75}$$

The base unit for voltage (see the FlexElements section in this chapter for additional details) is:

$$V_{BASE} = 0.0664 \text{ kV} \times 6024 = 400 \text{ kV} \tag{Eq. 5-76}$$

The minimum and maximum voltage values to be monitored (in pu) are:

$$\text{minimum voltage} = \frac{161.66 \text{ kV}}{400 \text{ kV}} = 0.404 \text{ pu}, \quad \text{maximum voltage} = \frac{254.03 \text{ kV}}{400 \text{ kV}} = 0.635 \text{ pu} \tag{Eq. 5-77}$$

The following settings are entered:

- DCMA OUTPUT H3 SOURCE:** "SRC 2 V\_1 mag"
- DCMA OUTPUT H3 RANGE:** "0 to 1 mA"
- DCMA OUTPUT H3 MIN VAL:** "0.404 pu"
- DCMA OUTPUT H3 MAX VAL:** "0.635 pu"

The limit settings differ from the expected 0.7 pu and 1.1 pu because the relay calculates the positive-sequence quantities scaled to the phase-to-ground voltages, even if the VTs are connected in "Delta" (see the Metering Conventions section in chapter 6), while at the same time the VT nominal voltage is 1 pu for the settings. Consequently the settings required in this example differ from naturally expected by the factor of  $\sqrt{3}$ .

The worst-case error for this application could be calculated by superimposing the following two sources of error:

- ±0.5% of the full scale for the analog output module, or ± 0.005 × (1-0) × 254.03 kV = ±1.27 kV
- ±0.5% of reading

For example, under nominal conditions, the positive-sequence reads 230.94 kV and the worst-case error is 0.005 × 230.94 kV + 1.27 kV = 2.42 kV.

## 5.11 Testing

### 5.11.1 Test mode function

SETTINGS ⇄ TESTING ⇄ TEST MODE FUNCTION



The G30 provides a test facility to verify the functionality of contact inputs and outputs, some communication functions and the Phasor Measurement Unit (PMU, where applicable), using simulated conditions. It is accessible in the software and graphical front panel.

The **TEST MODE FUNCTION** can be in one of three states: Disabled, Isolated, or Forcible. In UR 7.7 and later, as outlined in the Simulation section that follows, the UR test mode and GOOSE simulation mode are Isolated, and they no longer depend on the UR **TEST MODE FUNCTION**.

The Disabled mode is intended for normal in service operation; the relay protection, control, and communication function is normal. Test features are disabled, except channel tests and Phasor Measurement Unit tests remain usable when provided.

The Isolated mode is intended to allow the relay to be quickly placed in a state where the relay cannot negatively impact the power system or other parts of the substation automation system. This is to allow changing settings, loading new firmware, changing hardware modules, and changing communication connections. As far as practical all relay output signals are blocked. Contact outputs are de-energized, latching outputs are frozen. Commands to HardFiber Bricks are blocked. GOOSE transmissions have their "simulation" flag (also known as "test" flag) set, which results in the messages not being accepted by compliant receiving devices that do not have a "Sim" data attribute set. The quality attribute of values that can be output via IEC 61850 MMS services are set to "invalid," which results in the values not being used for operational purposes by compliant receiving devices. Direct I/O channel tests and PMU tests are usable on applicable models.

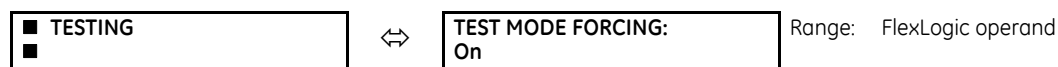
The Forcible mode is intended for testing involving forcing relay operation by test signal injection and verifying correct relay output. This mode is also for tests to verify the relay outputs (both contact and communications) have the intended impact on specific power system devices or on specific other substation automation devices. Contact outputs can be selectively enabled or forced as described in the following two sections. Shared outputs to Bricks have their test mode flag raised, which results in their value only being accepted by relays also in forcible mode. GOOSE transmissions have the "simulation" flag set, which results in these only being accepted by other devices that have their "Sim" data attribute set. The "Sim" data attribute in the relay is set, so that if GOOSE messages are received with the "simulation" flag set, these are used in place of the normal messages. The quality attribute of values that are output via IEC 61850 MMS services are set to "valid" + "test," which signals that the values are not to be used for operational purposes.

Otherwise, the UR remains fully operational while in the Forcible test mode, allowing for various testing procedures. In particular, the protection and control elements, and FlexLogic function normally. Other than the IEC 61850 protocol, communications based inputs and outputs remain fully operational. The test procedure must take this into account. Direct I/O channel tests and PMU tests are usable on applicable models.

The test mode can be selected through the front panel, EnerVista UR Setup software, or IEC 61850 control to LLN0.Mod. LLN0.Mod.ctlVal "on" selects Disabled, "test/blocked" selects Isolated, and "test" selects Forcible. The **TEST MODE FUNCTION** setting can only be changed by a direct user command. Following a restart, power up, settings upload, or firmware upgrade, the test mode remains at the last programmed value. This allows a UR that has been placed in isolated mode to remain isolated during testing and maintenance activities.

### 5.11.2 Test mode forcing

SETTINGS ⇄ TESTING ⇄ TEST MODE FORCING



When in Forcible mode, the operand selected by the **TEST MODE FORCING** setting dictates further response of the G30 to testing conditions, as described in the following two sections.

The test mode state is indicated on the relay front panel by a combination of the Test Mode LED indicator, the In-Service LED indicator, and by the critical fail relay, as shown in the following table.

**Table 5-41: Test mode operation**

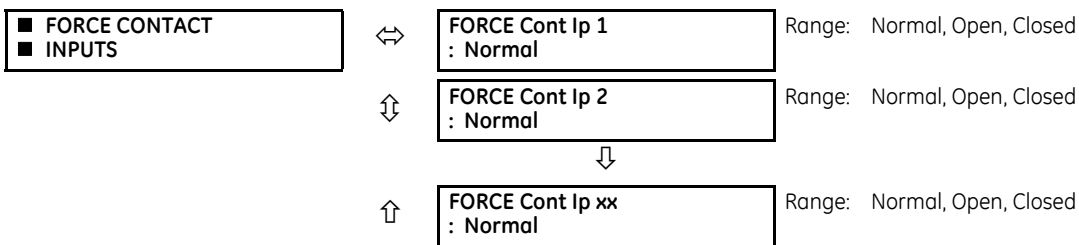
TEST MODE FUNCTION	In-service LED	Test mode LED	Critical fail relay	TEST MODE FORCING	Contact input and output behavior
Disabled	Unaffected	Off	Normal	No effect	Normal
Isolated	Off	On	De-energized	No effect	Contact outputs disabled
Forcible	Off	Flashing	De-energized	Off	Normal
				On	Controlled by forcing features



On restart, the **TEST MODE FORCING** setting and the force contact input and force contact output settings revert to their default states.

### 5.11.3 Force contact inputs

SETTINGS ⇨ TESTING ⇨ FORCE CONTACT INPUTS



The force contact inputs feature provides a method of performing checks on the function of all contact inputs.

While in Forcible test mode, the relay contact inputs can be pre-programmed to respond in the following ways:

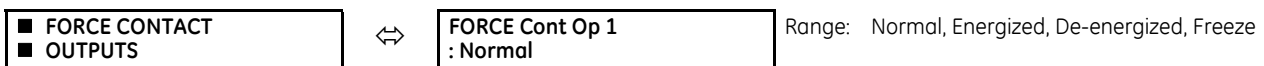
- If set to “Normal,” the input remains fully operational. It is controlled by the voltage across its input terminals and can be turned on and off by external circuitry. Select this value if a given input must be operational during the test. This includes, for example, an input initiating the test, or being a part of a user pre-programmed test sequence.
- If set to “Open,” the input is forced to report as opened (Logic 0) while the operand selected by **TEST MODE FORCING** setting is On, regardless of the voltage across the input terminals. While the selected operand is Off, the input behaves as it does when in service.
- If set to “Closed,” the input is forced to report as closed (Logic 1) while the operand selected by **TEST MODE FORCING** setting is On regardless of the voltage across the input terminals. While the selected operand is Off, the input behaves as it does when in service.

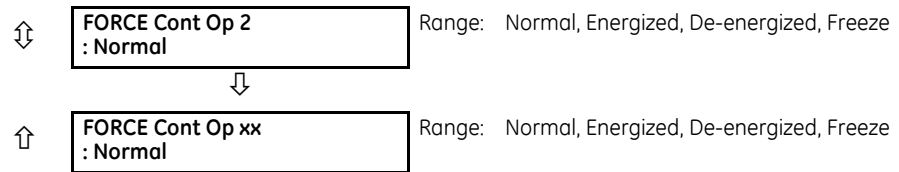


On restart, the **TEST MODE FORCING** setting and the force contact input and force contact output settings revert to their default states.

### 5.11.4 Force contact outputs

SETTINGS ⇨ TESTING ⇨ FORCE CONTACT OUTPUTS





The force contact outputs feature provides a method of performing checks on the function of all contact outputs.

While in Forcible test mode, the relay contact outputs can be pre-programmed to respond in the following ways:

- If set to "Normal," the contact output remains fully operational. It operates when its control operand is logic 1 and resets when its control operand is logic 0.
- If set to "Energized," the output closes and remains closed while the operand selected by the **TEST MODE FORCING** setting is On, regardless of the status of the operand configured to control the output contact. While the selected operand is Off, the output behaves as it does when in service.
- If set to "De-energized," the output opens and remains opened while the operand selected by the **TEST MODE FORCING** setting is On, regardless of the status of the operand configured to control the output contact. While the selected operand is Off, the output behaves as it does when in service.
- If set to "Freeze," the output retains its position at the instant before the **TEST MODE FUNCTION** was Forcible and the operand selected by the **TEST MODE FORCING** setting was On, regardless of later changes in the status of the operand configured to control the output contact. While the selected operand is Off, the output behaves as it does when in service.

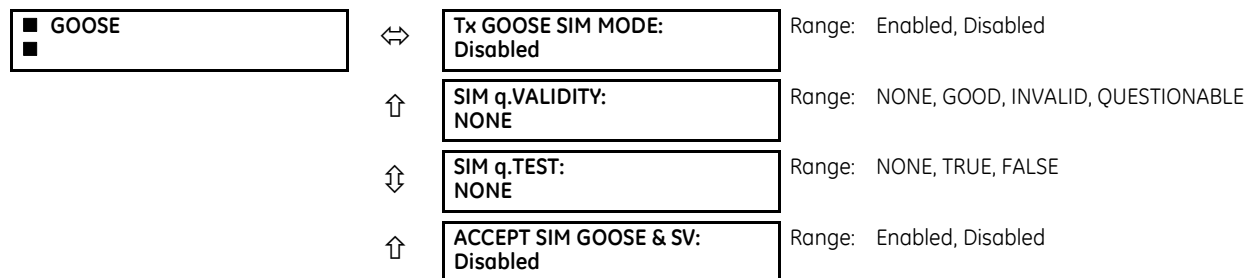


On restart, the **TEST MODE FORCING** setting and the force contact input and force contact output settings revert to their default states.

## 5.12 Simulation

### 5.12.1 GOOSE

SETTINGS ⇌ SIMULATION ⇌ GOOSE



Prior to UR 7.7, when the UR **TEST MODE FUNCTION** is set to "Isolated" or "Forcible," the sim bit in the header of all transmitted GOOSE messages is set to "TRUE," so that the UR plays the simulator role during the testing and commissioning phases. The "Sim" data attribute in the relay is set (<MasterLD>/LPHD1.Sim.stVal = TRUE), so that if GOOSE messages are received with the "simulation" flag set, these are used in place of the normal messages. The quality attribute values that are transmitted via GOOSE services are set to "valid" + "test."

In UR 7.7 and later, the UR test mode and GOOSE simulation mode are isolated. The sim bit in the transmitted GOOSE messages and the relay "Sim" attribute (<MasterLD>/LPHD1.Sim.stVal) are controlled via new Modbus settings and MMS control requests. They no longer depend on the UR **TEST MODE FUNCTION**.

When the G30 is set to IEC 61850 Edition 2, the settings display in the software and front panel. When using IEC 61850 Edition 1, the settings display in the software and are read-only.

**Tx GOOSE SIM MODE** — When set to Disabled, the sim bit in all transmitted GOOSE messages are set to FALSE. When set to Enabled, the sim bit in all transmitted GOOSE messages are set to TRUE. This setting also is accessible from IEC 61850 client control to <MasterLD>/LPHD1.TxGoSim.

**SIM q.VALIDITY** — This setting simulates the validity bits of the quality attribute values included in all transmitted GOOSE messages. This setting is used when **Tx GOOSE SIM MODE** is set to Enabled. When this setting is set to None, the q.Validity bits are set based on the logical node behavior value. When set to any other value, the q.Validity bits of quality attributes included in all transmitted GOOSE messages are set to the selected value.

**SIM q.TEST** — This setting simulates the Test bit of the quality attribute values included in all transmitted GOOSE messages. This setting is used when **Tx GOOSE SIM MODE** is set to Enabled. When this setting is set to None, the q.Test bit is set based on the relay **TEST MODE FUNCTION**. When set to any other value, the q.Test bit of quality attributes included in all transmitted GOOSE messages is set to the selected value.

**ACCEPT SIM GOOSE & SV** — When set to Disabled, the relay "Sim" attribute (<MasterLD>/LPHD1.Sim.stVal) is set to False and the GOOSE messages received with simulation flag set are ignored. When set to Enabled, the relay "Sim" attribute (<MasterLD>/LPHD1.Sim.stVal) is set to True, so that if GOOSE messages are received with the "simulation" flag set, these are used in place of the normal messages. This setting also is accessible from IEC 61850 client control to <MasterLD>/LPHD1.Sim.

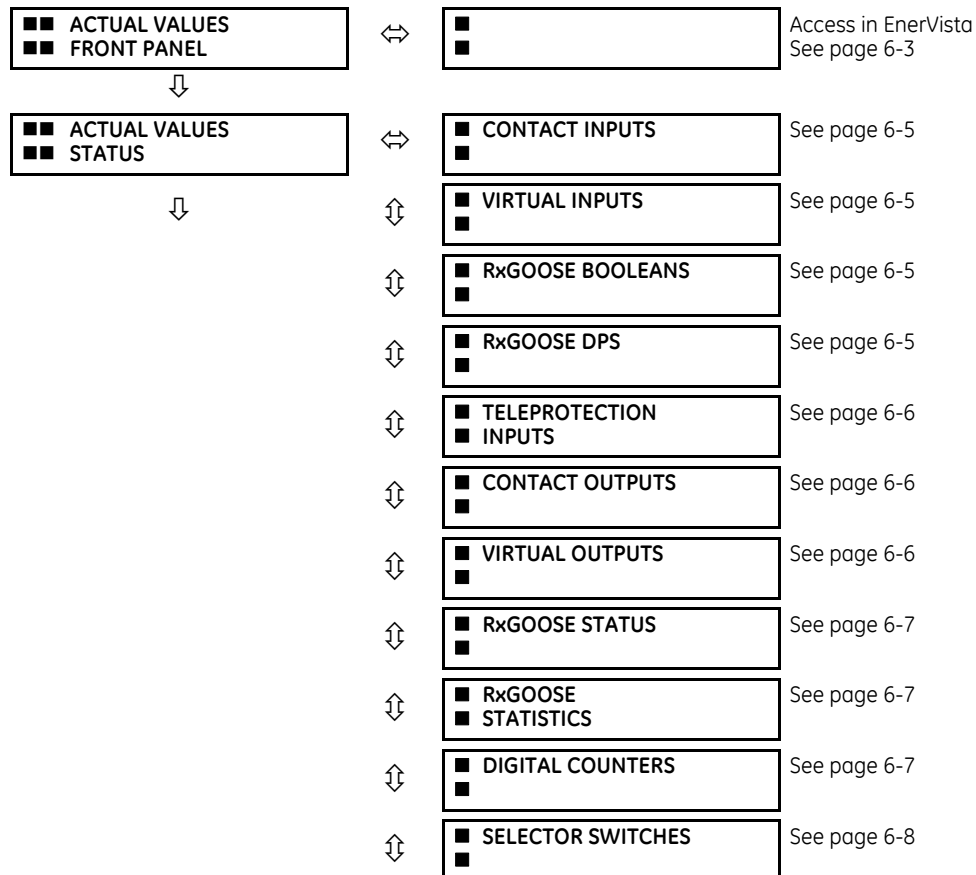


# G30 Generator Protection System

## Chapter 6: Actual values

This chapter outlines viewing of data on the front panel and in the software.

### 6.1 Actual Values menu

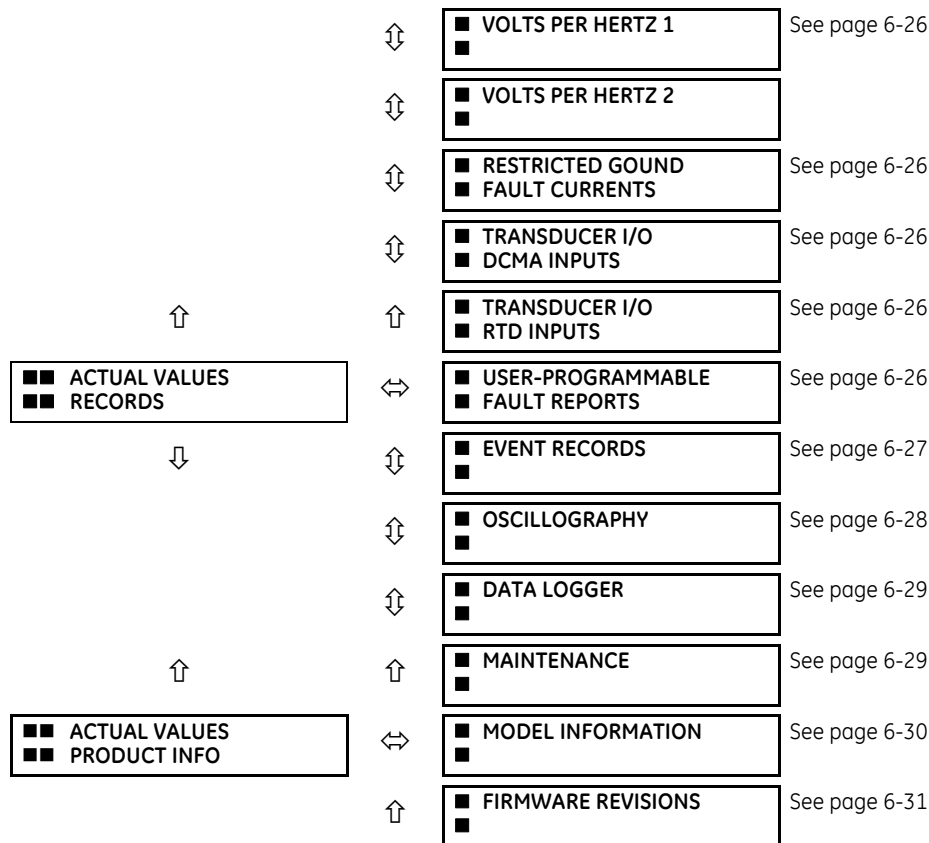


6

ACTUAL VALUES  
 METERING



⇅	<input type="checkbox"/> FLEX STATES <input type="checkbox"/>	See page 6-8
⇅	<input type="checkbox"/> ETHERNET <input type="checkbox"/>	See page 6-8
⇅	<input type="checkbox"/> REAL TIME CLOCK <input type="checkbox"/> SYNCHRONIZING	See page 6-8
⇅	<input type="checkbox"/> DIRECT INPUTS <input type="checkbox"/>	See page 6-9
⇅	<input type="checkbox"/> DIRECT DEVICES <input type="checkbox"/> STATUS	See page 6-10
⇅	<input type="checkbox"/> EGD PROTOCOL <input type="checkbox"/> STATUS	See page 6-10
⇅	<input type="checkbox"/> TELEPROT CH TESTS <input type="checkbox"/>	See page 6-11
⇅	<input type="checkbox"/> COMM STATUS <input type="checkbox"/> REMAINING CONNECT	See page 6-11
⇅	<input type="checkbox"/> PRP <input type="checkbox"/>	See page 6-12
⇅	<input type="checkbox"/> TxGOOSE STATUS <input type="checkbox"/>	See page 6-12
⇅	<input type="checkbox"/> PROTOCOL <input type="checkbox"/>	See page 6-13
↔	<input type="checkbox"/> TRANSFORMER <input type="checkbox"/>	See page 6-17
⇅	<input type="checkbox"/> SOURCE SRC 1 <input type="checkbox"/>	See page 6-18
⇅	<input type="checkbox"/> SOURCE SRC 2 <input type="checkbox"/>	
⇅	<input type="checkbox"/> SOURCE SRC 3 <input type="checkbox"/>	
⇅	<input type="checkbox"/> SOURCE SRC 4 <input type="checkbox"/>	
⇅	<input type="checkbox"/> SYNCHROCHECK <input type="checkbox"/>	See page 6-23
⇅	<input type="checkbox"/> TRACKING FREQUENCY <input type="checkbox"/>	See page 6-23
⇅	<input type="checkbox"/> FREQUENCY RATE <input type="checkbox"/> OF CHANGE	See page 6-24
⇅	<input type="checkbox"/> FREQUENCY OBB <input type="checkbox"/> ACCUMULATION	See page 6-24
⇅	<input type="checkbox"/> FLEXELEMENTS <input type="checkbox"/>	See page 6-24
⇅	<input type="checkbox"/> RxGOOSE Analogs <input type="checkbox"/>	See page 6-25
⇅	<input type="checkbox"/> SENSITIVE <input type="checkbox"/> DIRECTIONAL POWER	See page 6-25
⇅	<input type="checkbox"/> STATOR <input type="checkbox"/> GROUND	See page 6-25



For status reporting, 'On' represents Logic 1 and 'Off' represents Logic 0.

## 6.2 Front panel

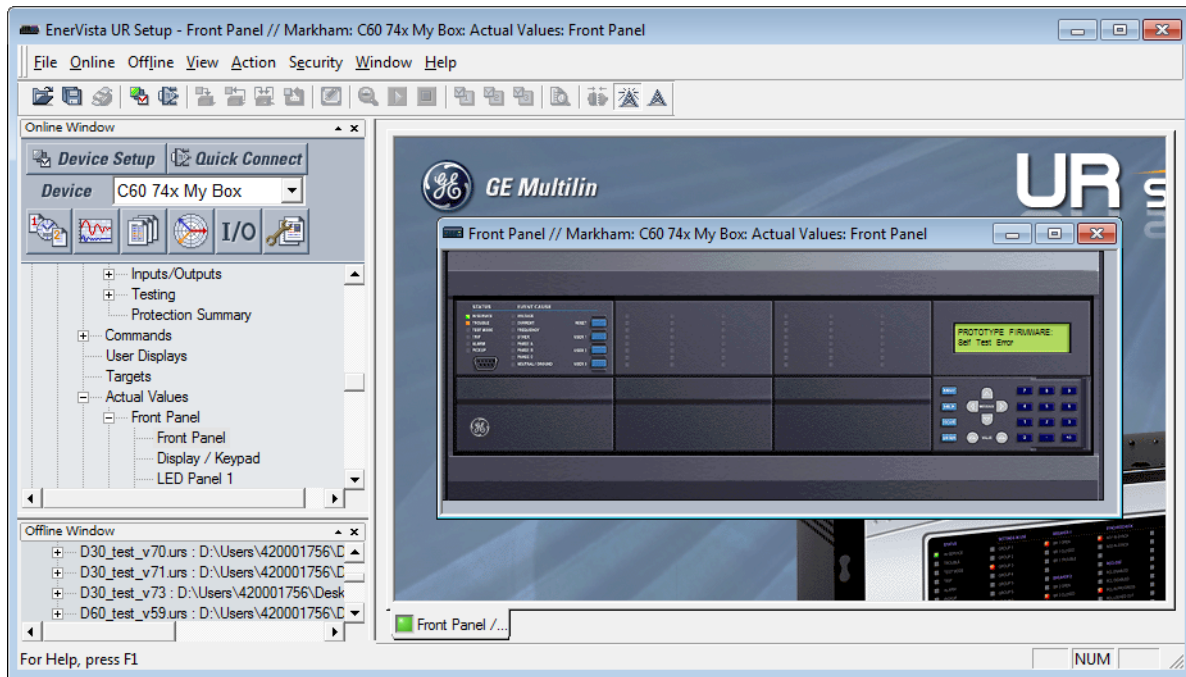
### 6.2.1 Enhanced and basic front panels

The front panel can be viewed and used in the EnerVista software, for example to view an error message displayed on the front panel.

To view the front panel in EnerVista software:

1. Click **Actual Values > Front Panel**.

Figure 6-1: Front panel use in the software (C60 shown)



## 6.2.2 Graphical front panel



The graphical front panel is a hardware option.

Annunciator alarms can be acknowledged and reset, and LEDs and pushbuttons can be viewed.

To view alarms for the graphical front panel in EnerVista:

1. Access **Actual Values > Graphical Panel > Annunciator Panel**. Alarms are listed, allowing remote acknowledgement/reset.
2. Click the **Acknowledge** or **Reset** button for an alarm.

Figure 6-2: Annunciator alarms displayed in the software)

PARAMETER	ALARM	ACTION
Indicator 1	NewTransientRecord	Acknowledge
Indicator 2	0.000	Acknowledge
Indicator 3	0.000	Acknowledge
Indicator 6	hiTest	Reset

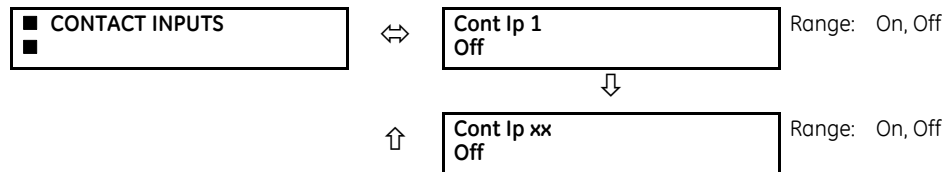
To view LEDs and pushbuttons on the graphical front panel in EnerVista:

1. Access **Actual Values > Graphical Panel > LEDs** or **Pushbuttons**. The window displays.

## 6.3 Status

### 6.3.1 Contact inputs

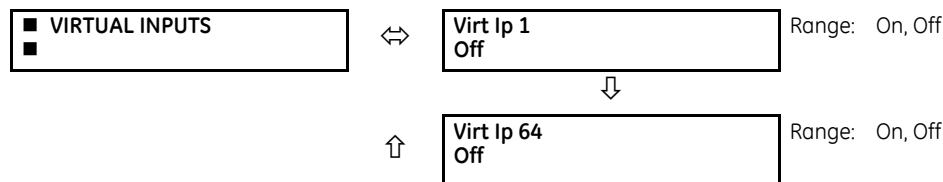
ACTUAL VALUES ⇒ STATUS ⇒ CONTACT INPUTS



The present status of the contact inputs is shown here. The first line of a message display indicates the ID of the contact input. For example, 'Cont Ip 1' refers to the contact input in terms of the default name-array index. The second line of the display indicates the logic state of the contact input.

### 6.3.2 Virtual inputs

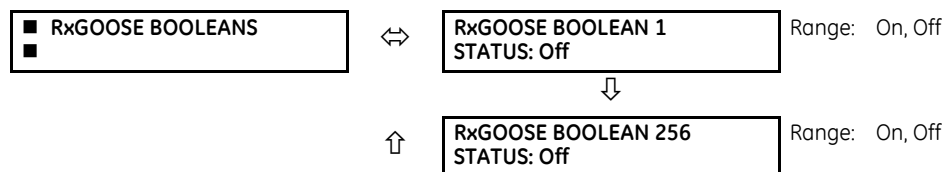
ACTUAL VALUES ⇒ STATUS ⇒↓ VIRTUAL INPUTS



The present status of the 64 virtual inputs is shown here. The first line of a message display indicates the ID of the virtual input. For example, 'Virt Ip 1' refers to the virtual input in terms of the default name. The second line of the display indicates the logic state of the virtual input.

### 6.3.3 RxGOOSE boolean inputs

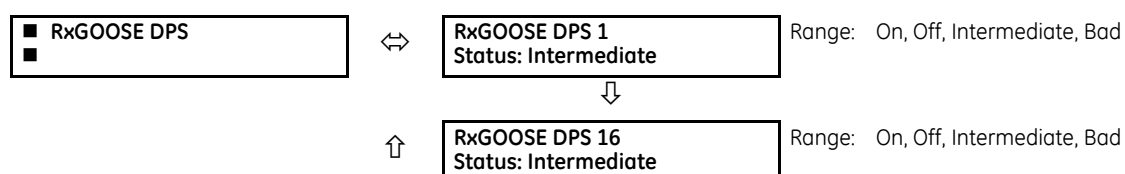
ACTUAL VALUES ⇒ STATUS ⇒↓ RxGOOSE BOOLEANS



The G30 is provided with optional IEC 61850 capability. This feature is specified as a software option at the time of ordering. See the Order Codes section of chapter 2 for details.

### 6.3.4 RxGOOSE DPS inputs

ACTUAL VALUES ⇒ STATUS ⇒↓ RxGOOSE DPS

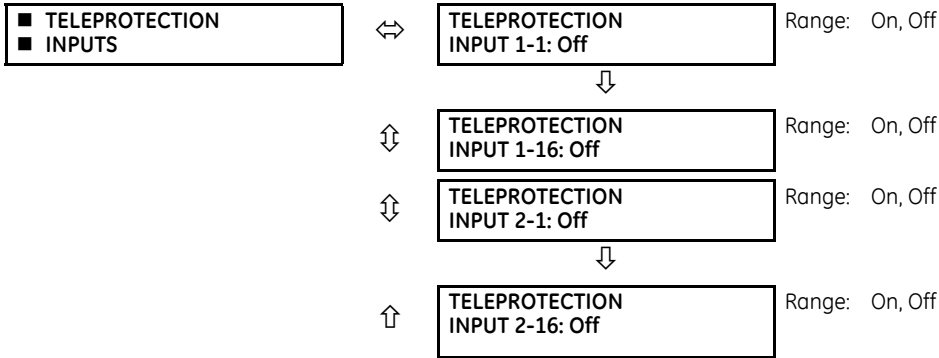




The G30 is provided with optional IEC 61850 capability. This feature is specified as a software option at the time of ordering. See the Order Codes section of chapter 2 for details.

### 6.3.5 Teleprotection inputs

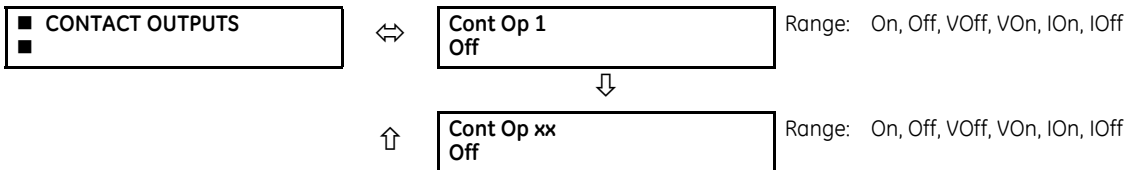
#### ACTUAL VALUES ⇒ STATUS ⇒ TELEPROTECTION INPUTS



The present state of teleprotection inputs from communication channels 1 and 2 are shown here. The state displayed is that of corresponding remote output unless the channel is declared failed.

### 6.3.6 Contact outputs

#### ACTUAL VALUES ⇒ STATUS ⇒ CONTACT OUTPUTS

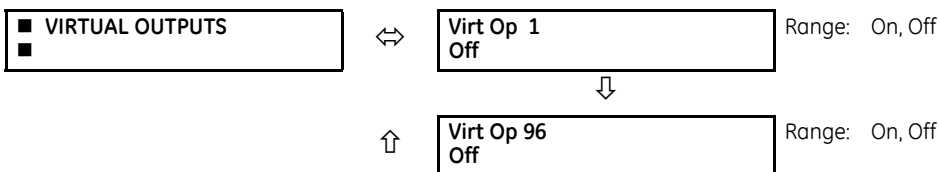


The present state of the contact outputs is shown here. The first line of a message display indicates the ID of the contact output. For example, 'Cont Op 1' refers to the contact output in terms of the default name-array index. The second line of the display indicates the logic state of the contact output.

For form-A contact outputs, the state of the voltage and current detectors is displayed as Off, VOff, IOff, On, IOOn, and VOn. For form-C contact outputs, the state is displayed as Off or On.

### 6.3.7 Virtual outputs

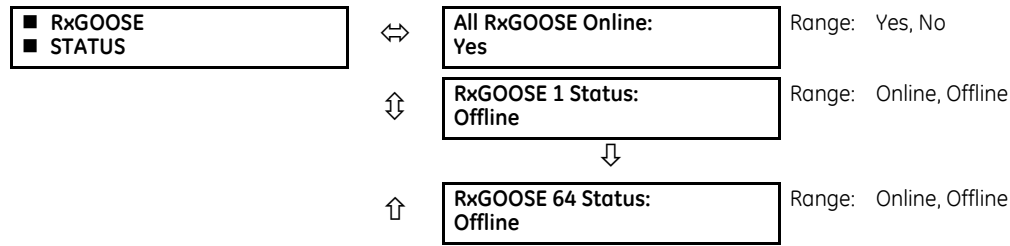
#### ACTUAL VALUES ⇒ STATUS ⇒ VIRTUAL OUTPUTS



The present state of up to 96 virtual outputs is shown here. The first line of a message display indicates the ID of the virtual output. For example, 'Virt Op 1' refers to the virtual output in terms of the default name-array index. The second line of the display indicates the logic state of the virtual output, as calculated by the FlexLogic equation for that output.

### 6.3.8 RxGOOSE status

ACTUAL VALUES ⇒ STATUS ⇒ ↓ RxGOOSE STATUS

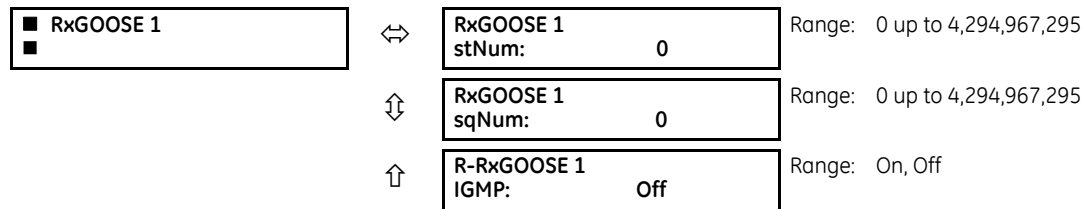


The G30 is provided with optional IEC 61850 capability. This feature is specified as a software option at the time of ordering. See the Order Codes section of chapter 2 for details.

The **All RxGOOSE Online** actual value does not consider RxGOOSE that are not configured or are not used by any RxGOOSE Input.

### 6.3.9 RxGOOSE statistics

ACTUAL VALUES ⇒ STATUS ⇒ ↓ RxGOOSE STATISTICS ⇒ ↓ RxGOOSE 1(64)



The G30 is provided with optional IEC 61850 capability. This feature is specified as a software option at the time of ordering. See the Order Codes section of chapter 2 for details.

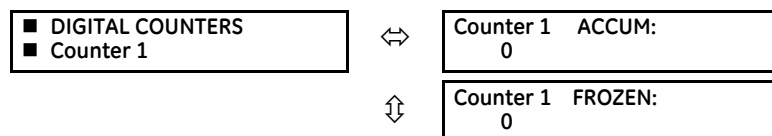
**stNum** — State number. The most recently received value in GOOSE message field stNum. The publisher increments stNum each time that the state of one or more of the GOOSE message members is sent with a revised value.

**sqNum** — Sequence number. The most recently received value in GOOSE message field sqNum. The publisher sets sqNum to zero each time the state of one or more of the GOOSE message members is sent with a new value, and it increments it whenever a GOOSE message is resent without any member value change.

**IGMP** — Multicast (SSM and ASM) modes of R-GOOSE reception require that the G30 device subscribe to a multicast group over the Internet Group Management Protocol (IGMP) enabled network. R-RxGOOSE## IGMP status On indicates that IGMP negotiation with a network device (for example a router) was successful. In the case where setting R-RxGOOSE1 DST IP is configured to a multicast address and this status indicates Off, R-GOOSE reception cannot be successful, and therefore communication network diagnosis needs to be carried out. This status is relevant to R-GOOSE reception when configured for SSM or ASM reception modes. It is not relevant for GOOSE or for R-GOOSE in unicast reception mode.

### 6.3.10 Digital counters

ACTUAL VALUES ⇒ STATUS ⇒ ↓ DIGITAL COUNTERS ⇒ DIGITAL COUNTERS Counter 1(8)



↕	Counter 1 FROZEN: 1970/01/01 00:00:00	Range: YYYY/MM/DD HH:MM:SS
↑	Counter 1 MICROS: 0	Range: 0 to 4294967295 in steps of 1

The present status of the eight digital counters displays here. The status of each counter, with the user-defined counter name, includes the accumulated and frozen counts (the count units label also appears). Also included, is the date and time stamp for the frozen count. The **COUNTER 1 MICROS** value refers to the microsecond portion of the time stamp.

### 6.3.11 Selector switches

ACTUAL VALUES ⇒ STATUS ⇒ ↕ SELECTOR SWITCHES

■ SELECTOR SWITCHES ■	↔	SELECTOR SWITCH 1 POSITION: 0/7	Range: Current Position / 7
	↑	SELECTOR SWITCH 2 POSITION: 0/7	Range: Current Position / 7

The display shows both the current position and the full range. The current position only (an integer from 0 through 7) is the actual value.

### 6.3.12 Flex States

ACTUAL VALUES ⇒ STATUS ⇒ ↕ FLEX STATES

■ FLEX STATES ■	↔	PARAM 1: Off Off	Range: On, Off
	↓	PARAM 256: Off Off	Range: On, Off

There are 256 FlexState™ bits available. The second line value indicates the state of the given FlexState bit.

### 6.3.13 Ethernet

ACTUAL VALUES ⇒ STATUS ⇒ ↕ ETHERNET

■ ETHERNET ■	↔	ETHERNET PRI LINK STATUS: Fail	Range: Fail, OK
	↕	ETHERNET SEC LINK STATUS: Fail	Range: Fail, OK
	↑	ETHERNET TER LINK STATUS: Fail	Range: Fail, OK

These values indicate the status of the first, second, and third Ethernet links.

### 6.3.14 Real time clock synchronizing

ACTUAL VALUES ⇒ STATUS ⇒ ↕ REAL TIME CLOCK SYNCHRONIZING

■ REAL TIME CLOCK ■ SYNCHRONIZING	↔	RTC SYNC SOURCE: None	Range: see below
	↕	GRANDMASTER ID: 0X0000000000000000	Range: any 8 octet value



⇅	<b>ACCURACY:</b> 999999999 ns	Range: 0 to 999,999,999 ns
⇅	<b>PORT 1 PTP STATE:</b> No Signal	Range: Disabled, No Signal, Calibrating, Synch'd (No Pdelay), Synchronized
⇅	<b>PORT 2 PTP STATE:</b> No Signal	Range: Disabled, No Signal, Calibrating, Synch'd (No Pdelay), Synchronized
⇅	<b>PORT 3 PTP STATE:</b> No Signal	Range: Disabled, No Signal, Calibrating, Synch'd (No Pdelay), Synchronized
↑	<b>PTP - IRIG-B DELTA:</b> 500000000 ns	Range: -500,000,000 to +500,000,000 ns



This item displays in the software when the product includes an IEEE 1588 software option.

**RTC SYNC SOURCE** actual value is the time synchronizing source the relay is using at present. Possible sources are: Port 1 PTP Clock, Port 2 PTP Clock, Port 3 PTP Clock, IRIG-B, SNTP1, SNTP2, and None. An actual value displays when the relay includes the IEEE 1588 software option.

The **GRANDMASTER ID** is the grandmasterIdentity code being received from the present PTP grandmaster, if any. When the relay is not using any PTP grandmaster, this actual value is zero. The grandmasterIdentity code is specified by PTP to be globally unique, so one can always know which clock is grandmaster in a system with multiple grandmaster-capable clocks.

**ACCURACY** is the estimated maximum time error at present in the RTC, considering the quality information imbedded in the received time signal. The value 999,999,999 indicates that the magnitude of the estimated error is one second or more, or that the error cannot be estimated.

**PORT 1...3 PTP STATE** is the present state of the port's PTP clock. The PTP clock state is:

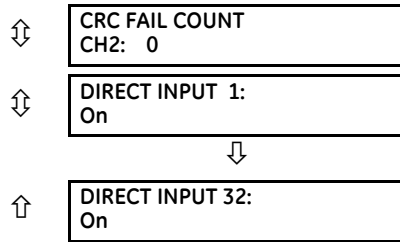
- **Disabled** is the port's function setting is Disabled
- **No Signal** if enabled but no signal from an active master has been found and selected
- **Calibrating** if an active master has been selected but lock is not at present established
- **Synch'd (No Pdelay)** if the port is synchronized, but the peer delay mechanism is non-operational
- **Synchronized** if synchronized

**PTP - IRIG-B DELTA** is the time difference, measured in nanoseconds, between the fractional seconds portion of the time being received via PTP and that being received via IRIG-B. A positive value indicates that PTP time is fast compared to IRIG-B time.

### 6.3.15 Direct inputs

ACTUAL VALUES ⇌ STATUS ⇌ DIRECT INPUTS

■ DIRECT INPUTS ■	↔	<b>AVERAGE MSG RETURN TIME CH1:</b> 0 ms
	⇅	<b>UNRETURNED MSG COUNT CH1:</b> 0
	⇅	<b>CRC FAIL COUNT CH1:</b> 0
	⇅	<b>AVERAGE MSG RETURN TIME CH2:</b> 0 ms
	⇅	<b>UNRETURNED MSG COUNT CH2:</b> 0



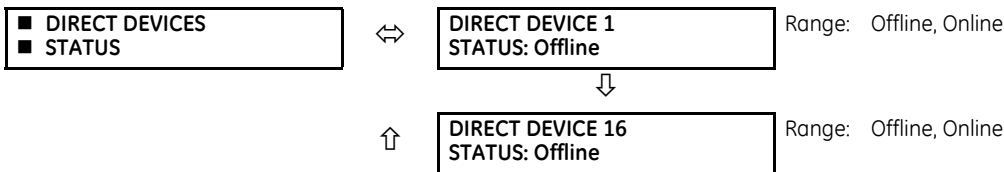
The **AVERAGE MSG RETURN TIME** is the time taken for direct output messages to return to the sender in a direct input/output ring configuration (this value is not applicable for non-ring configurations). This is a rolling average calculated for the last ten messages. There are two return times for dual-channel communications modules.

The **UNRETURNED MSG COUNT** values (one per communications channel) count the direct output messages that do not make the trip around the communications ring. The **CRC FAIL COUNT** values (one per communications channel) count the direct output messages that have been received but fail the CRC check. High values for either of these counts can indicate on a problem with wiring, the communication channel, or one or more relays. The **UNRETURNED MSG COUNT** and **CRC FAIL COUNT** values can be cleared using the **CLEAR DIRECT I/O COUNTERS** command.

The **DIRECT INPUT 1** to **DIRECT INPUT (32)** values represent the state of each direct input.

### 6.3.16 Direct devices status

ACTUAL VALUES ⇒ STATUS ⇒ DIRECT DEVICES STATUS



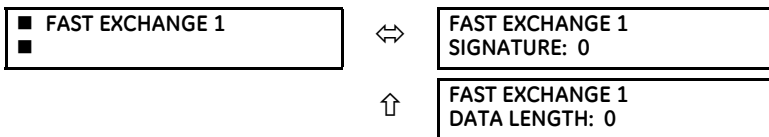
These actual values represent the state of direct devices 1 through 16.

## 6

### 6.3.17 EGD protocol status

#### 6.3.17.1 Fast exchange

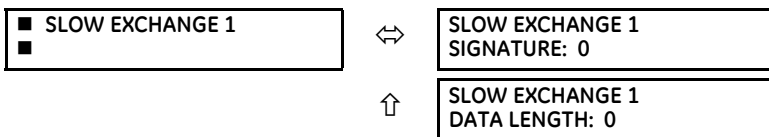
ACTUAL VALUES ⇒ STATUS ⇒ EGD PROTOCOL STATUS ⇒ PRODUCER STATUS ⇒ FAST EXCHANGE 1



These values provide information for debugging an Ethernet Global Data (EGD) network. The EGD signature and packet size for the fast EGD exchange display.

#### 6.3.17.2 Slow exchange

ACTUAL VALUES ⇒ STATUS ⇒ EGD PROTOCOL STATUS ⇒ PRODUCER STATUS ⇒ SLOW EXCHANGE 1(2)



These values provide information for debugging an EGD network. The EGD signature and packet size for the slow EGD exchanges display.

### 6.3.18 Teleprotection channel tests

#### ACTUAL VALUES ⇒ STATUS ⇒ TELEPROT CH TESTS

■ TELEPROT CH TESTS ■	↔	CHANNEL 1 STATUS: n/a	Range: n/a, FAIL, OK
	⇅	CHANNEL 1 LOST PACKETS: 1	Range: 1 to 65535 in steps of 1
	⇅	CHANNEL 2 STATUS: n/a	Range: n/a, FAIL, OK
	⇅	CHANNEL 2 LOST PACKETS: 1	Range: 1 to 65535 in steps of 1
	↑	VALIDITY OF CHANNEL CONFIGURATION: FAIL	Range: n/a, FAIL, OK

The status information for two channels is shown here.

**CHANNEL 1 STATUS** — This represents the receiver status of each channel. If the value is “OK,” teleprotection is enabled and data is being received from the remote terminal; If the value is “FAIL,” teleprotection enabled and data is not being received from the remote terminal. If “n/a,” teleprotection is disabled.

**CHANNEL 1 LOST PACKETS** — Data is transmitted to the remote terminals in data packets at a rate of two packets per cycle. The number of lost packets represents data packets lost in transmission; this count can be reset to 0 through the **COMMANDS ⇒ CLEAR RECORDS** menu.

**VALIDITY OF CHANNEL CONFIGURATION** — This value displays the current state of the communications channel identification check, and hence validity. If a remote relay ID does not match the programmed ID at the local relay, the “FAIL” message displays. The “N/A” value appears if the local relay ID is set to a default value of “0,” the channel is failed, or if the teleprotection inputs/outputs are not enabled.

### 6.3.19 Remaining connection status

#### ACTUAL VALUES ⇒ STATUS ⇒ COMM STATUS REMAINING CONNECT

■ COMM STATUS ■ REMAINING CONNECT	↔	MMS TCP(max 5) 5	Range: 0 to 5
	⇅	MODBUS TCP (max 4) 4	Range: 0 to 4
	⇅	DNP TCP(max 2) 2	Range: 0 to 2
	⇅	IEC-104 TCP(max 2) 2	Range: 0 to 2
	↑	SFTP (max 4) 4	Range: 0 to 4

These values specify the remaining number of TCP connections still available for each protocol. The display depends on the options applicable to your device. Each time a connection is used, the remaining number of connections decrements. When released, the remaining number of connections increments. If no connection is made over the specific protocol, the number equals the maximum number available for the specific protocol.

For example, the maximum number of Modbus TCP connections is 4. Once an EnerVista session is opened on a computer connected to the UR over Ethernet, the Modbus TCP status shows 3. If the EnerVista application is closed, the Modbus TCP status shows 4.

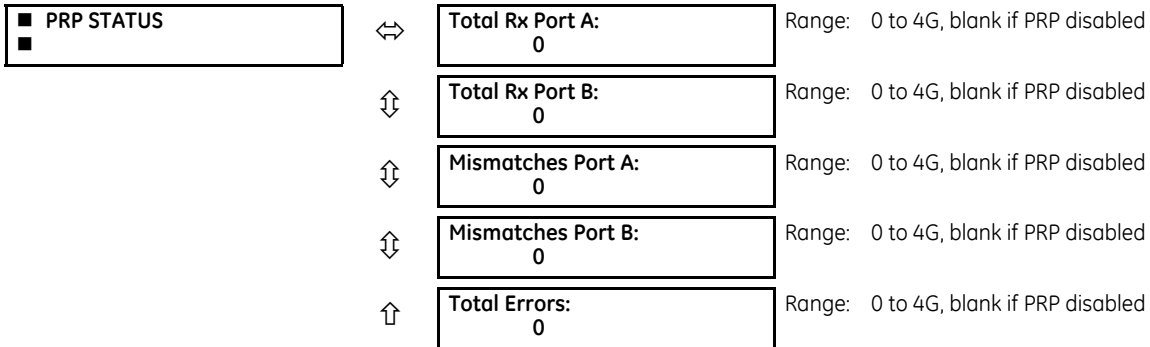
For the graphical front panel, the remaining connections refer to TCP connections only.

**MMS TCP** — The number of IEC 61850 connections remaining.

### 6.3.20 Parallel Redundancy Protocol (PRP)

The Parallel Redundancy Protocol (PRP) defines a redundancy protocol for high availability in substation automation networks.

#### ACTUAL VALUES ⇒ STATUS ⇒⇅ PRP STATUS



The G30 is provided with optional PRP capability. This feature is specified as a software option at the time of ordering. See the Order Codes section in chapter 2 for details.

**Total Received Port A** is a counter for total messages received (either from DANPs or from SANs) on Port A.

**Total Received Port B** is a counter for total messages received (either from DANPs or from SANs) on Port B.

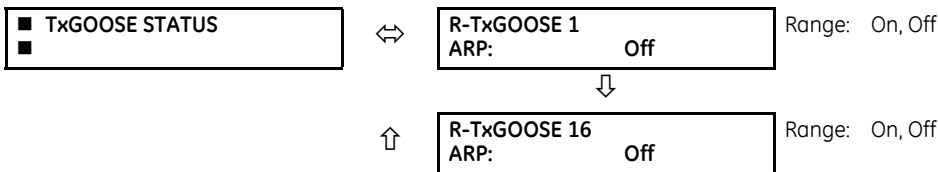
**Total Errors** is a counter for total messages received with an error (bad port code, frame length too short).

**Mismatches Port A** is a counter for total messages received with an error on Port A (PRP frame, but port received through and LAN ID in the frame do not match).

**Mismatches Port B** is a counter for total messages received with an error on Port B (PRP frame, but port received through and LAN ID in the frame do not match).

### 6.3.21 TxGOOSE status

#### ACTUAL VALUES ⇒ STATUS ⇒⇅ TxGOOSE STATUS



The G30 is provided with optional IEC 61850 capability. This feature is specified as a software option at the time of ordering. See the Order Codes section of chapter 2 for details.

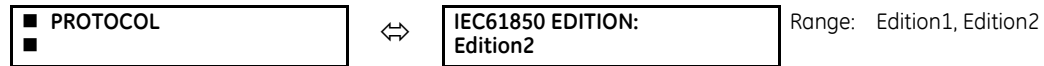
This status is relevant to R-GOOSE reception when configured for SSM or ASM reception modes. It is not relevant for GOOSE or for R-GOOSE in unicast reception mode.

**ARP** — The unicast mode of R-GOOSE transmission requires Address Resolution Protocol (ARP) for the resolution of the network layer address into the MAC layer address. R-TxGOOSE## ARP status On indicates that ARP responses are being received and the destination MAC address for R-GOOSE transmissions has been obtained. This status remains Off if TxGOOSE## is not configured for R-GOOSE. It also remains Off if setting R-TxGOOSE1 DST IP is set to a multicast address. In the case where setting R-TxGOOSE1 DST IP is configured with a unicast address and this status indicates Off, TxGOOSE## transmission will be off, and therefore communication network diagnosis needs to be carried out.

This status is only applicable for R-GOOSE transmission with setting R-TxGOOSE1 DST IP set to a unicast IP address. It is not applicable for GOOSE or for R-GOOSE when setting R-TxGOOSE1 DST IP is multicast.

## 6.3.22 Protocol

ACTUAL VALUES ⇌ STATUS ⇌ PROTOCOL



The G30 is provided with optional IEC 61850 capability. This feature is specified as a software option at the time of ordering. See the Order Codes section of chapter 2 for details.

Displays the IEC 61850 edition currently being used, as set under **Settings > Product Setup > Communications > Protocol > IEC61850 SCL Edition**. This value displays only on the front panel.

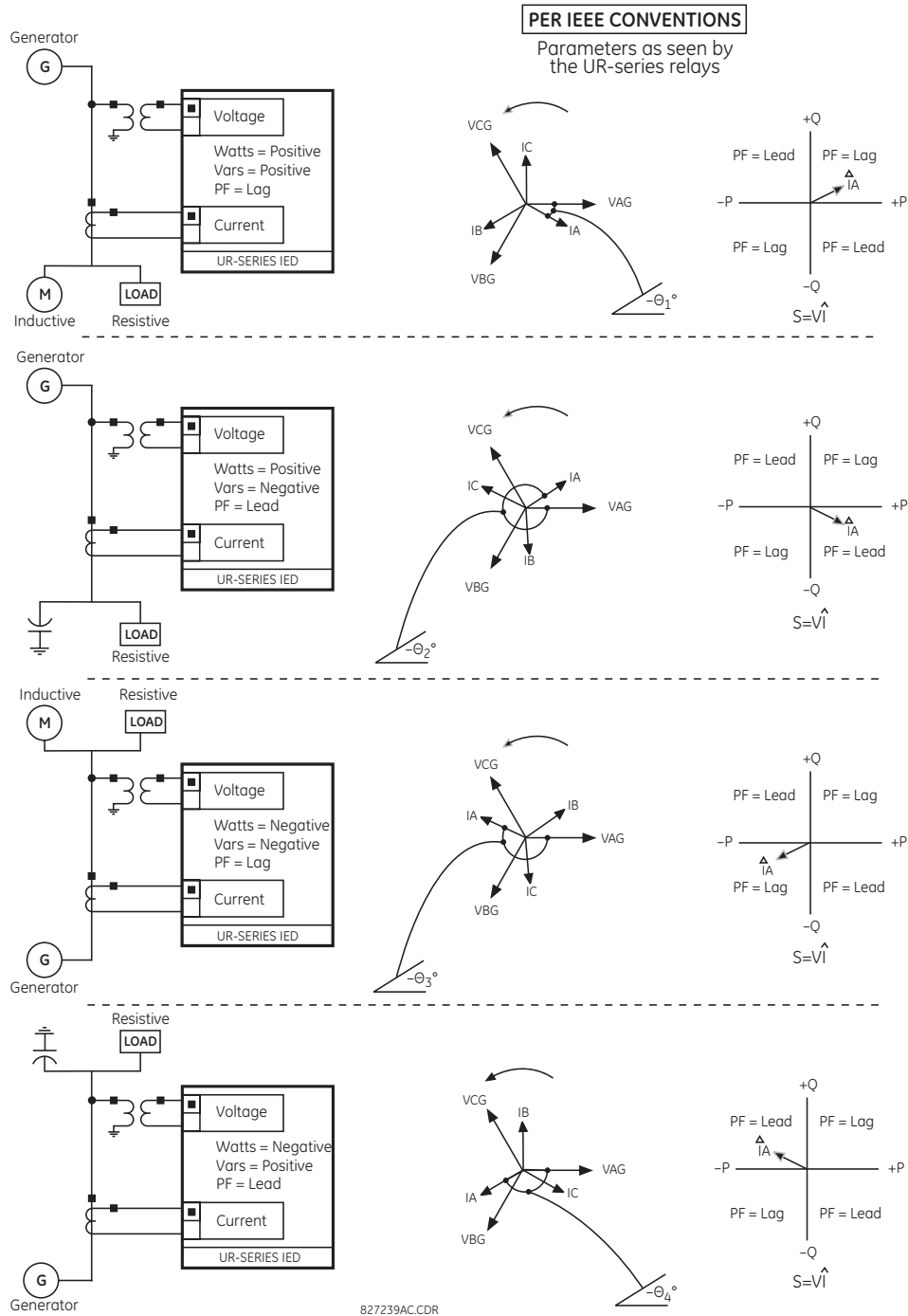
## 6.4 Metering

### 6.4.1 Metering conventions

#### 6.4.1.1 UR convention for measuring power and energy

The figure illustrates the conventions established for use in UR devices.

Figure 6-3: Flow direction of signed values for watts and VARs



6

6.4.1.2 UR convention for measuring phase angles

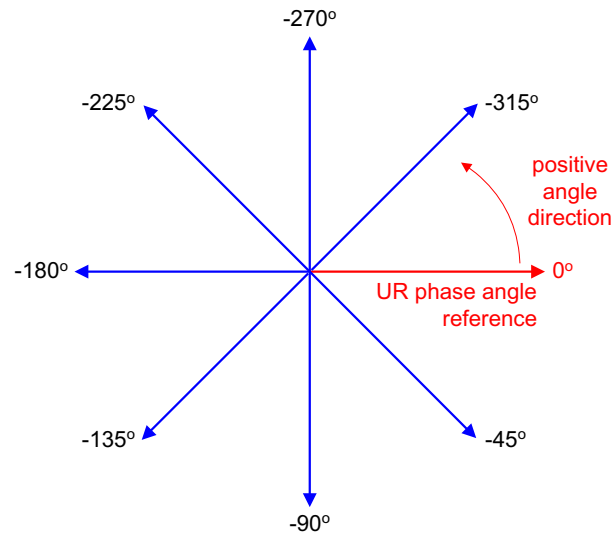
All phasors calculated by URs and used for protection, control and metering functions are rotating phasors that maintain the correct phase angle relationships with each other at all times.

For display and oscillography purposes, all phasor angles in a given relay are referred to an AC input channel pre-selected by the **SETTINGS** ⇒ **SYSTEM SETUP** ⇒ **POWER SYSTEM** ⇒ **FREQUENCY AND PHASE REFERENCE** setting. This setting defines a particular AC signal source to be used as the reference.

The relay first determines if any “Phase VT” bank is indicated in the source. If it is, voltage channel VA of that bank is used as the angle reference. Otherwise, the relay determines if any “Aux VT” bank is indicated; if it is, the auxiliary voltage channel of that bank is used as the angle reference. If neither of the two conditions is satisfied, then two more steps of this hierarchical procedure to determine the reference signal include “Phase CT” bank and “Ground CT” bank.

If the AC signal pre-selected by the relay upon configuration is not measurable, the phase angles are not referenced. The phase angles are assigned as positive in the leading direction, and are presented as negative in the lagging direction, to more closely align with power system metering conventions. The figure illustrates this.

Figure 6-4: UR phase angle measurement convention



827845A1.CDR

### 6.4.1.3 UR convention for measuring symmetrical components

The URs calculate voltage symmetrical components for the power system phase A line-to-neutral voltage, and symmetrical components of the currents for the power system phase A current. Owing to the above definition, phase angle relations between the symmetrical currents and voltages stay the same irrespective of the connection of instrument transformers. This is important for setting directional protection elements that use symmetrical voltages.

For display and oscillography purposes the phase angles of symmetrical components are referenced to a common reference as described in the previous sub-section.

#### WYE-connected instrument transformers

- ABC phase rotation:

$$V_0 = \frac{1}{3}(V_{AG} + V_{BG} + V_{CG})$$

$$V_1 = \frac{1}{3}(V_{AG} + aV_{BG} + a^2V_{CG})$$

$$V_2 = \frac{1}{3}(V_{AG} + a^2V_{BG} + aV_{CG})$$

- ACB phase rotation:

$$V_0 = \frac{1}{3}(V_{AG} + V_{BG} + V_{CG})$$

$$V_1 = \frac{1}{3}(V_{AG} + a^2V_{BG} + aV_{CG})$$

$$V_2 = \frac{1}{3}(V_{AG} + aV_{BG} + a^2V_{CG})$$

The above equations apply to currents as well.

**DELTA-connected instrument transformers**

- ABC phase rotation:

$$V_0 = N/A$$

$$V_1 = \frac{1\angle-30^\circ}{3\sqrt{3}}(V_{AB} + \alpha V_{BC} + \alpha^2 V_{CA})$$

$$V_2 = \frac{1\angle30^\circ}{3\sqrt{3}}(V_{AB} + \alpha^2 V_{BC} + \alpha V_{CA})$$

- ACB phase rotation:

$$V_0 = N/A$$

$$V_1 = \frac{1\angle30^\circ}{3\sqrt{3}}(V_{AB} + \alpha^2 V_{BC} + \alpha V_{CA})$$

$$V_2 = \frac{1\angle-30^\circ}{3\sqrt{3}}(V_{AB} + \alpha V_{BC} + \alpha^2 V_{CA})$$

The zero-sequence voltage is not measurable under the Delta connection of instrument transformers and is defaulted to zero. The table below shows an example of symmetrical components calculations for the ABC phase rotation.

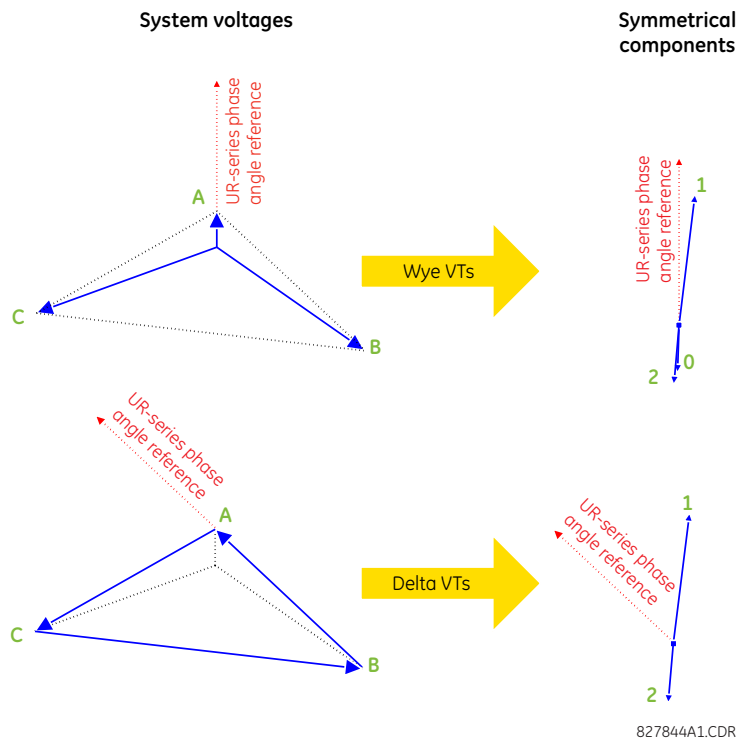
**Table 6-1: Symmetrical components calculation example**

SYSTEM VOLTAGES, sec. V *						VT conn.	relay INPUTS, sec. V			SYMM. COMP, sec. V		
V <sub>AG</sub>	V <sub>BG</sub>	V <sub>CG</sub>	V <sub>AB</sub>	V <sub>BC</sub>	V <sub>CA</sub>		F5ac	F6ac	F7ac	V <sub>0</sub>	V <sub>1</sub>	V <sub>2</sub>
13.9 ∠0°	76.2 ∠-125°	79.7 ∠-250°	84.9 ∠-313°	138.3 ∠-97°	85.4 ∠-241°	WYE	13.9 ∠0°	76.2 ∠-125°	79.7 ∠-250°	19.5 ∠-192°	56.5 ∠-7°	23.3 ∠-187°
UNKNOWN (only V <sub>1</sub> and V <sub>2</sub> can be determined)			84.9 ∠0°	138.3 ∠-144°	85.4 ∠-288°	DELTA	84.9 ∠0°	138.3 ∠-144°	85.4 ∠-288°	N/A	56.5 ∠-54°	23.3 ∠-234°

\* The power system voltages are phase-referenced – for simplicity – to V<sub>AG</sub> and V<sub>AB</sub>, respectively. This, however, is a relative matter. It is important to remember that the G30 displays are always referenced as specified under **SETTINGS** ⇒ **SYSTEM SETUP** ⇒ **POWER SYSTEM** ⇒ **FREQUENCY AND PHASE REFERENCE**.

The example above is illustrated in the following figure.

**Figure 6-5: Measurement convention for symmetrical components**





## 6.4.2 Transformer

### 6.4.2.1 Differential and restraint currents

ACTUAL VALUES ⇌ METERING ⇌ TRANSFORMER ⇌ DIFFERENTIAL AND RESTRAINT

<ul style="list-style-type: none"> <li>■ DIFFERENTIAL AND</li> <li>■ RESTRAINT</li> </ul>	↔	REFERENCE WINDING: Winding 1
	↕	DIFF PHASOR Iad: 0.000 pu 0.0°
	↕	REST PHASOR Iar: 0.000 pu 0.0°
	↕	DIFF 2ND HARM Iad: 0.0% fo 0.0°
	↕	DIFF 5TH HARM Iad: 0.0% fo 0.0°
	↕	DIFF PHASOR Ibd: 0.000 pu 0.0°
	↕	REST PHASOR Ibr: 0.000 pu 0.0°
	↕	DIFF 2ND HARM Ibd: 0.0% fo 0.0°
	↕	DIFF 5TH HARM Ibd: 0.0% fo 0.0°
	↕	DIFF PHASOR Icd: 0.000 pu 0.0°
	↕	REST PHASOR Icr: 0.000 pu 0.0°
	↕	DIFF 2ND HARM Icd: 0.0% fo 0.0°
	↕	DIFF 5TH HARM Icd: 0.0% fo 0.0°

The metered differential current, restraint current, second harmonic current, and fifth harmonic current are displayed for each phase. See the Percent Differential section in chapter 5 for details on how these values are calculated.

If differential current in any phase is below the hard-coded cutoff of 0.04 pu, then the differential, 2nd harmonic, and 5th harmonic currents are forced to zero.

### 6.4.2.2 Thermal elements

ACTUAL VALUES ⇌ METERING ⇌ TRANSFORMER ⇌ THERMAL ELEMENTS

<ul style="list-style-type: none"> <li>■ THERMAL</li> <li>■ ELEMENTS</li> </ul>	↔	TOP OIL °C: 70°C
	↕	HOTTEST-SPOT °C: 130°
	↕	AGING FACTOR: 1.2
	↕	DAILY RATE LOL: 15 hrs
	↕	XFMR LIFE LOST: 100000 hrs

The daily rate loss of life is summarized at 00:00 h, and displayed for the next 24 hour period. The transformer accumulated loss of life in hours is also available. It can be reset by either changing the **XFMR INITIAL LOSS OF LIFE** setting or through the **COMMANDS** ⇒ **↓ CLEAR RECORDS** ⇒ **↓ CLEAR LOSS OF LIFE RECORDS** command.

### 6.4.3 Sources

#### 6.4.3.1 Menu

**ACTUAL VALUES** ⇒ **↓ METERING** ⇒ **↓ SOURCE SRC 1**

<ul style="list-style-type: none"> <li>■ SOURCE SRC 1</li> </ul>	↔	<ul style="list-style-type: none"> <li>■ PHASE CURRENT</li> <li>■ SRC 1</li> </ul>	See below
	⇅	<ul style="list-style-type: none"> <li>■ GROUND CURRENT</li> <li>■ SRC 1</li> </ul>	See page 6-19
	⇅	<ul style="list-style-type: none"> <li>■ PHASE VOLTAGE</li> <li>■ SRC 1</li> </ul>	See page 6-19
	⇅	<ul style="list-style-type: none"> <li>■ AUXILIARY VOLTAGE</li> <li>■ SRC 1</li> </ul>	See page 6-20
	⇅	<ul style="list-style-type: none"> <li>■ POWER</li> <li>■ SRC 1</li> </ul>	See page 6-20
	⇅	<ul style="list-style-type: none"> <li>■ ENERGY</li> <li>■ SRC 1</li> </ul>	See page 6-21
	⇅	<ul style="list-style-type: none"> <li>■ FREQUENCY</li> <li>■ SRC 1</li> </ul>	See page 6-21
	⇅	<ul style="list-style-type: none"> <li>■ CURRENT HARMONICS</li> <li>■ SRC 1</li> </ul>	See page 6-22
	⇅	<ul style="list-style-type: none"> <li>■ VOLTAGE HARMONICS</li> <li>■ SRC 1</li> </ul>	See page 6-22

6

This menu displays the metered values available for each source.

Metered values presented for each source depend on the phase and auxiliary VTs and phase and ground CTs assignments for this particular source. For example, if no phase VT is assigned to this source, then any voltage, energy, and power values are unavailable.

#### 6.4.3.2 Phase current metering

**ACTUAL VALUES** ⇒ **↓ METERING** ⇒ **SOURCE SRC 1** ⇒ **PHASE CURRENT**

<ul style="list-style-type: none"> <li>■ PHASE CURRENT</li> <li>■ SRC 1</li> </ul>	↔	SRC 1 RMS Ia: 0.000 b: 0.000 c: 0.000 A
	⇅	SRC 1 RMS Ia: 0.000 A
	⇅	SRC 1 RMS Ib: 0.000 A
	⇅	SRC 1 RMS Ic: 0.000 A
	⇅	SRC 1 RMS In: 0.000 A
	⇅	SRC 1 PHASOR Ia: 0.000 A 0.0°
	⇅	SRC 1 PHASOR Ib: 0.000 A 0.0°

⇅	SRC 1 PHASOR Ic: 0.000 A 0.0°
⇅	SRC 1 PHASOR In: 0.000 A 0.0°
⇅	SRC 1 ZERO SEQ I0: 0.000 A 0.0°
⇅	SRC 1 POS SEQ I1: 0.000 A 0.0°
↑	SRC 1 NEG SEQ I2: 0.000 A 0.0°

The metered phase current values are displayed in this menu. The "SRC 1" text gets replaced by whatever name was programmed by the user for the associated source (see **SETTINGS** ⇒ **SYSTEM SETUP** ⇒ **SIGNAL SOURCES**).

### 6.4.3.3 Ground current metering

**ACTUAL VALUES** ⇒ **METERING** ⇒ **SOURCE SRC 1** ⇒ **GROUND CURRENT**

■ GROUND CURRENT ■ SRC 1	↔	SRC 1 RMS Ig: 0.000 A
	⇅	SRC 1 PHASOR Ig: 0.000 A 0.0°
	↑	SRC 1 PHASOR Igd: 0.000 A 0.0°

The metered ground current values are displayed in this menu. The "SRC 1" text is replaced by the name programmed by the user for the associated source (see **SETTINGS** ⇒ **SYSTEM SETUP** ⇒ **SIGNAL SOURCES**).

### 6.4.3.4 Phase voltage metering

**ACTUAL VALUES** ⇒ **METERING** ⇒ **SOURCE SRC 1** ⇒ **PHASE VOLTAGE**

■ PHASE VOLTAGE ■ SRC 1	↔	SRC 1 RMS Vag: 0.00 V
	⇅	SRC 1 RMS Vbg: 0.00 V
	⇅	SRC 1 RMS Vcg: 0.00 V
	⇅	SRC 1 PHASOR Vag: 0.000 V 0.0°
	⇅	SRC 1 PHASOR Vbg: 0.000 V 0.0°
	⇅	SRC 1 PHASOR Vcg: 0.000 V 0.0°
	⇅	SRC 1 RMS Vab: 0.00 V
	⇅	SRC 1 RMS Vbc: 0.00 V
	⇅	SRC 1 RMS Vca: 0.00 V
	⇅	SRC 1 PHASOR Vab: 0.000 V 0.0°

⇅	SRC 1 PHASOR Vbc: 0.000 V 0.0°
⇅	SRC 1 PHASOR Vca: 0.000 V 0.0°
⇅	SRC 1 ZERO SEQ V0: 0.000 V 0.0°
⇅	SRC 1 POS SEQ V1: 0.000 V 0.0°
↑	SRC 1 NEG SEQ V2: 0.000 V 0.0°

The metered phase voltage values are displayed in this menu. The "SRC 1" text is replaced by the name programmed by the user for the associated source (see **SETTINGS ⇒ METERING ⇒ SYSTEM SETUP ⇒ SIGNAL SOURCES**).

### 6.4.3.5 Auxiliary voltage metering

**ACTUAL VALUES ⇒ METERING ⇒ SOURCE SRC 1 ⇒ AUXILIARY VOLTAGE**

<ul style="list-style-type: none"> <li>■ AUXILIARY VOLTAGE</li> <li>■ SRC 1</li> </ul>	⇅	SRC 1 RMS Vx: 0.00 V
	↑	SRC 1 PHASOR Vx: 0.000 V 0.0°

The metered auxiliary voltage values are displayed in this menu. The "SRC 1" text is replaced by the name programmed by the user for the associated source (see **SETTINGS ⇒ METERING ⇒ SYSTEM SETUP ⇒ SIGNAL SOURCES**).

### 6.4.3.6 Power metering

**ACTUAL VALUES ⇒ METERING ⇒ SOURCE SRC 1 ⇒ POWER**

<ul style="list-style-type: none"> <li>■ POWER</li> <li>■ SRC 1</li> </ul>	⇅	SRC 1 REAL POWER 3φ: 0.000 W
	⇅	SRC 1 REAL POWER φa: 0.000 W
	⇅	SRC 1 REAL POWER φb: 0.000 W
	⇅	SRC 1 REAL POWER φc: 0.000 W
	⇅	SRC 1 REACTIVE PWR 3φ: 0.000 var
	⇅	SRC 1 REACTIVE PWR φa: 0.000 var
	⇅	SRC 1 REACTIVE PWR φb: 0.000 var
	⇅	SRC 1 REACTIVE PWR φc: 0.000 var
	⇅	SRC 1 APPARENT PWR 3φ: 0.000 VA
	⇅	SRC 1 APPARENT PWR φa: 0.000 VA
	⇅	SRC 1 APPARENT PWR φb: 0.000 VA

⇅	SRC 1 APPARENT PWR φc: 0.000 VA
⇅	SRC 1 POWER FACTOR 3φ: 1.000
⇅	SRC 1 POWER FACTOR φa: 1.000
⇅	SRC 1 POWER FACTOR φb: 1.000
↑	SRC 1 POWER FACTOR φc: 1.000

This menu displays metered values for real, reactive, and apparent power, as well as power factor. The "SRC 1" text is replaced by the name programmed by the user for the associated source (see **SETTINGS ⇒ ↓ SYSTEM SETUP ⇒ ↓ SIGNAL SOURCES**).

When VTs are configured in wye, the G30 calculates power in each phase and three-phase power is measured as

$$S = V_A \times \hat{I}_A + V_B \times \hat{I}_B + V_C \times \hat{I}_C \tag{Eq. 6-1}$$

When VTs are configured in delta, the G30 does not calculate power in each phase and three-phase power is measured as

$$S = V_{AB} \times \hat{I}_A + V_{CB} \times \hat{I}_C \tag{Eq. 6-2}$$

where

S is the apparent power

$V_A, V_B, V_C, I_A, I_B, I_C$  are phase voltage and phase current phasors

$V_{AB}$  and  $V_{CB}$  are phase-to-phase voltage phasors

$\hat{I}$  is the conjugate of I

### 6.4.3.7 Energy metering

ACTUAL VALUES ⇒ ↓ METERING ⇒ SOURCE SRC 1 ⇒ ↓ ENERGY

<input checked="" type="checkbox"/> ENERGY <input checked="" type="checkbox"/> SRC 1	↔	SRC 1 POS WATTHOUR: 0.000 Wh
	⇅	SRC 1 NEG WATTHOUR: 0.000 Wh
	⇅	SRC 1 POS VARHOUR: 0.000 varh
	↑	SRC 1 NEG VARHOUR: 0.000 varh

This menu displays metered values for real and reactive energy. The "SRC 1" text is replaced by the name programmed by the user for the associated source (see **SETTINGS ⇒ ↓ SYSTEM SETUP ⇒ ↓ SIGNAL SOURCES**). Because energy values are accumulated, record them and then reset them immediately prior to changing CT or VT characteristics.

### 6.4.3.8 Frequency metering

ACTUAL VALUES ⇒ ↓ METERING ⇒ SOURCE SRC 1 ⇒ ↓ FREQUENCY

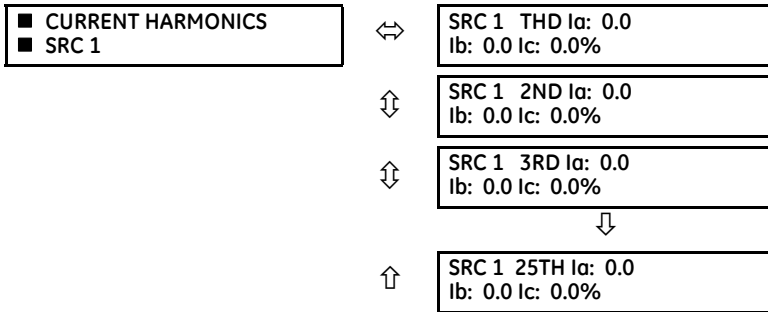
<input checked="" type="checkbox"/> FREQUENCY <input checked="" type="checkbox"/> SRC 1	↔	SRC 1 FREQUENCY: 0.00 Hz
--	---	-----------------------------

The metered frequency values are displayed in this menu. The "SRC 1" text is replaced by the name programmed by the user for the associated source (see **SETTINGS ⇒ ↓ SYSTEM SETUP ⇒ ↓ SIGNAL SOURCES**).

**SOURCE FREQUENCY** is measured via software-implemented zero-crossing detection of an AC signal. The signal is either a Clarke transformation of three-phase voltages or currents, auxiliary voltage, or ground current as per source configuration (see the **SYSTEM SETUP** ⇒ **POWER SYSTEM** settings). The signal used for frequency estimation is low-pass filtered. The final frequency measurement is passed through a validation filter that eliminates false readings due to signal distortions and transients.

### 6.4.3.9 Current harmonics and THD metering

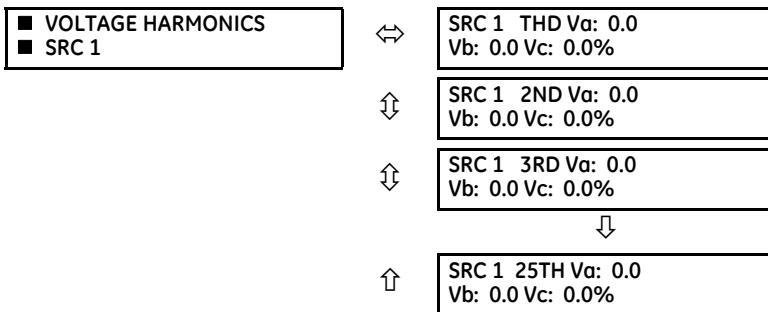
ACTUAL VALUES ⇒ METERING ⇒ SOURCE SRC 1 ⇒ CURRENT HARMONICS



This menu displays metered current harmonics values. The "SRC 1" text is replaced by the name was programmed for the associated source (see **SETTINGS** ⇒ **SYSTEM SETUP** ⇒ **SIGNAL SOURCES**). Current harmonics are measured for each source for the total harmonic distortion (THD) and 2nd to 25th harmonics per phase.

### 6.4.3.10 Voltage harmonics and THD metering

ACTUAL VALUES ⇒ METERING ⇒ SOURCE SRC 1 ⇒ VOLTAGE HARMONICS



This menu displays metered voltage harmonics values. The "SRC 1" text is replaced by the programmed name for the associated source (see the **SETTINGS** ⇒ **SYSTEM SETUP** ⇒ **SIGNAL SOURCES** menu).

To extract the 2nd to 25th voltage harmonics, each harmonic is computed on a per-phase basis, where:

$N = 64$  is the number of samples per cycle

$\omega_0 = 2\pi f$  is the angular frequency based on the system frequency (50 or 60 Hz)

$k = 1, 2, \dots, N - 1$  is the index over one cycle for the Fast Fourier Transform (FFT)

$m$  is the last sample number for the sliding window

$h = 1, 2, \dots, 25$  is the harmonic number

The short-time Fourier transform is applied to the unfiltered signal:

$$F_{\text{real}}(m, h) = \sum_k^N (f(m-k) \cdot \cos(h \cdot \omega_0 \cdot t(k)))$$

$$F_{\text{imag}}(m, h) = \sum_k^N (f(m-k) \cdot \sin(h \cdot \omega_0 \cdot t(k)))$$

$$F_{\text{ampl}}(m, h) = \sqrt{F_{\text{real}}(m, h)^2 + F_{\text{imag}}(m, h)^2}$$

Eq. 6-3

The harmonics are a percentage of the fundamental signal obtained as a ratio of harmonic amplitude to fundamental amplitude multiplied by 100%. The total harmonic distortion (THD) is the ratio of the total harmonic content to the fundamental:

$$THD = \sqrt{F_2^2 + F_3^2 + \dots + F_{25}^2}$$

Eq. 6-4



Voltage harmonics are calculated only for Wye connected phase VTs. Ensure that the **SYSTEM SETUP** ⇒ **AC INPUTS** ⇒ **VOLTAGE BANK F5** ⇒ **PHASE VT XX CONNECTION** setting is “Wye” to enable voltage harmonics metering.

### 6.4.4 Synchrocheck

ACTUAL VALUES ⇒ METERING ⇒ SYNCHROCHECK ⇒ SYNCHROCHECK 1(4)

■ SYNCHROCHECK 1 ■	↔	SYNCHROCHECK 1 DELTA VOLT: 0.000 kV
	↕	SYNCHROCHECK 1 DELTA FREQ: 0.00 Hz
	↕	SYNCHROCHECK 1 DELTA PHASE: 0.0°
	↕	SYNCHROCHECK 1 SYNSCP D_PH: 0.0°
	↕	SYNCHROCHECK 1 V1 MAG: 0.000 kv
	↕	SYNCHROCHECK 1 V1 ANG: 0.0°
	↕	SYNCHROCHECK 1 V2 MAG: 0.000 kV
	↕	SYNCHROCHECK 1 V2 ANG: 0.0°
	↕	SYNCHROCHECK 1 PROJ V2 MAG: 0.000 kV
	↕	SYNCHROCHECK 1 PROJ V2 ANG: 0.0°
	↕	SYNCHROCHECK 1 PROJ DELTA_PHASE: 0.0°
	↑	SYNCHROCHECK 1 PROJ SYNSCP D_PH: 0.0°

If synchrocheck or a setting is "Disabled," the corresponding actual values menu item does not display.

### 6.4.5 Tracking frequency

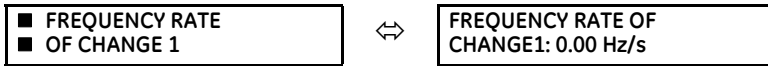
ACTUAL VALUES ⇒ METERING ⇒ TRACKING FREQUENCY

■ TRACKING FREQUENCY ■	↔	TRACKING FREQUENCY: 60.00 Hz
---------------------------	---	---------------------------------

The tracking frequency displays here. The frequency is tracked based on the selection of the reference source with the **FREQUENCY AND PHASE REFERENCE** setting in the **SETTINGS** ⇒ **SYSTEM SETUP** ⇒ **POWER SYSTEM** menu. See the Power System section of chapter 5 for details.

### 6.4.6 Frequency rate of change

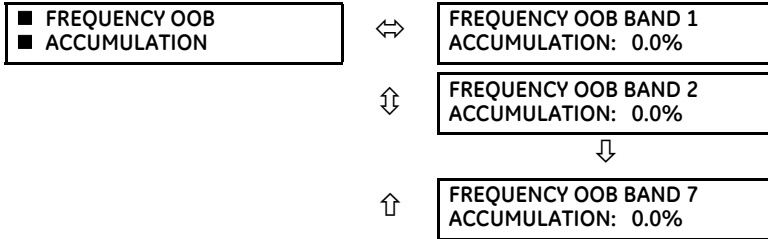
ACTUAL VALUES ⇨⇩ METERING ⇨⇩ FREQUENCY RATE OF CHANGE 1(4)



The metered frequency rate of change for the frequency rate of change elements is shown here.

### 6.4.7 Frequency out-of-band accumulation

ACTUAL VALUES ⇨⇩ METERING ⇨⇩ FREQUENCY OOB ACCUMULATION



The frequency out-of-band accumulation metered values are displayed to the nearest percent as a ratio of the present accumulation to the user-specified limit. Note that this value can be greater than 100%.

### 6.4.8 FlexElements

ACTUAL VALUES ⇨⇩ METERING ⇨⇩ FLEXELEMENTS ⇨ FLEXELEMENT 1(16)



The operating signals for the FlexElements are displayed in pu values using the following definitions of the base units.

Table 6-2: FlexElement base units

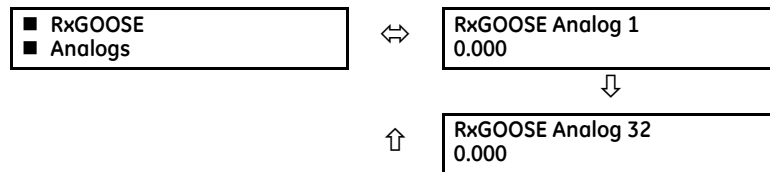
Base unit	Description
BREAKER ACC ARCING AMPS (Brk X Acc Arc Amp A, B, and C)	$B_{BASE} = 2000 \text{ kA}^2 \times \text{cycle}$
BREAKER ARCING AMPS (Brk X Arc Amp A, B, and C)	$B_{BASE} = 1 \text{ kA}^2 \times \text{cycle}$
DCmA	$B_{BASE} = \text{maximum value of the DCMA INPUT MAX setting for the two transducers configured under the +IN and -IN inputs.}$
FREQUENCY	$f_{BASE} = 1 \text{ Hz}$
FREQUENCY RATE OF CHANGE	$df/dt_{BASE} = 1 \text{ Hz/s}$
PHASE ANGLE	$\phi_{BASE} = 360 \text{ degrees (see the UR angle referencing convention)}$
POWER FACTOR	$PF_{BASE} = 1.00$
RTDs	$B_{BASE} = 100^\circ\text{C}$
SENSITIVE DIR POWER (Sns Dir Power)	$P_{BASE} = \text{maximum value of } 3 \times V_{BASE} \times I_{BASE} \text{ for the +IN and -IN inputs of the sources configured for the sensitive power directional element(s).}$
SOURCE CURRENT	$I_{BASE} = \text{maximum nominal primary RMS value of the +IN and -IN inputs}$
SOURCE ENERGY (Positive and Negative Watthours, Positive and Negative Varhours)	$E_{BASE} = 10000 \text{ MWh or MVAh, respectively}$
SOURCE POWER	$P_{BASE} = \text{maximum value of } V_{BASE} \times I_{BASE} \text{ for the +IN and -IN inputs}$
SOURCE THD & HARMONICS	$B_{BASE} = 1\%$
SOURCE VOLTAGE	$V_{BASE} = \text{maximum nominal primary RMS value of the +IN and -IN inputs}$



Base unit	Description
STATOR GROUND 3RD HARMONIC VOLTAGES (Stator Gnd Vn/V0 3rd)	$V_{BASE}$ = Primary auxiliary voltage of the <b>STATOR GROUND SOURCE</b>
SYNCHROCHECK (Max Delta Volts)	$V_{BASE}$ = maximum primary RMS value of all the sources related to the +IN and -IN inputs
VOLTS PER HERTZ	BASE = 1.00 pu
XFMR DIFFERENTIAL CURRENT (Xfmr Iad, Ibd, and Icd Mag)	$I_{BASE}$ = maximum primary RMS value of the +IN and -IN inputs (CT primary for source currents, and transformer reference primary current for transformer differential currents)
XFMR DIFFERENTIAL HARMONIC CONTENT (Xfmr Harm2 Iad, Ibd, and Icd Mag) (Xfmr Harm5 Iad, Ibd, and Icd Mag)	BASE = 100%
XFMR RESTRAINING CURRENT (Xfmr Iar, Ibr, and Icr Mag)	$I_{BASE}$ = maximum primary RMS value of the +IN and -IN inputs (CT primary for source currents, and transformer reference primary current for transformer differential currents)

### 6.4.9 RxGOOSE analogs

ACTUAL VALUES ⇌ METERING ⇌ RxGOOSE Analogs



The G30 is provided with optional GOOSE communications capability. This feature is specified as a software option at the time of ordering. See the Order Codes section of chapter 2 for details.

The RxGOOSE Analog values display in this menu. The RxGOOSE Analog values are received via IEC 61850 GOOSE messages sent from other devices.

### 6.4.10 Sensitive directional power

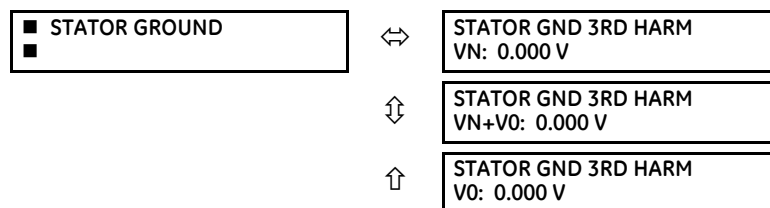
ACTUAL VALUES ⇌ METERING ⇌ SENSITIVE DIRECTIONAL POWER ⇌ DIRECTIONAL POWER 1(2)



The effective operating quantities of the sensitive directional power elements display here. The display is useful to calibrate the feature by compensating the angular errors of the CTs and VTs with the use of the **RCA** and **CALIBRATION** settings.

### 6.4.11 Stator ground

ACTUAL VALUES ⇌ METERING ⇌ STATOR GROUND



Magnitudes of the third harmonic components of the machine neutral point voltage (VN), the zero-sequence voltage at the machine terminals (V0), and in the vector sum of the neutral point voltage and zero-sequence voltage (VN + V0) are available for display. The values are calculated for a signal source specified under the **STATOR GROUND** settings menu.

These readings can be useful when selecting a pickup and supervision setting for the third harmonic neutral undervoltage protection element.

### 6.4.12 Volts per hertz

ACTUAL VALUES ⇒ METERING ⇒ VOLTS PER HERTZ 1(2)

<ul style="list-style-type: none"> <li>■ VOLTS PER HERTZ 1</li> <li>■</li> </ul>	↔	VOLTS PER HERTZ 1: 0.000 pu
--	---	--------------------------------

This menu displays the data for volts per hertz.

### 6.4.13 Restricted ground fault

ACTUAL VALUES ⇒ METERING ⇒ RESTRICTED GROUND FAULT CURRENTS ⇒ RESTRICTED GROUND FAULT 1(4)

<ul style="list-style-type: none"> <li>■ RESTRICTED</li> <li>■ GROUND FAULT 1</li> </ul>	↔	RGF 1 DIFF Igd: 0.000 A
	↑	RGF 1 RESTR Igr: 0.000 A

This menu displays the differential and restraint current values for the restricted ground fault element.

### 6.4.14 Transducer inputs and outputs

ACTUAL VALUES ⇒ METERING ⇒ TRANSDUCER I/O DCMA INPUTS ⇒ DCMA INPUT xx

<ul style="list-style-type: none"> <li>■ DCMA INPUT xx</li> <li>■</li> </ul>	↔	DCMA INPUT xx 0.000 mA
--	---	---------------------------

Actual values for each DCmA input channel that is enabled are displayed with the top line as the programmed channel ID and the bottom line as the value followed by the programmed units.

ACTUAL VALUES ⇒ METERING ⇒ TRANSDUCER I/O RTD INPUTS ⇒ RTD INPUT xx

<ul style="list-style-type: none"> <li>■ RTD INPUT xx</li> <li>■</li> </ul>	↔	RTD INPUT xx -50 °C
---	---	------------------------

Actual values for each RTD input channel that is enabled are displayed with the top line as the programmed channel ID and the bottom line as the value.

## 6.5 Records

### 6.5.1 User-programmable fault reports

ACTUAL VALUES ⇒ RECORDS ⇒ USER-PROGRAMMABLE FAULT REPORTS

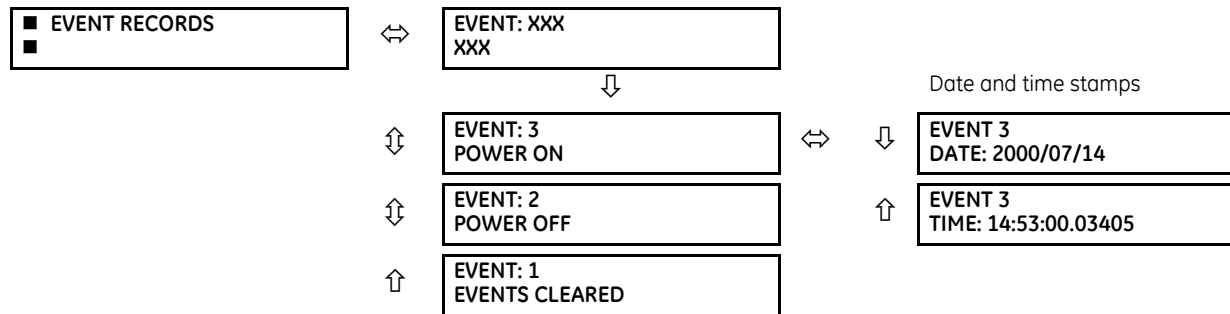
<ul style="list-style-type: none"> <li>■ USER-PROGRAMMABLE</li> <li>■ FAULT REPORTS</li> </ul>	↔	NEWEST RECORD NUMBER: 0
	↑	LAST CLEARED DATE: 2002/8/11 14:23:57
	↑	LAST REPORT DATE: 2002/10/09 08:25:27

This menu displays the user-programmable fault report actual values. See the User-Programmable Fault Report section in chapter 5 for information on this feature.

## 6.5.2 Event records

### 6.5.2.1 Enhanced and basic front panels

ACTUAL VALUES ⇄ RECORDS ⇄ EVENT RECORDS



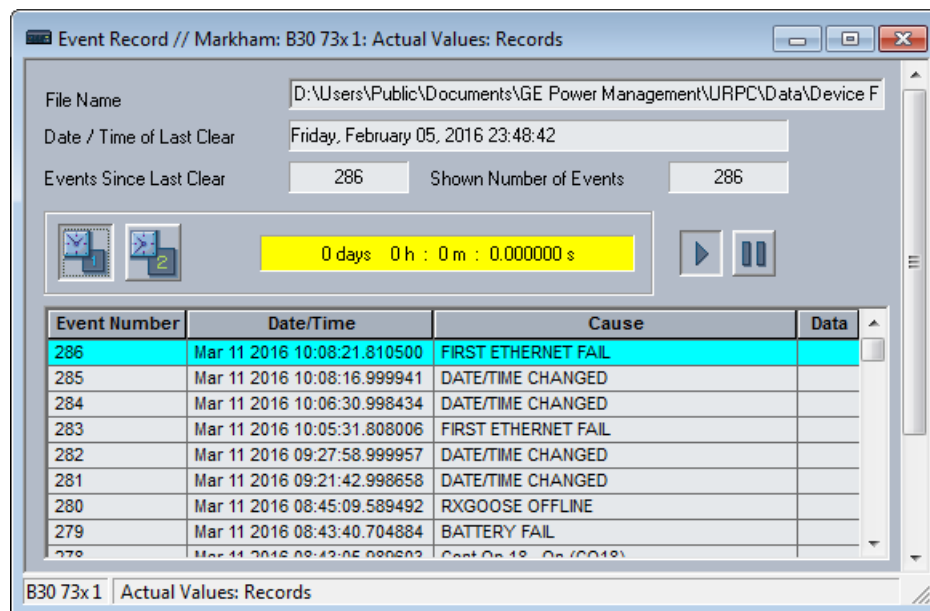
The event records menu shows the contextual data associated with up to the last 1024 events, listed in chronological order from most recent to oldest. When all 1024 event records have been filled, the oldest record is removed as a new record is added. Each event record shows the event identifier/sequence number, cause, and date/time stamp associated with the event trigger. See the **COMMANDS ⇄ CLEAR RECORDS** menu for clearing event records.

Only major output operands generate events, not every operand. Elements that assert output per phase, for example, log operating phase output only without asserting the common three-phase operand event.

See also the system log (syslog) information in the previous chapter.

The event records are viewable in the software and in a web browser. The figure shows the event records in the software.

Figure 6-6: Event records viewed in EnerVista software



To view events in a web browser:

1. Enter the IP address of the device.

To download an oscillography waveform:

1. Click the arrow icon in the **Data** column.

### 6.5.2.2 Graphical front panel

To display the event records page, press the **Home** pushbutton then the **Event Record** Tab pushbutton.

The newest event is always at the top.

Up and Down pushbuttons move the event selector up and down. When the selector is at the bottom of the display, the Down pushbutton also scrolls the page, and similarly when the active selector is at the top of the display the Up pushbutton scroll the page.

A selected event is highlighted in yellow and becomes active by pressing the Up or Down pushbutton.

There are two event markers, one green, the other cyan. To mark some an event, use the Up and Down pushbuttons to select it (highlight in yellow), then press the green or cyan Mark Event Tab pushbutton. The mark color hides the selector until the selector is moved. A field at the top of the page shows the interval between the two marks.

Figure 6-7: Event record

Event Record		29-Jun-17 11:56:33 AM
Most recent event number	38	Time between marks 0d 0h : 0m : 35.012364s
Event ID	Date/Time	Cause
38	29-Jun-17 10:17:56.117582	WRONG TRANSCEIVER
37	29-Jun-17 10:17:56.117582	POWER ON
36	29-Jun-17 10:17:21.105218	POWER OFF
35	29-Jun-17 10:17:21.105218	REBOOT COMMAND
34	29-Jun-17 10:01:41.074062	FLASH PROGRAMMING
33	29-Jun-17 09:49:33.711569	RESET ANCTR OP(MNUL)
32	29-Jun-17 09:49:12.946980	RESET ANCTR OP(MNUL)
31	29-Jun-17 09:47:51.344902	RESET ANCTR OP(MNUL)
30	29-Jun-17 09:41:34.117044	WRONG TRANSCEIVER
29	29-Jun-17 09:41:34.117044	POWER ON
Mark Event	Mark Event	Page Up Page Down

## 6.5.3 Oscillography

### 6.5.3.1 Enhanced and basic front panels

ACTUAL VALUES ⇄ RECORDS ⇄ OSCILLOGRAPHY

OSCILLOGRAPHY

⇄

FORCE TRIGGER?  
No

Range: No, Yes

⇄

NUMBER OF TRIGGERS:  
0

⇄

AVAILABLE RECORDS:  
0

⇄

CYCLES PER RECORD:  
0

⇄

LAST CLEARED DATE:  
2000/07/14 15:40:16

This menu allows the user to view the number of triggers involved and number of oscillography traces available. The cycles per record value is calculated to account for the fixed amount of data storage for oscillography. See the Oscillography section of chapter 5 for details.

A trigger can be forced here at any time by setting “Yes” to the FORCE TRIGGER? command. See the **COMMANDS ⇄ CLEAR RECORDS** menu for information on clearing the oscillography records.

To view a waveform:

2. Access **Actual Values > Records > Oscillography** in the EnerVista software.
3. In the window that opens, select the record number. The highest number is the most recent record (Newest Record Number).
4. Click the **Read** button to get the waveform. When available, waveforms are displayed graphically, and otherwise error messages display.
5. In the waveform window that opens, you can save the file, for example with the CFG extension.

## 6.5.4 Data logger

ACTUAL VALUES ⇌ RECORDS ⇌ DATA LOGGER

■ DATA LOGGER ■	↔	OLDEST SAMPLE TIME: 2000/01/14 13:45:51
	↑	NEWEST SAMPLE TIME: 2000/01/14 15:21:19

The **OLDEST SAMPLE TIME** represents the time at which the oldest available samples were taken. It is static until the log gets full, at which time it starts counting at the defined sampling rate.

The **NEWEST SAMPLE TIME** represents the time the most recent samples were taken. It counts up at the defined sampling rate. If the data logger channels are defined, then both values are static.

See the **COMMANDS ⇌ CLEAR RECORDS** menu for clearing data logger records.

## 6.5.5 Breaker maintenance

ACTUAL VALUES ⇌ RECORDS ⇌ MAINTENANCE ⇌ BREAKER 1(2)

■ BREAKER 1 ■	↔	BKR 1 ACC ARCING AMP φA: 0.00 kA2-cyc
	↕	BKR 1 ACC ARCING AMP φB: 0.00 kA2-cyc
	↕	BKR 1 ACC ARCING AMP φC: 0.00 kA2-cyc
	↕	BKR 1 OPERATING TIME φA: 0 ms
	↕	BKR 1 OPERATING TIME φB: 0 ms
	↕	BKR 1 OPERATING TIME φC: 0 ms
	↕	BKR 1 OPERATING TIME: 0 ms
	↕	BKR 1 ARCING AMP φA: 0.00 kA2-cyc
	↕	BKR 1 ARCING AMP φB: 0.00 kA2-cyc
	↑	BKR 1 ARCING AMP φC: 0.00 kA2-cyc
	↑	BKR 1 AMP MAX φA: 0.00 kA
	↑	BKR 1 AMP MAX φB: 0.00 kA

↑ BKR 1 AMP MAX  $\phi$ C:  
0.00 kA

There is an identical menu for each of the breakers.

The **BKR 1 ACC ARCING AMP** values are in units of kA<sup>2</sup>-cycles. See the **COMMANDS** ⇒⇅ **CLEAR RECORDS** menu for clearing breaker arcing current records.

The **BREAKER OPERATING TIME** is defined as the slowest operating time of breaker poles that were initiated to open.

All of the values are stored in non-volatile memory and retained with power cycling.

## 6.6 Product information

### 6.6.1 Model information

ACTUAL VALUES ⇒⇅ PRODUCT INFO ⇒ MODEL INFORMATION

■ MODEL INFORMATION ■	⇅	ORDER CODE LINE 1: G30-A00-AAA-A0A-A0A-	Range: standard GE order code format
	⇅	ORDER CODE LINE 2: A0A-A0A-A0A	Range: up to 20 alphanumeric characters
	⇅	ORDER CODE LINE 3:	Range: up to 20 alphanumeric characters
	⇅	ORDER CODE LINE 4:	Range: up to 20 alphanumeric characters
	⇅	SERIAL NUMBER:	Range: standard GE serial number format
	⇅	ETHERNET MAC ADDRESS 000000000000	Range: standard Ethernet MAC address format
	⇅	MANUFACTURING DATE:	Range: YYYY/MM/DD HH:MM:SS
	⇅	OPERATING TIME: 0:00:00	Range: operating time in HH:MM:SS
	⇅	CT/ VT ADVANCED DIAG ACTIVE: No	Range: Yes, No
	↑	LAST SETTING CHANGE: 1970/01/01 23:11:19	Range: YYYY/MM/DD HH:MM:SS

The order code, serial number, Ethernet MAC address, date and time of manufacture, and operating time are shown here. The rear panel on the device contains similar information. The information is read-only in the software and modifiable on the front panel. For example, the order code can be corrected using the front panel.

**ETHERNET MAC ADDRESS** — UR devices with firmware 7.0x and above have three Ethernet ports that can be used on three networks. The MAC address displays for port 1. The MAC address for port 2 is one higher. The MAC address for port 3 is one higher than port 2. In redundant mode, the MAC addresses for ports 2 and 3 are the same as port 2.

## 6.6.2 Firmware revisions

### 6.6.2.1 Enhanced and basic front panels

#### ACTUAL VALUES ⇌ PRODUCT INFO ⇌ FIRMWARE REVISIONS

<div style="border: 1px solid black; padding: 2px;"> <p>■ FIRMWARE REVISIONS</p> <p>■</p> </div>	↔	G30 Relay REVISION: 7.6x	Range: 0.00 to 655.35 Revision number of the application firmware.
	↕	MODIFICATION FILE NUMBER: 0	Range: 0 to 65535 (ID of the MOD FILE) Value is 0 for each standard firmware release.
	↕	BOOT PROGRAM REVISION: 7.01	Range: 0.00 to 655.35 Revision number of the boot program firmware.
	↕	FRONT PANEL PROGRAM REVISION: 2.01	Range: 0.00 to 655.35 Revision number of front panel program firmware.
	↕	COMPILE DATE: 2016/09/15 04:55:16	Range: YYYY/MM/DD HH:MM:SS Date and time when product firmware was built.
	↕	BOOT DATE: 2013/09/15 16:41:32	Range: YYYY/MM/DD HH:MM:SS Date and time when the boot program was built.
	↕	FPGA PROGRAM REVISION: 02.02	Range: 0.00 to 655.35 Revision number for FPGA.
	↑	FPGA DATE: 2016/09/15 16:41:32	Range: YYYY/MM/DD HH:MM:SS Date and time when the FPGA was built.

The shown data is illustrative only. A modification file number of 0 indicates that, currently, no modifications have been installed.

### 6.6.2.2 Graphical front panel

#### ACTUAL VALUES ⇌ PRODUCT INFO ⇌ FIRMWARE REVISIONS

<div style="border: 1px solid black; padding: 2px;"> <p>■ FIRMWARE REVISIONS</p> <p>■</p> </div>	↔	G30 Relay REVISION: 7.6x	Range: 0.00 to 655.35 Revision number of the application firmware.
	↕	MODIFICATION FILE NUMBER: 0	Range: 0 to 65535 (ID of the MOD FILE) Value is 0 for each standard firmware release.
	↕	BOOT PROGRAM REVISION: 7.01	Range: 0.00 to 655.35 Revision number of the boot program firmware.
	↕	COMPILE DATE: 2017/06/15 04:55:16	Range: YYYY/MM/DD HH:MM:SS Date and time when product firmware was built.
	↕	BOOT DATE: 2016/09/15 16:41:32	Range: YYYY/MM/DD HH:MM:SS Date and time when the boot program was built.
	↕	GFP PROGRAM REVISION: 7.60	Range: 0.00 to 655.35 Revision number of front panel program firmware.
	↕	GFP COMPILE DATE: 2017/03/03 12:58:00	Range: YYYY/MM/DD HH:MM:SS Date/time when graphical front panel firmware built.
	↕	GFP BOOT PROGRAM REVISION: 1.00	Range: 0.00 to 655.35 Revision number of panel boot program firmware.
	↕	GFP BOOT COMP. DATE: 2017/03/03 12:58:00	Range: YYYY/MM/DD HH:MM:SS Date/time when panel boot program was built.
	↕	FPGA PROGRAM REVISION: 02.02	Range: 0.00 to 655.35 Revision number for FPGA.
↑	FPGA DATE: 2016/09/15 16:41:32	Range: YYYY/MM/DD HH:MM:SS Date and time when the FPGA was built.	

The shown data is illustrative only. A modification file number of 0 indicates that, currently, no modifications have been installed. The date format reflects the format specified for the clock and can vary from that shown here.

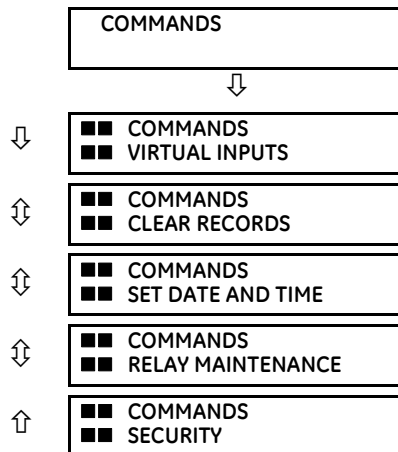


# G30 Generator Protection System

## Chapter 7: Commands and targets

This chapter outlines the Commands and Targets menus and self-tests/error messages. Commands related to the IEC 61850 protocol are outlined in the IEC 61850 section of the Settings chapter. Log/error messages for IEC 61850 are outlined in the UR Family Communications Guide.

### 7.1 Commands menu

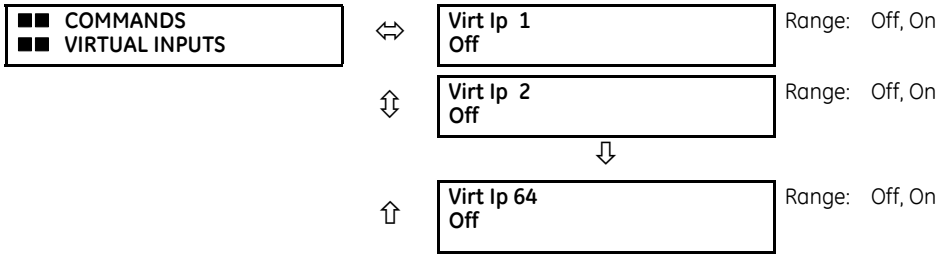


The commands menu contains relay directives intended for operations personnel. All commands can be protected from unauthorized access via the command password; see the Security section of chapter 5 for details. The following flash message appears after successfully command entry.

COMMAND  
EXECUTED

### 7.1.1 Virtual inputs

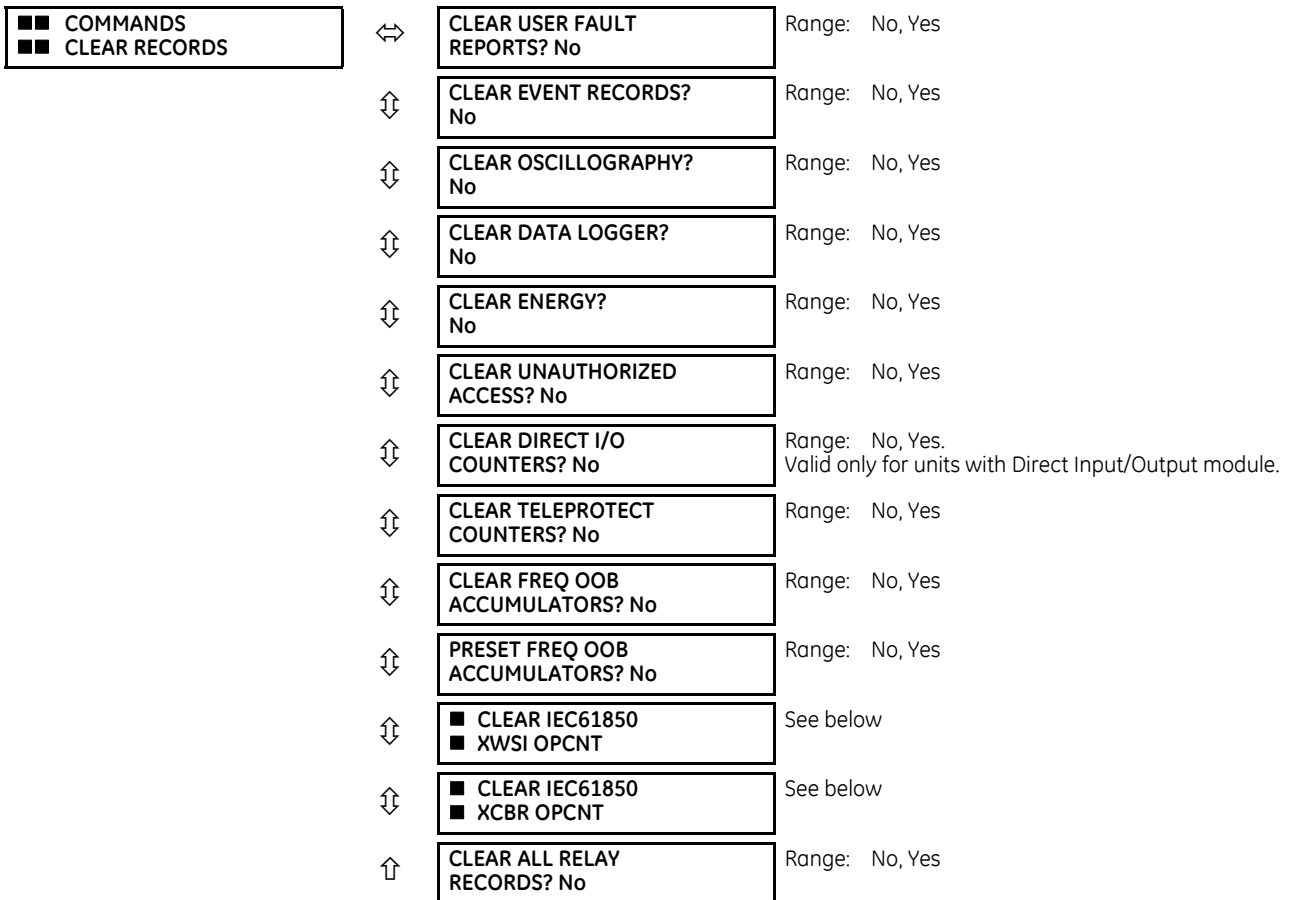
COMMANDS ⇌ VIRTUAL INPUTS



The states of up to 64 virtual inputs are changed here. The first line of the display indicates the ID of the virtual input. The second line indicates the current or selected status of the virtual input. This status is a state off (logic 0) or on (logic 1).

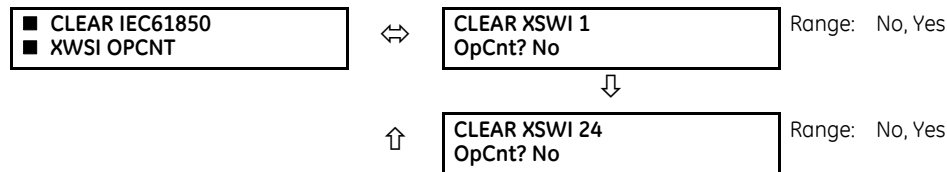
### 7.1.2 Clear records

COMMANDS ⇌ CLEAR RECORDS

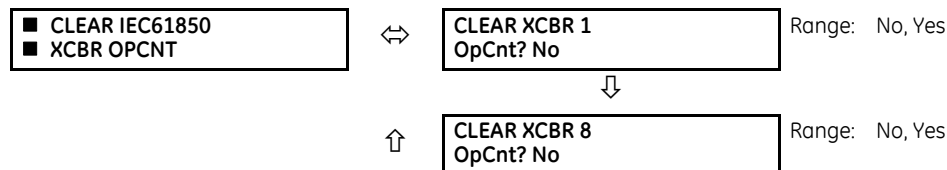


This menu contains commands for clearing historical data such as the event records. Data is cleared by changing a command setting to “Yes” and pressing the **ENTER** key. After clearing data, the command setting automatically reverts to “No.”

## COMMANDS ⇒ CLEAR RECORDS ⇒ CLEAR IEC61850 XWSI OPCNT



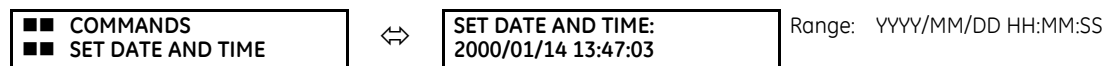
## COMMANDS ⇒ CLEAR RECORDS ⇒ CLEAR IEC61850 XCBR OPCNT



The Clear XSWI commands clear the disconnect operation counters for each phase and the three-phase counter. Similarly, the Clear XCBR commands clear the circuit breaker operation counters for each phase and the three-phase counter.

### 7.1.3 Set date and time

## COMMANDS ⇒ SET DATE AND TIME



The date and time can be entered on the front panel keypad. The time setting is based on the 24-hour clock. The complete date, as a minimum, must be entered to allow execution of this command. The new time and date take effect when the **ENTER** key is pressed.

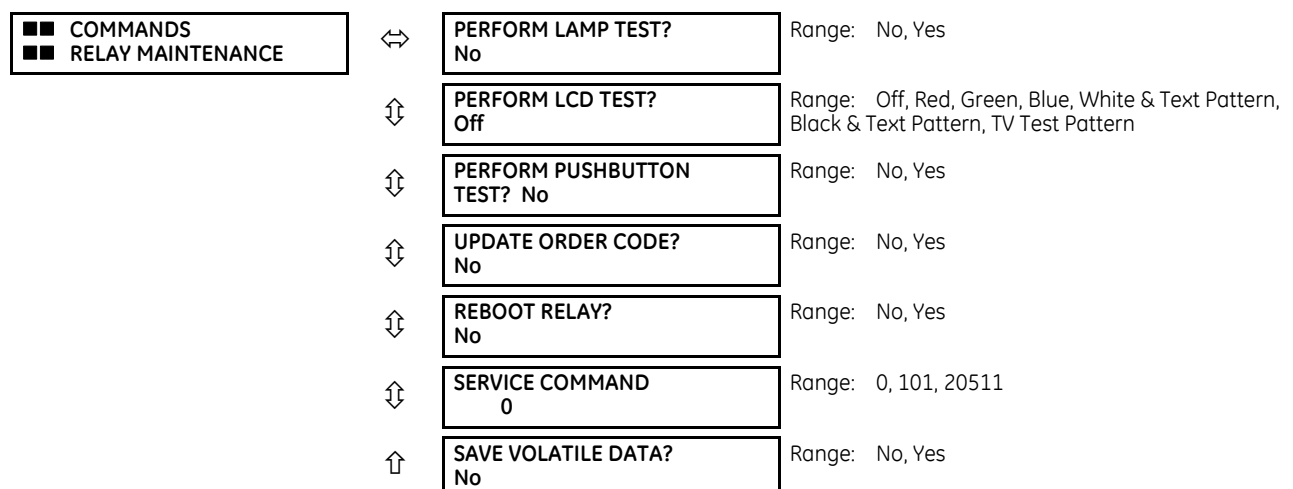
The clock also can be synchronized to the local computer time among several UR devices. Use the **Synchronize Devices** entry in the Online Window area of the EnerVista software. (Click the button at the top of the window that opens.)

When the relay is synchronizing to an external time source such as PTP, IRIG-B, or SNTP, the manually entered time or the manually synchronized time is over-written.

The timescale of the entered time is local time, including daylight savings time where and when applicable.

### 7.1.4 Relay maintenance

## COMMANDS ⇒ RELAY MAINTENANCE



This menu contains commands for relay maintenance purposes. Commands for the lamp test and order code are activated by changing a command setting to “Yes” and pressing the **ENTER** key. The command setting then automatically reverts to “No.” The service command is activated by entering a numerical code and pressing the **ENTER** key.

Not all commands display in the software; use the front panel when required.

**PERFORM LAMP TEST** — Turns on all front panel LEDs and display pixels for a short duration.

**PERFORM LCD TEST** — This command detects either stuck-ON or stuck-OFF pixels (dead pixels) in the display screen on the graphical front panel. RED/GREEN/BLUE is to display the solid background color in the whole screen. WHITE & TEXT PATTERN shows the white background and black texts. BLACK & TEXT PATTERN shows the black background and white texts. TV TEST PATTERN displays a standard television test pattern (SMPTE color bars). The test screen can be canceled by pressing any pushbutton or after 30 seconds of inactivity.

**PERFORM PUSHBUTTON TEST** — This command tests the pushbuttons on the graphical front panel. During testing, press the corresponding pushbutton according to the prompt text. A failure message is given if the expected action is not detected in one minute. Holding the **ESCAPE** button for five seconds to interrupt the test sequence. The designated function of a specific pushbutton is bypassed in the test.

**UPDATE ORDER CODE** — Use this command to read and update the order code, for example when hardware modules have been changed inside the relay. It causes the relay to scan the backplane for the modules and update the order code to match. All settings are defaulted with an update. When an update occurs, the following message displays and the relay restarts.



There is no impact if there have been no changes to the hardware modules. When an update does not occur, the ORDER CODE NOT UPDATED message displays.

**REBOOT RELAY** — Restarts the relay so that changes to configuration settings can take effect. In most cases, if changes are made to the configuration settings these changes do not take effect unless the relay is rebooted.



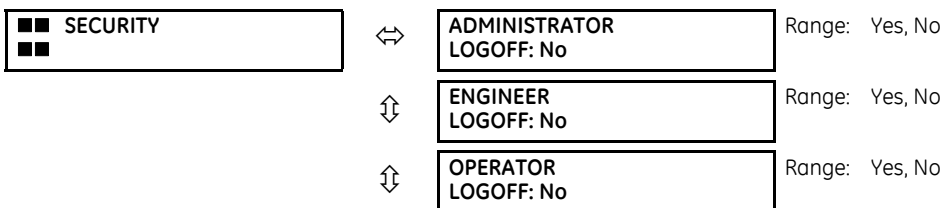
With the CyberSentry option, the Administrator and Operator roles can initiate the Reboot Relay command.

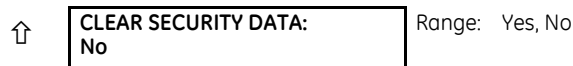
**SERVICE COMMAND** — Performs specific G30 service actions. Presently, there are two service actions available. Code “20511” returns all settings to their factory default value and restarts the relay (then you re-enter IP address, restart, set unit to “Programmed”). Code “101” is used to clear factory diagnostic information stored in the non-volatile memory. If a code other than these two is entered, the command is ignored and no action is taken. Various self-checking diagnostics are performed in the background while the G30 is running, and diagnostic information is stored on the non-volatile memory from time to time based on the self-checking result. Although the diagnostic information is cleared before the G30 is shipped from the factory, the user can want to clear the diagnostic information for themselves under certain circumstances. For example, you clear diagnostic information after replacement of hardware. Once the diagnostic information is cleared, all self-checking variables are reset to their initial state and diagnostics restart from scratch.

**SAVE VOLATILE DATA** — Saves this data to compact flash memory prior to shutdown. This allows the saved data to be as recent as possible instead of relying on the periodic timer to save the data.

### 7.1.5 Security

#### COMMANDS ⇌ SECURITY





With the CyberSentry option, this setting is available to enable or disable the following commands.

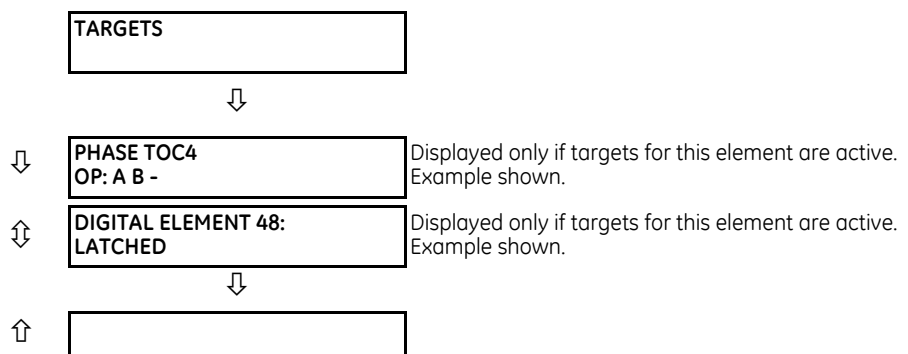
**ADMINISTRATOR LOGOFF** — Selecting 'Yes' allows the Supervisor to forcefully logoff an administrator session.

**ENGINEER LOGOFF** — Selecting 'Yes' allows the Supervisor to forcefully logoff an engineer session.

**OPERATOR LOGOFF** — Selecting 'Yes' allows the Supervisor to forcefully logoff an operator session.

**CLEAR SECURITY DATA** — Selecting 'Yes' allows the Supervisor to forcefully clear all the security logs and clears all the operands associated with the self-tests.

## 7.2 Targets menu



A target enables the EnerVista UR Setup software to monitor automatically and display the status of any active target messages of all the devices inserted into that site.

Each G30 element with a TARGET setting has a target message that when activated by its element is displayed in sequence with any other currently active target messages in the **TARGETS** menu. In the example shown, the Phase TOC4 and Digital Element 48 target settings are active and so have their targets displayed. The down arrow below the two elements indicates that there can be other active elements beyond these two.

For more information, see the description of target messages in the next section, and the Introduction to Elements section in the Settings chapter for instructions on TARGET setting.

When no targets are active, the display reads **NO ACTIVE TARGETS**.

### 7.2.1 Target messages

When there are no active targets, the first target to become active causes the display to immediately default to that message. If there are active targets and the user is navigating through other messages, and when the default message timer times out (i.e. the keypad has not been used for a determined period of time), the display again defaults back to the target message.

The range of variables for the target messages is described below. Phase information is included if applicable. If a target message status changes, the status with the highest priority displays.

**Table 7-1: Target message priority status**

Priority	Active status	Description
1	OP	element operated and still picked up
2	PKP	element picked up and timed out
3	LATCHED	element had operated but has dropped out

If a self test error is detected, a message appears indicating the cause of the error. For example UNIT NOT PROGRAMMED indicates that the minimal relay settings have not been programmed.

## 7.2.2 Relay self-tests

### 7.2.2.1 Description

The relay performs a number of self-test diagnostic checks to ensure device integrity. The two types of self-tests (major and minor) are listed in the following tables. When either type of error occurs, the Trouble LED Indicator turns on and a target message displays. All errors record an event in the event recorder. Latched errors can be cleared by pressing the **RESET** key, providing the condition is no longer present.

Major self-test errors also result in the following:

- The critical fail relay on the power supply module de-energizes
- All other output relays de-energize and are prevented from further operation
- The front panel In Service LED indicator turns off
- A RELAY OUT OF SERVICE event is recorded

To view error messages in EnerVista software:

1. Access **Actual Values > Records > Event Records**.

Messages display on the front panel with one or two lines of text. An example is as follows. In the tables that follow, messages are grouped using the first line of text. For example, MAINTENANCE ALERT, then a row for 4L Discrepancy, then a row for Bad IRIG-B Signal.

MAINTENANCE ALERT: 4L Discrepancy
--------------------------------------

MAINTENANCE ALERT: Bad IRIG-B Signal
---

### 7.2.2.2 Major self-test error messages

The major self-test errors are outlined in this section.

**Table 7-2: Major self-test errors**

Error	Latched?	Description	Test frequency	Action
DIAGNOSTIC FAILURE ____: Self Test Error	No	Internal recovery failure detected	Upon recovery	Extract a Service Report through UR Setup software. Contact technical support and supply details of the failure code on the display.
EQUIPMENT MISMATCH: <i>2nd line detail</i>	No	The number or type of installed hardware modules does not match the order code stored in the G30. An example is when a basic front panel is installed and the order code on the G30 expects a graphical front panel.	On power up. Afterwards, the backplane is checked for missing cards every five seconds	Check all modules against the order code, ensure they are inserted properly, and cycle control power. If a module has intentionally been added or removed, refresh the order code under <b>Device Setup</b> . If the problem persists, contact the factory.

Error	Latched?	Description	Test frequency	Action
FLEXLOGIC ERROR: <i>2nd line detail</i>	No	A FlexLogic equation is incorrect	Event driven, performed whenever FlexLogic equations are modified	Finish all equation editing and use self tests to debug any errors.
RAM FILESYSTEM FAIL: Self-Test Error	Yes	The relay failed to create the RAM file system	On relay startup	Contact factory service
SYSTEM FAILURE ____: <i>2nd line detail</i>	Yes	Relay system failure detected	Continuous	Extract a Service Report through UR Setup software. Contact technical support and supply details of the failure code on the display.
SYSTEM FAILURE: Card F8L	Yes	This is an indication that the DSP module has failed. The slot and DSP type are indicated in the message.		The recommendation is to replace this DSP. Extract a Service Report through UR Setup software and provide it to GE customer service.
TO INSTALL SETTINGS: CHECK LOG AND REBOOT	Yes	Certain settings require a reboot to be applied, for example DNP settings, IEC 104 settings. After a CID file was send to the relay, a manual reboot of the relay is required to apply those settings that require a reboot	A new CID is sent and it includes changes in settings that require a reboot to be applied	Restart relay
UNIT NOT PROGRAMMED: Check Settings	No	The <b>PRODUCT SETUP ⇒ ↓ INSTALLATION ⇒ RELAY SETTINGS</b> setting indicates the G30 is not programmed	On power up and whenever the <b>PRODUCT SETUP ⇒ ↓ INSTALLATION ⇒ RELAY SETTINGS</b> setting is altered	Program all settings and then set <b>PRODUCT SETUP ⇒ ↓ INSTALLATION ⇒ RELAY SETTINGS</b> to “Programmed”

### 7.2.2.3 Minor self-test error messages

Most of the minor self-test errors can be disabled. See the settings in the User-programmable Self-tests section in chapter 5.

Table 7-3: Minor self-test errors

Error	Latched?	Description	Test frequency	Action
DIAGNOSTIC ALARM COP: Self-test Error	Yes	This is a preliminary warning that transient errors were detected in the coprocessor. The relay remains operational but some elements can operate slightly delayed.		Extract a Service Report through UR Setup software and provide it to GE customer service
DIAGNOSTIC ALARM DSP: Card F8L	Yes	This is a preliminary warning that there is something wrong with a DSP. The slot and DSP type is indicated in the message.		Extract a Service Report through UR Setup software and provide it to GE customer service

Error	Latched?	Description	Test frequency	Action
DIAGNOSTICS FAILURE	Yes	This is a warning that there is something wrong with the DSP/coprocessor subsystem. The source of the problem is unknown as there are multiple contributors.		Extract a Service Report through UR Setup software and provide it to GE customer service
DIRECT DEVICE OFF: COMM Path Incomplete	No	A direct device is configured but not connected	Every second	Check direct input and output configuration and wiring
DOS PARTITION ALARM: SELF-TEST ERROR		There is a problem with the Compact Flash memory in the CPU module	On relay power-up and afterwards once every 24 hours	Contact the factory
LOW ON MEMORY: <i>with 2nd line detail</i>	Yes	The relay periodically checks the amount of free RAM memory available and the amount of free stack available for each task against pre-defined thresholds. The second line of the self-test indicates which of the tests failed. It asserts this self-test if those tests fail.	Every five seconds	Contact the factory
MAINTENANCE ALERT: 4L Discrepancy	No	A discrepancy has been detected between the actual and desired state of a latching contact output of an installed type "4L" module	Upon initiation of a contact output state change	Verify the state of the output contact and contact the factory if the problem persists
Bad IRIG-B Signal	No	A bad IRIG-B input signal has been detected	Monitored whenever an IRIG-B signal is received	Ensure the following: - The IRIG-B cable is properly connected. - Proper cable functionality (that is, check for physical damage or perform a continuity test). - The IRIG-B receiver is functioning. - Check the input signal level (it can be less than specification). If none of these apply, then contact the factory.
Bad PTP Signal	No	No PTP enabled port has good PTP signal input	Activated when no acceptable signal is being received	Ensure the following: - The Ethernet cable(s) are properly connected. - At least one PTP grandmaster-capable clock is functioning. - If strict PP is enabled, that entire network is PP compliant. - The network is delivering PTP messages to the relay.
Direct Ring Break	No	Direct input and output settings are configured for a ring, but the connection is not in a ring	Every second	Check direct input and output configuration and wiring
FIRST ETHERNET FAIL SECOND ETHERNET FAIL THIRD ETHERNET FAIL	Yes	A link loss detection on an Ethernet port. The link loss is due to unplugging the cable or the switch port being down.		Check the connection



Error	Latched?	Description	Test frequency	Action
Front Panel Trouble	No	The graphical front panel is not responsive for more than five seconds. The relay is still protecting, and the main CPU is not affected by this self-test.	Every second	Contact the factory
GFP Version Mismatch	No	The graphical front panel firmware revision is not synchronized with that of the CPU module in the relay	Whenever connection is established between the graphical front panel and the CPU module in the relay	Perform a UR firmware upgrade with the graphical front panel connected to the CPU module in the relay. It can be done using any communication interface (Ethernet or USB). This synchronizes the graphical firmware revision with that of the relay. If trouble persists, contact the factory.
GGIO Ind xxx oscill	No	A data item in a configurable GOOSE data set is oscillating	Upon scanning of each configurable GOOSE data set	The "xxx" text denotes the data item that has been detected as oscillating. Evaluate all logic pertaining to this item.
Oscillatory GOOSE	No	A data item in a configurable GOOSE data set is oscillating	Upon scanning of each configurable GOOSE data set	Evaluate all logic pertaining to this item
Replace Battery	Yes	The battery is weak or not functioning. It powers the real time clock. This message displays as Battery Fail in the event records. When the battery weakness reaches a critical level, the message displays persistently on the front panel and no front panel key navigation is possible.	Every five seconds. The error message displays after 60 seconds if the problem persists.	Replace the battery as outlined in the Maintenance chapter. To minimize the disruption until battery replacement, temporarily disable the battery fail function under <b>Settings &gt; Product Setup &gt; User-Programmable Self Tests</b> .
Setting Changed	No	Any device settings were changed over any available interface	On any setting changes, when new settings were written to device	Verify that the setting change was legitimate and essential for proper functioning of the protection and control system
SFP MODULE x FAIL	No	A faulty small form-factor pluggable port (SFP) or unplugging of the SFP generates this self test message		The web page "SFP Transceiver Information" described in the previous row applies for this self test as well. The "SFP Module Fail" has higher priority and it suppresses the "Ethernet Fail" target message. The "SFP MODULE FAIL FUNCTION" setting enables/disables this self test. The target for this self test is priority-based, with the third one being the highest priority. For example, if all three SFP modules fail, then the third SFP target is activated. If the third SFP module failure resolves, then the second SFP target is activated.
SNTP Failure	No	The SNTP server is not responding	Every 10 to 60 seconds	Check that Ethernet cable(s) are properly connected. Check that configuration for the SNTP server corresponds to the actual server settings. Check connectivity to the server (ping the server IP address). Check that UR settings for both SNTP servers are configured with different IP addresses and port numbers.
PROTOTYPE FIRMWARE: Self Test Error		Seen until the build is tagged as being 'release candidate' or 'gold' build	Seen on startup and then continuous	Update firmware to either of these builds

Error	Latched?	Description	Test frequency	Action
RRTD COMM FAIL: Self Test Error	No	Communications with remote RTD unit (RRTD) or GPM-F failed for longer than 10 seconds	Runs only if "Com2 Usage" is set to RRTD or RRTD&GPM-F. Checked every five seconds.	Check COM2 port settings, check RS485 cables
RxGOOSE FAIL: Missing messages	No	One or more RxGOOSE messages are not being received	The self-test is activated when no message is received within the expected time interval, which is the time-to-live time in the previous message. This time can be from milliseconds to minutes.	Check GOOSE setup
RxGOOSE OFFLINE: COMM Path Incomplete	No	One or more RxGOOSE messages are not responding	Event driven. The test is performed when a device programmed to receive GOOSE messages stops receiving. This can be from 1 to 60 seconds, depending on GOOSE packets.	Check GOOSE setup
SETTINGS SAVE ERROR: Contact Factory	Yes	The relay failed to store the settings to the flash memory	When a setting is changed	Contact the factory
STORAGE MEDIA ALARM: Self Test Error	No	The CPU module fails to read from or write to the Compact Flash (CF) card inside the module. The CF card stores certain non-volatile data, such as event records, oscillography and datalogger records, fault report values, and non-volatile actual values. Settings are not stored in CF and hence are unaffected by this self-test.	On power up. Afterwards, every time the CPU accesses the CF card for reading or writing	Contact the factory
SYSTEM EXCEPTION: Press RESET key	Yes	Abnormal restart from modules being removed or inserted while the G30 is powered-up, when there is an abnormal DC supply, or as a result of internal relay failure.	Event driven	Contact the factory
TEMP MONITOR: OVER TEMPERATURE	Yes	The ambient temperature is greater than the maximum operating temperature (+80°C)	Every hour	Remove the G30 from service and install in a location that meets operating temperature standards
UNIT NOT CALIBRATED: <i>with 2nd line DSP slot number detail</i>	Yes	DSP module is not calibrated or calibration data is out of range	On relay startup	The respective DSP module has to be replaced, contact factory service

Error	Latched?	Description	Test frequency	Action
VOLTAGE MONITOR: <i>with 2nd line detail</i>  Power Supply 12V Low Power Supply 12V High Power Supply 5V Low Power Supply 5V High	Yes	The relay detected a problem with the internal voltage rails for longer than 25 seconds	Every five seconds	Contact GE customer service
WRONG TRANSCEIVER: Self Test Error	Yes	The type of SFP does not match the CPU type. The SFP is a silver device that plugs into the rear of the CPU module.  T-type CPU = All ports support fiber SFPs only U-type CPU = Maintenance port needs RJ45 SFP and the other two ports fiber SFPs V-type CPU = All ports support RJ45 SFPs only  The consequence of an incorrect SFP can range from damage to the G30 to no power information for the G30 on its web page (enter IP address in a web browser, then click the <b>SFP Transceiver Information</b> — only the type of SFP displays and not power data).		A web page "SFP Transceiver Information" is provided. This page displays the type of the SFP in it. This data is to be used with the CPU type to know the cause of the problem.

#### 7.2.2.4 HardFiber major self-test error messages

In addition to those provided by the standard UR-series devices, the UR devices implement HardFiber self-tests. These are listed here. Any abnormal diagnostic condition indicated by the LEDs or the critical failure relay also results in a self-test message, so troubleshooting is described here. For other relays, such as the B95<sup>Plus</sup>, see that product's instruction manual.

Table 7-4: HardFiber major self-test errors

Error	Description	Severity	Action
EQUIPMENT MISMATCH	The number or type of installed hardware modules does not match the order code stored in the CPU. The standard UR-series Equipment Mismatch self-test is extended to cover the possible presence of a Process Card.	Protection is not available and all contact outputs and shared outputs are de-asserted	Check all modules against the order code. Ensure they are inserted properly, and cycle the control power. If a module has intentionally been added or removed use the Update Order Code command to notify the relay that the current module configuration is correct.
MODULE FAILURE	UR-series device module hardware failure detected	Protection is not available and all contact outputs and shared outputs are de-asserted	Contact the factory and supply the failure code noted in the display. Text in the message identifies the failed module (for example, H81). If operated on a Process Card failure, the Module Fail self-test seals-in (latches) till the UR-series device is restarted.
PROCESS BUS FAILURE	Mission critical data is not available via the process bus. An AC quantity is considered critical if both AC bank origins and the crosschecking settings are other than None. This self-test is also initiated by an AC input discrepancy being detected. See the description in the <b>Crosschecking</b> setting in the HardFiber manual for further information. In addition, this self-test can be initiated by user logic responding to loss of critical contact input/output or other data using the <b>Process Bus Failure Operand</b> user-programmable self-test setting. This setting is located in the <b>Settings &gt; Product Setup &gt; User-Programmable Self Test</b> menu.	Protection is not available and all contact outputs and shared outputs are de-asserted	<p>First rectify any Process Bus Trouble and Brick Trouble self-test errors. Check the actual value of the operand referenced by the Process Bus Failure Operand setting, and if “On,” determine the cause and rectify.</p> <p>If the problem persists with the foregoing all clear, the cause must be an AC input discrepancy, which is typically the result of problems in the input signals to the Bricks, or faults in the Brick input conditioning hardware. If the error was annunciated the first time significant signal was encountered, suspect the former cause and check the copper connections external to the Brick. Where multiple UR-series devices have self-test errors, look for common causes.</p> <p>To further isolate AC input discrepancy errors, put the relay in test-isolated mode, then one by one, temporarily change an AC bank Crosschecking setting to None, until the Process Bus Failure clears. Once the problem AC bank has been identified, the values from each of the two Bricks can be examined individually by temporarily mapping each to an AC bank with a single origin.</p>

## 7.2.2.5 HardFiber minor self-test error messages

Table 7-5: HardFiber minor self-test errors

Error	Description	Severity	Action
BRICK TROUBLE	Brick internal self-testing has detected trouble internal to the Brick	This self-test error does not directly inhibit protection. However, some or all of the affected Brick inputs/outputs may not be available to the UR device.	Check the Brick environment for over/under temperatures and the voltage of its power source. If the ambient temperature and supply voltage are within Brick specifications, consult the factory. Troubles resulting from a Brick output failing to respond to an output command can only be detected while the command is active, and so in this case the target is latched. A latched target can be unlatched by pressing the front panel reset key if the command has ended, however the output can still be non-functional.
PROCESS BUS TROUBLE	Communications problems with one or more Bricks. The text of the message identifies the affected field units. This self-test is initiated by low received signal levels at either the Brick or Process Card end, and by the sustained failure to receive poll responses from the proper Brick.	This self-test error does not directly inhibit protection. However, the affected Brick inputs/outputs may not be available to the UR device.	<p>Check the field unit actual values. An indication of equipment mismatch means that messages are being received from a Brick, but there is a discrepancy between the settings and the actual Brick serial number, order code, and/or core number.</p> <p>Check that the correct core on the correct Brick is patched through to the correct Process Card port, and that the field unit settings are correct. An indication of communications loss means that no messages are being received.</p> <p>Check that the patching is correct, and that the Brick has power. If that is not the problem, use a professional optical fiber connector cleaning kit to clean both sides of all optical fiber connections from the Process Card through to the affected Brick. If the problem continues after cleaning, consult the factory.</p>
RTD TROUBLE: Self Test Error	The Brick is reporting that the sensed RTD field connection does not match that of an RTD or the reported DC input value is outside of the RTD temperature range, greater than 250°C (likely open sensor circuit fault) or less than -50°C (likely shorted sensor fault).	Not latched	Check field RTD settings and connections
TDR TROUBLE: Self Test Error	The Brick is reporting that the sensed transducer field connection does not match that of a transducer, or the reported DC input value is outside of the set transducer input range, or the minimum value setting is equal to the maximum value setting.	Not latched	Check field transducer settings and connections



# G30 Generator Protection System

## Chapter 8: Application of settings

This chapter provides example(s) of use.

---

### 8.1 Overview

#### 8.1.1 Introduction

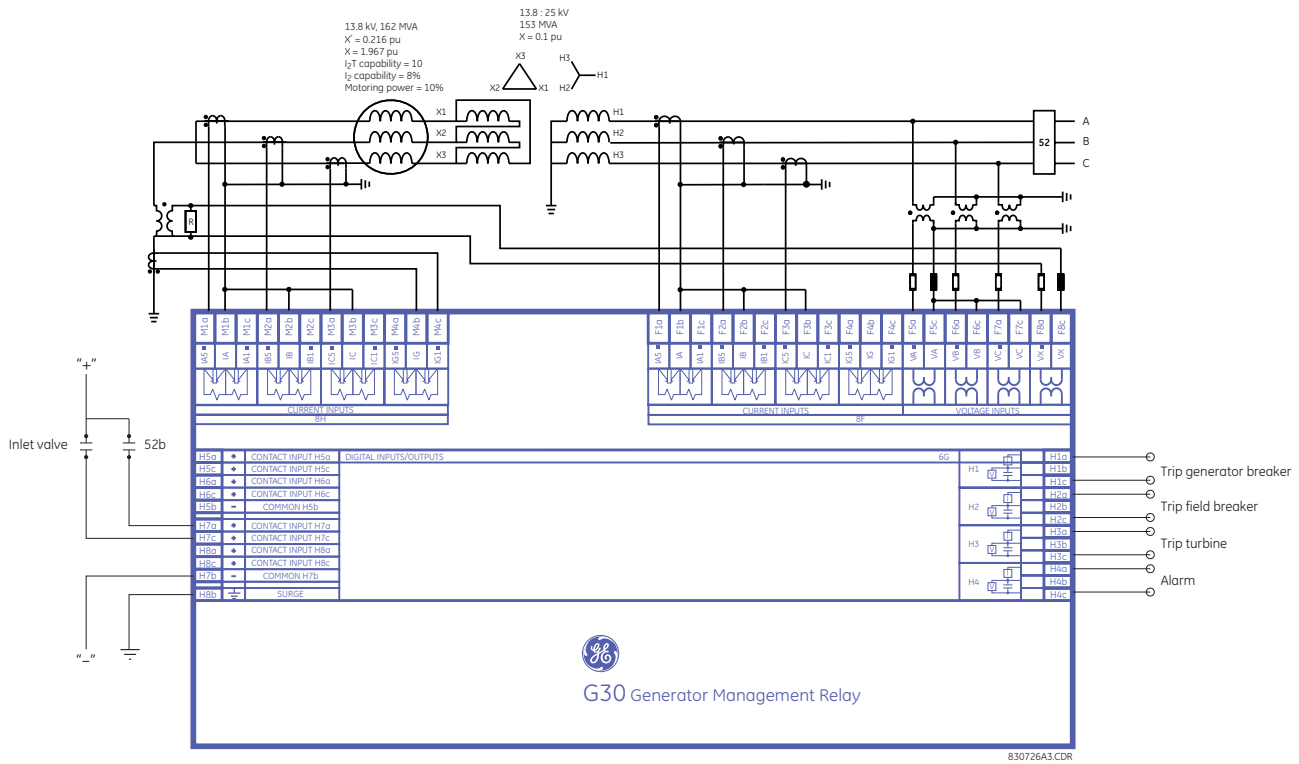
This section outlines three examples of system configuration:

- In-zone transformer with VT on the high-voltage (HV) side
- In-zone transformer with VT on the low-voltage (LV) side
- With no in-zone transformer

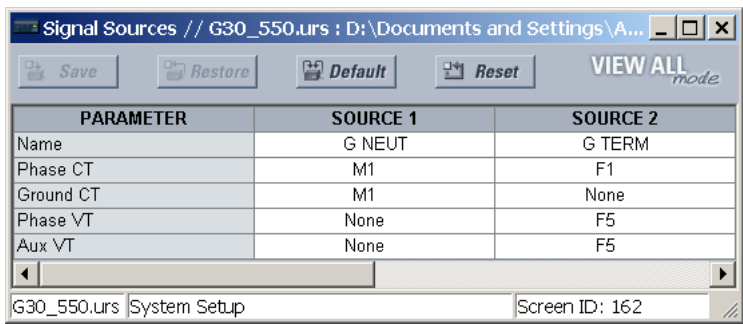
#### 8.1.2 In-zone transformer with VT on the high-voltage side

Consider the generator protection system show, with an in-zone transformer with VT on the high-voltage (HV) side.

Figure 8-1: Typical wiring, VT on the high-voltage side of the transformer



The two sources are configured as follows.



8

The generator step-up (GSU) transformer is lagging by  $-30^\circ$  (from the line side to the generator side). Take note of the CT polarities in wiring diagram. These are necessary to correctly meter forward power. Loss of excitation and reverse power are to be assigned to source 2.

The transformer phase shift setting must compensate the measured relay currents for both the actual phase shift of the transformer, and any phase due to the CT polarities and connections.

The difference seen by the differential is the transformer phase shift plus the CT phase shift, or  $-30^\circ + (-180^\circ) = -210^\circ$ . The transformer configuration is therefore as shown in the following figure.



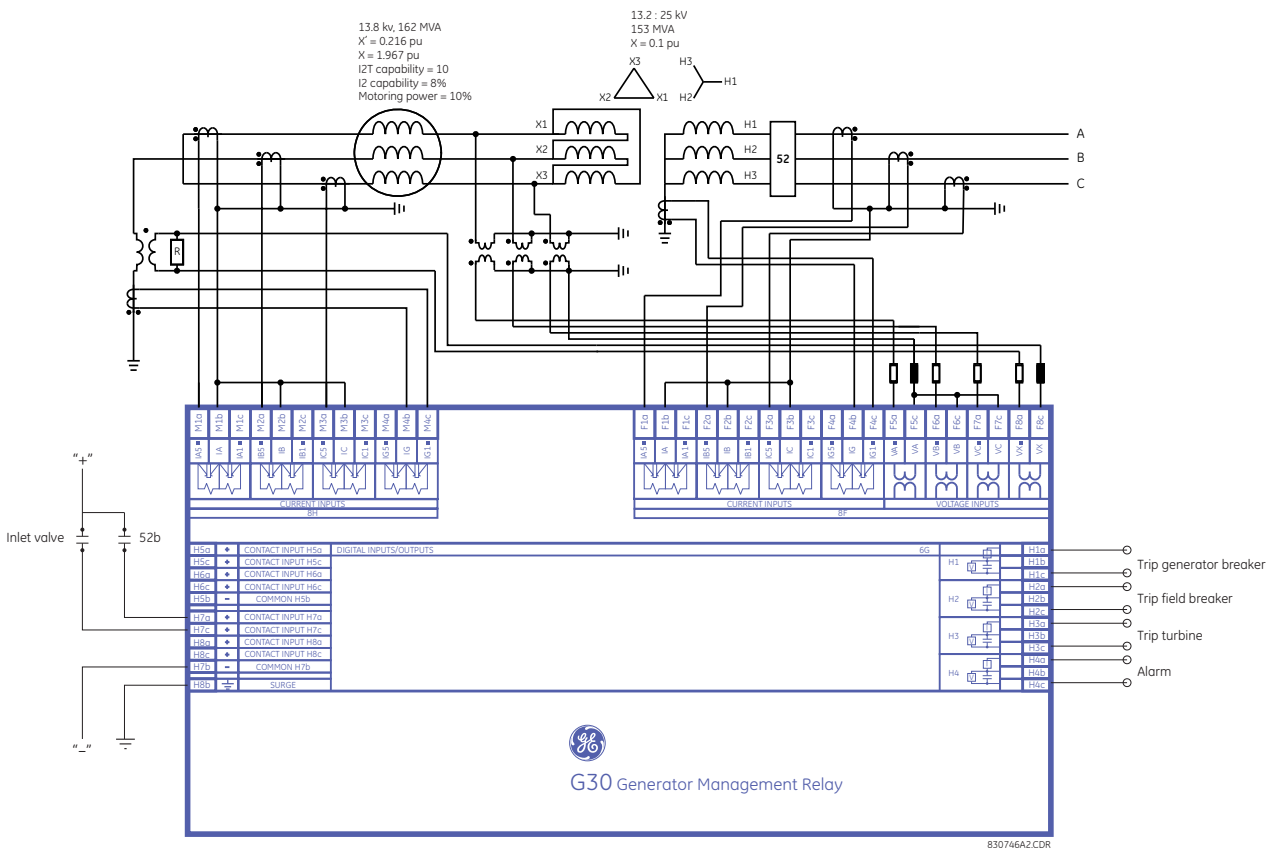
PARAMETER	WINDING 1	WINDING 2
Source	G NEUT (SRC 1)	G TERM (SRC 2)
Rated MVA	160.000 MVA	160.000 MVA
Nominal Phs-phs Voltage	13.800 kV	25.000 kV
Connection	Delta	Wye
Grounding	Within zone	Not within zone
Angle Wrt Winding 1	0.0 deg	-210.0 deg

G30\_550.urs | System Setup: Transformer | Screen ID: 166

### 8.1.3 In-zone transformer with VT on the low-voltage side

Consider the generator protection system shown, with an in-zone transformer with VT on the low-voltage (LV) side.

Figure 8-2: Typical wiring, VT on the low-voltage side of the transformer



The two sources are configured as follows.

PARAMETER	SOURCE 1	SOURCE 2
Name	GEN	LINE
Phase CT	M1	F1
Ground CT	M1	F1
Phase VT	F5	None
Aux VT	F5	None

G30\_550.urs System Setup Screen ID: 162

The GSU is again lagging by  $-30^\circ$  (from the line side to the generator side). Loss of excitation and reverse power is to be assigned to source 1. In this case, the only phase shift that must be accounted for is the phase shift of the transformer. Winding 2 is therefore shifted by  $-30^\circ$ .

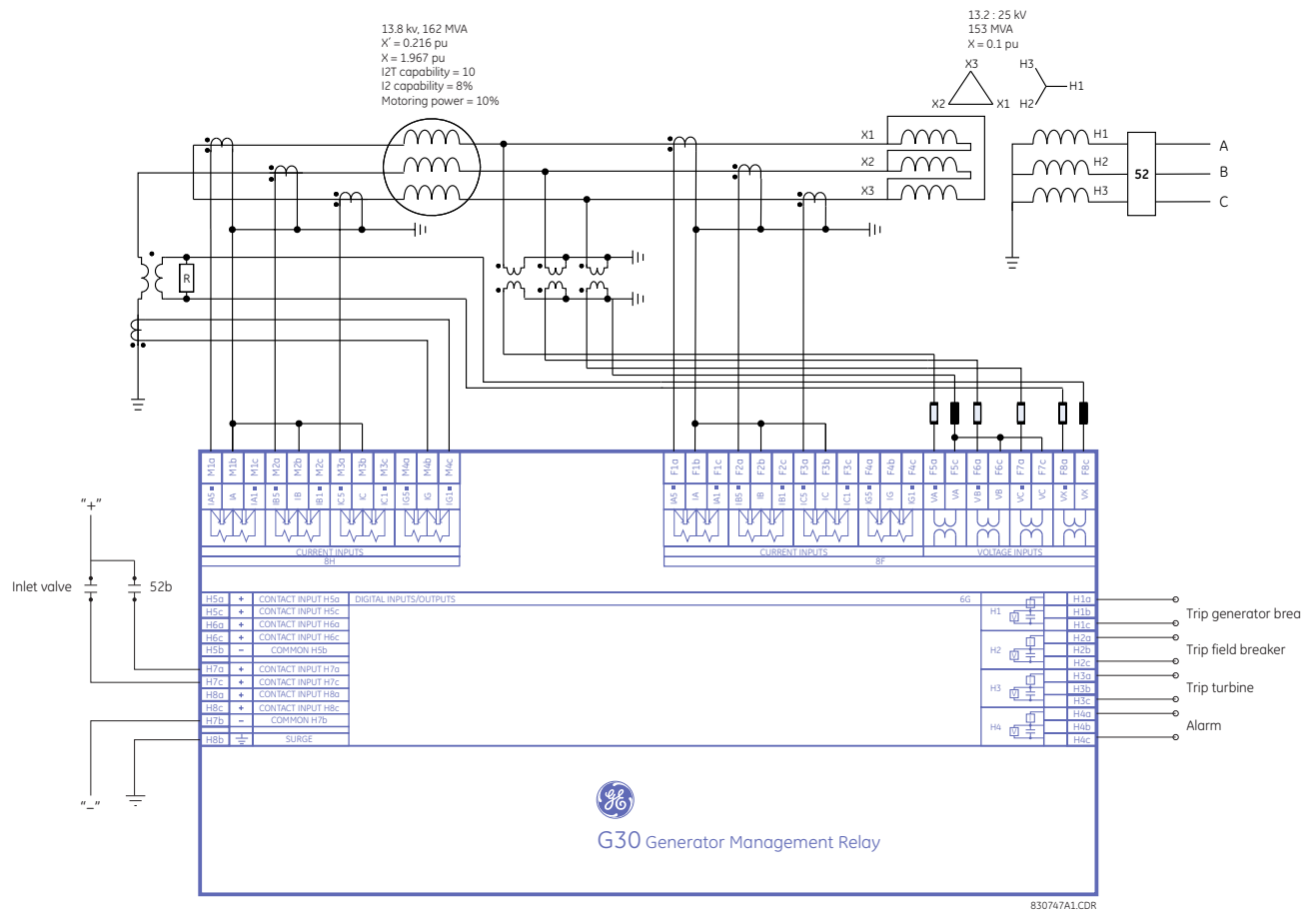
PARAMETER	WINDING 1	WINDING 2
Source	LINE (SRC 2)	GEN (SRC 1)
Rated MVA	160.000 MVA	160.000 MVA
Nominal Phs-phs Voltage	25.000 kV	13.800 kV
Connection	Wye	Delta
Grounding	Within zone	Not within zone
Angle Wrt Winding 1	0.0 deg	-30.0 deg

G30\_550.urs System Setup: Transformer Screen ID: 166

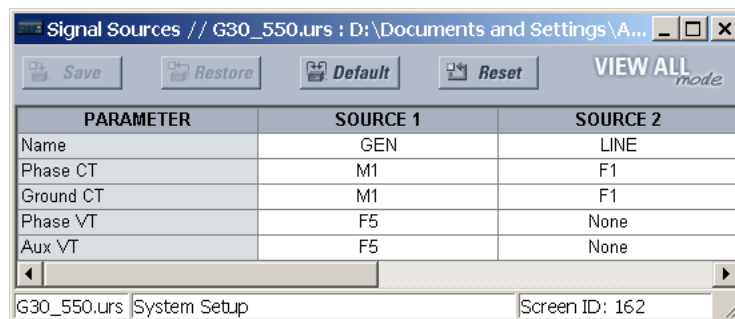
### 8.1.4 No in-zone transformer

Consider the generator protection system shown, with no in-zone transformer.

Figure 8-3: Typical wiring, no in-zone transformer



The two sources are configured as follows.



The G30 requires the use of the transformer windings settings for the differential element, even if the differential is applied only as a stator differential for the generator. These settings ensure that the differential element operates with the correct phase shifts, and applies the correct magnitude compensation. Loss of excitation and reverse power can be assigned to either source. Since there is no transformer involved, the phase shift to enter is the  $-180^\circ$  phase shift due to the CT polarities and connections.

PARAMETER	WINDING 1	WINDING 2
Source	LINE (SRC 2)	GEN (SRC 1)
Rated MVA	160.000 MVA	160.000 MVA
Nominal Phs-phs Voltage	13.800 kV	13.800 kV
Connection	Wye	Wye
Grounding	Not within zone	Not within zone
Angle Wrt Winding 1	0.0 deg	-180.0 deg

G60\_550.urs System Setup: Transformer Screen ID: 166

## 8.2 Settings

### 8.2.1 System setup

Ideally, the CTs are selected so that the generator nominal current is 80 to 85% of CT primary. The following settings are entered for the example system. The M5 bank and the ground CT input on each of the groups are unused in this example. The nominal current is given by:

$$I_{nom}(13.8\text{ kV}) = \frac{S_{nom}}{\sqrt{3}V_{nom}} = \frac{162 \times 10^6\text{ VA}}{\sqrt{3} \times 13.8 \times 10^3\text{ V}} = 6800\text{ A} \tag{Eq. 8-1}$$

Make the following settings changes in the EnerVista UR Setup software or the front panel **SYSTEM SETUP** ⇒ **AC INPUTS** ⇒ **CURRENT BANK F1** and the **SYSTEM SETUP** ⇒ **AC INPUTS** ⇒ **CURRENT BANK M1** menus.

PARAMETER	CT F1	CT M1	CT M5
Phase CT Primary	8000 A	8000 A	1 A
Phase CT Secondary	5 A	5 A	1 A
Ground CT Primary	1 A	1 A	1 A
Ground CT Secondary	1 A	1 A	1 A

G60\_500.urs System Setup: AC Inputs

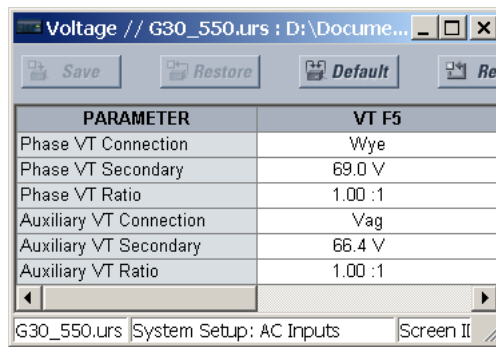
For the example system, the voltage settings are calculated as follows:

$$\text{PHASE VT SECONDARY} = \frac{18000\text{ V}}{\sqrt{3}} \times \frac{120\text{ V}}{13800\text{ V}} = 69\text{ V} \tag{Eq. 8-2}$$

$$\text{PHASE VT RATIO} = \frac{13800\text{ V}}{120\text{ V}} = 115 \tag{Eq. 8-3}$$

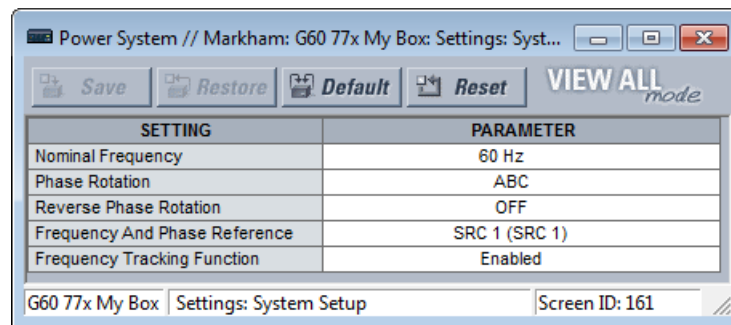
$$\text{NEUTRAL VT RATIO} = \frac{13800\text{ V}}{\sqrt{3} \times 240\text{ V}} = 33 \tag{Eq. 8-4}$$

Enter the following values through the EnerVista software or the front panel **SETTINGS** ⇒ **SYSTEM SETUP** ⇒ **AC INPUTS** ⇒ **VOLTAGE BANK F5** menu.



### 8.2.2 Power system

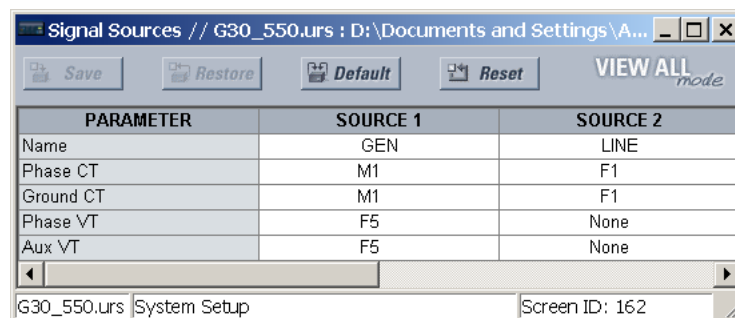
Always enable frequency tracking for generator applications. Make the following power system parameters changes in the EnerVista software or the front panel **SETTINGS** ⇒ **SYSTEM SETUP** ⇒ **POWER SYSTEM** ⇒ **VOLTAGE BANK F5** menu.



### 8.2.3 Signal sources

Two sources are required for this application example. The “LINE” source uses the phase and auxiliary VT inputs and the CT input wired to the generator output CT. The “GEN” source uses the phase VT inputs and the CT input wired to the generator neutral CT. Including the phase VT inputs for both sources allows the user to choose the location of elements that use both voltage and current. Elements using the auxiliary VT input are assigned to the “GEN” source.

Make the following changes through the EnerVista software or the front panel **SETTINGS** ⇒ **SYSTEM SETUP** ⇒ **SOURCE 1** and **SETTINGS** ⇒ **SYSTEM SETUP** ⇒ **SOURCE 2** menus.



### 8.2.4 Generator unbalance

Stage 1 of the generator unbalance element is typically used to trip the generator. In this example, the  $I_2$  capability of the machine is 8% and the  $I_2^2T$  capability is 10. The generator nominal current is:

$$I_{nom}(pu) = \frac{I_{nom \text{ primary}}}{CT_{primary}} = \frac{6800 \text{ A}}{8000 \text{ A}} = 0.85 \text{ pu} \tag{Eq. 8-5}$$

The minimum operate time of stage 1 is to be set to 0.25 seconds, the maximum operating time is to be 10 minutes, and the reset time is to be set to 4 minutes.

Stage 2 is typically set lower than stage 1 with a time delay to prevent nuisance alarms for external faults that are normally cleared by system protection. For the application example, the pickup setting is:

$$\text{Pickup} = 70\% \times I_2 \text{ capability} = 0.70 \times 8\% = 5.6\% \tag{Eq. 8-6}$$

Source 2 is to be chosen for this element. The settings are as follows.

SETTING	PARAMETER
Function	Enabled
Source	NEUTRL (SRC 2)
Inom	0.850 pu
Stage 1 Pickup	8.00 %
Stage 1 K-Value	10.00
Stage 1 Tmin	0.250 s
Stage 1 Tmax	600.0 s
Stage 1 K-Reset	240.0 s
Stage 2 Pickup	5.60 %
Stage 2 Pickup Delay	10.0 s
Block	OFF
Target	Latched
Events	Enabled

## 8.2.5 Loss of excitation

For the example system, we have the following values:

$$Z_{b(\text{sec})} = \frac{\text{base kV}^2}{\text{base MVA}} \times \frac{\text{CT ratio}}{\text{VT ratio}} = \frac{(18 \text{ kV})^2}{211.765 \text{ MVA}} \times \frac{1600}{157.5} = 15.54 \ \Omega \quad \text{Eq. 8-7}$$

$$X_d'(\text{sec}) = X_d' \times Z_b(\text{sec}) = 0.216 \times 15.54 \ \Omega = 3.36 \ \Omega \quad \text{Eq. 8-8}$$

$$X_d(\text{sec}) = X_d \times Z_b(\text{sec}) = 1.967 \times 15.54 \ \Omega = 30.57 \ \Omega \quad \text{Eq. 8-9}$$

$$\text{CENTER 1} = \frac{Z_b(\text{sec}) + X_d'(\text{sec})}{2} = \frac{15.54 \ \Omega + 3.36 \ \Omega}{2} = 9.45 \ \Omega \quad \text{Eq. 8-10}$$

$$\text{RADIUS 1} = \frac{Z_b(\text{sec})}{2} = \frac{15.54 \ \Omega}{2} = 7.77 \ \Omega \quad \text{Eq. 8-11}$$

$$\text{PICKUP DELAY 1} = 0.06 \text{ seconds} \quad \text{Eq. 8-12}$$

$$\text{CENTER 2} = \frac{X_d(\text{sec}) + X_d'(\text{sec})}{2} = \frac{30.57 \ \Omega + 3.36 \ \Omega}{2} = 16.97 \ \Omega \quad \text{Eq. 8-13}$$

$$\text{RADIUS 2} = \frac{X_d(\text{sec})}{2} = \frac{30.57 \ \Omega}{2} = 15.28 \ \Omega \quad \text{Eq. 8-14}$$

The voltage supervision setting is determined by a system study and can be disabled on either element if required. VT fuse failure supervises this element.

The source used for loss of excitation produces positive power when the machine is generating. Make the following changes in the EnerVista software or the front panel **SETTINGS** ⇒ **GROUPED ELEMENTS** ⇒ **SETTING GROUP 1** ⇒ **LOSS OF EXCITATION** menu.

SETTING	PARAMETER
Function	Enabled
Source	OUTPUT (SRC 1)
Center 1	9.45 ohm
Radius 1	7.77 ohm
UV Supervision Enable 1	Disabled
Pickup Delay 1	0.060 s
Center 2	16.97 ohm
Radius 2	15.28 ohm
UV Supervision Enable 2	Disabled
Pickup Delay 2	0.500 s
UV Supervision	0.700 pu
Block	SRC1 VT FUSE FAIL OP
Target	Latched
Events	Enabled

### 8.2.6 Reverse power

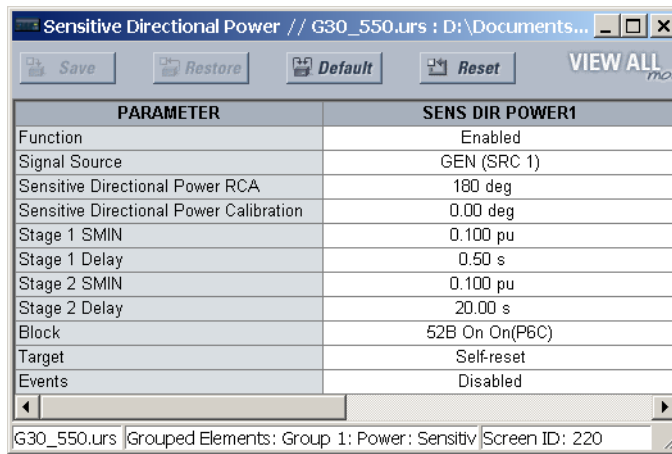
The reverse power element is set at ½ the rated motoring power. The pickup is calculated as follows:

$$S_{min} = \frac{1}{2} \times \frac{\text{Rated Motoring Power (primary watts)}}{3 \times \text{Phase CT Primary} \times \text{Phase VT Ratio} \times \text{Phase VT Secondary}} \tag{Eq. 8-15}$$

For the example system:

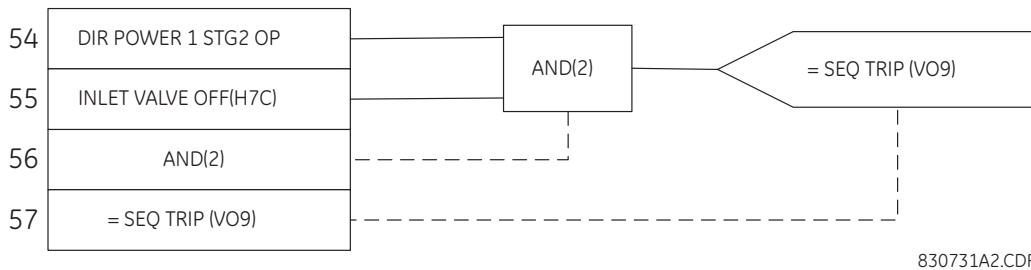
$$S_{min} = \frac{1}{2} \times \frac{22 \times 10^6 \text{ W}}{3 \times 8000 \text{ A} \times 115 \times 69 \text{ V}} = 0.033 \text{ pu} \tag{Eq. 8-16}$$

To prevent maloperation for power swings the element is typically time delayed by 20 to 30 seconds. For sequential tripping applications the time delay is to be 2 to 3 seconds. The element can be blocked when the generator is offline. The line source is to be used for this application. Make the following changes in the EnerVista software or the front panel **SETTINGS ⇒ GROUPED ELEMENTS ⇒ SETTING GROUP 1 ⇒ SENSITIVE DIRECTIONAL POWER ⇒ DIRECTIONAL POWER 1** menu.



Sequential tripping logic can be implemented in FlexLogic as follows.

Figure 8-4: Sequential tripping FlexLogic



830731A2.CDR

### 8.2.7 System backup overcurrent

System backup protection is implemented using a phase time overcurrent element with voltage restraint enabled. The NEUTRL source is to be chosen for this element. Set the pickup of this element at a safe margin above the maximum load expected on the machine.

$$\text{PICKUP} = 1.5 \times \frac{\text{Generator Nominal Current}}{\text{CT Primary}} = 1.5 \times \frac{6800}{8000} = 1.275 \text{ pu} \tag{Eq. 8-17}$$



The selection of all standard curves (and FlexCurves) is allowed for easy coordination with system relaying. For the example system, an IEEE extremely inverse curve is used and a setting is chosen such that the operate time for a three-phase fault on the high side of the transformer is 0.75 seconds. For simplicity, the power system contribution is not considered.

$$\text{Transformer Impedance} = 0.10 \times \frac{162}{153} = 0.106 \text{ pu on machine base} \quad \text{Eq. 8-18}$$

$$\text{Impedance to Fault} = 0.216 + 0.106 = 0.322 \text{ pu} \quad \text{Eq. 8-19}$$

$$\text{Fault Current} = \frac{V}{X} = \frac{1}{0.322} \times \frac{6800}{8000} = 2.64 \text{ pu} \quad \text{Eq. 8-20}$$

$$\text{Fault Voltage} = \text{Nominal Voltage} \times \frac{\text{Transformer Impedance}}{\text{Total Impedance}} = 13.8 \text{ kV} \times \frac{10.6}{32.2} = 4543 \text{ V} \quad \text{Eq. 8-21}$$

$$\text{Pickup Reduction} = \frac{\text{Fault Voltage}}{\text{Generator Nominal Voltage}} = \frac{4543 \text{ V}}{13.8 \text{ kV}} = 0.329 \quad \text{Eq. 8-22}$$

The equation for an IEEE extremely inverse curve is as follows:

$$T = \text{TDM} \times \left[ \frac{A}{\left( \frac{I}{I_{\text{pickup}} \times \text{Pickup Reduction}} \right)^p - 1} + B \right] \quad \text{Eq. 8-23}$$

where  $A = 28.2$ ,  $B = 0.1217$ , and  $p = 2$ . Solving for TDM, we have:

$$\text{TDM} = \frac{0.75}{\frac{28.2}{\left( \frac{2.64}{1.275 \times 0.329} \right)^2 - 1} + 0.1217} = 0.88 \quad \text{Eq. 8-24}$$

Since this element coordinates with system protections, a timed reset is chosen. The element must be blocked for a VT fuse failure. The neutral source is chosen. Make the following changes in the EnerVista software or the front panel **SETTINGS** ⇒ **GROUPED ELEMENTS** ⇒ **SETTING GROUP 1** ⇒ **PHASE CURRENT** ⇒ **PHASE TOC1** menu.

Phase TOC // Markham: G60 77x My Box: Settings: Grou...

Save Restore Default Reset VIEW ALL mode

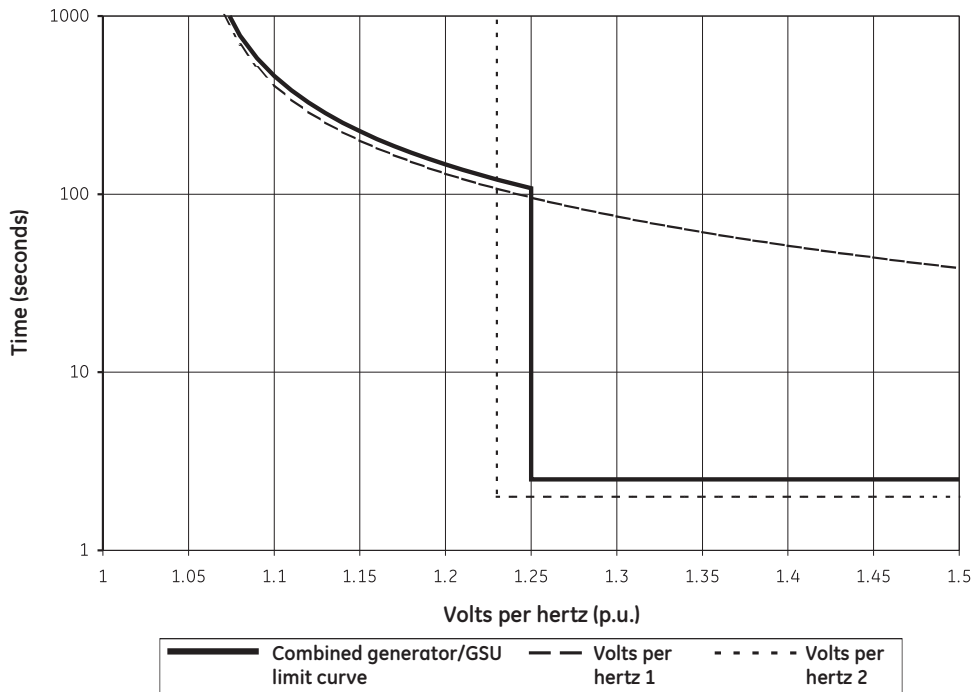
PARAMETER	PHASE TOC2
Function	Disabled
Signal Source	NEUTRL (SRC 2)
Input	Phasor
Pickup	1.275 pu
Curve	IEEE Ext Inv
TD Multiplier	0.88
Reset	Timed
Voltage Restraint	Enabled
Block A	SRC2 VT FUSE FAIL OP
Block B	SRC2 VT FUSE FAIL OP
Block C	SRC2 VT FUSE FAIL OP
Target	Latched
Events	Enabled

G60 77x My Box | Settings: Grouped Elements: Group 1: Ph | Screen ID: 215

### 8.2.8 Overexcitation

This protection is to be set to coordinate with the manufacturer’s excitation capability curves. For the example system, the combined generator/GSU limit curve is shown as follows.

Figure 8-5: Generator/GSU limit curve



830734A1.CDR

Program the volts per hertz 1 element with an inverse characteristic (curve A), a pickup of 1.05, and a TDM of 40. Program the volts per hertz 2 element with a definite time characteristic, a pickup of 1.23, and a time delay of 2 seconds. Both elements are thus set to issue a trip. The volts per hertz 1 pickup is to be used to generate an alarm. Either source can be assigned in this example. Make the following changes in the EnerVista software or the front panel **SETTINGS** ⇒ **GROUPED ELEMENTS** ⇒ **SETTING GROUP 1** ⇒ **VOLTAGE ELEMENTS** ⇒ **VOLTS/HZ 1(2)** menus.

PARAMETER	VOLTS PER HERTZ 1	VOLTS PER HERTZ 2
Function	Enabled	Enabled
Source	OUTPUT (SRC 1)	OUTPUT (SRC 1)
Pickup	1.05 pu	1.23 pu
Curves	Inverse A	Definite Time
TD Multiplier	10.00	2.00
T Reset	30.0 s	0.0 s
Block	OFF	OFF
Target	Latched	Latched
Events	Enabled	Enabled

G60\_500.urs | Grouped Elements: Group 1: Voltage Elements

## 8.2.9 Inputs/outputs

The following inputs and outputs are used in this example. Make the following changes in the EnerVista software or the front panel **SETTINGS** ⇒ **INPUTS/OUTPUTS** ⇒ **CONTACT INPUTS** ⇒ **CONTACT INPUT H7a(H7c)** menus.

PARAMETER	H7A	H8
Contact Input 1 Name	Offline	INLET VALUE
Debounce Time	2.0 ms	2.0 ms
Events	Disabled	Disabled

G60\_500.urs | Inputs/Outputs

Make the following changes in the EnerVista software or the **SETTINGS** ⇒ **INPUTS/OUTPUTS** ⇒ **VIRTUAL OUTPUTS** ⇒ **VIRTUAL OUTPUT 1(4)** menus.

PARAMETER	VIRTUAL OUTPUT 1	VIRTUAL OUTPUT 2	VIRTUAL OUTPUT 3	VIRTUAL OUTPUT 4
Virtual Output 1 Name	GEN BKR TRIP	FLD BKR TRIP	TURBINE TRIP	ALARM
Events	Enabled	Enabled	Enabled	Enabled

G60\_500.urs | Inputs/Outputs

Make the following changes in the EnerVista software or the **SETTINGS** ⇒ **INPUTS/OUTPUTS** ⇒ **CONTACT OUTPUTS** ⇒ **CONTACT OUTPUT H1(H4)** menus.

CONTACT OUTPUTS // G60\_500.urs : C:\Documents and Settings\All Users\Documents\...

Save Restore Default Reset VIEW ALL mode

PARAMETER	H1	H2
Contact Output 1 Name	94GB	94FB
Operate	GEN BKR TRIP On (VO1)	FLD BKR TRIP On (VO2)
Seal-In	94GB IO n (H1)	94FB IO n (H2)
Reset	n/a	n/a
Type	n/a	n/a
Events	Enabled	Enabled

G60\_500.urs |Inputs/Outputs

CONTACT OUTPUTS // G60\_500.urs : C:\Documents and Settings\All Users\Documents\...

Save Restore Default Reset VIEW ALL mode

PARAMETER	H3	H4
Contact Output 1 Name	94T	74
Operate	TURBINE TRIP On (VO3)	ALARM On (VO4)
Seal-In	OFF	OFF
Reset	n/a	n/a
Type	n/a	n/a
Events	Enabled	Enabled

G60\_500.urs |Inputs/Outputs

### 8.2.10 Frequency

The pickup and delay settings depend on operating practices and system characteristics. In this example, two overfrequency and two underfrequency elements are to be used. The elements are to be blocked when offline. Underfrequency is to initiate a trip. Overfrequency is to alarm only. Either source can be assigned.

Make the following changes in the EnerVista software or the front panel **SETTINGS** ⇒ **CONTROL ELEMENTS** ⇒ **UNDERFREQUENCY** ⇒ **UNDERFREQUENCY 1(2)** and **SETTINGS** ⇒ **CONTROL ELEMENTS** ⇒ **OVERFREQUENCY** ⇒ **OVERFREQUENCY 1(2)** menus.

PARAMETER	UNDERFREQUENCY 1	UNDERFREQUENCY 2	UNDERFREQUENCY 3	UNDERFREQUENCY 4
Function	Enabled	Enabled	Enabled	Enabled
Block	Offline On(H7a)	Offline On(H7a)	Offline On(H7a)	Offline ON(H7a)
Source	OUTPUT (SRC 1)	OUTPUT (SRC 1)	OUTPUT (SRC 1)	OUTPUT (SRC 1)
Min Volt/Amp	0.10 pu	0.10 pu	0.10 pu	0.10 pu
Pickup	59.00 Hz	58.00 Hz	57.00 Hz	56.00 Hz
Pickup Delay	65.000 s	30.000 s	10.000 s	1.000 s
Reset Delay	0.000 s	0.000 s	0.000 s	0.000 s
Target	Latched	Latched	Latched	Latched
Events	Enabled	Enabled	Enabled	Enabled

PARAMETER	OVERFREQUENCY 1	OVERFREQUENCY 2
Function	Enabled	Enabled
Block	52B On(H7a)	52B On(H7a)
Source	OUTPUT (SRC 1)	OUTPUT (SRC 1)
Pickup	61.00 Hz	62.00 Hz
Pickup Delay	60.000 s	30.000 s
Reset Delay	0.000 s	0.000 s
Target	Latched	Latched
Events	Enabled	Enabled

### 8.2.11 Accidental energization

In this example, the **ACCDNT ENRG ARMING MODE** is selected as “UV and Offline.” The **ACCDNT ENRG OC PICKUP** setting is to be set at half the minimum expected fault current, and in this case 1.0 pu (8000 A primary) is selected. In cases where it is possible to re-energize the machine through its auxiliary transformer, a lower setting can be required. The undervoltage pickup setting must be set above the maximum expected fault voltage; 0.700 pu is used here.

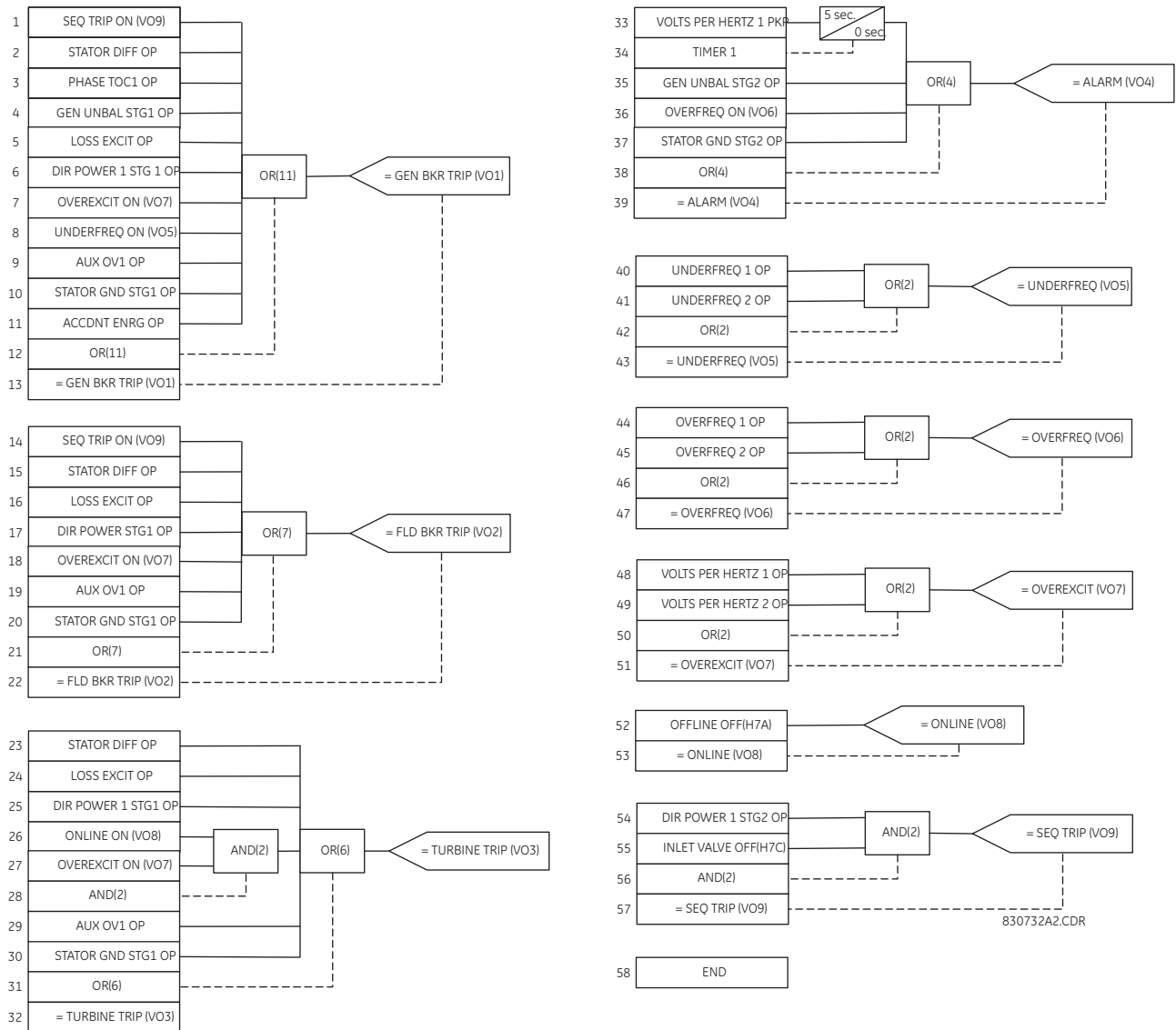
Make the following changes in the EnerVista software or the front panel **SETTING S** ⇒ **GROUPED ELEMENTS** ⇒ **SETTING GROUP 1** ⇒ **ACCIDENTAL ENERGIZATION** menu.

SETTING	PARAMETER
Function	Enabled
Source	OUTPUT (SRC 1)
Accidental Energization Arming Mode	UV AND OFFLINE
Accidental Energization OC Pickup	1.000
Accidental Energization UV Pickup	0.700
Accidental Energization Offline	Offline On(H7a)
Block	OFF
Target	Latched
Events	Enabled

### 8.2.12 FlexLogic

The following logic as given as an example. The logic for each specific application depends on system design, protection philosophies, and operating practices.

Figure 8-6: Application example FlexLogic



# G30 Generator Protection System

## Chapter 9: Commissioning

---

### 9.1 Testing

#### 9.1.1 Testing underfrequency and overfrequency elements

Underfrequency and overfrequency protection requires techniques with subtle testing implications. Whereas most protection is designed to detect changes from normal to fault conditions that occur virtually instantaneously, power system inertia requires frequency protection to pick up while the frequency is changing slowly. Frequency measurement is inherently sensitive to noise, making high precision in combination with high speed challenging for both relays and test equipment.

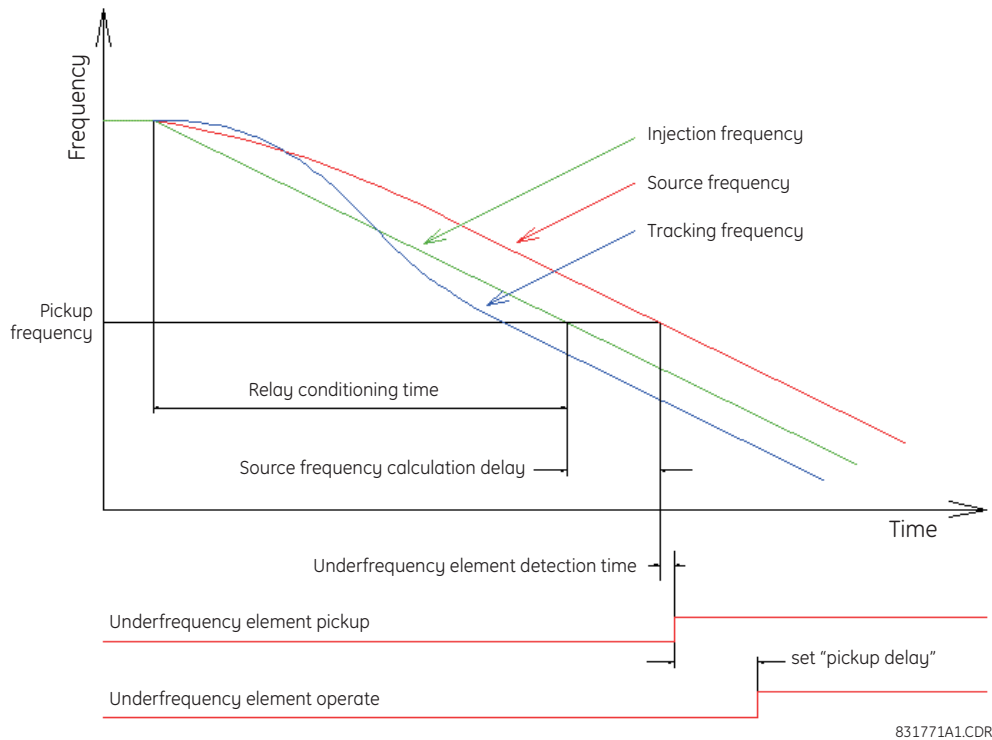
Injection to a particular G30 frequency element must be to its configured source and to the channels that the source uses for frequency measurement. For frequency measurement, a source uses the first quantity configured in the following order:

1. Phase voltages
2. Auxiliary voltage
3. Phase currents
4. Ground current

For example, if auxiliary voltage and phase currents are configured, the source uses the auxiliary voltage, not the phase voltages or any of the currents.

When phase voltages or phase currents are used, the source applies a filter that rejects the zero-sequence component. As such, the same signal must not be injected to all three phases, or the injected signal is completely filtered out. For an underfrequency element using phase quantities, the phase A signal must be above the **MIN VOLT/AMP** setting value. Therefore, either inject into phase A only, or inject a balanced three-phase signal.

Figure 9-1: Typical underfrequency element test timing



The static accuracy of the frequency threshold is determined by slowly adjusting the frequency of the injected signal about the set pickup. If the G30 frequency metering feature is used to determine the injected frequency, verify the metering accuracy by checking it against a known standard (for example, the power system).

To accurately measure the time delay of a frequency element, a test emulating realistic power system dynamics is required. Let the injected frequency ramp smoothly through the set threshold, with the ramp starting frequency sufficiently outside the threshold so that the relay becomes conditioned to the trend before operation. For typical interconnected power systems, the recommended testing ramp rate is 0.20 Hz/s.

The required delay time is the interval from the point the frequency crosses the set threshold to the point that the element operates. Some test sets can measure only the time from the ramp start to element operation, necessitating the subtraction of the pre-threshold ramp time from the reading. For example, with a ramp rate of 0.20 Hz/s, start the ramp 0.20 Hz before the threshold and subtract 1 second from the test set time reading of ramp start to relay operation.

Note that the G30 event records only show the "pickup delay" component, a definite time timer. This is exclusive of the time taken by the frequency responding component to pickup.

G30 oscillography can be used to measure the time between the calculated source frequency crossing the threshold and element operation; however, this method omits the delay in the calculated source frequency. The security features of the source frequency measurement algorithm result in the calculated frequency being delayed by two to four cycles (or longer with noise on the input). In addition, oscillography resolution is 0.004 Hz, which at 0.20 Hz/s corresponds to a delay of 20 ms. Do not use the tracking frequency in timing measurements, as its algorithm involves phase locking, which purposely sets its frequency high or low to allow the G30 sample clock to catch-up or wait as necessary to reach synchronism with the power system.



# G30 Generator Protection System

## Chapter 10: Theory of operation

This chapter outlines advanced information on operation.

---

### 10.1 Directional principle

#### 10.1.1 Current directional protection

For better security, the G30 uses the current directional protection principle to dynamically supervise the main current differential function. The directional principle is in effect permanently for low differential currents (region 1 in the Two Regions of Differential Characteristic figure) and is switched on dynamically for large differential currents (region 2 in the same figure) by the saturation detector (see the Saturation Detector section) upon detecting CT saturation.

The directional principle responds to a relative direction of the fault currents. This means that a reference signal, such as transformer voltage, is not required. The directional principle declares that

- If all of the fault currents flow in one direction, the fault is internal, or
- If at least one fault current flows in an opposite direction compared with the sum of the remaining currents, the fault is external

The directional principle is implemented in two stages.

First, based on the magnitude of a given current, it is determined whether the current is a fault current. If so, its relative phase relation has to be considered. The angle check must not be initiated for the load currents as the direction is out of the transformer even during internal faults. The auxiliary comparator of this stage applies an adaptable threshold. The threshold is a fraction of the restraining current. The current from a particular feeder is used for bus directional comparison if its magnitude is greater than  $0.2 \times I_{\text{restraint}}$  or it is greater than 2 times its CT rating.

Second, for the selected fault currents, the phase angle between a given current and the sum of all the remaining currents is checked. The sum of all the remaining currents is the differential current less the current under consideration. Therefore, for each, say the  $p$ th, current to be considered, the angle between the  $I_p$  and  $I_D - I_p$  phasors is to be checked.

Ideally, during external faults, the said angle is close to  $180^\circ$  (as shown); and close to 0 degrees during internal faults.

Figure 10-1: Directional principle operation during external faults

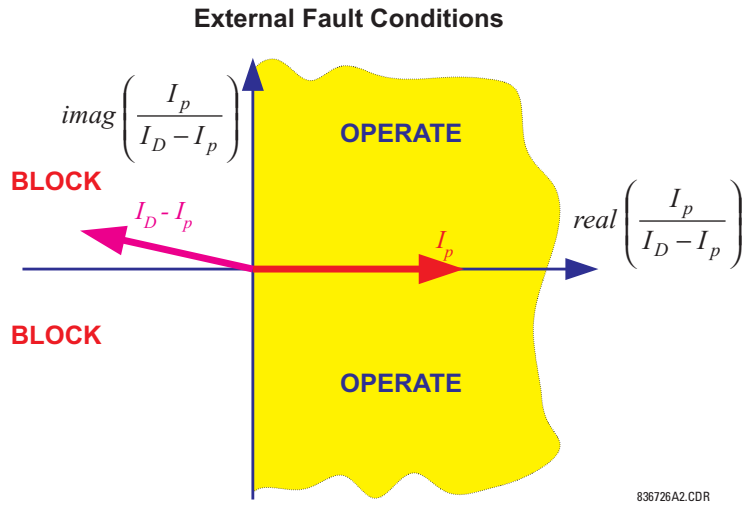
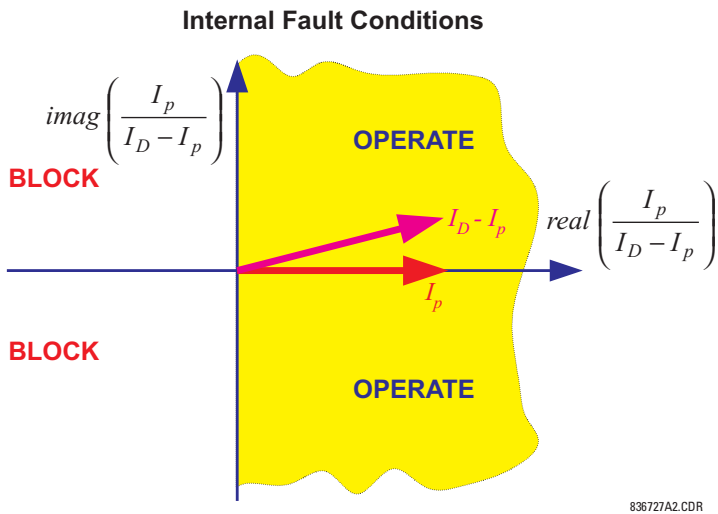


Figure 10-2: Directional principle operation during internal faults



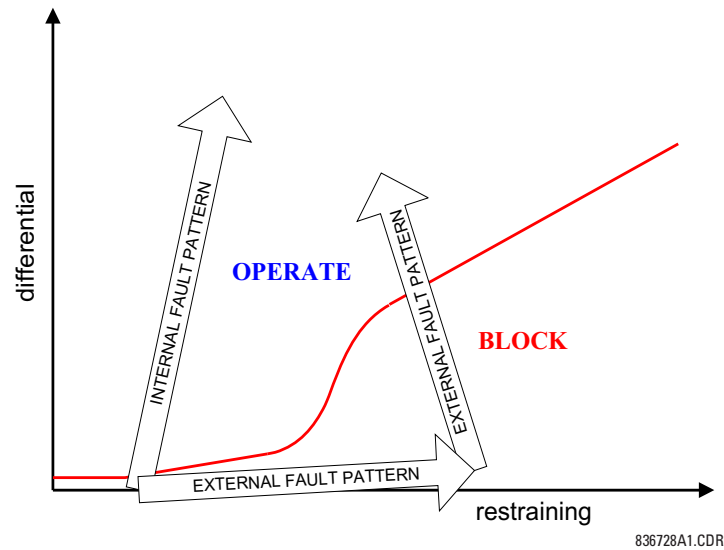
The G30 implementation calculates the maximum angle for the considered currents and compares it against a fixed threshold of 90°. The flag indicating whether the directional protection principle is satisfied is available as the FlexLogic operand `XFMR PCNT DIFF DIR A/B/C`.

## 10.2 Saturation detector

### 10.2.1 CT saturation detection

The saturation detector of the G30 takes advantage of the fact that any CT operates correctly for a short period of time, even under very large primary currents that would subsequently cause a very deep saturation. As a result, in the case of an external fault, the differential current stays very low during the initial period of linear operation of the CTs while the restraining signal develops rapidly. Once one or more CTs saturate, the differential current increases. The restraining signal, however, yields by at least a few milliseconds. During internal faults, both the differential and restraining currents develop simultaneously. This creates characteristic patterns for the differential - restraining trajectory, as shown.

Figure 10-3: CT saturation detection internal and external fault patterns



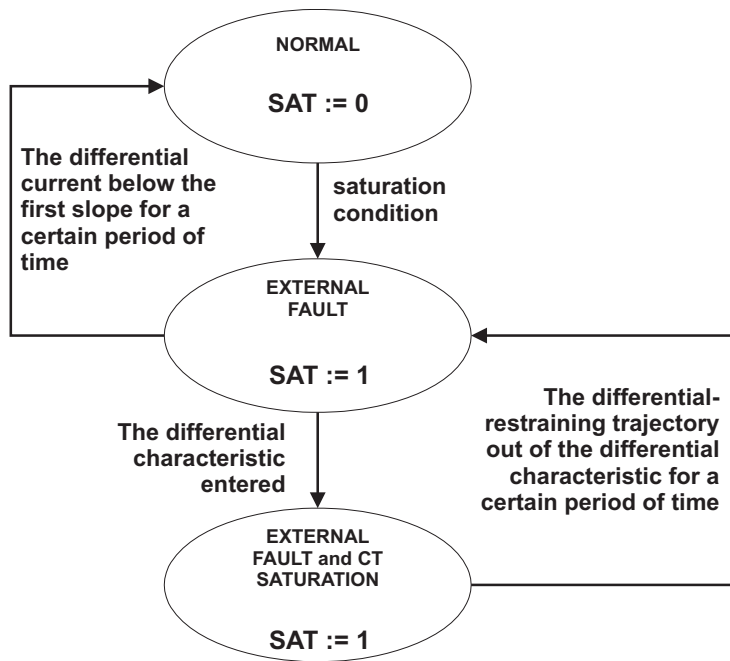
The CT saturation condition is declared by the saturation detector when the magnitude of the restraining signal becomes larger than the higher breakpoint (**HIGH BPNT**) and at the same time the differential current is below the first slope (**LOW SLOPE**). The said condition is of a transient nature and requires a seal-in. A special logic in the form of a “state machine” is used for this purpose as depicted in the following figure on saturation detector state machine.

As the phasor estimator introduces a delay into the measurement process, the aforementioned saturation test fails to detect CT saturation occurring very fast. In order to cope with very fast CT saturation, another condition is checked that uses relations between the signals at the waveform level. The basic principle is similar to that described. Additionally, the sample-based stage of the saturation detector uses the time derivative of the restraining signal ( $di/dt$ ) to better trace the saturation pattern shown in the following figure.

The saturation detector is capable of detecting saturation occurring in approximately 3 ms from fault inception. The saturation detector, although having no dedicated settings, uses the main differential characteristic for proper operation. This must be kept in mind when setting the characteristic as its parameters must retain their original meaning.

The operation of the saturation detector is available as the FlexLogic operand **XFMR PCNT DIFF SAT A/B/C**.

Figure 10-4: Saturation detector state machine



836729A1.CDR

# G30 Generator Protection System

## Chapter 11: Maintenance

This chapter outlines monitoring, maintenance, repair, storage, and disposal of the hardware and software.

### 11.1 Monitoring

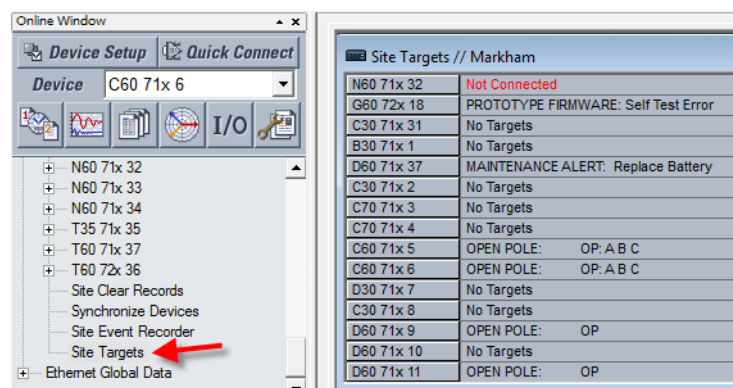
Devices and data can be monitored.

#### 11.1.1 Devices with Site Targets

To view an overview of devices:

1. Access the **Site Targets** item in the Online Window area, below the list of devices. It can take a few minutes for all devices to be read.
2. Acknowledge any messages for unaccessible devices. The Site Targets window opens when done.

Figure 11-1: Site Targets window



#### 11.1.2 Data with Modbus Analyzer

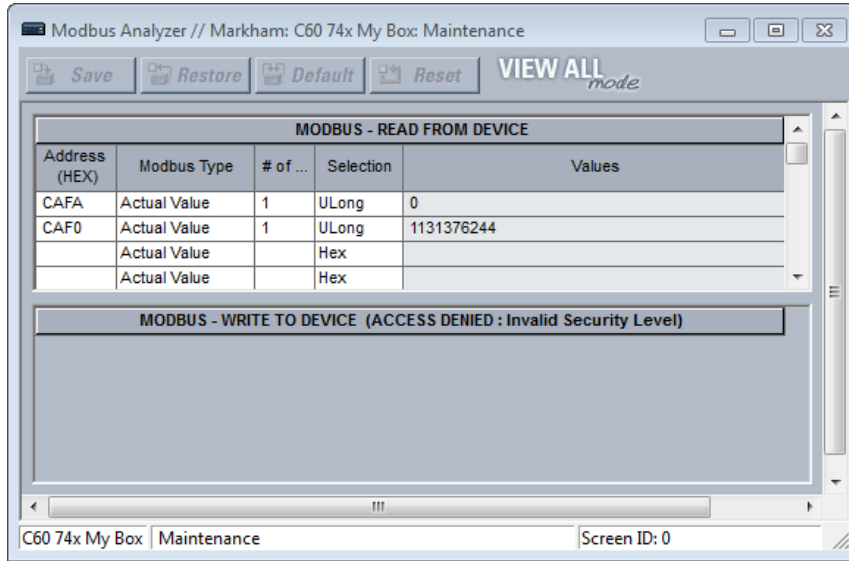
Use the Modbus Analyzer under **Maintenance > Modbus Analyzer** to monitor the values of the UR device. Use the Modbus memory map addresses outlined in the UR Family Communications Guide for the entries.

The upper part of the window displays values. The lower part of the window is for factory service use.

The first row in the figure shows that Contact Output 1 operation is being monitored. Its Modbus address is CAFA. The actual value read from the device is 0, which means that it is off.

The second row in the figure shows the Contact Output 1 Name. It has a Modbus address of CAF0 and a default value of "Cont Op 1." None of **Selection** column settings render this value because they present the information based on numbering systems.

Figure 11-2: Modbus Analyzer used to monitor actual values on a UR



**Address (HEX)** — Modbus address in hexadecimal. See the Modbus memory map in the UR Family Communications Guide or in the web interface (enter IP address of UR device in a web browser).

**Modbus Type**

- Actual Value — To read the data in the UR device
- Setting — To read a setting in the UR device
- Coil — To read a command in the UR device

**# of** — Element, input, or output to read. An example is 1 for Contact Output 1.

**Selection** (examples demonstrate various ways to represent 0)

Hex — A decimal numbering system based on 16 possible values, from 0 to 9 and A to F. An example is 0x0000.

Char — A single unicode character, such as C. An example is 0.

Int — A 32-bit number, either positive or negative. An example is 0.

UInt — Unsigned 32-bit integer, which means that it cannot be negative but can be twice as large as a signed integer. An example is 0.

Long — A 64-bit number, either positive or negative. An example is 0.

ULong — Unsigned 64-bit number, which means that it cannot be negative but can be twice as large as a signed 64-bit number. An example is 0.

Float — A numbering system with no fixed number of digits before or after the decimal point. An example is 0.000000.

Binary — A numbering system using 0 and 1. An example is 0000-0000-0000-0000.

Entries are not saved when closing the window.

## 11.2 General maintenance

The G30 requires minimal maintenance. As a microprocessor-based relay, its characteristics do not change over time. Expected service life is 20 years for UR devices manufactured June 2014 or later when applied in a controlled indoor environment and electrical conditions within specification.

While the G30 performs continual self-tests, it is recommended that maintenance be scheduled with other system maintenance. This maintenance can involve in-service, out-of-service, or unscheduled maintenance.

### 11.2.1 In-service maintenance

1. Visual verification of the analog values integrity, such as voltage and current (in comparison to other devices on the corresponding system).
2. Visual verification of active alarms, relay display messages, and LED indications.
3. LED test.
4. Visual inspection for any damage, corrosion, dust, or loose wires.
5. Event recorder file download with further events analysis.

### 11.2.2 Out-of-service maintenance

1. Check wiring connections for firmness.
2. Analog values (currents, voltages, RTDs, analog inputs) injection test and metering accuracy verification. Calibrated test equipment is required.
3. Protection elements setting verification (analog values injection or visual verification of setting file entries against relay settings schedule).
4. Contact inputs and outputs verification. This test can be conducted by direct change of state forcing or as part of the system functional testing.
5. Visual inspection for any damage, corrosion, or dust.
6. Event recorder file download with further events analysis.
7. LED Test and pushbutton continuity check.

#### **NOTICE**

To avoid deterioration of electrolytic capacitors, power up units that are stored in a de-energized state once per year, for one hour continuously.

### 11.2.3 Unscheduled maintenance (system interruption)

View the event recorder and oscillography or fault report for correct operation of inputs, outputs, and elements.

## 11.3 Retrieve files

Data, oscillography, log, events, routing, ARP, and other files can be transferred using the EnerVista software to a computer or to a USB flash drive when using the graphical front panel. These files can be requested by technical support staff.

To retrieve a file using EnerVista software:

1. If the CyberSentry option is enabled, log in to the EnerVista software using the Administrator role.
2. In the Online Window area of EnerVista, access **Maintenance > Retrieve File**. The window opens.
3. Note the destination folder to which the file is to be saved at the top and change it if required. You can copy the path or open the folder for convenience at this time.
4. Select the file to download from the UR device.

- Click the **Read File** button. The file is saved to the destination folder. The EnerVista window remains open to download additional files.

To retrieve a file using a USB drive:

- Insert the USB drive into the bottom USB port on the graphical front panel. The page displays on the front panel.
- Using the Up or Down pushbuttons on the front panel, select the file.
- Press the **COPY** pushbutton. The files are copied from the G30 to the USB drive.

**NOTICE**

Do not unplug the USB drive while copying is in progress, else the USB drive can be compromised.

- When done, to exit unplug the USB drive or press the **ESCAPE** pushbutton.

### 11.3.1 CyberSentry security event files

CyberSentry security events are available in the following two files: SECURITY\_EVENTS.CSV and SETTING\_CHANGES.LOG.

#### 11.3.1.1 Security events file

The figure shows the content for the SECURITY\_EVENTS.CSV file.

Figure 11-3: Security events file

	A	B	C	D	E	F	G	H	I	J
1	FORMAT	EVENT_INFO_1	Event Number	Data/Time	Username	IP Address	Role	Activity Value	Change Method	
2		EVENT_INFO_1	71	Feb 08 2016 10:07:20.893820	Observer	10.14.127.1	0	14	5	
3		EVENT_INFO_1	72	Feb 08 2016 10:07:20.931321	Observer	10.14.127.1	0	15	5	
4		EVENT_INFO_1	73	Feb 08 2016 10:07:41.314660	Administrator	10.14.127.1	1	14	5	
5		EVENT_INFO_1	74	Feb 08 2016 10:07:54.383404	Administrator	10.14.127.1	1	10	5	
6		EVENT_INFO_1	75	Feb 08 2016 10:07:58.187574	Administrator	10.14.127.1	1	9	5	
7		EVENT_INFO_1	76	Feb 08 2016 10:08:01.991740	Administrator	10.14.127.1	1	6	5	
8		EVENT_INFO_1	77	Feb 08 2016 10:08:42.908413	Administrator	10.14.127.1	1	6	5	
9		EVENT_INFO_1	78	Feb 08 2016 10:08:43.493822	Administrator	10.14.127.1	1	6	5	
10		EVENT_INFO_1	79	Feb 08 2016 10:09:46.908404	Administrator	10.14.127.1	1	6	5	
11		EVENT_INFO_1	80	Feb 08 2016 10:14:44.958406	Keypad	0.0.0.0	3	14	1	

**Time** — Local time.

**Activity** — The actual security event.

- 1 = Authentication Failed
- 2 = User Lockout
- 3 = FW Upgrade
- 4 = FW Lock
- 5 = Settings Lock
- 6 = Settings Change, this can fill the entire event log. Hence it is supported by the already existing SETTINGS\_CHANGE.LOG file. This event is not required.
- 7 = Clear Oscillography command
- 8 = Clear Data Logger command
- 9 = Clear Demand Records command
- 10 = Clear Energy command
- 11 = Reset Unauthorized Access
- 12 = Clear Teleprotection Counters
- 13 = Clear All Records
- 14 = Role Log out
- 15 = Role Log in

**Change Method** — Format code F229 for the settings control change method.

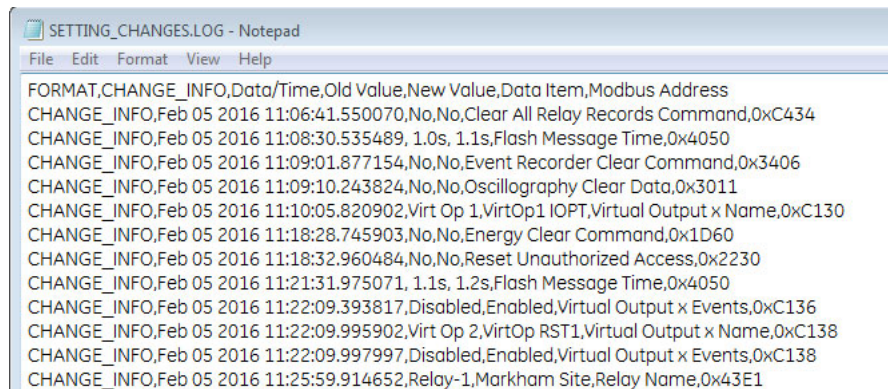


- 0 = None
- 1 = Keypad
- 2 = Front port
- 3 = COM1 (not used)
- 4 = COM2 (RS485)
- 5 = Ethernet

### 11.3.1.2 Setting changes file

The SETTING\_CHANGES.LOG file stores all the setting changes. A total of 1024 events are stored in a circular buffer in non-volatile memory.

Figure 11-4: Setting changes file



## 11.4 Convert device settings

Settings files can be upgraded or downgraded to other firmware versions. For example, version 7.4 settings can be upgraded to version 7.6.

Settings are reset to factory default upon conversion. For a graphical front panel, for example when upgrading from version 7.6 to 7.7, single-line diagrams and cells configured for the Metering Editor are defaulted, while other graphical front panel settings are retained.

When converting a settings file from version 7.20 or earlier to 7.70 or later, any IEC 61850 settings are defaulted, and Edition 2 is used.

When converting a settings file from version since 7.30 inclusive to 7.70 or later, any IEC 61850 settings are converted and Edition 2 is used.

To convert settings:

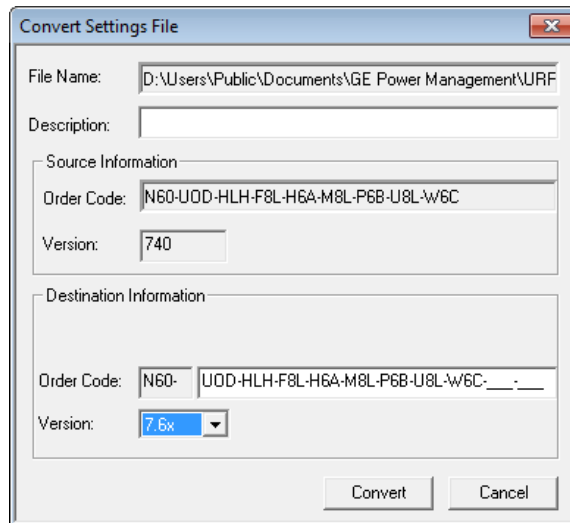
1. If not already in the Offline Window area, right-click the online device in the EnerVista software and select the **Add Device to Offline Window** option. This copies the settings to the Offline Window area. Any message about file repair usually means that settings were missing in the original file and have been added with default values to the new file.
2. Make a copy of the settings file in the Offline Window area by right-clicking the file and selecting **Duplicate Device**. A copy of the file is made and the file name start with "Copy of." Optionally rename the file by right-clicking it and selecting the **Rename Device** option.
3. Convert the settings by right-clicking one of the files in the Offline Window and selecting the **Convert Device Settings** option.

If the option does not display, click the **Admin > User Management** menu item and enable the **Update Info** check box for the user. Save.

Or if the option does not display, click the **Admin > User Management** menu item and enable the **Enable Security** check box. Save. Select the **Admin > User Login** menu item. Enter "Administrator" for the user and enter the password. (Contact GE Grid Solutions if you do not know the default password.)

GE recommends converting settings in firmware steps, for example when converting from 6.0 to 7.4x, convert first to 7.0 then 7.4 in order to follow embedded conversion rules and keep settings. The settings convert and a report generates.

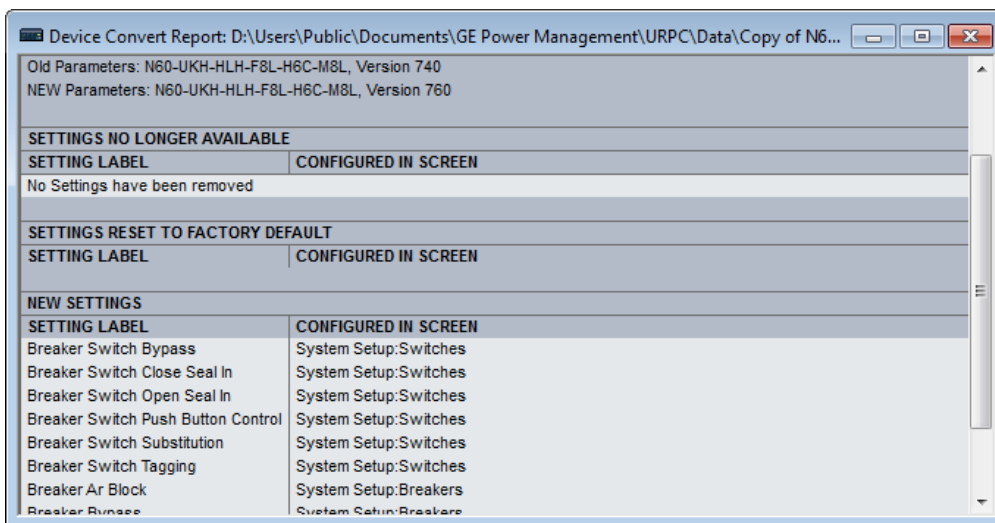
Figure 11-5: Upgrade settings



- Review the conversion report. The values of all settings that have been defaulted during conversion are not listed in the conversion report; to find the value of a setting before conversion, inspect the device backup file made before conversion.

In the example shown here, settings have been reset to factory defaults and several settings are new in firmware version 7.6 under **Settings > System Setup > Switches and Breakers**.

Figure 11-6: Conversion report



- Change settings in the new file, for example by looking at the original file.
- Write the converted file to the device, for example by dragging and dropping from the Offline Window to the Online Window.
- Check settings and operation.

---

## 11.5 Copy settings to other device

Settings from one G30 device can be copied to another G30 device for rapid deployment. The order codes and IEC 61850 edition must match. See the Settings File section at the beginning of the Interfaces chapter for a list of settings not deployed.

To apply settings to another device:

1. Right-click the device in the Online window and select the **Add Device to Offline Window** option. A window opens.
2. Check the file path and name the file, then click the **Receive** button. An example is to save the files in D:\Users\Public\Public Documents\GE Power Management\URPC\Data\ and to name the source device G30\_Deployment. At the prompt, confirm the action. The settings are saved in .cid, .icd, and .urs files, and the entry displays in the Offline window area.
3. Right-click the device in the Offline window area and select the **Duplicate Device** option. The device is copied with a prefix of "Copy of." Multiple duplicates results in files being named "Copy of Copy of" for example, which can be avoided by deleting the folder copies from the path shown on mouse-over.
4. Right-click the copied device and rename it.
5. Right-click the copied device and select the **Edit Device Properties** option. Make the changes for the new device.
6. Send the file to new device by dragging and dropping it into the Online Window area. Or right-click and select the **Write Settings to Device** option.
7. Update the remaining settings, such as IP address.

---

## 11.6 Copy settings to other device

Settings from one G30 device can be copied to another G30 device for rapid deployment. The order codes and IEC 61850 edition must match. See the Settings File section at the beginning of the Interfaces chapter for a list of settings not deployed.

To apply settings to another device:

1. Right-click the device in the Online window and select the **Add Device to Offline Window** option. A window opens.
2. Check the file path and name the file, then click the **Receive** button. An example is to save the files in D:\Users\Public\Public Documents\GE Power Management\URPC\Data\ and to name the source device G30\_Deployment. At the prompt, confirm the action. The settings are saved in .cid, .icd, and .urs files, and the entry displays in the Offline window area.
3. Right-click the device in the Offline window area and select the **Duplicate Device** option. The device is copied with a prefix of "Copy of." Multiple duplicates results in files being named "Copy of Copy of" for example, which can be avoided by deleting the folder copies from the path shown on mouse-over.
4. Right-click the copied device and rename it.
5. Right-click the copied device and select the **Edit Device Properties** option. Make the changes for the new device.
6. Send the file to new device by dragging and dropping it into the Online Window area. Or right-click and select the **Write Settings to Device** option.
7. Update the remaining settings, such as IP address.

---

## 11.7 Compare settings

Settings are comparable against default values and between two UR devices.

Some of the IEC 61850 settings use floating point data, which guarantees accurate representation of real numbers up to seven digits. Numbers with more than seven digits are approximated within a certain precision. This can result in differences between what is entered and what is saved, and for example results in differences shown on a settings comparison report.

When comparing two settings files with the graphical front panel, all graphical front panel features are compared except for the single-line diagrams.

### 11.7.1 Compare against defaults

To compare settings against default values:

1. Right-click the device in the Offline Window area and select **Compare Settings With Defaults**. The file generates and the number of differences displays.
2. To save the report, click **File > Save As**, select the TXT, PDF, or CSV format from the drop-down list, and enter a name for the file.

In the figure, the first entry (red) is from the device, while the second (green) is the default value.

Figure 11-7: Device settings compared with default values

#		Setting Name	Group	Module	Item	Value
1	-	Contact Input Debounce Time	1	1	1	2.0 ms
2	+	Contact Input Debounce Time	1	1	1	6.0 ms
3	-	Contact Input Debounce Time	1	2	1	2.0 ms
4	+	Contact Input Debounce Time	1	2	1	6.0 ms
5	-	Contact Input Debounce Time	1	3	1	2.0 ms
6	+	Contact Input Debounce Time	1	3	1	6.0 ms

### 11.7.2 Compare two devices

Preferences are set under **File > Preferences** as follows:

- **Comparison Report: Sequential File 1, File 2 Layout** — When disabled (default), the report shows only what differs, as shown in the previous figure. When enabled, the report indicates differences by device.

Figure 11-8: Device settings compared between two devices, displayed sequentially

```

1, File2 , Existing 7.40 IEC61850 settings removed., ____, New IEC61850 settings added with default values.
2, File2 , Bkr Phase A Open, 1__1__1, 0 (OFF)
3, File2 , Bkr Phase B Open, 1__1__1, 0 (OFF)
4, File2 , Bkr Phase C Open, 1__1__1, 0 (OFF)
5, File2 , Breaker Restrike Block, 1__1__1, 0 (OFF)
6, File2 , Breaker Restrike Block, 1__2__1, 0 (OFF)
7, File2 , Breaker Restrike Brk Open, 1__1__1, 0 (OFF)
8, File2 , Breaker Restrike Brk Open, 1__2__1, 0 (OFF)
9, File2 , Breaker Restrike CIs Cmd, 1__1__1, 0 (OFF)
10, File2 , Breaker Restrike CIs Cmd, 1__2__1, 0 (OFF)
    
```

There are two ways to compare devices: devices in the Offline area or between Online and Offline devices.

To compare settings of two devices in the Offline Window area:

1. Right-click a first device in the Offline Window area and select **Compare Two Devices**.
2. In the window that opens, select a second device and click the **Receive** button. The file generates and the number of differences displays.
3. To save the report, click **File > Save As**, select the TXT, PDF, or CSV format from the drop-down list, and enter a name for the file.

To compare settings between Online and Offline devices:

1. Right-click a device in the Online Window area and select **Compare with Device**.

2. In the window that opens, enter a path/file name at the bottom of the window.
3. Select the second device.
4. Click the **OK** button. The file generates, and the differences are highlighted in red, which is for the first device.

## 11.8 Back up and restore settings

Back up a copy of the in-service settings for each commissioned UR device, so as to revert to the commissioned settings after inadvertent, unauthorized, or temporary setting changes are made, after the settings defaulted due to firmware upgrade, or when the device has to be replaced. This section describes how to backup settings to a file and how to use that file to restore the settings to the original relay or to a replacement relay.

For reference, settings can be saved with **Online > Print Device Information** and **Online > Export Device Information**. They cannot be restored using these options.

### 11.8.1 Back up settings

The following file types can be saved:

- URS — UR settings file — When the IEC 61850 option is not present
- IID — Instantiated IED capability description file — Actual settings on UR
- ICD — IED Capability Description file — Default settings on UR
- CID — Configured IED description file — Settings sent to the UR (may or may not contain the present settings)

UR device settings can be saved in a backup URS file using the EnerVista UR Setup software. The URS file is the standard UR settings file. For an introduction to settings files in the URS format, see the beginning of the Interfaces chapter.

When the IEC 61850 option is present, the settings can be saved alternatively in a backup IID file either using the EnerVista UR Setup software in online mode or by using any of the supported file transfer protocols. The IID file is one of several IEC 61850 Substation Configuration Language (SCL) file types; see the IEC 61850 chapter in the UR Series Communications Guide for an introduction to SCL.

"TBD" displays when a setting in a modeled element is configured with a non-modeled operand. For example, Phase IOC is modeled in a firmware release, while the LED operands are not modeled. If the block setting of the Phase IOC is configured with LED operands, it displays as TBD in IID and CID files, the web interface, or in an MMS client.

The options that display in the EnerVista software when right-clicking depend on device options.

Preferences are set in the **File > Preferences > IEC 61850** menu. There are two options as follows:

- **Preserve custom attributes when importing SCD/CID files** — Applies to the **Add Device to Offline Window** option. When enabled, the IID file also is to be copied to the computer. The IID file that is retrieved from the relay is therefore assumed to be in synchronization with the resulting .urs file, and in fact in this situation the IID file on the computer is a copy of the IID file that was read from the online device. When disabled, the IID file on the computer is to be left unchanged. The location of the IID file is C:\ProgramData\GE Power Management\urpc\Offline, for example.
- **Do not update IID file when updating SCL files** — When enabled (default), an IID file is not to be created on the computer and if one is already present there, it is neither removed nor updated. Have this option enabled when you want to keep the IID file from the UR device instead of from another tool. The location of the file is C:\ProgramData\GE Power Management\urpc\Offline, for example.

An Environment backup stores a list of sites and devices in the Online and Offline Window areas. Settings files are not contained within the environment file. If a settings file is moved, renamed, or deleted after the backup, it is removed from the Offline Window during the restore.

To save a settings file in the URS format in EnerVista Online Window:

1. In EnerVista, connect to the device in the Online Window area.
2. Right-click the device name in the Online Window area and select **Add Device to Offline Window**. A window opens.
3. Select or enter a file name and location, and click the **Receive** button. A .urs file is created in the Offline Window area.

To create a new settings file in the URS format in EnerVista Offline Window:

1. In EnerVista, right-click in the Offline Window area and select **New Device**. A window opens.
2. Change the file name at the end of the **Path** field, keeping the .urs extension.
3. From the **Associate File with Device** drop-down list, select the UR device. Other fields complete automatically. Otherwise, when you do not select a device from the drop-down list, all fields need to be completed manually and only devices that match the entered order code and version display in the list.
4. The **Serial # Lock** field is the serial number of the intended device. It ensures that the settings file is sent only to the specific relay that matches the serial number.
5. Click the **OK** button to create the .urs file in the Offline Window area.

To save settings in the IID format in EnerVista Online Window:

1. In EnerVista, connect to the device in the Online Window area.
2. Right-click the device name in the Online Window area and select **Read IID File**. The option is not present when the device does not have the IEC 61850 option. A window opens when successful.
3. Select or enter a file name and location, and click the **Receive** button. A .iid file is created.

To save settings in the IID format in EnerVista Offline Window:

1. In EnerVista, right-click the device in the Offline Window area.
2. Select the **Create IID File** option for firmware below 7.3. The option is not always available. Select the **Save As** option for firmware 7.3 and later, and select the IID option from drop-down list.  
No file is generated. The IID file on the computer is copied to the location specified.
3. If the **Do not update IID file when updating SCL files** preference is enabled under **File > Preferences > IEC 61850**, then a message displays to that effect. This means that there is no IID file available on the computer to be copied, so a new one is generated.

To save settings in the IID format using TFTP:

1. On a computer on the same subnetwork as the UR device, open a command window.
2. Enter

```
TFTP <IP address> GET ur.iid <destination>
```

where

<IP address> is the IP address of the UR device

ur.iid is the internal name of the IID file in the UR device

<destination> is the path and file name of the IID file. If omitted, the file is saved as ur.iid in the command window default directory.

An example is

```
TFTP 192.168.1.101 GET ur.iid Feeder1.iid
```

To save settings in the ICD format in EnerVista Online Window:

1. In EnerVista, right-click the device in the Online Window area.
2. Select the **Read ICD File** option. A window opens.
3. Enter a path/name for the file, and click the **Save** button.

To save settings in the ICD format in EnerVista Offline Window:

1. In EnerVista, right-click the device in the Offline Window area.

2. Select the **Create ICD File** option. Or select the **Save As** option, and select the ICD option from drop-down list.  
You can be prompted to specify if the file is for firmware version 7.12 or later.  
The file is saved to the location specified.

To save settings in the CID format in EnerVista Online Window:

1. In EnerVista, right-click the device in the Online Window area.
2. Select the **Read ICD File** option. A window opens.
3. Enter a path/name for the file, and click the **Save** button.

To save settings in the CID format in EnerVista Offline Window:

1. In EnerVista, right-click the device in the Offline Window area.
2. Select the **Save As** option, which displays for firmware 7.3 and later, and select the CID option from the drop-down list.  
The file is copied from the computer to the location specified.

To save list of sites and devices with an Environment backup:

1. In EnerVista, click **File > Environment > Backup**. A window opens.
2. Name and save the .ENV file.

## 11.8.2 Restore settings

UR device settings can be restored to the values they were at when a URS backup file was created using the EnerVista UR Setup software. When the IEC 61850 option is present, the settings can alternatively be to the values they were at when an IID type backup was created either using the EnerVista UR Setup software in online mode or by using any of the supported file transfer protocols. Note that TFTP cannot be used here, as TFTP "put" mode is disabled for security reasons.

To restore completely, a few settings need to be entered manually either via EnerVista UR Setup or via the UR device front panel. If the restore operation is to be via Ethernet, first the UR device must have its IP address settings entered via the front panel. These are located at **SETTINGS ⇒ PRODUCT SETUP ⇒ COMMUNICATIONS ⇒ NETWORK 1(3)** and **SETTINGS ⇒ PRODUCT SETUP ⇒ COMMUNICATIONS ⇒ IPv4 ROUTE TABLE 1(6) ⇒ DEFAULT IPv4 ROUTE ⇒ GATEWAY ADDRESS**.

When importing a file, it cannot have a blank numeric value. All numeric values must be non-blank, otherwise the file is rejected.

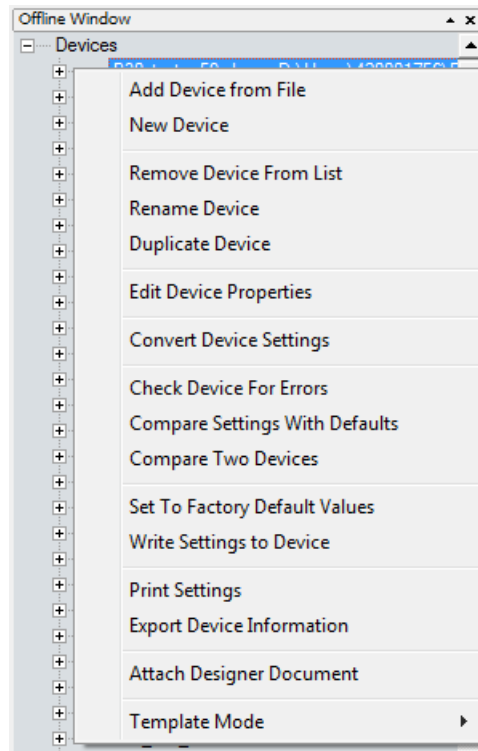
URS and IID procedures are outlined here.

To restore settings from a URS file:

1. In EnerVista, connect to the device in the Online Window area.
2. Right-click the .urs file in the Offline Window area and select **Add Device from File** to locate a file, and/or drag-and-drop the file from the Offline Window area to the device in the Online Window area.



Figure 11-9: Restoring a URS settings file



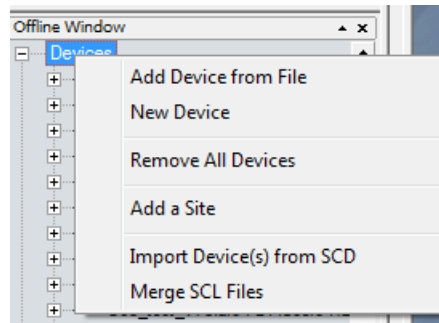
3. Two prompts are possible, first that the URS file does not include the complete IEC 61850 configuration and that it needs to be recreated if you continue. This means that the URS file is from UR version 7.30 or higher, has the IEC 61850 software option in the order code, but any IEC 61850 content will be compromised and will need to be configured. Second, a message can display that the URS file is part of a device folder and to use the device's CID file. This means that the URS file is from UR version 7.3 or higher, has the IEC 61850 software option in the order code, and is part of the device folder. The user is trying to add a URS file from inside a device's folder. Instead, the user needs to use the CID file from the device folder. These messages display because the roles of the protection engineer and network engineer can be separate. The former can require a URS file, while the latter can require stored Modbus settings and protection schemes.
4. Manually copy the remaining settings, outlined as follows.

To restore settings from an IID file using EnerVista software:

1. In Windows, make a copy the IID file with a cid extension.
2. Connect to the device in the Online Window area.
3. In the Offline Window area, right-click **Devices** and select **Import Devices from SCD**.



Figure 11-10: Importing an SCD or CID file



4. Navigate to and select the file with .cid extension. When prompted, enter a file name to give to an intermediate URS file. The URS file is added to the Offline Window area.
5. Drag the imported file in the Offline Window to the device in the Online Window. Note that the **RELAY SETTINGS** value also is written to a device, and the accepting relay is put into "Programmed" or "Not Programmed" mode as configured in the offline file.
6. Manually copy the remaining settings, outlined as follows.

To restore settings from an IID using SFTP:

1. In Windows, make a copy the IID file with a cid extension.
2. On a computer on the same subnetwork as the UR device, open a SFTP client application, such as WinSCP. Note that TFTP cannot be used here.
3. Use the device's IP address as the host name.
4. If the device has the CyberSentry option, use the User Name of "Administrator" or "Engineer", and the password programmed for the selected role. The default password is "ChangeMe1#" (without quotation marks).
5. If the device does not have the CyberSentry option, use the User Name of "Setting", and the password programmed for the Setting role. The default password is "ChangeMe1#" (without quotation marks).
6. Upload the backup file copy with the CID extension. WinSCP uses drag-and-drop or copy-and-paste for this.
7. Manually copy the remaining settings, outlined as follows.

To manually copy remaining settings:

1. Settings listed in section 4.1.2 Settings Files are not transferred to the UR device with settings files. Enter them manually either via the front panel or via EnerVista UR Setup software. The values that these settings had at the time the backup was created are contained within the backup file, accessed through EnerVista UR Setup software.

To restore the list of sites and devices from an Environment backup:

1. In EnerVista, click **File > Environment > Restore**. A window opens.
2. Select the .ENV file to restore.

## 11.9 Upgrade software

In general, the latest releases of the EnerVista software can be used with all firmware versions. For example, EnerVista software released for UR 7.4 can be used to access multiple UR devices that have version 7.4x, 7.2x, and 6.0x firmware installed.

Existing installations do not need to be uninstalled before upgrade.

You can also downgrade the software; use the same procedure.

To upgrade the EnerVista software:

1. If a beta version of the EnerVista UR Setup software is installed, uninstall it, for example using the Windows Control Panel.
2. For Windows 10, disconnect any USB cable to the G30, else the UR USB drivers do not install correctly.
3. Download the latest EnerVista software and/or firmware from <http://www.gegridsolutions.com/app/ViewFiles.aspx?prod=urfamily&type=7>
4. Double-click the file and complete the wizard. The software installs.
5. Access the software and check the version number under **Help > About**. If the new version does not display, try uninstalling the software and reinstalling the new versions.
6. For Windows 10, to finish installing the UR USB driver, open **Device Manager > Ports**, then plug in the USB cable (to connect the relay and computer). A new port starting with "GE Virtual Serial Port" is available. If available, click the **OK** button to complete the installation.

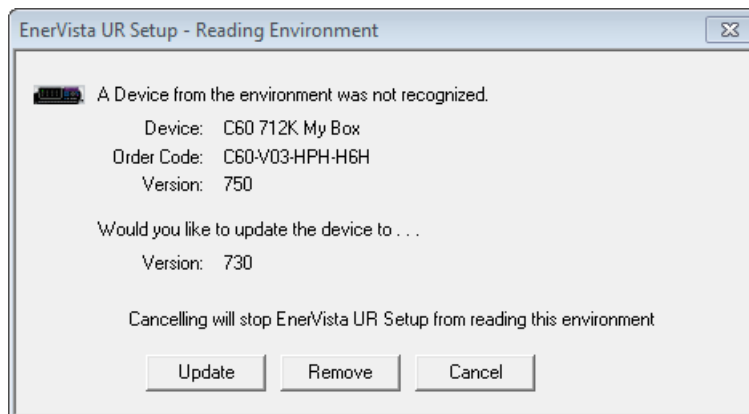
If not available, uninstall the existing GE USB driver in the **Device Manager > Ports**. (Right-click and "Uninstall.")

When complete, unplug and re-plug the USB cable connecting the UR device. The "GE Virtual Serial Port" driver is now available.

A message can display about a version not being supported. An example is when upgrading from version 7.12K to 7.4x. The 7.12K entry is removed from the Offline Window area.

A message can display in the EnerVista software upon launch that "a device from the environment was not recognized." This means that a device is online and its firmware version conflicts with the software version. In the example shown, a C60 with firmware version 7.5x is online, but the software version is 7.3x. Updating removed incompatible files and changed the device to version 7.3x, after which you need to make the order codes consistent as outlined next.

**Figure 11-11: Mismatch in order code between software and device**



To make the order codes consistent:

1. In EnerVista, click the **Device Setup** button. The window opens.
2. Expand the entry for the UR device.
3. Click the **Read Order Code** button. The order code and version of the device are populated to the software.
4. Click the **OK** button to save the change.

## 11.10 Upgrade firmware

If upgrading both EnerVista software and G30 firmware, upgrade the software first.

The firmware of the G30 device can be upgraded, locally or remotely, using the EnerVista software.

Upgrades are possible for the same release (such as 7.01 to 7.02) and from one firmware version to another (such as 7.2 to 7.3). When upgrading to another firmware version, check the release notes on the GE Multilin website for compatibility.

If you are upgrading from version 7.0 or 7.1 to 7.2 or later, some CPU modules require a new boot version. Update this first. Address equipment mismatch error before upgrade. For example, if you have a basic front panel attached and the order code in the device is for a graphical front panel, the upgrade only works with a graphical front panel.

You can also downgrade firmware; use the same procedure.

To upgrade the firmware using EnerVista software:

1. If required, download the boot file and/or firmware from <http://www.gegridsolutions.com/app/ViewFiles.aspx?prod=urfamily&type=7>  
The firmware and boot files are .bin files.
2. Navigate to **Settings > Product Setup > Security** and ensure that the **Remote Setting Authorized** and **Local Setting Authorized** settings are "ON." On the front panel of the device, the path is **SETTINGS ⇒ PRODUCT SETUP ⇒ SECURITY ⇒ DUAL PERMISSION SECURITY ACCESS**.  
If using CyberSentry security, also ensure that the relay and firmware are not locked under the **Settings > Product Setup > Security > Supervisory** settings. A Supervisor role is required for these settings.
3. In EnerVista, back up the device settings by right-clicking the device and selecting **Add Device to Offline Window**. In the window that displays, select an existing file to overwrite, or enter a name for a new settings file and optionally a location for the new file. Click the **Receive** button to start the backup.  
If an "Incompatible device order codes or versions" message displays, it means that you are trying to overwrite a file for another product. You access the **Convert Device Settings** option by right-clicking the file in the **Offline Window** area at the lower left. GE recommends converting settings in firmware steps, for example when converting from 6.0 to 7.4x, convert first to 7.0 then 7.4 in order to follow embedded conversion rules and keep settings. Note that the values of all settings that have been defaulted during conversion are not listed in the conversion report; to find the value of a setting before conversion, inspect the device backups made before conversion.
4. In EnerVista, navigate to **Maintenance > Update Firmware**.  
First select the boot file if applicable, locating the .bin file, and proceed. Restart the device, the EnerVista software, and refresh the order code in EnerVista under the **Device Setup** button.  
To update the firmware, click **Maintenance > Update Firmware**, select the firmware update by locating the .bin file, and proceed with the update.  
When asked if upgrading over the Internet, the difference is the flash memory buffer size each time the software sends data to the relay. Yes means that the flash memory buffer size is 256 bytes. No means that it is 1024 bytes, which is faster.  
If a warning message displays about the firmware not being supported by the EnerVista software, it means that the firmware is a later version than the software. Upgrade the software to the same or later version as the firmware, then try again.  
If an "Unable to put relay in flash mode" message displays, set the **Settings > Product Setup > Security > Dual Permission Security Access > Remote Setting Authorized** and **Local Setting Authorized** settings to "ON" and try again.  
When the update is finished, the relay restarts automatically. The upgrade process takes about 20 minutes when using a graphical front panel because of writing to the front panel.
5. Restart the EnerVista software, and refresh the order code in EnerVista under the **Device Setup** button.
6. Verify the boot and firmware version while the device is starting up or in EnerVista under **Actual Values > Product Info > Firmware Revisions**. The boot revision is not the same as the firmware revision, and the firmware revision reflects the UR release, for example firmware revision 7.40 is UR release 7.40.
7. Set the device to "programmed" under **Settings > Product Setup > Installation**. A self-test error displays on the device until this is done.
8. If you changed the **Remote Setting Authorized**, the **Local Setting Authorized** settings, or relay lock settings, return them to their previous settings.
9. To apply any previously saved settings, right-click the saved settings file in the **Offline Window** area and select **Write to Device**. Optionally convert the saved settings to the new firmware version before writing to the device by right-clicking and selecting **Convert Device Settings**.



The field-programmable gate array (FPGA) can be upgraded under **Maintenance > Update FPGA** when the device is connected via serial cable and the firmware revision is 7.0 or higher.

Modbus addresses assigned to firmware modules, features, settings, and corresponding data items (that is, default values, minimum/maximum values, data type, and item size) can change slightly from version to version of firmware. The addresses are rearranged when new features are added or existing features are enhanced or modified. The EEPROM DATA ERROR message displayed after upgrading/downgrading the firmware is a resettable, self-test message intended to inform users that the Modbus addresses have changed with the upgraded firmware. This message does not signal any problems when appearing after firmware upgrades.

## 11.11 Replace front panel

This section outlines how to install a graphical front panel.

A graphical front panel with a seven-inch (17.8 cm) color display and USB port is available for horizontal units. When purchased separately as a retrofit for an existing relay, there is one kit for an enhanced front panel replacement and another kit for the basic front panel replacement, with mounting brackets differing between the two kits. A kit includes the graphical front panel, mounting brackets, and screws. The graphical front panel requires CPU module type W or module type T, U, or V (newer type that has two connector slots on the front of the module--the second is difficult to see), upgrades of software and firmware, then a settings update to recognize the graphical front panel.

The graphical front panel can replace a basic front panel on newer models where the hinges are not riveted to the chassis. It cannot replace a basic front panel where the hinges are riveted onto the chassis; both front panel and chassis require replacement. See the photo of the riveted hinges later in this section.

The following procedures are outlined:

- Remove front panel
- Install graphical front panel
- Replace CPU module
- Upgrade software and firmware, then update setting



**Withdraw or insert a module only when control power has been removed from the unit, and be sure to insert only the correct module type into a slot, else personal injury, damage to the unit or connected equipment, or undesired operation can result.**



To avoid damage to the equipment, use proper electrostatic discharge protection (for example, a static strap) when coming in contact with modules while the relay is energized.

The following procedure can be used for the Rev. 1 and Rev. 2 enhanced front panels, with Rev. 1 is documented here. The Rev. 2 enhanced horizontal front panel introduced starting November 2017 uses a screw to close it and internal hinge screws as per the graphical front panel.

To remove an enhanced or basic front panel:

1. In the EnerVista software or on the front panel, access **Settings > Product Setup > Communications > Network** and record the IP address and subnet mask of the port(s) being used. Record the gateway address under **Default IPv4 Route**.
2. Turn off power to the unit. Hot-swapping of the front panel is not supported.
3. For an enhanced front panel, loosen the thumb screw and open slightly the front panel.  
For a basic front panel, lift up the black plastic latch on the right side of the front panel and open slightly the front panel.

Figure 11-12: Loosen thumb screw on enhanced front panel to open



Figure 11-13: Lift latch on basic front panel to open



4. With a Phillips screwdriver, unscrew and remove the mounting bracket on the right side of the unit. The bracket for the enhanced front panel looks similar to that for the graphical front panel, but they are not the same.

Figure 11-14: Remove enhanced front panel mounting bracket on right side



Figure 11-15: Remove basic front panel mounting bracket on right side



5. Open the front panel. Unplug or unscrew the grey ground cable from the front panel. Unplug the RJ45 connector from the CPU module in the second slot on the left.



Figure 11-16: Disconnected ground cable and CPU connector



6. Unscrew and remove the mounting bracket with the front panel from the left side.

Figure 11-17: Unscrew enhanced front panel mounting bracket on left side



Figure 11-18: Unscrew basic front panel mounting bracket on left side

(note riveted hinges with red arrows - cannot replace this front panel)



The front panel has been removed.

To install the graphical front panel:

1. With power to the unit off, screw the left mounting bracket to the outside of the relay. The power supply module can remain in the first slot.

**Figure 11-19: Attach mounting bracket to relay on left side (no power supply module in first slot)**



2. Screw the right mounting bracket to the right side of the relay.



Figure 11-20: Attach mounting bracket to relay on right side



3. Attach the graphical front panel hinge to the left mounting bracket using the nuts provided.

Figure 11-21: Attach to left mounting bracket inside relay



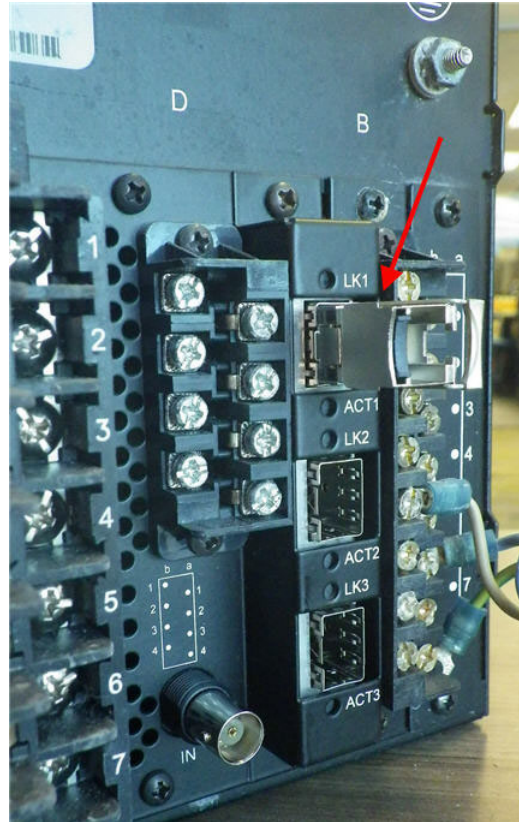
4. Close the front panel without tightening the screw to the mounting bracket.
5. Optionally remove the protective plastic film on the graphical front panel. It is normally peeled off, but also can be left on.

The graphical front panel has been installed but not connected.

To replace the CPU module:

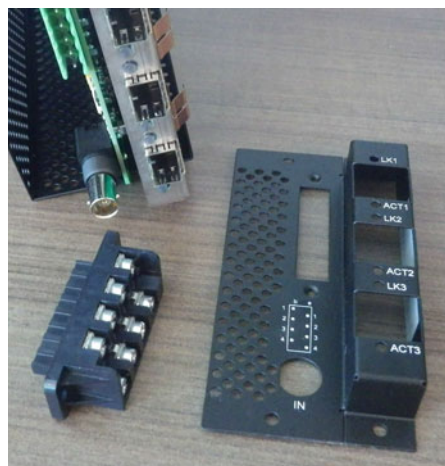
1. With power to the unit off, at the back of the CPU module in the second slot, disconnect any cables. Remove the silver SFP connector(s) from the CPU module, and keep it handy. Then remove the CPU module by sliding the module out from the front of the relay. (See the next section for instructions.)

**Figure 11-22: Remove silver SFP connector (shown here under LK1 label)**



2. At the front of the relay, insert the new CPU module in the second slot. The new CPU has two connection slots on the front. Ensure that the RS485 connector and the black cover plate are not on the back of the CPU module before sliding the module into the front of the relay.

**Figure 11-23: Rear of a CPU module before insertion without RS485 connector or cover plate**



3. Once the module is in place, connect the graphical front panel to the CPU module (ground and upper connector) and close the front panel. There are two connections possible on the front of the CPU module: upper for the graphical front panel and lower for the enhanced and basic front panels. The upper connection is black with holes, similar to the cover, so it is difficult to see.

**Figure 11-24: Connect graphical front panel to top connection on CPU module**



4. Tighten the embedded screw on the right side of the graphical front panel to the mounting bracket.

**Figure 11-25: Screw to attach graphical front panel to mounting bracket**



5. At the back of the CPU module, attach the new black cover plate to the back of the relay, then connect the new RS485 connector.  
Insert the silver SFP connector(s) at the back of the CPU module, then connect any Ethernet connection(s).
6. Power up the relay. If the graphical front panel does not power up immediately, disconnect power, open the front

panel, then check that the graphical front panel is plugged into the upper connection, not the lower silver connection on the CPU module.

## 11

To upgrade software and firmware.

1. Upgrade the EnerVista software as outlined in this chapter.
2. Input the IP address and subnet mask of the relay on the front panel under **Settings > Product Setup > Communications > Network**, and input the gateway address under **Default IPv4 Route**.
3. Upgrade the firmware in the EnerVista software as outlined in this chapter, for example under **Maintenance > Update Firmware**.

If you see error messages after the upgrade, disconnect power to the relay and shut down the software, then start both again. If you see a flashing message about front panel communications trouble, check the connection of the graphical front panel to the CPU module.

4. In the EnerVista software, click the **Device Setup** button and refresh the order code for the device.
5. Set the relay to Programmed mode under **Settings > Product Setup > Installation**.
6. Update the EnerVista software to recognize the graphical front panel under **Maintenance > Change Front Panel**. This setting does not display for units already with a graphical front panel.

If an equipment mismatch error displays on the front panel, it can mean that the order code on the device needs to be updated to the new front panel.

## 11.12 Replace module

This section outlines how to replace a module.



**WARNING** Withdraw or insert a module only when control power has been removed from the unit, and be sure to insert only the correct module type into a slot, else personal injury, damage to the unit or connected equipment, or undesired operation can result.

### NOTICE

To avoid damage to the equipment, use proper electrostatic discharge protection (for example, a static strap) when coming in contact with modules while the relay is energized.

The relay, being modular in design, allows for the withdrawal and insertion of modules. Replace modules only with like modules in their original factory configured slots.

Two procedures follow: replace a module with the same module, and upgrade a module.

To replace a module with the same module:

1. Open the enhanced front panel to the left once the thumb screw has been removed. This allows for easy access of the modules for withdrawal. The new wide-angle hinge assembly in the enhanced front panel opens completely and allows easy access to all modules in the G30.

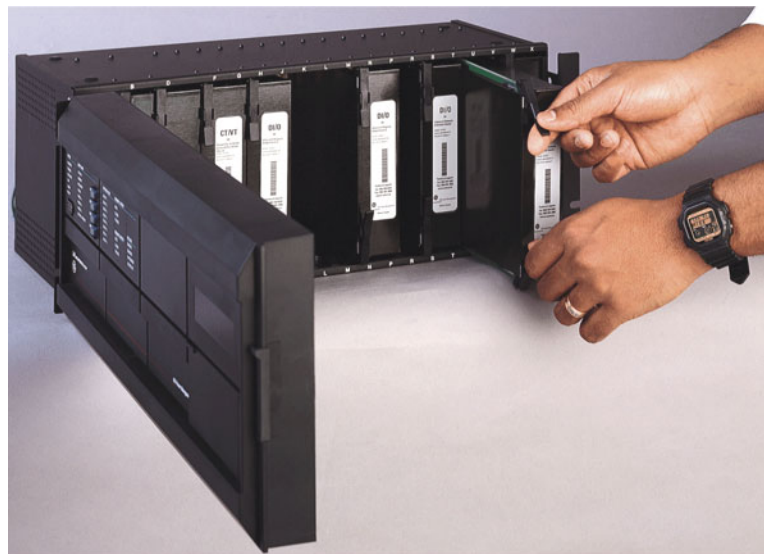
Figure 11-26: Modules inside relay with front cover open (enhanced front panel)



842812A1.CDR

The basic front panel can be opened to the left once the black plastic sliding latch on the right side has been pushed up, as shown below.

Figure 11-27: Removing module (basic front panel)



842760A1.CDR

2. With power to the unit off, disconnect individually the connections at the front and back of the module before removing the module from the chassis.  
For any Process Card/process bus module in slot H for use with a HardFiber Brick, also remove the two screws at the back that attach the module to the chassis.
3. To properly remove a module, pull simultaneously the ejector/inserter clips, located at the top and bottom of the module. Record the original location of the module to ensure that the same or replacement module is inserted into the correct slot. While modules with current input provide automatic shorting of external CT circuits, for CT/VT modules it is recommended to short/isolate external circuits accordingly for maximum safety.
4. To properly insert a module, ensure that the correct module type is inserted into the correct slot position. The ejector/insertion clips located at the top and at the bottom of each module must be in the disengaged position as the module is smoothly inserted into the slot. Once the clips have cleared the raised edge of the chassis, engage the clips simultaneously. When the clips have locked into position, the module is fully inserted.



When adding a module (versus replacing a module), check that settings have not changed. Depending on the module, settings can reset to default values.



An upgrade example is replacing the CPU module with a more recent one, such as swapping 9G/9H/9N with 9T/9U/9V/9W. A power supply module upgrade does not affect an order code.

To upgrade a module:

1. Back up settings by sending the device to the Offline Window area. Convert the settings to the new order code by right-clicking in the Offline Window area. Replace the module as outlined in the previous procedure. In the Online Window area, reset all settings to factory defaults and read the new order code from the device using **Commands > Relay Maintenance > Update Order Code**. Send the saved settings from the Offline Window area to the online device. Refresh the order code in the **Device Setup** window and set the device to "Programmed" under **Settings > Product Setup > Installation**.

## 11.13 Battery

A battery powers the real time clock on startup of the device.

When required, the battery can be replaced. The battery type is 3 V cylindrical.

The power supply module contains the battery. The power supply modules were upgraded in 2014 to SH/SL from RH/RL, but the order code when purchasing a UR with redundant power supply remained as RH/RL so that customers can continue to use the same order codes. The order code can read RH or RL, while the module inside the unit reads SH or SL. The order code for replacement redundant power supply modules was changed to SH/SL.

### 11.13.1 Replace battery

When required, the battery can be replaced. The power supply module contains the battery.



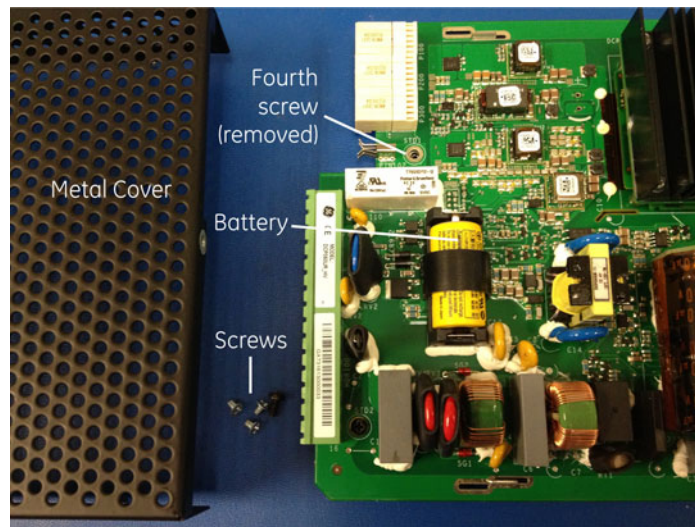
**To avoid injury, ensure that the unit has been powered off for a minimum of three minutes before replacing the battery.**

**Risk of fire if battery is replaced with incorrect type or polarity.**

To replace the battery:

1. Turn off the power to the unit.
2. Wait a minimum of three minutes to ensure that there is no power to the battery.
3. As outlined in the previous section, open the unit by sliding up the plastic latch on the right side of the front panel (basic front panel) or unscrewing the panel (enhanced front panel).
4. For the basic front panel, it needs to be removed in order to access the power supply module, which is typically in the first slot on the left side and blocked by the hinge of the front panel. To remove the front panel, unscrew the bracket on the left side of the unit.
5. Remove the power supply module by simultaneously pulling the ejector clips at the top and bottom of the module and sliding it out.
6. Unscrew all four screws (not three) that attach the metal cover to the module. The fourth screw is at the back end of the module, on the opposite side from the clips, beside the white electronics part (see figure).
7. Slide the metal cover away from the clips about 0.5 cm (1/8 inch) and remove the cover.
8. Unclip the black plastic holder that keeps the battery in place. The plastic clips into the socket at the bottom on both sides—pull the plastic away from the battery. Use a flat-head screwdriver if you cannot unclip the plastic with your fingers.
9. Replace the battery with the identical make and model. For example, do not use a rechargeable battery. Observe the + and - polarity of the battery and replace it with the same polarity as marked on the battery holder.

Figure 11-28: Battery location on power supply module



859717A1.cdr

10. Reinstall the battery holder and the metal cover, and reinsert the power supply module into the unit.
11. Power on the unit.
12. Dispose of the old battery as outlined in the next section.

### 11.13.2 Dispose of battery



#### 11.13.2.1 EN Battery disposal

This product contains a battery that cannot be disposed of as unsorted municipal waste in the European Union. See the product documentation for specific battery information. The battery is marked with this symbol, which may include lettering to indicate cadmium (Cd), lead (Pb), or mercury (Hg). For proper recycling return the battery to your supplier or to a designated collection point. For more information see: [www.recyclethis.info](http://www.recyclethis.info).

#### 11.13.2.2 CS Nakládání s bateriemi

Tento produkt obsahuje baterie, které nemohou být zneškodněny v Evropské unii jako netříděný komunální odpad. Viz dokumentace k produktu pro informace pro konkrétní baterie. Baterie je označena tímto symbolem, který může zahrnovat i uvedena písmena, kadmium (Cd), olovo (Pb), nebo rtuť (Hg). Pro správnou recyklaci baterií vraťte svémudodavateli nebo na určeném sběrném místě. Pro více informací viz: [www.recyclethis.info](http://www.recyclethis.info).

#### 11.13.2.3 DA Batteri affald

Dette produkt indeholder et batteri som ikke kan bortskaffes sammen med almindeligt husholdningsaffald i Europa. Se produktinformation for specifikke informationer om batteriet. Batteriet er forsynet med indgraveret symboler for hvad batteriet indeholder: kadmium (Cd), bly (Pb) og kviksølv (Hg). Europæiske brugere af elektrisk udstyr skal aflevere kasserede produkter til genbrug eller til leverandøren. Yderligere oplysninger findes på webstedet [www.recyclethis.info](http://www.recyclethis.info).

#### 11.13.2.4 DE Entsorgung von Batterien

Dieses Produkt beinhaltet eine Batterie, die nicht als unsortierter städtischer Abfall in der europäischen Union entsorgt werden darf. Beachten Sie die spezifischen Batterie-Informationen in der Produktdokumentation. Die Batterie ist mit diesem Symbol gekennzeichnet, welches auch Hinweise auf möglicherweise enthaltene Stoffe wie Kadmium (Cd), Blei (Pb) oder Quecksilber (Hektogramm) darstellt. Für die korrekte Wiederverwertung bringen Sie diese Batterie zu Ihrem lokalen Lieferanten zurück oder entsorgen Sie das Produkt an den gekennzeichneten Sammelstellen. Weitere Informationen hierzu finden Sie auf der folgenden Website: [www.recyclethis.info](http://www.recyclethis.info).

#### 11.13.2.5 EL Απόρριψη μπαταριών

Αυτό το προϊόν περιέχει μια μπαταρία που δεν πρέπει να απορρίπτεται σε δημόσια συστήματα απόρριψης στην Ευρωπαϊκή Κοινότητα. Δείτε την τεκμηρίωση του προϊόντος για συγκεκριμένες πληροφορίες που αφορούν τη μπαταρία. Η μπαταρία είναι φέρει σήμανση με αυτό το σύμβολο, το οποίο μπορεί να περιλαμβάνει γράμματα για να δηλώσουν το κάδμιο (Cd), τον μόλυβδο (Pb), ή τον υδράργυρο (Hg). Για την κατάλληλη ανακύκλωση επιστρέψτε την μπαταρία στον προμηθευτή σας ή σε καθορισμένο σημείο συλλογής. Για περισσότερες πληροφορίες δείτε: [www.recyclethis.info](http://www.recyclethis.info).

#### 11.13.2.6 ES Eliminación de baterías

Este producto contiene una batería que no se pueda eliminar como basura normal sin clasificar en la Unión Europea. Examine la documentación del producto para la información específica de la batería. La batería se marca con este símbolo, que puede incluir siglas para indicar el cadmio (Cd), el plomo (Pb), o el mercurio (Hg). Para el reciclaje apropiado, devuelva este producto a su distribuidor o deshágase de él en los puntos de reciclaje designados. Para más información: [www.recyclethis.info](http://www.recyclethis.info).

#### 11.13.2.7 ET Patareide kõrvaldamine

Käesolev toode sisaldab patareisid, mida Euroopa Liidus ei tohi kõrvaldada sorteerimata olmejäätmetena. Andmeid patareide kohta vaadake toote dokumentatsioonist. Patareid on mürgistatud käesoleva sümboliga, millel võib olla kaadmiumi (Cd), pliid (Pb) või elavhõbedat (Hg) tähistavad tähed. Nõuetekohaseks ringlusse võtmiseks tagastage patareid tarnijale või kindlaksmääratud vastuvõtupunkti. Lisainformatsiooni saab Internetist aadressil: [www.recyclethis.info](http://www.recyclethis.info).

#### 11.13.2.8 FI Paristoje ja akkujen hävittäminen

Tuote sisältää pariston, jota ei saa hävittää Euroopan Unionin alueella talousjätteen mukana. Tarkista tuoteselosteesta tuotteen tiedot. Paristo on merkitty tällä symbolilla ja saattaa sisältää kadmiumia (Cd), lyijyä (Pb) tai elohopeaa (Hg). Oikean kierrätystavan varmistamiseksi palauta tuote paikalliselle jälleenmyyjälle tai palauta se paristojen keräyspisteeseen. Lisätietoja sivuilla [www.recyclethis.info](http://www.recyclethis.info).

#### 11.13.2.9 FR Élimination des piles

Ce produit contient une batterie qui ne peuvent être éliminés comme déchets municipaux non triés dans l'Union européenne. Voir la documentation du produit au niveau des renseignements sur la pile. La batterie est marqué de ce symbole, qui comprennent les indications cadmium (Cd), plomb (Pb), ou mercure (Hg). Pour le recyclage, retourner la batterie à votre fournisseur ou à un point de collecte. Pour plus d'informations, voir: [www.recyclethis.info](http://www.recyclethis.info).

#### 11.13.2.10 HU Akkumulátor hulladék kezelése

Ezen termék akkumulátort tartalmaz, amely az Európai Unió belül csak a kijelölt módon és helyen dobható ki. A termékben illetve a mellékelt ismertetőn olvasható a kadmium (Cd), ólom (Pb) vagy higany (Hg) tartalomra utaló betűjelzés. A hulladék akkumulátor leadható a termék forgalmazójánál új akkumulátor vásárlásakor, vagy a kijelölt elektronikai hulladékdudvarokban. További információ a [www.recyclethis.info](http://www.recyclethis.info) oldalon.



### 11.13.2.11 IT Smaltimento batterie

Questo prodotto contiene una batteria che non può essere smaltita nei comuni contenitori per lo smaltimento rifiuti, nell'Unione Europea. Controllate la documentazione del prodotto per le informazioni specifiche sulla batteria. La batteria è contrassegnata con questo simbolo e può includere alcuni caratteri ad indicare la presenza di cadmio (Cd), piombo (Pb) oppure mercurio (Hg). Per il corretto smaltimento, potete restituirli al vostro fornitore locale, oppure rivolgervi e consegnarli presso i centri di raccolta preposti. Per maggiori informazioni vedere: [www.recyclethis.info](http://www.recyclethis.info).

### 11.13.2.12 LT Baterijų šalinimas

Šios įrangos sudėtyje yra baterijų, kurias draudžiama šalinti Europos Sąjungos viešose nerūšiuotų atliekų šalinimo sistemose. Informaciją apie baterijas galite rasti įrangos techninėje dokumentacijoje. Baterijos žymimos šiuo simboliu, papildomai gali būti nurodoma kad baterijų sudėtyje yra kadmio (Cd), švino (Pb) ar gyvsidabrio (Hg). Eksploatavimui nebetinkamas baterijas pristatykite į tam skirtas surinkimo vietas arba grąžinkite jas tiesioginiam tiekėjui, kad jos būtų tinkamai utilizuotos. Daugiau informacijos rasite šioje interneto svetainėje: [www.recyclethis.info](http://www.recyclethis.info).

### 11.13.2.13 LV Bateriju likvidēšana

Šis produkts satur bateriju vai akumulatoru, kuru nedrīkst izmest Eiropas Savienībā esošajās sadzīves atkritumu sistēmās. Sk. produkta dokumentācijā, kur ir norādīta konkrēta informācija par bateriju vai akumulatoru. Baterijas vai akumulatora marķējumā ir šis simbols, kas var ietvert burtus, kuri norāda kadmiju (Cd), svīnu (Pb) vai dzīvsudrabu (Hg). Pēc ekspluatācijas laika beigām baterijas vai akumulatori jānodod piegādātājam vai specializētā bateriju savākšanas vietā. Sīkāku informāciju var iegūt vietnē: [www.recyclethis.info](http://www.recyclethis.info).

### 11.13.2.14 NL Verwijderen van batterijen

Dit product bevat een batterij welke niet kan verwijderd worden via de gemeentelijke huisvuilscheiding in de Europese Gemeenschap. Gelieve de product documentatie te controleren voor specifieke batterij informatie. De batterijen met deze label kunnen volgende indictaies bevatten cadium (Cd), lood (Pb) of kwik (Hg). Voor correcte vorm van kringloop, geef je de producten terug aan jou locale leverancier of geef het af aan een gespecialiseerde verzamelpunt. Meer informatie vindt u op de volgende website: [www.recyclethis.info](http://www.recyclethis.info).

### 11.13.2.15 NO Retur av batteri

Dette produkt inneholder et batteri som ikke kan kastes med usortert kommunalt søppel i den Europeiske Unionen. Se produktokumentasjonen for spesifikk batteriinformatjon. Batteriet er merket med dette symbolet som kan inkludere symboler for å indikere at kadmium (Cd), bly (Pb), eller kvikksølv (Hg) forekommer. Returner batteriet til leverandøren din eller til et dedikert oppsamlingspunkt for korrekt gjenvinning. For mer informasjon se: [www.recyclethis.info](http://www.recyclethis.info).

### 11.13.2.16 PL Pozbywanie się zużytych baterii

Ten produkt zawiera baterie, które w Unii Europejskiej mogą być usuwane tylko jako posegregowane odpady komunalne. Dokładne informacje dotyczące użytych baterii znajdują się w dokumentacji produktu. Baterie oznaczone tym symbolem mogą zawierać dodatkowe oznaczenia literowe wskazujące na zawartość kadmu (Cd), ołowiu (Pb) lub rtęci (Hg). Dla zapewnienia właściwej utylizacji, należy zwrócić baterie do dostawcy albo do wyznaczonego punktu zbiórki. Więcej informacji można znaleźć na stronie internetowej [www.recyclethis.info](http://www.recyclethis.info).

### 11.13.2.17 PT Eliminação de Baterias

Este produto contém uma bateria que não pode ser considerado lixo municipal na União Europeia. Consulte a documentação do produto para obter informação específica da bateria. A bateria é identificada por meio de este símbolo, que pode incluir a rotulagem para indicar o cádmio (Cd), chumbo (Pb), ou o mercúrio (hg). Para uma reciclagem apropriada envie a bateria para o seu fornecedor ou para um ponto de recolha designado. Para mais informação veja: [www.recyclethis.info](http://www.recyclethis.info).

### 11.13.2.18 RU Утилизация батарей

Согласно европейской директиве об отходах электрического и электронного оборудования, продукты, содержащие батареи, нельзя утилизировать как обычные отходы на территории ЕС. Более подробную информацию вы найдете в документации к продукту. На этом символе могут присутствовать буквы, которые означают, что батарея содержит кадмий (Cd), свинец (Pb) или ртуть (Hg). Для надлежащей утилизации по окончании срока эксплуатации пользователь должен вернуть батареи локальному поставщику или сдать в специальный пункт приема. Подробности можно найти на веб-сайте: [www.recyclethis.info](http://www.recyclethis.info).

### 11.13.2.19 SK Zaobchádzanie s batériami

Tento produkt obsahuje batériu, s ktorou sa v Európskej únii nesmie nakladať ako s netriedeným komunálnym odpadom. Dokumentácia k produktu obsahuje špecifické informácie o batérii. Batéria je označená týmto symbolom, ktorý môže obsahovať písmená na označenie kadmia (Cd), olova (Pb), alebo ortuti (Hg). Na správnu recykláciu vráťte batériu vášmu lokálnemu dodávateľovi alebo na určené zberné miesto. Pre viac informácií pozrite: [www.recyclethis.info](http://www.recyclethis.info).

### 11.13.2.20 SL Odlaganje baterij

Ta izdelek vsebuje baterijo, ki je v Evropski uniji ni dovoljeno odstranjevati kot nesortiran komunalni odpad. Za posebne informacije o bateriji glejte dokumentacijo izdelka. Baterija je označena s tem simbolom, ki lahko vključuje napise, ki označujejo kadmij (Cd), svinec (Pb) ali živo srebro (Hg). Za ustrezno recikliranje baterijo vrnite dobavitelju ali jo odstranite na določenem zbirališču. Za več informacij obiščite spletno stran: [www.recyclethis.info](http://www.recyclethis.info).

### 11.13.2.21 SV Kassering av batteri

Denna produkt innehåller ett batteri som inte får kastas i allmänna sophanteringssystem inom den europeiska unionen. Se produktdokumentationen för specifik batteriinformation. Batteriet är märkt med denna symbol, vilket kan innebära att det innehåller kadmium (Cd), bly (Pb) eller kvicksilver (Hg). För korrekt återvinning skall batteriet returneras till leverantören eller till en därför avsedd deponering. För mer information, se: [www.recyclethis.info](http://www.recyclethis.info).

### 11.13.2.22 TR Pil Geri Dönüşümü

Bu ürün Avrupa Birliği genel atık sistemlerine atılmaması gereken pil içermektedir. Daha detaylı pil bilgisi için ürünün kataloğunu inceleyiniz. Bu sembolle işaretlenmiş piller Kadmiyum(Cd), Kurşun(Pb) ya da Civa(Hg) içerebilir. Doğru geri dönüşüm için ürünü yerel tedarikçinize geri veriniz ya da özel işaretlenmiş toplama noktalarına atınız. Daha fazla bilgi için: [www.recyclethis.info](http://www.recyclethis.info).

### 11.13.2.23 Global contacts

North America	905-294-6222
Latin America	+55 11 3614 1700
Europe, Middle East, Africa	+(34) 94 485 88 00
Asia	+86-21-2401-3208
India	+91 80 41314617

From GE Part Number 1604-0021-A1, GE Publication Number GEK-113574.

## 11.14 Clear files and data after uninstall

The unit can be decommissioned by turning off power to the unit and disconnecting the wires to it.

To clear files and settings in the UR:

1. On the UR front panel, navigate to **COMMANDS** ⇒ **RELAY MAINTENANCE** ⇒ **SERVICE COMMAND**, enter the value 20511, and press the **ENTER** key. The relay restarts and clears the UR.
2. Clear the flash memory using the **SETTINGS** ⇒ **PRODUCT SETUP** ⇒ **CLEAR RELAY RECORDS** command.

To clear files and settings on the computer:

1. Uninstall the EnerVista UR Setup software.
2. Find and delete the following UR files:
  - .URS, .CID, and .ICD settings
  - .EVT event records
  - .CFG and .DAT COMTRADE

---

## 11.15 Repairs

The battery and modules inside the case can be replaced without return of the device to the factory. The firmware and software can be upgraded without return of the device to the factory.

Fuses in the power supply module are not field-replaceable.

Files can be requested for use by technical support staff, for example the Service Report (click the icon in the software or connect a USB drive to the graphical front panel) or under **Maintenance > Retrieve File**, as outlined elsewhere in this document.

For issues not solved by troubleshooting, the process to return the device to the factory for repair is as follows:

- Contact a GE Grid Solutions Technical Support Center. Contact information is found in the first chapter.
- Obtain a Return Materials Authorization (RMA) number from the Technical Support Center.
- Verify that the RMA and Commercial Invoice received have the correct information.
- Tightly pack the unit in a box with bubble wrap, foam material, or styrofoam inserts or packaging peanuts to cushion the item(s). You may also use double boxing whereby you place the box in a larger box that contains at least 5 cm of cushioning material.
- Ship the unit by courier or freight forwarder, along with the Commercial Invoice and RMA, to the factory.

GE GRID SOLUTIONS  
650 MARKLAND STREET  
MARKHAM, ONTARIO  
CANADA L6C 0M1  
ATTN: SERVICE DEPT.  
RMA# : \_\_\_\_\_

Customers are responsible for shipping costs to the factory, regardless of whether the unit is under warranty.

- Fax a copy of the shipping information to the GE Grid Solutions service department in Canada at +1 905 927 5098.

Use the detailed return procedure outlined at

[https://www.gegridsolutions.com/multilin/support/ret\\_proc.htm](https://www.gegridsolutions.com/multilin/support/ret_proc.htm)

The current warranty and return information are outlined at

<https://www.gegridsolutions.com/multilin/warranty.htm>

---

## 11.16 Storage

Store the unit indoors in a cool, dry place. If possible, store in the original packaging. Follow the storage temperature range outlined in the Specifications.

**NOTICE**

To avoid deterioration of electrolytic capacitors, power up units that are stored in a de-energized state once per year, for one hour continuously.

---

## 11.17 Disposal

Other than the battery, there are no special requirements for disposal of the unit at the end its service life. For customers located in the European Union, dispose of the battery as outlined earlier. To prevent non-intended use of the unit, remove the modules, dismantle the unit, and recycle the metal when possible.

# G30 Generator Protection System

## Appendix A: FlexAnalog operands

This appendix outlines FlexAnalog parameters.

### A.1 FlexAnalog items

A FlexAnalog parameter is an analog parameter.

FlexAnalog items specific to your device are viewable in a web browser. Enter the IP address of the UR, access the **Device Information Menu** option, then the **FlexAnalog Parameter Listing** option. Entries displayed online depend on order code.

**Table A-1: G30 FlexAnalog data items**

Address	FlexAnalog name	Units	Description
5744	Stator Gnd Vn 3rd	Volts	Stator ground Vn third harmonic voltage
5746	Stator Gnd Vn+V0 3rd	Volts	Stator ground Vn+V0 third harmonic voltage
5748	Stator Gnd V0 3rd	Volts	Stator ground V0 third harmonic voltage
5760	Sns Dir Power 1	Watts	Sensitive directional power 1 actual value
5762	Sns Dir Power 2	Watts	Sensitive directional power 2 actual value
5792	RGF 1 Igd Mag	Amps	Restricted ground fault 1 differential ground current magnitude
5794	RGF 1 Igr Mag	Amps	Restricted ground fault 1 restricted ground current magnitude
5796	RGF 2 Igd Mag	Amps	Restricted ground fault 2 differential ground current magnitude
5798	RGF 2 Igr Mag	Amps	Restricted ground fault 2 restricted ground current magnitude
5800	RGF 3 Igd Mag	Amps	Restricted ground fault 3 differential ground current magnitude
5802	RGF 3 Igr Mag	Amps	Restricted ground fault 3 restricted ground current magnitude
5804	RGF 4 Igd Mag	Amps	Restricted ground fault 4 differential ground current magnitude
5806	RGF 4 Igr Mag	Amps	Restricted ground fault 4 restricted ground current magnitude
5824	Field RTD 1 Value	---	Field RTD 1 value
5825	Field RTD 2 Value	---	Field RTD 2 value
5826	Field RTD 3 Value	---	Field RTD 3 value
5827	Field RTD 4 Value	---	Field RTD 4 value
5828	Field RTD 5 Value	---	Field RTD 5 value
5829	Field RTD 6 Value	---	Field RTD 6 value
5830	Field RTD 7 Value	---	Field RTD 7 value
5831	Field RTD 8 Value	---	Field RTD 8 value

A

Address	FlexAnalog name	Units	Description
5832	Field TDR 1 Value	---	Field TDR 1 value
5834	Field TDR 2 Value	---	Field TDR 2 value
5836	Field TDR 3 Value	---	Field TDR 3 value
5838	Field TDR 4 Value	---	Field TDR 4 value
5840	Field TDR 5 Value	---	Field TDR 5 value
5842	Field TDR 6 Value	---	Field TDR 6 value
5844	Field TDR 7 Value	---	Field TDR 7 value
5846	Field TDR 8 Value	---	Field TDR 8 value
5856	Freq Rate 1 Value	Hz/s	Frequency rate of change 1 actual value
5860	Freq Rate 2 Value	Hz/s	Frequency rate of change 2 actual value
5864	Freq Rate 3 Value	Hz/s	Frequency rate of change 3 actual value
5868	Freq Rate 4 Value	Hz/s	Frequency rate of change 4 actual value
6144	SRC 1 Ia RMS	Amps	Source 1 phase A current RMS
6146	SRC 1 Ib RMS	Amps	Source 1 phase B current RMS
6148	SRC 1 Ic RMS	Amps	Source 1 phase C current RMS
6150	SRC 1 In RMS	Amps	Source 1 neutral current RMS
6152	SRC 1 Ia Mag	Amps	Source 1 phase A current magnitude
6154	SRC 1 Ia Angle	Degrees	Source 1 phase A current angle
6155	SRC 1 Ib Mag	Amps	Source 1 phase B current magnitude
6157	SRC 1 Ib Angle	Degrees	Source 1 phase B current angle
6158	SRC 1 Ic Mag	Amps	Source 1 phase C current magnitude
6160	SRC 1 Ic Angle	Degrees	Source 1 phase C current angle
6161	SRC 1 In Mag	Amps	Source 1 neutral current magnitude
6163	SRC 1 In Angle	Degrees	Source 1 neutral current angle
6164	SRC 1 Ig RMS	Amps	Source 1 ground current RMS
6166	SRC 1 Ig Mag	Amps	Source 1 ground current magnitude
6168	SRC 1 Ig Angle	Degrees	Source 1 ground current angle
6169	SRC 1 I <sub>0</sub> Mag	Amps	Source 1 zero-sequence current magnitude
6171	SRC 1 I <sub>0</sub> Angle	Degrees	Source 1 zero-sequence current angle
6172	SRC 1 I <sub>1</sub> Mag	Amps	Source 1 positive-sequence current magnitude
6174	SRC 1 I <sub>1</sub> Angle	Degrees	Source 1 positive-sequence current angle
6175	SRC 1 I <sub>2</sub> Mag	Amps	Source 1 negative-sequence current magnitude
6177	SRC 1 I <sub>2</sub> Angle	Degrees	Source 1 negative-sequence current angle
6178	SRC 1 Igd Mag	Amps	Source 1 differential ground current magnitude
6180	SRC 1 Igd Angle	Degrees	Source 1 differential ground current angle
6208	SRC 2 Ia RMS	Amps	Source 2 phase A current RMS
6210	SRC 2 Ib RMS	Amps	Source 2 phase B current RMS
6212	SRC 2 Ic RMS	Amps	Source 2 phase C current RMS
6214	SRC 2 In RMS	Amps	Source 2 neutral current RMS
6216	SRC 2 Ia Mag	Amps	Source 2 phase A current magnitude
6218	SRC 2 Ia Angle	Degrees	Source 2 phase A current angle
6219	SRC 2 Ib Mag	Amps	Source 2 phase B current magnitude
6221	SRC 2 Ib Angle	Degrees	Source 2 phase B current angle
6222	SRC 2 Ic Mag	Amps	Source 2 phase C current magnitude
6224	SRC 2 Ic Angle	Degrees	Source 2 phase C current angle
6225	SRC 2 In Mag	Amps	Source 2 neutral current magnitude
6227	SRC 2 In Angle	Degrees	Source 2 neutral current angle

Address	FlexAnalog name	Units	Description
6228	SRC 2 Ig RMS	Amps	Source 2 ground current RMS
6230	SRC 2 Ig Mag	Amps	Source 2 ground current magnitude
6232	SRC 2 Ig Angle	Degrees	Source 2 ground current angle
6233	SRC 2 I <sub>0</sub> Mag	Amps	Source 2 zero-sequence current magnitude
6235	SRC 2 I <sub>0</sub> Angle	Degrees	Source 2 zero-sequence current angle
6236	SRC 2 I <sub>1</sub> Mag	Amps	Source 2 positive-sequence current magnitude
6238	SRC 2 I <sub>1</sub> Angle	Degrees	Source 2 positive-sequence current angle
6239	SRC 2 I <sub>2</sub> Mag	Amps	Source 2 negative-sequence current magnitude
6241	SRC 2 I <sub>2</sub> Angle	Degrees	Source 2 negative-sequence current angle
6242	SRC 2 Igd Mag	Amps	Source 2 differential ground current magnitude
6244	SRC 2 Igd Angle	Degrees	Source 2 differential ground current angle
6272	SRC 3 Ia RMS	Amps	Source 3 phase A current RMS
6274	SRC 3 Ib RMS	Amps	Source 3 phase B current RMS
6276	SRC 3 Ic RMS	Amps	Source 3 phase C current RMS
6278	SRC 3 In RMS	Amps	Source 3 neutral current RMS
6280	SRC 3 Ia Mag	Amps	Source 3 phase A current magnitude
6282	SRC 3 Ia Angle	Degrees	Source 3 phase A current angle
6283	SRC 3 Ib Mag	Amps	Source 3 phase B current magnitude
6285	SRC 3 Ib Angle	Degrees	Source 3 phase B current angle
6286	SRC 3 Ic Mag	Amps	Source 3 phase C current magnitude
6288	SRC 3 Ic Angle	Degrees	Source 3 phase C current angle
6289	SRC 3 In Mag	Amps	Source 3 neutral current magnitude
6291	SRC 3 In Angle	Degrees	Source 3 neutral current angle
6292	SRC 3 Ig RMS	Amps	Source 3 ground current RMS
6294	SRC 3 Ig Mag	Amps	Source 3 ground current magnitude
6296	SRC 3 Ig Angle	Degrees	Source 3 ground current angle
6297	SRC 3 I <sub>0</sub> Mag	Amps	Source 3 zero-sequence current magnitude
6299	SRC 3 I <sub>0</sub> Angle	Degrees	Source 3 zero-sequence current angle
6300	SRC 3 I <sub>1</sub> Mag	Amps	Source 3 positive-sequence current magnitude
6302	SRC 3 I <sub>1</sub> Angle	Degrees	Source 3 positive-sequence current angle
6303	SRC 3 I <sub>2</sub> Mag	Amps	Source 3 negative-sequence current magnitude
6305	SRC 3 I <sub>2</sub> Angle	Degrees	Source 3 negative-sequence current angle
6306	SRC 3 Igd Mag	Amps	Source 3 differential ground current magnitude
6308	SRC 3 Igd Angle	Degrees	Source 3 differential ground current angle
6336	SRC 4 Ia RMS	Amps	Source 4 phase A current RMS
6338	SRC 4 Ib RMS	Amps	Source 4 phase B current RMS
6340	SRC 4 Ic RMS	Amps	Source 4 phase C current RMS
6342	SRC 4 In RMS	Amps	Source 4 neutral current RMS
6344	SRC 4 Ia Mag	Amps	Source 4 phase A current magnitude
6346	SRC 4 Ia Angle	Degrees	Source 4 phase A current angle
6347	SRC 4 Ib Mag	Amps	Source 4 phase B current magnitude
6349	SRC 4 Ib Angle	Degrees	Source 4 phase B current angle
6350	SRC 4 Ic Mag	Amps	Source 4 phase C current magnitude
6352	SRC 4 Ic Angle	Degrees	Source 4 phase C current angle
6353	SRC 4 In Mag	Amps	Source 4 neutral current magnitude
6355	SRC 4 In Angle	Degrees	Source 4 neutral current angle
6356	SRC 4 Ig RMS	Amps	Source 4 ground current RMS

A

Address	FlexAnalog name	Units	Description
6358	SRC 4 Ig Mag	Amps	Source 4 ground current magnitude
6360	SRC 4 Ig Angle	Degrees	Source 4 ground current angle
6361	SRC 4 I <sub>0</sub> Mag	Amps	Source 4 zero-sequence current magnitude
6363	SRC 4 I <sub>0</sub> Angle	Degrees	Source 4 zero-sequence current angle
6364	SRC 4 I <sub>1</sub> Mag	Amps	Source 4 positive-sequence current magnitude
6366	SRC 4 I <sub>1</sub> Angle	Degrees	Source 4 positive-sequence current angle
6367	SRC 4 I <sub>2</sub> Mag	Amps	Source 4 negative-sequence current magnitude
6369	SRC 4 I <sub>2</sub> Angle	Degrees	Source 4 negative-sequence current angle
6370	SRC 4 Igd Mag	Amps	Source 4 differential ground current magnitude
6372	SRC 4 Igd Angle	Degrees	Source 4 differential ground current angle
6656	SRC 1 Vag RMS	Volts	Source 1 phase AG voltage RMS
6658	SRC 1 Vbg RMS	Volts	Source 1 phase BG voltage RMS
6660	SRC 1 Vcg RMS	Volts	Source 1 phase CG voltage RMS
6662	SRC 1 Vag Mag	Volts	Source 1 phase AG voltage magnitude
6664	SRC 1 Vag Angle	Degrees	Source 1 phase AG voltage angle
6665	SRC 1 Vbg Mag	Volts	Source 1 phase BG voltage magnitude
6667	SRC 1 Vbg Angle	Degrees	Source 1 phase BG voltage angle
6668	SRC 1 Vcg Mag	Volts	Source 1 phase CG voltage magnitude
6670	SRC 1 Vcg Angle	Degrees	Source 1 phase CG voltage angle
6671	SRC 1 Vab RMS	Volts	Source 1 phase AB voltage RMS
6673	SRC 1 Vbc RMS	Volts	Source 1 phase BC voltage RMS
6675	SRC 1 Vca RMS	Volts	Source 1 phase CA voltage RMS
6677	SRC 1 Vab Mag	Volts	Source 1 phase AB voltage magnitude
6679	SRC 1 Vab Angle	Degrees	Source 1 phase AB voltage angle
6680	SRC 1 Vbc Mag	Volts	Source 1 phase BC voltage magnitude
6682	SRC 1 Vbc Angle	Degrees	Source 1 phase BC voltage angle
6683	SRC 1 Vca Mag	Volts	Source 1 phase CA voltage magnitude
6685	SRC 1 Vca Angle	Degrees	Source 1 phase CA voltage angle
6686	SRC 1 Vx RMS	Volts	Source 1 auxiliary voltage RMS
6688	SRC 1 Vx Mag	Volts	Source 1 auxiliary voltage magnitude
6690	SRC 1 Vx Angle	Degrees	Source 1 auxiliary voltage angle
6691	SRC 1 V <sub>0</sub> Mag	Volts	Source 1 zero-sequence voltage magnitude
6693	SRC 1 V <sub>0</sub> Angle	Degrees	Source 1 zero-sequence voltage angle
6694	SRC 1 V <sub>1</sub> Mag	Volts	Source 1 positive-sequence voltage magnitude
6696	SRC 1 V <sub>1</sub> Angle	Degrees	Source 1 positive-sequence voltage angle
6697	SRC 1 V <sub>2</sub> Mag	Volts	Source 1 negative-sequence voltage magnitude
6699	SRC 1 V <sub>2</sub> Angle	Degrees	Source 1 negative-sequence voltage angle
6720	SRC 2 Vag RMS	Volts	Source 2 phase AG voltage RMS
6722	SRC 2 Vbg RMS	Volts	Source 2 phase BG voltage RMS
6724	SRC 2 Vcg RMS	Volts	Source 2 phase CG voltage RMS
6726	SRC 2 Vag Mag	Volts	Source 2 phase AG voltage magnitude
6728	SRC 2 Vag Angle	Degrees	Source 2 phase AG voltage angle
6729	SRC 2 Vbg Mag	Volts	Source 2 phase BG voltage magnitude
6731	SRC 2 Vbg Angle	Degrees	Source 2 phase BG voltage angle
6732	SRC 2 Vcg Mag	Volts	Source 2 phase CG voltage magnitude
6734	SRC 2 Vcg Angle	Degrees	Source 2 phase CG voltage angle
6735	SRC 2 Vab RMS	Volts	Source 2 phase AB voltage RMS



Address	FlexAnalog name	Units	Description
6737	SRC 2 Vbc RMS	Volts	Source 2 phase BC voltage RMS
6739	SRC 2 Vca RMS	Volts	Source 2 phase CA voltage RMS
6741	SRC 2 Vab Mag	Volts	Source 2 phase AB voltage magnitude
6743	SRC 2 Vab Angle	Degrees	Source 2 phase AB voltage angle
6744	SRC 2 Vbc Mag	Volts	Source 2 phase BC voltage magnitude
6746	SRC 2 Vbc Angle	Degrees	Source 2 phase BC voltage angle
6747	SRC 2 Vca Mag	Volts	Source 2 phase CA voltage magnitude
6749	SRC 2 Vca Angle	Degrees	Source 2 phase CA voltage angle
6750	SRC 2 Vx RMS	Volts	Source 2 auxiliary voltage RMS
6752	SRC 2 Vx Mag	Volts	Source 2 auxiliary voltage magnitude
6754	SRC 2 Vx Angle	Degrees	Source 2 auxiliary voltage angle
6755	SRC 2 V_0 Mag	Volts	Source 2 zero-sequence voltage magnitude
6757	SRC 2 V_0 Angle	Degrees	Source 2 zero-sequence voltage angle
6758	SRC 2 V_1 Mag	Volts	Source 2 positive-sequence voltage magnitude
6760	SRC 2 V_1 Angle	Degrees	Source 2 positive-sequence voltage angle
6761	SRC 2 V_2 Mag	Volts	Source 2 negative-sequence voltage magnitude
6763	SRC 2 V_2 Angle	Degrees	Source 2 negative-sequence voltage angle
6784	SRC 3 Vag RMS	Volts	Source 3 phase AG voltage RMS
6786	SRC 3 Vbg RMS	Volts	Source 3 phase BG voltage RMS
6788	SRC 3 Vcg RMS	Volts	Source 3 phase CG voltage RMS
6790	SRC 3 Vag Mag	Volts	Source 3 phase AG voltage magnitude
6792	SRC 3 Vag Angle	Degrees	Source 3 phase AG voltage angle
6793	SRC 3 Vbg Mag	Volts	Source 3 phase BG voltage magnitude
6795	SRC 3 Vbg Angle	Degrees	Source 3 phase BG voltage angle
6796	SRC 3 Vcg Mag	Volts	Source 3 phase CG voltage magnitude
6798	SRC 3 Vcg Angle	Degrees	Source 3 phase CG voltage angle
6799	SRC 3 Vab RMS	Volts	Source 3 phase AB voltage RMS
6801	SRC 3 Vbc RMS	Volts	Source 3 phase BC voltage RMS
6803	SRC 3 Vca RMS	Volts	Source 3 phase CA voltage RMS
6805	SRC 3 Vab Mag	Volts	Source 3 phase AB voltage magnitude
6807	SRC 3 Vab Angle	Degrees	Source 3 phase AB voltage angle
6808	SRC 3 Vbc Mag	Volts	Source 3 phase BC voltage magnitude
6810	SRC 3 Vbc Angle	Degrees	Source 3 phase BC voltage angle
6811	SRC 3 Vca Mag	Volts	Source 3 phase CA voltage magnitude
6813	SRC 3 Vca Angle	Degrees	Source 3 phase CA voltage angle
6814	SRC 3 Vx RMS	Volts	Source 3 auxiliary voltage RMS
6816	SRC 3 Vx Mag	Volts	Source 3 auxiliary voltage magnitude
6818	SRC 3 Vx Angle	Degrees	Source 3 auxiliary voltage angle
6819	SRC 3 V_0 Mag	Volts	Source 3 zero-sequence voltage magnitude
6821	SRC 3 V_0 Angle	Degrees	Source 3 zero-sequence voltage angle
6822	SRC 3 V_1 Mag	Volts	Source 3 positive-sequence voltage magnitude
6824	SRC 3 V_1 Angle	Degrees	Source 3 positive-sequence voltage angle
6825	SRC 3 V_2 Mag	Volts	Source 3 negative-sequence voltage magnitude
6827	SRC 3 V_2 Angle	Degrees	Source 3 negative-sequence voltage angle
6848	SRC 4 Vag RMS	Volts	Source 4 phase AG voltage RMS
6850	SRC 4 Vbg RMS	Volts	Source 4 phase BG voltage RMS
6852	SRC 4 Vcg RMS	Volts	Source 4 phase CG voltage RMS

A

Address	FlexAnalog name	Units	Description
6854	SRC 4 Vag Mag	Volts	Source 4 phase AG voltage magnitude
6856	SRC 4 Vag Angle	Degrees	Source 4 phase AG voltage angle
6857	SRC 4 Vbg Mag	Volts	Source 4 phase BG voltage magnitude
6859	SRC 4 Vbg Angle	Degrees	Source 4 phase BG voltage angle
6860	SRC 4 Vcg Mag	Volts	Source 4 phase CG voltage magnitude
6862	SRC 4 Vcg Angle	Degrees	Source 4 phase CG voltage angle
6863	SRC 4 Vab RMS	Volts	Source 4 phase AB voltage RMS
6865	SRC 4 Vbc RMS	Volts	Source 4 phase BC voltage RMS
6867	SRC 4 Vca RMS	Volts	Source 4 phase CA voltage RMS
6869	SRC 4 Vab Mag	Volts	Source 4 phase AB voltage magnitude
6871	SRC 4 Vab Angle	Degrees	Source 4 phase AB voltage angle
6872	SRC 4 Vbc Mag	Volts	Source 4 phase BC voltage magnitude
6874	SRC 4 Vbc Angle	Degrees	Source 4 phase BC voltage angle
6875	SRC 4 Vca Mag	Volts	Source 4 phase CA voltage magnitude
6877	SRC 4 Vca Angle	Degrees	Source 4 phase CA voltage angle
6878	SRC 4 Vx RMS	Volts	Source 4 auxiliary voltage RMS
6880	SRC 4 Vx Mag	Volts	Source 4 auxiliary voltage magnitude
6882	SRC 4 Vx Angle	Degrees	Source 4 auxiliary voltage angle
6883	SRC 4 V_0 Mag	Volts	Source 4 zero-sequence voltage magnitude
6885	SRC 4 V_0 Angle	Degrees	Source 4 zero-sequence voltage angle
6886	SRC 4 V_1 Mag	Volts	Source 4 positive-sequence voltage magnitude
6888	SRC 4 V_1 Angle	Degrees	Source 4 positive-sequence voltage angle
6889	SRC 4 V_2 Mag	Volts	Source 4 negative-sequence voltage magnitude
6891	SRC 4 V_2 Angle	Degrees	Source 4 negative-sequence voltage angle
7168	SRC 1 P	Watts	Source 1 three-phase real power
7170	SRC 1 Pa	Watts	Source 1 phase A real power
7172	SRC 1 Pb	Watts	Source 1 phase B real power
7174	SRC 1 Pc	Watts	Source 1 phase C real power
7176	SRC 1 Q	Vars	Source 1 three-phase reactive power
7178	SRC 1 Qa	Vars	Source 1 phase A reactive power
7180	SRC 1 Qb	Vars	Source 1 phase B reactive power
7182	SRC 1 Qc	Vars	Source 1 phase C reactive power
7184	SRC 1 S	VA	Source 1 three-phase apparent power
7186	SRC 1 Sa	VA	Source 1 phase A apparent power
7188	SRC 1 Sb	VA	Source 1 phase B apparent power
7190	SRC 1 Sc	VA	Source 1 phase C apparent power
7192	SRC 1 PF	---	Source 1 three-phase power factor
7193	SRC 1 Phase A PF	---	Source 1 phase A power factor
7194	SRC 1 Phase B PF	---	Source 1 phase B power factor
7195	SRC 1 Phase C PF	---	Source 1 phase C power factor
7200	SRC 2 P	Watts	Source 2 three-phase real power
7202	SRC 2 Pa	Watts	Source 2 phase A real power
7204	SRC 2 Pb	Watts	Source 2 phase B real power
7206	SRC 2 Pc	Watts	Source 2 phase C real power
7208	SRC 2 Q	Vars	Source 2 three-phase reactive power
7210	SRC 2 Qa	Vars	Source 2 phase A reactive power
7212	SRC 2 Qb	Vars	Source 2 phase B reactive power

Address	FlexAnalog name	Units	Description
7214	SRC 2 Qc	Vars	Source 2 phase C reactive power
7216	SRC 2 S	VA	Source 2 three-phase apparent power
7218	SRC 2 Sa	VA	Source 2 phase A apparent power
7220	SRC 2 Sb	VA	Source 2 phase B apparent power
7222	SRC 2 Sc	VA	Source 2 phase C apparent power
7224	SRC 2 PF	---	Source 2 three-phase power factor
7225	SRC 2 Phase A PF	---	Source 2 phase A power factor
7226	SRC 2 Phase B PF	---	Source 2 phase B power factor
7227	SRC 2 Phase C PF	---	Source 2 phase C power factor
7232	SRC 3 P	Watts	Source 3 three-phase real power
7234	SRC 3 Pa	Watts	Source 3 phase A real power
7236	SRC 3 Pb	Watts	Source 3 phase B real power
7238	SRC 3 Pc	Watts	Source 3 phase C real power
7240	SRC 3 Q	Vars	Source 3 three-phase reactive power
7242	SRC 3 Qa	Vars	Source 3 phase A reactive power
7244	SRC 3 Qb	Vars	Source 3 phase B reactive power
7246	SRC 3 Qc	Vars	Source 3 phase C reactive power
7248	SRC 3 S	VA	Source 3 three-phase apparent power
7250	SRC 3 Sa	VA	Source 3 phase A apparent power
7252	SRC 3 Sb	VA	Source 3 phase B apparent power
7254	SRC 3 Sc	VA	Source 3 phase C apparent power
7256	SRC 3 PF	---	Source 3 three-phase power factor
7257	SRC 3 Phase A PF	---	Source 3 phase A power factor
7258	SRC 3 Phase B PF	---	Source 3 phase B power factor
7259	SRC 3 Phase C PF	---	Source 3 phase C power factor
7264	SRC 4 P	Watts	Source 4 three-phase real power
7266	SRC 4 Pa	Watts	Source 4 phase A real power
7268	SRC 4 Pb	Watts	Source 4 phase B real power
7270	SRC 4 Pc	Watts	Source 4 phase C real power
7272	SRC 4 Q	Vars	Source 4 three-phase reactive power
7274	SRC 4 Qa	Vars	Source 4 phase A reactive power
7276	SRC 4 Qb	Vars	Source 4 phase B reactive power
7278	SRC 4 Qc	Vars	Source 4 phase C reactive power
7280	SRC 4 S	VA	Source 4 three-phase apparent power
7282	SRC 4 Sa	VA	Source 4 phase A apparent power
7284	SRC 4 Sb	VA	Source 4 phase B apparent power
7286	SRC 4 Sc	VA	Source 4 phase C apparent power
7288	SRC 4 PF	---	Source 4 three-phase power factor
7289	SRC 4 Phase A PF	---	Source 4 phase A power factor
7290	SRC 4 Phase B PF	---	Source 4 phase B power factor
7291	SRC 4 Phase C PF	---	Source 4 phase C power factor
7424	SRC 1 Pos Watthour	kWh	Source 1 positive Watthour
7426	SRC 1 Neg Watthour	Wh	Source 1 negative Watthour
7428	SRC 1 Pos varh	varh	Source 1 positive varhour
7430	SRC 1 Neg varh	varh	Source 1 negative varhour
7440	SRC 2 Pos Watthour	kWh	Source 2 positive Watthour
7442	SRC 2 Neg Watthour	Wh	Source 2 negative Watthour

A

Address	FlexAnalog name	Units	Description
7444	SRC 2 Pos varh	varh	Source 2 positive varhour
7446	SRC 2 Neg varh	varh	Source 2 negative varhour
7456	SRC 3 Pos Watthour	kWh	Source 3 positive Watthour
7458	SRC 3 Neg Watthour	kWh	Source 3 negative Watthour
7460	SRC 3 Pos varh	varh	Source 3 positive varhour
7462	SRC 3 Neg varh	varh	Source 3 negative varhour
7472	SRC 4 Pos Watthour	Wh	Source 4 positive Watthour
7474	SRC 4 Neg Watthour	Wh	Source 4 negative Watthour
7476	SRC 4 Pos varh	varh	Source 4 positive varhour
7478	SRC 4 Neg varh	varh	Source 4 negative varhour
7552	SRC 1 Frequency	Hz	Source 1 frequency
7554	SRC 2 Frequency	Hz	Source 2 frequency
7556	SRC 3 Frequency	Hz	Source 3 frequency
7558	SRC 4 Frequency	Hz	Source 4 frequency
8064	SRC 1 Va THD	%	Source 1 phase A voltage total harmonic distortion (THD)
8065	SRC 1 Va Harm[2]	%	Source 1 phase A voltage second harmonic
8066	SRC 1 Va Harm[3]	%	Source 1 phase A voltage third harmonic
8067	SRC 1 Va Harm[4]	%	Source 1 phase A voltage fourth harmonic
8068	SRC 1 Va Harm[5]	%	Source 1 phase A voltage fifth harmonic
8069	SRC 1 Va Harm[6]	%	Source 1 phase A voltage sixth harmonic
8070	SRC 1 Va Harm[7]	%	Source 1 phase A voltage seventh harmonic
8071	SRC 1 Va Harm[8]	%	Source 1 phase A voltage eighth harmonic
8072	SRC 1 Va Harm[9]	%	Source 1 phase A voltage ninth harmonic
8073	SRC 1 Va Harm[10]	%	Source 1 phase A voltage tenth harmonic
8074	SRC 1 Va Harm[11]	%	Source 1 phase A voltage eleventh harmonic
8075	SRC 1 Va Harm[12]	%	Source 1 phase A voltage twelfth harmonic
8076	SRC 1 Va Harm[13]	%	Source 1 phase A voltage thirteenth harmonic
8077	SRC 1 Va Harm[14]	%	Source 1 phase A voltage fourteenth harmonic
8078	SRC 1 Va Harm[15]	%	Source 1 phase A voltage fifteenth harmonic
8079	SRC 1 Va Harm[16]	%	Source 1 phase A voltage sixteenth harmonic
8080	SRC 1 Va Harm[17]	%	Source 1 phase A voltage seventeenth harmonic
8081	SRC 1 Va Harm[18]	%	Source 1 phase A voltage eighteenth harmonic
8082	SRC 1 Va Harm[19]	%	Source 1 phase A voltage nineteenth harmonic
8083	SRC 1 Va Harm[20]	%	Source 1 phase A voltage twentieth harmonic
8084	SRC 1 Va Harm[21]	%	Source 1 phase A voltage twenty-first harmonic
8085	SRC 1 Va Harm[22]	%	Source 1 phase A voltage twenty-second harmonic
8086	SRC 1 Va Harm[23]	%	Source 1 phase A voltage twenty-third harmonic
8087	SRC 1 Va Harm[24]	%	Source 1 phase A voltage twenty-fourth harmonic
8088	SRC 1 Va Harm[25]	%	Source 1 phase A voltage twenty-fifth harmonic
8089	SRC 1 Vb THD	%	Source 1 phase B voltage total harmonic distortion (THD)
8090	SRC 1 Vb Harm[2]	%	Source 1 phase B voltage second harmonic
8091	SRC 1 Vb Harm[3]	%	Source 1 phase B voltage third harmonic
8092	SRC 1 Vb Harm[4]	%	Source 1 phase B voltage fourth harmonic
8093	SRC 1 Vb Harm[5]	%	Source 1 phase B voltage fifth harmonic
8094	SRC 1 Vb Harm[6]	%	Source 1 phase B voltage sixth harmonic
8095	SRC 1 Vb Harm[7]	%	Source 1 phase B voltage seventh harmonic
8096	SRC 1 Vb Harm[8]	%	Source 1 phase B voltage eighth harmonic

Address	FlexAnalog name	Units	Description
8097	SRC 1 Vb Harm[9]	%	Source 1 phase B voltage ninth harmonic
8098	SRC 1 Vb Harm[10]	%	Source 1 phase B voltage tenth harmonic
8099	SRC 1 Vb Harm[11]	%	Source 1 phase B voltage eleventh harmonic
8100	SRC 1 Vb Harm[12]	%	Source 1 phase B voltage twelfth harmonic
8101	SRC 1 Vb Harm[13]	%	Source 1 phase B voltage thirteenth harmonic
8102	SRC 1 Vb Harm[14]	%	Source 1 phase B voltage fourteenth harmonic
8103	SRC 1 Vb Harm[15]	%	Source 1 phase B voltage fifteenth harmonic
8104	SRC 1 Vb Harm[16]	%	Source 1 phase B voltage sixteenth harmonic
8105	SRC 1 Vb Harm[17]	%	Source 1 phase B voltage seventeenth harmonic
8106	SRC 1 Vb Harm[18]	%	Source 1 phase B voltage eighteenth harmonic
8107	SRC 1 Vb Harm[19]	%	Source 1 phase B voltage nineteenth harmonic
8108	SRC 1 Vb Harm[20]	%	Source 1 phase B voltage twentieth harmonic
8109	SRC 1 Vb Harm[21]	%	Source 1 phase B voltage twenty-first harmonic
8110	SRC 1 Vb Harm[22]	%	Source 1 phase B voltage twenty-second harmonic
8111	SRC 1 Vb Harm[23]	%	Source 1 phase B voltage twenty-third harmonic
8112	SRC 1 Vb Harm[24]	%	Source 1 phase B voltage twenty-fourth harmonic
8113	SRC 1 Vb Harm[25]	%	Source 1 phase B voltage twenty-fifth harmonic
8114	SRC 1 Vc THD	%	Source 1 phase C voltage total harmonic distortion (THD)
8115	SRC 1 Vc Harm[2]	%	Source 1 phase C voltage second harmonic
8116	SRC 1 Vc Harm[3]	%	Source 1 phase C voltage third harmonic
8117	SRC 1 Vc Harm[4]	%	Source 1 phase C voltage fourth harmonic
8118	SRC 1 Vc Harm[5]	%	Source 1 phase C voltage fifth harmonic
8119	SRC 1 Vc Harm[6]	%	Source 1 phase C voltage sixth harmonic
8120	SRC 1 Vc Harm[7]	%	Source 1 phase C voltage seventh harmonic
8121	SRC 1 Vc Harm[8]	%	Source 1 phase C voltage eighth harmonic
8122	SRC 1 Vc Harm[9]	%	Source 1 phase C voltage ninth harmonic
8123	SRC 1 Vc Harm[10]	%	Source 1 phase C voltage tenth harmonic
8124	SRC 1 Vc Harm[11]	%	Source 1 phase C voltage eleventh harmonic
8125	SRC 1 Vc Harm[12]	%	Source 1 phase C voltage twelfth harmonic
8126	SRC 1 Vc Harm[13]	%	Source 1 phase C voltage thirteenth harmonic
8127	SRC 1 Vc Harm[14]	%	Source 1 phase C voltage fourteenth harmonic
8128	SRC 1 Vc Harm[15]	%	Source 1 phase C voltage fifteenth harmonic
8129	SRC 1 Vc Harm[16]	%	Source 1 phase C voltage sixteenth harmonic
8130	SRC 1 Vc Harm[17]	%	Source 1 phase C voltage seventeenth harmonic
8131	SRC 1 Vc Harm[18]	%	Source 1 phase C voltage eighteenth harmonic
8132	SRC 1 Vc Harm[19]	%	Source 1 phase C voltage nineteenth harmonic
8133	SRC 1 Vc Harm[20]	%	Source 1 phase C voltage twentieth harmonic
8134	SRC 1 Vc Harm[21]	%	Source 1 phase C voltage twenty-first harmonic
8135	SRC 1 Vc Harm[22]	%	Source 1 phase C voltage twenty-second harmonic
8136	SRC 1 Vc Harm[23]	%	Source 1 phase C voltage twenty-third harmonic
8137	SRC 1 Vc Harm[24]	%	Source 1 phase C voltage twenty-fourth harmonic
8138	SRC 1 Vc Harm[25]	%	Source 1 phase C voltage twenty-fifth harmonic
8139	SRC 2 Va THD	%	Source 2 phase A voltage total harmonic distortion (THD)
8140	SRC 2 Va Harm[2]	%	Source 2 phase A voltage second harmonic
8141	SRC 2 Va Harm[3]	%	Source 2 phase A voltage third harmonic
8142	SRC 2 Va Harm[4]	%	Source 2 phase A voltage fourth harmonic
8143	SRC 2 Va Harm[5]	%	Source 2 phase A voltage fifth harmonic

A

Address	FlexAnalog name	Units	Description
8144	SRC 2 Va Harm[6]	%	Source 2 phase A voltage sixth harmonic
8145	SRC 2 Va Harm[7]	%	Source 2 phase A voltage seventh harmonic
8146	SRC 2 Va Harm[8]	%	Source 2 phase A voltage eighth harmonic
8147	SRC 2 Va Harm[9]	%	Source 2 phase A voltage ninth harmonic
8148	SRC 2 Va Harm[10]	%	Source 2 phase A voltage tenth harmonic
8149	SRC 2 Va Harm[11]	%	Source 2 phase A voltage eleventh harmonic
8150	SRC 2 Va Harm[12]	%	Source 2 phase A voltage twelfth harmonic
8151	SRC 2 Va Harm[13]	%	Source 2 phase A voltage thirteenth harmonic
8152	SRC 2 Va Harm[14]	%	Source 2 phase A voltage fourteenth harmonic
8153	SRC 2 Va Harm[15]	%	Source 2 phase A voltage fifteenth harmonic
8154	SRC 2 Va Harm[16]	%	Source 2 phase A voltage sixteenth harmonic
8155	SRC 2 Va Harm[17]	%	Source 2 phase A voltage seventeenth harmonic
8156	SRC 2 Va Harm[18]	%	Source 2 phase A voltage eighteenth harmonic
8157	SRC 2 Va Harm[19]	%	Source 2 phase A voltage nineteenth harmonic
8158	SRC 2 Va Harm[20]	%	Source 2 phase A voltage twentieth harmonic
8159	SRC 2 Va Harm[21]	%	Source 2 phase A voltage twenty-first harmonic
8160	SRC 2 Va Harm[22]	%	Source 2 phase A voltage twenty-second harmonic
8161	SRC 2 Va Harm[23]	%	Source 2 phase A voltage twenty-third harmonic
8162	SRC 2 Va Harm[24]	%	Source 2 phase A voltage twenty-fourth harmonic
8163	SRC 2 Va Harm[25]	%	Source 2 phase A voltage twenty-fifth harmonic
8164	SRC 2 Vb THD	%	Source 2 phase B voltage total harmonic distortion (THD)
8165	SRC 2 Vb Harm[2]	%	Source 2 phase B voltage second harmonic
8166	SRC 2 Vb Harm[3]	%	Source 2 phase B voltage third harmonic
8167	SRC 2 Vb Harm[4]	%	Source 2 phase B voltage fourth harmonic
8168	SRC 2 Vb Harm[5]	%	Source 2 phase B voltage fifth harmonic
8169	SRC 2 Vb Harm[6]	%	Source 2 phase B voltage sixth harmonic
8170	SRC 2 Vb Harm[7]	%	Source 2 phase B voltage seventh harmonic
8171	SRC 2 Vb Harm[8]	%	Source 2 phase B voltage eighth harmonic
8172	SRC 2 Vb Harm[9]	%	Source 2 phase B voltage ninth harmonic
8173	SRC 2 Vb Harm[10]	%	Source 2 phase B voltage tenth harmonic
8174	SRC 2 Vb Harm[11]	%	Source 2 phase B voltage eleventh harmonic
8175	SRC 2 Vb Harm[12]	%	Source 2 phase B voltage twelfth harmonic
8176	SRC 2 Vb Harm[13]	%	Source 2 phase B voltage thirteenth harmonic
8177	SRC 2 Vb Harm[14]	%	Source 2 phase B voltage fourteenth harmonic
8178	SRC 2 Vb Harm[15]	%	Source 2 phase B voltage fifteenth harmonic
8179	SRC 2 Vb Harm[16]	%	Source 2 phase B voltage sixteenth harmonic
8180	SRC 2 Vb Harm[17]	%	Source 2 phase B voltage seventeenth harmonic
8181	SRC 2 Vb Harm[18]	%	Source 2 phase B voltage eighteenth harmonic
8182	SRC 2 Vb Harm[19]	%	Source 2 phase B voltage nineteenth harmonic
8183	SRC 2 Vb Harm[20]	%	Source 2 phase B voltage twentieth harmonic
8184	SRC 2 Vb Harm[21]	%	Source 2 phase B voltage twenty-first harmonic
8185	SRC 2 Vb Harm[22]	%	Source 2 phase B voltage twenty-second harmonic
8186	SRC 2 Vb Harm[23]	%	Source 2 phase B voltage twenty-third harmonic
8187	SRC 2 Vb Harm[24]	%	Source 2 phase B voltage twenty-fourth harmonic
8188	SRC 2 Vb Harm[25]	%	Source 2 phase B voltage twenty-fifth harmonic
8189	SRC 2 Vc THD	%	Source 2 phase C voltage total harmonic distortion (THD)
8190	SRC 2 Vc Harm[2]	%	Source 2 phase C voltage second harmonic

Address	FlexAnalog name	Units	Description
8191	SRC 2 Vc Harm[3]	%	Source 2 phase C voltage third harmonic
8192	SRC 2 Vc Harm[4]	%	Source 2 phase C voltage fourth harmonic
8193	SRC 2 Vc Harm[5]	%	Source 2 phase C voltage fifth harmonic
8194	SRC 2 Vc Harm[6]	%	Source 2 phase C voltage sixth harmonic
8195	SRC 2 Vc Harm[7]	%	Source 2 phase C voltage seventh harmonic
8196	SRC 2 Vc Harm[8]	%	Source 2 phase C voltage eighth harmonic
8197	SRC 2 Vc Harm[9]	%	Source 2 phase C voltage ninth harmonic
8198	SRC 2 Vc Harm[10]	%	Source 2 phase C voltage tenth harmonic
8199	SRC 2 Vc Harm[11]	%	Source 2 phase C voltage eleventh harmonic
8200	SRC 2 Vc Harm[12]	%	Source 2 phase C voltage twelfth harmonic
8201	SRC 2 Vc Harm[13]	%	Source 2 phase C voltage thirteenth harmonic
8202	SRC 2 Vc Harm[14]	%	Source 2 phase C voltage fourteenth harmonic
8203	SRC 2 Vc Harm[15]	%	Source 2 phase C voltage fifteenth harmonic
8204	SRC 2 Vc Harm[16]	%	Source 2 phase C voltage sixteenth harmonic
8205	SRC 2 Vc Harm[17]	%	Source 2 phase C voltage seventeenth harmonic
8206	SRC 2 Vc Harm[18]	%	Source 2 phase C voltage eighteenth harmonic
8207	SRC 2 Vc Harm[19]	%	Source 2 phase C voltage nineteenth harmonic
8208	SRC 2 Vc Harm[20]	%	Source 2 phase C voltage twentieth harmonic
8209	SRC 2 Vc Harm[21]	%	Source 2 phase C voltage twenty-first harmonic
8210	SRC 2 Vc Harm[22]	%	Source 2 phase C voltage twenty-second harmonic
8211	SRC 2 Vc Harm[23]	%	Source 2 phase C voltage twenty-third harmonic
8212	SRC 2 Vc Harm[24]	%	Source 2 phase C voltage twenty-fourth harmonic
8213	SRC 2 Vc Harm[25]	%	Source 2 phase C voltage twenty-fifth harmonic
8214	SRC 3 Va THD	%	Source 3 phase A voltage total harmonic distortion (THD)
8215	SRC 3 Va Harm[2]	%	Source 3 phase A voltage second harmonic
8216	SRC 3 Va Harm[3]	%	Source 3 phase A voltage third harmonic
8217	SRC 3 Va Harm[4]	%	Source 3 phase A voltage fourth harmonic
8218	SRC 3 Va Harm[5]	%	Source 3 phase A voltage fifth harmonic
8219	SRC 3 Va Harm[6]	%	Source 3 phase A voltage sixth harmonic
8220	SRC 3 Va Harm[7]	%	Source 3 phase A voltage seventh harmonic
8221	SRC 3 Va Harm[8]	%	Source 3 phase A voltage eighth harmonic
8222	SRC 3 Va Harm[9]	%	Source 3 phase A voltage ninth harmonic
8223	SRC 3 Va Harm[10]	%	Source 3 phase A voltage tenth harmonic
8224	SRC 3 Va Harm[11]	%	Source 3 phase A voltage eleventh harmonic
8225	SRC 3 Va Harm[12]	%	Source 3 phase A voltage twelfth harmonic
8226	SRC 3 Va Harm[13]	%	Source 3 phase A voltage thirteenth harmonic
8227	SRC 3 Va Harm[14]	%	Source 3 phase A voltage fourteenth harmonic
8228	SRC 3 Va Harm[15]	%	Source 3 phase A voltage fifteenth harmonic
8229	SRC 3 Va Harm[16]	%	Source 3 phase A voltage sixteenth harmonic
8230	SRC 3 Va Harm[17]	%	Source 3 phase A voltage seventeenth harmonic
8231	SRC 3 Va Harm[18]	%	Source 3 phase A voltage eighteenth harmonic
8232	SRC 3 Va Harm[19]	%	Source 3 phase A voltage nineteenth harmonic
8233	SRC 3 Va Harm[20]	%	Source 3 phase A voltage twentieth harmonic
8234	SRC 3 Va Harm[21]	%	Source 3 phase A voltage twenty-first harmonic
8235	SRC 3 Va Harm[22]	%	Source 3 phase A voltage twenty-second harmonic
8236	SRC 3 Va Harm[23]	%	Source 3 phase A voltage twenty-third harmonic
8237	SRC 3 Va Harm[24]	%	Source 3 phase A voltage twenty-fourth harmonic



A

Address	FlexAnalog name	Units	Description
8238	SRC 3 Va Harm[25]	%	Source 3 phase A voltage twenty-fifth harmonic
8239	SRC 3 Vb THD	%	Source 3 phase B voltage total harmonic distortion (THD)
8240	SRC 3 Vb Harm[2]	%	Source 3 phase B voltage second harmonic
8241	SRC 3 Vb Harm[3]	%	Source 3 phase B voltage third harmonic
8242	SRC 3 Vb Harm[4]	%	Source 3 phase B voltage fourth harmonic
8243	SRC 3 Vb Harm[5]	%	Source 3 phase B voltage fifth harmonic
8244	SRC 3 Vb Harm[6]	%	Source 3 phase B voltage sixth harmonic
8245	SRC 3 Vb Harm[7]	%	Source 3 phase B voltage seventh harmonic
8246	SRC 3 Vb Harm[8]	%	Source 3 phase B voltage eighth harmonic
8247	SRC 3 Vb Harm[9]	%	Source 3 phase B voltage ninth harmonic
8248	SRC 3 Vb Harm[10]	%	Source 3 phase B voltage tenth harmonic
8249	SRC 3 Vb Harm[11]	%	Source 3 phase B voltage eleventh harmonic
8250	SRC 3 Vb Harm[12]	%	Source 3 phase B voltage twelfth harmonic
8251	SRC 3 Vb Harm[13]	%	Source 3 phase B voltage thirteenth harmonic
8252	SRC 3 Vb Harm[14]	%	Source 3 phase B voltage fourteenth harmonic
8253	SRC 3 Vb Harm[15]	%	Source 3 phase B voltage fifteenth harmonic
8254	SRC 3 Vb Harm[16]	%	Source 3 phase B voltage sixteenth harmonic
8255	SRC 3 Vb Harm[17]	%	Source 3 phase B voltage seventeenth harmonic
8256	SRC 3 Vb Harm[18]	%	Source 3 phase B voltage eighteenth harmonic
8257	SRC 3 Vb Harm[19]	%	Source 3 phase B voltage nineteenth harmonic
8258	SRC 3 Vb Harm[20]	%	Source 3 phase B voltage twentieth harmonic
8259	SRC 3 Vb Harm[21]	%	Source 3 phase B voltage twenty-first harmonic
8260	SRC 3 Vb Harm[22]	%	Source 3 phase B voltage twenty-second harmonic
8261	SRC 3 Vb Harm[23]	%	Source 3 phase B voltage twenty-third harmonic
8262	SRC 3 Vb Harm[24]	%	Source 3 phase B voltage twenty-fourth harmonic
8263	SRC 3 Vb Harm[25]	%	Source 3 phase B voltage twenty-fifth harmonic
8264	SRC 3 Vc THD	%	Source 3 phase C voltage total harmonic distortion (THD)
8265	SRC 3 Vc Harm[2]	%	Source 3 phase C voltage second harmonic
8266	SRC 3 Vc Harm[3]	%	Source 3 phase C voltage third harmonic
8267	SRC 3 Vc Harm[4]	%	Source 3 phase C voltage fourth harmonic
8268	SRC 3 Vc Harm[5]	%	Source 3 phase C voltage fifth harmonic
8269	SRC 3 Vc Harm[6]	%	Source 3 phase C voltage sixth harmonic
8270	SRC 3 Vc Harm[7]	%	Source 3 phase C voltage seventh harmonic
8271	SRC 3 Vc Harm[8]	%	Source 3 phase C voltage eighth harmonic
8272	SRC 3 Vc Harm[9]	%	Source 3 phase C voltage ninth harmonic
8273	SRC 3 Vc Harm[10]	%	Source 3 phase C voltage tenth harmonic
8274	SRC 3 Vc Harm[11]	%	Source 3 phase C voltage eleventh harmonic
8275	SRC 3 Vc Harm[12]	%	Source 3 phase C voltage twelfth harmonic
8276	SRC 3 Vc Harm[13]	%	Source 3 phase C voltage thirteenth harmonic
8277	SRC 3 Vc Harm[14]	%	Source 3 phase C voltage fourteenth harmonic
8278	SRC 3 Vc Harm[15]	%	Source 3 phase C voltage fifteenth harmonic
8279	SRC 3 Vc Harm[16]	%	Source 3 phase C voltage sixteenth harmonic
8280	SRC 3 Vc Harm[17]	%	Source 3 phase C voltage seventeenth harmonic
8281	SRC 3 Vc Harm[18]	%	Source 3 phase C voltage eighteenth harmonic
8282	SRC 3 Vc Harm[19]	%	Source 3 phase C voltage nineteenth harmonic
8283	SRC 3 Vc Harm[20]	%	Source 3 phase C voltage twentieth harmonic
8284	SRC 3 Vc Harm[21]	%	Source 3 phase C voltage twenty-first harmonic



Address	FlexAnalog name	Units	Description
8285	SRC 3 Vc Harm[22]	%	Source 3 phase C voltage twenty-second harmonic
8286	SRC 3 Vc Harm[23]	%	Source 3 phase C voltage twenty-third harmonic
8287	SRC 3 Vc Harm[24]	%	Source 3 phase C voltage twenty-fourth harmonic
8288	SRC 3 Vc Harm[25]	%	Source 3 phase C voltage twenty-fifth harmonic
8289	SRC 4 Va THD	%	Source 4 phase A voltage total harmonic distortion (THD)
8290	SRC 4 Va Harm[2]	%	Source 4 phase A voltage second harmonic
8291	SRC 4 Va Harm[3]	%	Source 4 phase A voltage third harmonic
8292	SRC 4 Va Harm[4]	%	Source 4 phase A voltage fourth harmonic
8293	SRC 4 Va Harm[5]	%	Source 4 phase A voltage fifth harmonic
8294	SRC 4 Va Harm[6]	%	Source 4 phase A voltage sixth harmonic
8295	SRC 4 Va Harm[7]	%	Source 4 phase A voltage seventh harmonic
8296	SRC 4 Va Harm[8]	%	Source 4 phase A voltage eighth harmonic
8297	SRC 4 Va Harm[9]	%	Source 4 phase A voltage ninth harmonic
8298	SRC 4 Va Harm[10]	%	Source 4 phase A voltage tenth harmonic
8299	SRC 4 Va Harm[11]	%	Source 4 phase A voltage eleventh harmonic
8300	SRC 4 Va Harm[12]	%	Source 4 phase A voltage twelfth harmonic
8301	SRC 4 Va Harm[13]	%	Source 4 phase A voltage thirteenth harmonic
8302	SRC 4 Va Harm[14]	%	Source 4 phase A voltage fourteenth harmonic
8303	SRC 4 Va Harm[15]	%	Source 4 phase A voltage fifteenth harmonic
8304	SRC 4 Va Harm[16]	%	Source 4 phase A voltage sixteenth harmonic
8305	SRC 4 Va Harm[17]	%	Source 4 phase A voltage seventeenth harmonic
8306	SRC 4 Va Harm[18]	%	Source 4 phase A voltage eighteenth harmonic
8307	SRC 4 Va Harm[19]	%	Source 4 phase A voltage nineteenth harmonic
8308	SRC 4 Va Harm[20]	%	Source 4 phase A voltage twentieth harmonic
8309	SRC 4 Va Harm[21]	%	Source 4 phase A voltage twenty-first harmonic
8310	SRC 4 Va Harm[22]	%	Source 4 phase A voltage twenty-second harmonic
8311	SRC 4 Va Harm[23]	%	Source 4 phase A voltage twenty-third harmonic
8312	SRC 4 Va Harm[24]	%	Source 4 phase A voltage twenty-fourth harmonic
8313	SRC 4 Va Harm[25]	%	Source 4 phase A voltage twenty-fifth harmonic
8314	SRC 4 Vb THD	%	Source 4 phase B voltage total harmonic distortion (THD)
8315	SRC 4 Vb Harm[2]	%	Source 4 phase B voltage second harmonic
8316	SRC 4 Vb Harm[3]	%	Source 4 phase B voltage third harmonic
8317	SRC 4 Vb Harm[4]	%	Source 4 phase B voltage fourth harmonic
8318	SRC 4 Vb Harm[5]	%	Source 4 phase B voltage fifth harmonic
8319	SRC 4 Vb Harm[6]	%	Source 4 phase B voltage sixth harmonic
8320	SRC 4 Vb Harm[7]	%	Source 4 phase B voltage seventh harmonic
8321	SRC 4 Vb Harm[8]	%	Source 4 phase B voltage eighth harmonic
8322	SRC 4 Vb Harm[9]	%	Source 4 phase B voltage ninth harmonic
8323	SRC 4 Vb Harm[10]	%	Source 4 phase B voltage tenth harmonic
8324	SRC 4 Vb Harm[11]	%	Source 4 phase B voltage eleventh harmonic
8325	SRC 4 Vb Harm[12]	%	Source 4 phase B voltage twelfth harmonic
8326	SRC 4 Vb Harm[13]	%	Source 4 phase B voltage thirteenth harmonic
8327	SRC 4 Vb Harm[14]	%	Source 4 phase B voltage fourteenth harmonic
8328	SRC 4 Vb Harm[15]	%	Source 4 phase B voltage fifteenth harmonic
8329	SRC 4 Vb Harm[16]	%	Source 4 phase B voltage sixteenth harmonic
8330	SRC 4 Vb Harm[17]	%	Source 4 phase B voltage seventeenth harmonic
8331	SRC 4 Vb Harm[18]	%	Source 4 phase B voltage eighteenth harmonic



Address	FlexAnalog name	Units	Description
8332	SRC 4 Vb Harm[19]	%	Source 4 phase B voltage nineteenth harmonic
8333	SRC 4 Vb Harm[20]	%	Source 4 phase B voltage twentieth harmonic
8334	SRC 4 Vb Harm[21]	%	Source 4 phase B voltage twenty-first harmonic
8335	SRC 4 Vb Harm[22]	%	Source 4 phase B voltage twenty-second harmonic
8336	SRC 4 Vb Harm[23]	%	Source 4 phase B voltage twenty-third harmonic
8337	SRC 4 Vb Harm[24]	%	Source 4 phase B voltage twenty-fourth harmonic
8338	SRC 4 Vb Harm[25]	%	Source 4 phase B voltage twenty-fifth harmonic
8339	SRC 4 Vc THD	%	Source 4 phase C voltage total harmonic distortion (THD)
8340	SRC 4 Vc Harm[2]	%	Source 4 phase C voltage second harmonic
8341	SRC 4 Vc Harm[3]	%	Source 4 phase C voltage third harmonic
8342	SRC 4 Vc Harm[4]	%	Source 4 phase C voltage fourth harmonic
8343	SRC 4 Vc Harm[5]	%	Source 4 phase C voltage fifth harmonic
8344	SRC 4 Vc Harm[6]	%	Source 4 phase C voltage sixth harmonic
8345	SRC 4 Vc Harm[7]	%	Source 4 phase C voltage seventh harmonic
8346	SRC 4 Vc Harm[8]	%	Source 4 phase C voltage eighth harmonic
8347	SRC 4 Vc Harm[9]	%	Source 4 phase C voltage ninth harmonic
8348	SRC 4 Vc Harm[10]	%	Source 4 phase C voltage tenth harmonic
8349	SRC 4 Vc Harm[11]	%	Source 4 phase C voltage eleventh harmonic
8350	SRC 4 Vc Harm[12]	%	Source 4 phase C voltage twelfth harmonic
8351	SRC 4 Vc Harm[13]	%	Source 4 phase C voltage thirteenth harmonic
8352	SRC 4 Vc Harm[14]	%	Source 4 phase C voltage fourteenth harmonic
8353	SRC 4 Vc Harm[15]	%	Source 4 phase C voltage fifteenth harmonic
8354	SRC 4 Vc Harm[16]	%	Source 4 phase C voltage sixteenth harmonic
8355	SRC 4 Vc Harm[17]	%	Source 4 phase C voltage seventeenth harmonic
8356	SRC 4 Vc Harm[18]	%	Source 4 phase C voltage eighteenth harmonic
8357	SRC 4 Vc Harm[19]	%	Source 4 phase C voltage nineteenth harmonic
8358	SRC 4 Vc Harm[20]	%	Source 4 phase C voltage twentieth harmonic
8359	SRC 4 Vc Harm[21]	%	Source 4 phase C voltage twenty-first harmonic
8360	SRC 4 Vc Harm[22]	%	Source 4 phase C voltage twenty-second harmonic
8361	SRC 4 Vc Harm[23]	%	Source 4 phase C voltage twenty-third harmonic
8362	SRC 4 Vc Harm[24]	%	Source 4 phase C voltage twenty-fourth harmonic
8363	SRC 4 Vc Harm[25]	%	Source 4 phase C voltage twenty-fifth harmonic
8960	Xfmr Ref Winding	---	Transformer reference winding
8961	Xfmr Iad Mag	pu	Transformer differential phase A current magnitude
8962	Xfmr Iad Angle	Degrees	Transformer differential phase A current angle
8963	Xfmr Iar Mag	pu	Transformer restraint phase A current magnitude
8964	Xfmr Iar Angle	Degrees	Transformer restraint phase A current angle
8965	Xfmr Harm2 Iad Mag	% fo	Transformer differential phase A second harmonic current magnitude
8966	Xfmr Harm2 Iad Angle	Degrees	Transformer differential phase A second harmonic current angle
8967	Xfmr Harm5 Iad Mag	% fo	Transformer differential phase A fifth harmonic current magnitude
8968	Xfmr Harm5 Iad Angle	Degrees	Transformer differential phase A fifth harmonic current angle
8969	Xfmr Ibd Mag	pu	Transformer differential phase B current magnitude
8970	Xfmr Ibd Angle	Degrees	Transformer differential phase B current angle
8971	Xfmr Ibr Mag	pu	Transformer restraint phase B current magnitude
8972	Xfmr Ibr Angle	Degrees	Transformer restraint phase B current angle
8973	Xfmr Harm2 Ibd Mag	% fo	Transformer differential phase B second harmonic current magnitude
8974	Xfmr Harm2 Ibd Angle	Degrees	Transformer differential phase B second harmonic current angle

Address	FlexAnalog name	Units	Description
8975	Xfmr Harm5 lbd Mag	% fo	Transformer differential phase B fifth harmonic current magnitude
8976	Xfmr Harm5 lbd Angle	Degrees	Transformer differential phase B fifth harmonic current angle
8977	Xfmr lcd Mag	pu	Transformer differential phase C current magnitude
8978	Xfmr lcd Angle	Degrees	Transformer differential phase C current angle
8979	Xfmr lcr Mag	pu	Transformer restraint phase C current magnitude
8980	Xfmr lcr Angle	Degrees	Transformer restraint phase C current angle
8981	Xfmr Harm2 lcd Mag	% fo	Transformer differential phase C second harmonic current magnitude
8982	Xfmr Harm2 lcd Angle	Degrees	Transformer differential phase C second harmonic current angle
8983	Xfmr Harm5 lcd Mag	% fo	Transformer differential phase C fifth harmonic current magnitude
8984	Xfmr Harm5 lcd Angle	Degrees	Transformer differential phase C fifth harmonic current angle
9008	Xfmr top-oil t° C	°C	Transformer top oil temperature
9009	Xfmr hst-spot t° C	°C	Transformer hottest spot temperature
9010	Xfmr agng fctr	pu	Transformer aging factor
9011	Xfmr daily LOL	Hours	Transformer daily loss of life
10240	SRC 1 Ia THD	%	Source 1 phase A current total harmonic distortion
10241	SRC 1 Ia Harm[2]	%	Source 1 phase A current second harmonic
10242	SRC 1 Ia Harm[3]	%	Source 1 phase A current third harmonic
10243	SRC 1 Ia Harm[4]	%	Source 1 phase A current fourth harmonic
10244	SRC 1 Ia Harm[5]	%	Source 1 phase A current fifth harmonic
10245	SRC 1 Ia Harm[6]	%	Source 1 phase A current sixth harmonic
10246	SRC 1 Ia Harm[7]	%	Source 1 phase A current seventh harmonic
10247	SRC 1 Ia Harm[8]	%	Source 1 phase A current eighth harmonic
10248	SRC 1 Ia Harm[9]	%	Source 1 phase A current ninth harmonic
10249	SRC 1 Ia Harm[10]	%	Source 1 phase A current tenth harmonic
10250	SRC 1 Ia Harm[11]	%	Source 1 phase A current eleventh harmonic
10251	SRC 1 Ia Harm[12]	%	Source 1 phase A current twelfth harmonic
10252	SRC 1 Ia Harm[13]	%	Source 1 phase A current thirteenth harmonic
10253	SRC 1 Ia Harm[14]	%	Source 1 phase A current fourteenth harmonic
10254	SRC 1 Ia Harm[15]	%	Source 1 phase A current fifteenth harmonic
10255	SRC 1 Ia Harm[16]	%	Source 1 phase A current sixteenth harmonic
10256	SRC 1 Ia Harm[17]	%	Source 1 phase A current seventeenth harmonic
10257	SRC 1 Ia Harm[18]	%	Source 1 phase A current eighteenth harmonic
10258	SRC 1 Ia Harm[19]	%	Source 1 phase A current nineteenth harmonic
10259	SRC 1 Ia Harm[20]	%	Source 1 phase A current twentieth harmonic
10260	SRC 1 Ia Harm[21]	%	Source 1 phase A current twenty-first harmonic
10261	SRC 1 Ia Harm[22]	%	Source 1 phase A current twenty-second harmonic
10262	SRC 1 Ia Harm[23]	%	Source 1 phase A current twenty-third harmonic
10263	SRC 1 Ia Harm[24]	%	Source 1 phase A current twenty-fourth harmonic
10264	SRC 1 Ia Harm[25]	%	Source 1 phase A current twenty-fifth harmonic
10273	SRC 1 Ib THD	%	Source 1 phase B current total harmonic distortion
10274	SRC 1 Ib Harm[2]	%	Source 1 phase B current second harmonic
10275	SRC 1 Ib Harm[3]	%	Source 1 phase B current third harmonic
10276	SRC 1 Ib Harm[4]	%	Source 1 phase B current fourth harmonic
10277	SRC 1 Ib Harm[5]	%	Source 1 phase B current fifth harmonic
10278	SRC 1 Ib Harm[6]	%	Source 1 phase B current sixth harmonic
10279	SRC 1 Ib Harm[7]	%	Source 1 phase B current seventh harmonic
10280	SRC 1 Ib Harm[8]	%	Source 1 phase B current eighth harmonic

A

Address	FlexAnalog name	Units	Description
10281	SRC 1 Ib Harm[9]	%	Source 1 phase B current ninth harmonic
10282	SRC 1 Ib Harm[10]	%	Source 1 phase B current tenth harmonic
10283	SRC 1 Ib Harm[11]	%	Source 1 phase B current eleventh harmonic
10284	SRC 1 Ib Harm[12]	%	Source 1 phase B current twelfth harmonic
10285	SRC 1 Ib Harm[13]	%	Source 1 phase B current thirteenth harmonic
10286	SRC 1 Ib Harm[14]	%	Source 1 phase B current fourteenth harmonic
10287	SRC 1 Ib Harm[15]	%	Source 1 phase B current fifteenth harmonic
10288	SRC 1 Ib Harm[16]	%	Source 1 phase B current sixteenth harmonic
10289	SRC 1 Ib Harm[17]	%	Source 1 phase B current seventeenth harmonic
10290	SRC 1 Ib Harm[18]	%	Source 1 phase B current eighteenth harmonic
10291	SRC 1 Ib Harm[19]	%	Source 1 phase B current nineteenth harmonic
10292	SRC 1 Ib Harm[20]	%	Source 1 phase B current twentieth harmonic
10293	SRC 1 Ib Harm[21]	%	Source 1 phase B current twenty-first harmonic
10294	SRC 1 Ib Harm[22]	%	Source 1 phase B current twenty-second harmonic
10295	SRC 1 Ib Harm[23]	%	Source 1 phase B current twenty-third harmonic
10296	SRC 1 Ib Harm[24]	%	Source 1 phase B current twenty-fourth harmonic
10297	SRC 1 Ib Harm[25]	%	Source 1 phase B current twenty-fifth harmonic
10306	SRC 1 Ic THD	%	Source 1 phase C current total harmonic distortion
10307	SRC 1 Ic Harm[2]	%	Source 1 phase C current second harmonic
10308	SRC 1 Ic Harm[3]	%	Source 1 phase C current third harmonic
10309	SRC 1 Ic Harm[4]	%	Source 1 phase C current fourth harmonic
10310	SRC 1 Ic Harm[5]	%	Source 1 phase C current fifth harmonic
10311	SRC 1 Ic Harm[6]	%	Source 1 phase C current sixth harmonic
10312	SRC 1 Ic Harm[7]	%	Source 1 phase C current seventh harmonic
10313	SRC 1 Ic Harm[8]	%	Source 1 phase C current eighth harmonic
10314	SRC 1 Ic Harm[9]	%	Source 1 phase C current ninth harmonic
10315	SRC 1 Ic Harm[10]	%	Source 1 phase C current tenth harmonic
10316	SRC 1 Ic Harm[11]	%	Source 1 phase C current eleventh harmonic
10317	SRC 1 Ic Harm[12]	%	Source 1 phase C current twelfth harmonic
10318	SRC 1 Ic Harm[13]	%	Source 1 phase C current thirteenth harmonic
10319	SRC 1 Ic Harm[14]	%	Source 1 phase C current fourteenth harmonic
10320	SRC 1 Ic Harm[15]	%	Source 1 phase C current fifteenth harmonic
10321	SRC 1 Ic Harm[16]	%	Source 1 phase C current sixteenth harmonic
10322	SRC 1 Ic Harm[17]	%	Source 1 phase C current seventeenth harmonic
10323	SRC 1 Ic Harm[18]	%	Source 1 phase C current eighteenth harmonic
10324	SRC 1 Ic Harm[19]	%	Source 1 phase C current nineteenth harmonic
10325	SRC 1 Ic Harm[20]	%	Source 1 phase C current twentieth harmonic
10326	SRC 1 Ic Harm[21]	%	Source 1 phase C current twenty-first harmonic
10327	SRC 1 Ic Harm[22]	%	Source 1 phase C current twenty-second harmonic
10328	SRC 1 Ic Harm[23]	%	Source 1 phase C current twenty-third harmonic
10329	SRC 1 Ic Harm[24]	%	Source 1 phase C current twenty-fourth harmonic
10330	SRC 1 Ic Harm[25]	%	Source 1 phase C current twenty-fifth harmonic
10339	SRC 2 Ia THD	%	Source 2 phase A current total harmonic distortion
10340	SRC 2 Ia Harm[2]	%	Source 2 phase A current second harmonic
10341	SRC 2 Ia Harm[3]	%	Source 2 phase A current third harmonic
10342	SRC 2 Ia Harm[4]	%	Source 2 phase A current fourth harmonic
10343	SRC 2 Ia Harm[5]	%	Source 2 phase A current fifth harmonic

Address	FlexAnalog name	Units	Description
10344	SRC 2 Ia Harm[6]	%	Source 2 phase A current sixth harmonic
10345	SRC 2 Ia Harm[7]	%	Source 2 phase A current seventh harmonic
10346	SRC 2 Ia Harm[8]	%	Source 2 phase A current eighth harmonic
10347	SRC 2 Ia Harm[9]	%	Source 2 phase A current ninth harmonic
10348	SRC 2 Ia Harm[10]	%	Source 2 phase A current tenth harmonic
10349	SRC 2 Ia Harm[11]	%	Source 2 phase A current eleventh harmonic
10350	SRC 2 Ia Harm[12]	%	Source 2 phase A current twelfth harmonic
10351	SRC 2 Ia Harm[13]	%	Source 2 phase A current thirteenth harmonic
10352	SRC 2 Ia Harm[14]	%	Source 2 phase A current fourteenth harmonic
10353	SRC 2 Ia Harm[15]	%	Source 2 phase A current fifteenth harmonic
10354	SRC 2 Ia Harm[16]	%	Source 2 phase A current sixteenth harmonic
10355	SRC 2 Ia Harm[17]	%	Source 2 phase A current seventeenth harmonic
10356	SRC 2 Ia Harm[18]	%	Source 2 phase A current eighteenth harmonic
10357	SRC 2 Ia Harm[19]	%	Source 2 phase A current nineteenth harmonic
10358	SRC 2 Ia Harm[20]	%	Source 2 phase A current twentieth harmonic
10359	SRC 2 Ia Harm[21]	%	Source 2 phase A current twenty-first harmonic
10360	SRC 2 Ia Harm[22]	%	Source 2 phase A current twenty-second harmonic
10361	SRC 2 Ia Harm[23]	%	Source 2 phase A current twenty-third harmonic
10362	SRC 2 Ia Harm[24]	%	Source 2 phase A current twenty-fourth harmonic
10363	SRC 2 Ia Harm[25]	%	Source 2 phase A current twenty-fifth harmonic
10372	SRC 2 Ib THD	%	Source 2 phase B current total harmonic distortion
10373	SRC 2 Ib Harm[2]	%	Source 2 phase B current second harmonic
10374	SRC 2 Ib Harm[3]	%	Source 2 phase B current third harmonic
10375	SRC 2 Ib Harm[4]	%	Source 2 phase B current fourth harmonic
10376	SRC 2 Ib Harm[5]	%	Source 2 phase B current fifth harmonic
10377	SRC 2 Ib Harm[6]	%	Source 2 phase B current sixth harmonic
10378	SRC 2 Ib Harm[7]	%	Source 2 phase B current seventh harmonic
10379	SRC 2 Ib Harm[8]	%	Source 2 phase B current eighth harmonic
10380	SRC 2 Ib Harm[9]	%	Source 2 phase B current ninth harmonic
10381	SRC 2 Ib Harm[10]	%	Source 2 phase B current tenth harmonic
10382	SRC 2 Ib Harm[11]	%	Source 2 phase B current eleventh harmonic
10383	SRC 2 Ib Harm[12]	%	Source 2 phase B current twelfth harmonic
10384	SRC 2 Ib Harm[13]	%	Source 2 phase B current thirteenth harmonic
10385	SRC 2 Ib Harm[14]	%	Source 2 phase B current fourteenth harmonic
10386	SRC 2 Ib Harm[15]	%	Source 2 phase B current fifteenth harmonic
10387	SRC 2 Ib Harm[16]	%	Source 2 phase B current sixteenth harmonic
10388	SRC 2 Ib Harm[17]	%	Source 2 phase B current seventeenth harmonic
10389	SRC 2 Ib Harm[18]	%	Source 2 phase B current eighteenth harmonic
10390	SRC 2 Ib Harm[19]	%	Source 2 phase B current nineteenth harmonic
10391	SRC 2 Ib Harm[20]	%	Source 2 phase B current twentieth harmonic
10392	SRC 2 Ib Harm[21]	%	Source 2 phase B current twenty-first harmonic
10393	SRC 2 Ib Harm[22]	%	Source 2 phase B current twenty-second harmonic
10394	SRC 2 Ib Harm[23]	%	Source 2 phase B current twenty-third harmonic
10395	SRC 2 Ib Harm[24]	%	Source 2 phase B current twenty-fourth harmonic
10396	SRC 2 Ib Harm[25]	%	Source 2 phase B current twenty-fifth harmonic
10405	SRC 2 Ic THD	%	Source 2 phase C current total harmonic distortion
10406	SRC 2 Ic Harm[2]	%	Source 2 phase C current second harmonic

A

Address	FlexAnalog name	Units	Description
10407	SRC 2 Ic Harm[3]	%	Source 2 phase C current third harmonic
10408	SRC 2 Ic Harm[4]	%	Source 2 phase C current fourth harmonic
10409	SRC 2 Ic Harm[5]	%	Source 2 phase C current fifth harmonic
10410	SRC 2 Ic Harm[6]	%	Source 2 phase C current sixth harmonic
10411	SRC 2 Ic Harm[7]	%	Source 2 phase C current seventh harmonic
10412	SRC 2 Ic Harm[8]	%	Source 2 phase C current eighth harmonic
10413	SRC 2 Ic Harm[9]	%	Source 2 phase C current ninth harmonic
10414	SRC 2 Ic Harm[10]	%	Source 2 phase C current tenth harmonic
10415	SRC 2 Ic Harm[11]	%	Source 2 phase C current eleventh harmonic
10416	SRC 2 Ic Harm[12]	%	Source 2 phase C current twelfth harmonic
10417	SRC 2 Ic Harm[13]	%	Source 2 phase C current thirteenth harmonic
10418	SRC 2 Ic Harm[14]	%	Source 2 phase C current fourteenth harmonic
10419	SRC 2 Ic Harm[15]	%	Source 2 phase C current fifteenth harmonic
10420	SRC 2 Ic Harm[16]	%	Source 2 phase C current sixteenth harmonic
10421	SRC 2 Ic Harm[17]	%	Source 2 phase C current seventeenth harmonic
10422	SRC 2 Ic Harm[18]	%	Source 2 phase C current eighteenth harmonic
10423	SRC 2 Ic Harm[19]	%	Source 2 phase C current nineteenth harmonic
10424	SRC 2 Ic Harm[20]	%	Source 2 phase C current twentieth harmonic
10425	SRC 2 Ic Harm[21]	%	Source 2 phase C current twenty-first harmonic
10426	SRC 2 Ic Harm[22]	%	Source 2 phase C current twenty-second harmonic
10427	SRC 2 Ic Harm[23]	%	Source 2 phase C current twenty-third harmonic
10428	SRC 2 Ic Harm[24]	%	Source 2 phase C current twenty-fourth harmonic
10429	SRC 2 Ic Harm[25]	%	Source 2 phase C current twenty-fifth harmonic
10438	SRC 3 Ia THD	%	Source 3 phase A current total harmonic distortion
10439	SRC 3 Ia Harm[2]	%	Source 3 phase A current second harmonic
10440	SRC 3 Ia Harm[3]	%	Source 3 phase A current third harmonic
10441	SRC 3 Ia Harm[4]	%	Source 3 phase A current fourth harmonic
10442	SRC 3 Ia Harm[5]	%	Source 3 phase A current fifth harmonic
10443	SRC 3 Ia Harm[6]	%	Source 3 phase A current sixth harmonic
10444	SRC 3 Ia Harm[7]	%	Source 3 phase A current seventh harmonic
10445	SRC 3 Ia Harm[8]	%	Source 3 phase A current eighth harmonic
10446	SRC 3 Ia Harm[9]	%	Source 3 phase A current ninth harmonic
10447	SRC 3 Ia Harm[10]	%	Source 3 phase A current tenth harmonic
10448	SRC 3 Ia Harm[11]	%	Source 3 phase A current eleventh harmonic
10449	SRC 3 Ia Harm[12]	%	Source 3 phase A current twelfth harmonic
10450	SRC 3 Ia Harm[13]	%	Source 3 phase A current thirteenth harmonic
10451	SRC 3 Ia Harm[14]	%	Source 3 phase A current fourteenth harmonic
10452	SRC 3 Ia Harm[15]	%	Source 3 phase A current fifteenth harmonic
10453	SRC 3 Ia Harm[16]	%	Source 3 phase A current sixteenth harmonic
10454	SRC 3 Ia Harm[17]	%	Source 3 phase A current seventeenth harmonic
10455	SRC 3 Ia Harm[18]	%	Source 3 phase A current eighteenth harmonic
10456	SRC 3 Ia Harm[19]	%	Source 3 phase A current nineteenth harmonic
10457	SRC 3 Ia Harm[20]	%	Source 3 phase A current twentieth harmonic
10458	SRC 3 Ia Harm[21]	%	Source 3 phase A current twenty-first harmonic
10459	SRC 3 Ia Harm[22]	%	Source 3 phase A current twenty-second harmonic
10460	SRC 3 Ia Harm[23]	%	Source 3 phase A current twenty-third harmonic
10461	SRC 3 Ia Harm[24]	%	Source 3 phase A current twenty-fourth harmonic

Address	FlexAnalog name	Units	Description
10462	SRC 3 Ia Harm[25]	%	Source 3 phase A current twenty-fifth harmonic
10471	SRC 3 Ib THD	%	Source 3 phase B current total harmonic distortion
10472	SRC 3 Ib Harm[2]	%	Source 3 phase B current second harmonic
10473	SRC 3 Ib Harm[3]	%	Source 3 phase B current third harmonic
10474	SRC 3 Ib Harm[4]	%	Source 3 phase B current fourth harmonic
10475	SRC 3 Ib Harm[5]	%	Source 3 phase B current fifth harmonic
10476	SRC 3 Ib Harm[6]	%	Source 3 phase B current sixth harmonic
10477	SRC 3 Ib Harm[7]	%	Source 3 phase B current seventh harmonic
10478	SRC 3 Ib Harm[8]	%	Source 3 phase B current eighth harmonic
10479	SRC 3 Ib Harm[9]	%	Source 3 phase B current ninth harmonic
10480	SRC 3 Ib Harm[10]	%	Source 3 phase B current tenth harmonic
10481	SRC 3 Ib Harm[11]	%	Source 3 phase B current eleventh harmonic
10482	SRC 3 Ib Harm[12]	%	Source 3 phase B current twelfth harmonic
10483	SRC 3 Ib Harm[13]	%	Source 3 phase B current thirteenth harmonic
10484	SRC 3 Ib Harm[14]	%	Source 3 phase B current fourteenth harmonic
10485	SRC 3 Ib Harm[15]	%	Source 3 phase B current fifteenth harmonic
10486	SRC 3 Ib Harm[16]	%	Source 3 phase B current sixteenth harmonic
10487	SRC 3 Ib Harm[17]	%	Source 3 phase B current seventeenth harmonic
10488	SRC 3 Ib Harm[18]	%	Source 3 phase B current eighteenth harmonic
10489	SRC 3 Ib Harm[19]	%	Source 3 phase B current nineteenth harmonic
10490	SRC 3 Ib Harm[20]	%	Source 3 phase B current twentieth harmonic
10491	SRC 3 Ib Harm[21]	%	Source 3 phase B current twenty-first harmonic
10492	SRC 3 Ib Harm[22]	%	Source 3 phase B current twenty-second harmonic
10493	SRC 3 Ib Harm[23]	%	Source 3 phase B current twenty-third harmonic
10494	SRC 3 Ib Harm[24]	%	Source 3 phase B current twenty-fourth harmonic
10495	SRC 3 Ib Harm[25]	%	Source 3 phase B current twenty-fifth harmonic
10504	SRC 3 Ic THD	%	Source 3 phase C current total harmonic distortion
10505	SRC 3 Ic Harm[2]	%	Source 3 phase C current second harmonic
10506	SRC 3 Ic Harm[3]	%	Source 3 phase C current third harmonic
10507	SRC 3 Ic Harm[4]	%	Source 3 phase C current fourth harmonic
10508	SRC 3 Ic Harm[5]	%	Source 3 phase C current fifth harmonic
10509	SRC 3 Ic Harm[6]	%	Source 3 phase C current sixth harmonic
10510	SRC 3 Ic Harm[7]	%	Source 3 phase C current seventh harmonic
10511	SRC 3 Ic Harm[8]	%	Source 3 phase C current eighth harmonic
10512	SRC 3 Ic Harm[9]	%	Source 3 phase C current ninth harmonic
10513	SRC 3 Ic Harm[10]	%	Source 3 phase C current tenth harmonic
10514	SRC 3 Ic Harm[11]	%	Source 3 phase C current eleventh harmonic
10515	SRC 3 Ic Harm[12]	%	Source 3 phase C current twelfth harmonic
10516	SRC 3 Ic Harm[13]	%	Source 3 phase C current thirteenth harmonic
10517	SRC 3 Ic Harm[14]	%	Source 3 phase C current fourteenth harmonic
10518	SRC 3 Ic Harm[15]	%	Source 3 phase C current fifteenth harmonic
10519	SRC 3 Ic Harm[16]	%	Source 3 phase C current sixteenth harmonic
10520	SRC 3 Ic Harm[17]	%	Source 3 phase C current seventeenth harmonic
10521	SRC 3 Ic Harm[18]	%	Source 3 phase C current eighteenth harmonic
10522	SRC 3 Ic Harm[19]	%	Source 3 phase C current nineteenth harmonic
10523	SRC 3 Ic Harm[20]	%	Source 3 phase C current twentieth harmonic
10524	SRC 3 Ic Harm[21]	%	Source 3 phase C current twenty-first harmonic



A

Address	FlexAnalog name	Units	Description
10525	SRC 3 Ic Harm[22]	%	Source 3 phase C current twenty-second harmonic
10526	SRC 3 Ic Harm[23]	%	Source 3 phase C current twenty-third harmonic
10527	SRC 3 Ic Harm[24]	%	Source 3 phase C current twenty-fourth harmonic
10528	SRC 3 Ic Harm[25]	%	Source 3 phase C current twenty-fifth harmonic
10537	SRC 4 Ia THD	%	Source 4 phase A current total harmonic distortion
10538	SRC 4 Ia Harm[2]	%	Source 4 phase A current second harmonic
10539	SRC 4 Ia Harm[3]	%	Source 4 phase A current third harmonic
10540	SRC 4 Ia Harm[4]	%	Source 4 phase A current fourth harmonic
10541	SRC 4 Ia Harm[5]	%	Source 4 phase A current fifth harmonic
10542	SRC 4 Ia Harm[6]	%	Source 4 phase A current sixth harmonic
10543	SRC 4 Ia Harm[7]	%	Source 4 phase A current seventh harmonic
10544	SRC 4 Ia Harm[8]	%	Source 4 phase A current eighth harmonic
10545	SRC 4 Ia Harm[9]	%	Source 4 phase A current ninth harmonic
10546	SRC 4 Ia Harm[10]	%	Source 4 phase A current tenth harmonic
10547	SRC 4 Ia Harm[11]	%	Source 4 phase A current eleventh harmonic
10548	SRC 4 Ia Harm[12]	%	Source 4 phase A current twelfth harmonic
10549	SRC 4 Ia Harm[13]	%	Source 4 phase A current thirteenth harmonic
10550	SRC 4 Ia Harm[14]	%	Source 4 phase A current fourteenth harmonic
10551	SRC 4 Ia Harm[15]	%	Source 4 phase A current fifteenth harmonic
10552	SRC 4 Ia Harm[16]	%	Source 4 phase A current sixteenth harmonic
10553	SRC 4 Ia Harm[17]	%	Source 4 phase A current seventeenth harmonic
10554	SRC 4 Ia Harm[18]	%	Source 4 phase A current eighteenth harmonic
10555	SRC 4 Ia Harm[19]	%	Source 4 phase A current nineteenth harmonic
10556	SRC 4 Ia Harm[20]	%	Source 4 phase A current twentieth harmonic
10557	SRC 4 Ia Harm[21]	%	Source 4 phase A current twenty-first harmonic
10558	SRC 4 Ia Harm[22]	%	Source 4 phase A current twenty-second harmonic
10559	SRC 4 Ia Harm[23]	%	Source 4 phase A current twenty-third harmonic
10560	SRC 4 Ia Harm[24]	%	Source 4 phase A current twenty-fourth harmonic
10561	SRC 4 Ia Harm[25]	%	Source 4 phase A current twenty-fifth harmonic
10570	SRC 4 Ib THD	%	Source 4 phase B current total harmonic distortion
10571	SRC 4 Ib Harm[2]	%	Source 4 phase B current second harmonic
10572	SRC 4 Ib Harm[3]	%	Source 4 phase B current third harmonic
10573	SRC 4 Ib Harm[4]	%	Source 4 phase B current fourth harmonic
10574	SRC 4 Ib Harm[5]	%	Source 4 phase B current fifth harmonic
10575	SRC 4 Ib Harm[6]	%	Source 4 phase B current sixth harmonic
10576	SRC 4 Ib Harm[7]	%	Source 4 phase B current seventh harmonic
10577	SRC 4 Ib Harm[8]	%	Source 4 phase B current eighth harmonic
10578	SRC 4 Ib Harm[9]	%	Source 4 phase B current ninth harmonic
10579	SRC 4 Ib Harm[10]	%	Source 4 phase B current tenth harmonic
10580	SRC 4 Ib Harm[11]	%	Source 4 phase B current eleventh harmonic
10581	SRC 4 Ib Harm[12]	%	Source 4 phase B current twelfth harmonic
10582	SRC 4 Ib Harm[13]	%	Source 4 phase B current thirteenth harmonic
10583	SRC 4 Ib Harm[14]	%	Source 4 phase B current fourteenth harmonic
10584	SRC 4 Ib Harm[15]	%	Source 4 phase B current fifteenth harmonic
10585	SRC 4 Ib Harm[16]	%	Source 4 phase B current sixteenth harmonic
10586	SRC 4 Ib Harm[17]	%	Source 4 phase B current seventeenth harmonic
10587	SRC 4 Ib Harm[18]	%	Source 4 phase B current eighteenth harmonic



Address	FlexAnalog name	Units	Description
10588	SRC 4 Ib Harm[19]	%	Source 4 phase B current nineteenth harmonic
10589	SRC 4 Ib Harm[20]	%	Source 4 phase B current twentieth harmonic
10590	SRC 4 Ib Harm[21]	%	Source 4 phase B current twenty-first harmonic
10591	SRC 4 Ib Harm[22]	%	Source 4 phase B current twenty-second harmonic
10592	SRC 4 Ib Harm[23]	%	Source 4 phase B current twenty-third harmonic
10593	SRC 4 Ib Harm[24]	%	Source 4 phase B current twenty-fourth harmonic
10594	SRC 4 Ib Harm[25]	%	Source 4 phase B current twenty-fifth harmonic
10603	SRC 4 Ic THD	%	Source 4 phase C current total harmonic distortion
10604	SRC 4 Ic Harm[2]	%	Source 4 phase C current second harmonic
10605	SRC 4 Ic Harm[3]	%	Source 4 phase C current third harmonic
10606	SRC 4 Ic Harm[4]	%	Source 4 phase C current fourth harmonic
10607	SRC 4 Ic Harm[5]	%	Source 4 phase C current fifth harmonic
10608	SRC 4 Ic Harm[6]	%	Source 4 phase C current sixth harmonic
10609	SRC 4 Ic Harm[7]	%	Source 4 phase C current seventh harmonic
10610	SRC 4 Ic Harm[8]	%	Source 4 phase C current eighth harmonic
10611	SRC 4 Ic Harm[9]	%	Source 4 phase C current ninth harmonic
10612	SRC 4 Ic Harm[10]	%	Source 4 phase C current tenth harmonic
10613	SRC 4 Ic Harm[11]	%	Source 4 phase C current eleventh harmonic
10614	SRC 4 Ic Harm[12]	%	Source 4 phase C current twelfth harmonic
10615	SRC 4 Ic Harm[13]	%	Source 4 phase C current thirteenth harmonic
10616	SRC 4 Ic Harm[14]	%	Source 4 phase C current fourteenth harmonic
10617	SRC 4 Ic Harm[15]	%	Source 4 phase C current fifteenth harmonic
10618	SRC 4 Ic Harm[16]	%	Source 4 phase C current sixteenth harmonic
10619	SRC 4 Ic Harm[17]	%	Source 4 phase C current seventeenth harmonic
10620	SRC 4 Ic Harm[18]	%	Source 4 phase C current eighteenth harmonic
10621	SRC 4 Ic Harm[19]	%	Source 4 phase C current nineteenth harmonic
10622	SRC 4 Ic Harm[20]	%	Source 4 phase C current twentieth harmonic
10623	SRC 4 Ic Harm[21]	%	Source 4 phase C current twenty-first harmonic
10624	SRC 4 Ic Harm[22]	%	Source 4 phase C current twenty-second harmonic
10625	SRC 4 Ic Harm[23]	%	Source 4 phase C current twenty-third harmonic
10626	SRC 4 Ic Harm[24]	%	Source 4 phase C current twenty-fourth harmonic
10627	SRC 4 Ic Harm[25]	%	Source 4 phase C current twenty-fifth harmonic
10848	Synchchk 1 Delta V	Volts	Synchrocheck 1 delta voltage
10850	Synchchk 1 Delta Phs	Degrees	Synchrocheck 1 delta phase
10851	Synchchk 1 SSCP DPh	Degrees	Synchrocheck 1 synchsscope
10852	Synchchk 1 Delta F	Hz	Synchrocheck 1 delta frequency
10853	Synchchk 1 V1 Mag	Volts	Synchrocheck 1 V1 mag
10855	Synchchk 1 V1 Ang	Degrees	Synchrocheck 1 V1 angle
10856	Synchchk 1 V2 Mag	Volts	Synchrocheck 1 V2 mag
10858	Synchchk 1 V2 Ang	Degrees	Synchrocheck 1 V2 angle
10859	Synchchk 1 V2' Mag	Volts	Synchrocheck 1 V2'_mag
10861	Synchchk 1 V2' Ang	Degrees	Synchrocheck 1 V2'_angle
10862	Synchchk 1 Delta' Phs	Degrees	Synchrocheck 1 delta'_phase
10863	Synchchk 1 SSCP DPh'	Degrees	Synchrocheck 1'_synchsscope
10864	Synchchk 2 Delta V	Volts	Synchrocheck 2 delta voltage
10866	Synchchk 2 Delta Phs	Degrees	Synchrocheck 2 delta phase
10867	Synchchk 2 SSCP DPh	Degrees	Synchrocheck 2 synchsscope



Address	FlexAnalog name	Units	Description
10868	Synchchk 2 Delta F	Hz	Synchrocheck 2 delta frequency
10869	Synchchk 2 V1 Mag	Volts	Synchrocheck 2 V1 mag
10871	Synchchk 2 V1 Ang	Degrees	Synchrocheck 2 V1 angle
10872	Synchchk 2 V2 Mag	Volts	Synchrocheck 2 V2 mag
10874	Synchchk 2 V2 Ang	Degrees	Synchrocheck 2 V2 angle
10875	Synchchk 2 V2' Mag	Volts	Synchrocheck 2 V2_mag
10877	Synchchk 2 V2' Ang	Degrees	Synchrocheck 2 V2_angle
10878	Synchchk 2 Delta' Phs	Degrees	Synchrocheck 2 delta_phase
10879	Synchchk 2 SSCP DPh'	Degrees	Synchrocheck 2 _synchscope
10880	Synchchk 3 Delta V	Volts	Synchrocheck 3 delta voltage
10882	Synchchk 3 Delta Phs	Degrees	Synchrocheck 3 delta phase
10883	Synchchk 3 SSCP DPh	Degrees	Synchrocheck 3 synchscope
10884	Synchchk 3 Delta F	Volts	Synchrocheck 3 delta frequency
10885	Synchchk 3 V1 Mag	Volts	Synchrocheck 3 V1 mag
10887	Synchchk 3 V1 Ang	Degrees	Synchrocheck 3 V1 angle
10888	Synchchk 3 V2 Mag	Volts	Synchrocheck 3 V2 mag
10890	Synchchk 3 V2 Ang	Degrees	Synchrocheck 3 V2 angle
10891	Synchchk 3 V2' Mag	Volts	Synchrocheck 3 V2_mag
10893	Synchchk 3 V2' Ang	Degrees	Synchrocheck 3 V2_angle
10894	Synchchk 3 Delta' Phs	Degrees	Synchrocheck 3 delta_phase
10895	Synchchk 3 SSCP DPh'	Degrees	Synchrocheck 3 _synchscope
10896	Synchchk 4 Delta V	Volts	Synchrocheck 4 delta voltage
10898	Synchchk 4 Delta Phs	Degrees	Synchrocheck 4 delta phase
10899	Synchchk 4 SSCP DPh	Degrees	Synchrocheck 4 synchscope
10900	Synchchk 4 Delta F	Hz	Synchrocheck 4 delta frequency
10901	Synchchk 4 V1 Mag	Volts	Synchrocheck 4 V1 mag
10903	Synchchk 4 V1 Ang	Degrees	Synchrocheck 4 V1 angle
10904	Synchchk 4 V2 Mag	Volts	Synchrocheck 4 V2 mag
10906	Synchchk 4 V2 Ang	Degrees	Synchrocheck 4 V2 angle
10907	Synchchk 4 V2' Mag	Volts	Synchrocheck 4 V2_mag
10909	Synchchk 4 V2' Ang	Degrees	Synchrocheck 4 V2_angle
10910	Synchchk 4 Delta' Phs	Degrees	Synchrocheck 4 delta_phase
10911	Synchchk 4 SSCP DPh'	Degrees	Synchrocheck 4 _synchscope
12032	Brk 1 Acc Arc Amp A	kA2-cyc	Breaker 1 Acc arcing amp phase A
12034	Brk 1 Acc Arc Amp B	kA2-cyc	Breaker 1 Acc arcing amp phase B
12036	Brk 1 Acc Arc Amp C	kA2-cyc	Breaker 1 Acc arcing amp phase C
12038	Brk 1 Op Time A	ms	Breaker 1 operating time phase A
12039	Brk 1 Op Time B	ms	Breaker 1 operating time phase B
12040	Brk 1 Op Time C	ms	Breaker 1 operating time phase C
12041	Brk 1 Op Time	ms	Breaker 1 operating time
12042	Brk 1 Arc Amp A	kA2-cyc	Breaker 1 arcing amp phase A
12044	Brk 1 Arc Amp B	kA2-cyc	Breaker 1 arcing amp phase B
12046	Brk 1 Arc Amp C	kA2-cyc	Breaker 1 arcing amp phase C
12048	Brk 1 Amp Max A	kA2-cyc	Breaker 1 amp max phase A
12050	Brk 1 Amp Max B	kA2-cyc	Breaker 1 amp max phase B
12052	Brk 1 Amp Max C	kA2-cyc	Breaker 1 amp max phase C
12054	Brk 2 Acc Arc Amp A	kA2-cyc	Breaker 2 Acc arcing amp phase A

Address	FlexAnalog name	Units	Description
12056	Brk 2 Acc Arc Amp B	kA2-cyc	Breaker 2 Acc arcing amp phase B
12058	Brk 2 Acc Arc Amp C	kA2-cyc	Breaker 2 Acc arcing amp phase C
12060	Brk 2 Op Time A	ms	Breaker 2 operating time phase A
12061	Brk 2 Op Time B	ms	Breaker 2 operating time phase B
12062	Brk 2 Op Time C	ms	Breaker 2 operating time phase C
12063	Brk 2 Op Time	ms	Breaker 2 operating time
12064	Brk 2 Arc Amp A	kA2-cyc	Breaker 2 arcing amp phase A
12066	Brk 2 Arc Amp B	kA2-cyc	Breaker 2 arcing amp phase B
12068	Brk 2 Arc Amp C	kA2-cyc	Breaker 2 arcing amp phase C
12070	Brk 2 Amp Max A	kA2-cyc	Breaker 2 amp max phase A
12072	Brk 2 Amp Max B	kA2-cyc	Breaker 2 amp max phase B
12074	Brk 2 Amp Max C	kA2-cyc	Breaker 2 amp max phase C
12306	Oscill Num Triggers	---	Oscillography number of triggers
13504	DCmA Ip 1	mA	DCmA input 1 actual value
13506	DCmA Ip 2	mA	DCmA input 2 actual value
13508	DCmA Ip 3	mA	DCmA input 3 actual value
13510	DCmA Ip 4	mA	DCmA input 4 actual value
13512	DCmA Ip 5	mA	DCmA input 5 actual value
13514	DCmA Ip 6	mA	DCmA input 6 actual value
13516	DCmA Ip 7	mA	DCmA input 7 actual value
13518	DCmA Ip 8	mA	DCmA input 8 actual value
13520	DCmA Ip 9	mA	DCmA input 9 actual value
13522	DCmA Ip 10	mA	DCmA input 10 actual value
13524	DCmA Ip 11	mA	DCmA input 11 actual value
13526	DCmA Ip 12	mA	DCmA input 12 actual value
13528	DCmA Ip 13	mA	DCmA input 13 actual value
13530	DCmA Ip 14	mA	DCmA input 14 actual value
13532	DCmA Ip 15	mA	DCmA input 15 actual value
13534	DCmA Ip 16	mA	DCmA input 16 actual value
13536	DCmA Ip 17	mA	DCmA input 17 actual value
13538	DCmA Ip 18	mA	DCmA input 18 actual value
13540	DCmA Ip 19	mA	DCmA input 19 actual value
13542	DCmA Ip 20	mA	DCmA input 20 actual value
13544	DCmA Ip 21	mA	DCmA input 21 actual value
13546	DCmA Ip 22	mA	DCmA input 22 actual value
13548	DCmA Ip 23	mA	DCmA input 23 actual value
13550	DCmA Ip 24	mA	DCmA input 24 actual value
13552	RTD Ip 1	---	RTD input 1 actual value
13553	RTD Ip 2	---	RTD input 2 actual value
13554	RTD Ip 3	---	RTD input 3 actual value
13555	RTD Ip 4	---	RTD input 4 actual value
13556	RTD Ip 5	---	RTD input 5 actual value
13557	RTD Ip 6	---	RTD input 6 actual value
13558	RTD Ip 7	---	RTD input 7 actual value
13559	RTD Ip 8	---	RTD input 8 actual value
13560	RTD Ip 9	---	RTD input 9 actual value
13561	RTD Ip 10	---	RTD input 10 actual value

A

Address	FlexAnalog name	Units	Description
13562	RTD Ip 11	---	RTD input 11 actual value
13563	RTD Ip 12	---	RTD input 12 actual value
13564	RTD Ip 13	---	RTD input 13 actual value
13565	RTD Ip 14	---	RTD input 14 actual value
13566	RTD Ip 15	---	RTD input 15 actual value
13567	RTD Ip 16	---	RTD input 16 actual value
13568	RTD Ip 17	---	RTD input 17 actual value
13569	RTD Ip 18	---	RTD input 18 actual value
13570	RTD Ip 19	---	RTD input 19 actual value
13571	RTD Ip 20	---	RTD input 20 actual value
13572	RTD Ip 21	---	RTD input 21 actual value
13573	RTD Ip 22	---	RTD input 22 actual value
13574	RTD Ip 23	---	RTD input 23 actual value
13575	RTD Ip 24	---	RTD input 24 actual value
13576	RTD Ip 25	---	RTD input 25 actual value
13577	RTD Ip 26	---	RTD input 26 actual value
13578	RTD Ip 27	---	RTD input 27 actual value
13579	RTD Ip 28	---	RTD input 28 actual value
13580	RTD Ip 29	---	RTD input 29 actual value
13581	RTD Ip 30	---	RTD input 30 actual value
13582	RTD Ip 31	---	RTD input 31 actual value
13583	RTD Ip 32	---	RTD input 32 actual value
13584	RTD Ip 33	---	RTD input 33 actual value
13585	RTD Ip 34	---	RTD input 34 actual value
13586	RTD Ip 35	---	RTD input 35 actual value
13587	RTD Ip 36	---	RTD input 36 actual value
13588	RTD Ip 37	---	RTD input 37 actual value
13589	RTD Ip 38	---	RTD input 38 actual value
13590	RTD Ip 39	---	RTD input 39 actual value
13591	RTD Ip 40	---	RTD input 40 actual value
13592	RTD Ip 41	---	RTD input 41 actual value
13593	RTD Ip 42	---	RTD input 42 actual value
13594	RTD Ip 43	---	RTD input 43 actual value
13595	RTD Ip 44	---	RTD input 44 actual value
13596	RTD Ip 45	---	RTD input 45 actual value
13597	RTD Ip 46	---	RTD input 46 actual value
13598	RTD Ip 47	---	RTD input 47 actual value
13599	RTD Ip 48	---	RTD input 48 actual value
13600	Ohm Inputs 1 Value	Ohms	Ohm inputs 1 value
13601	Ohm Inputs 2 Value	Ohms	Ohm inputs 2 value
14189	PTP-IRIG-B Delta	ns	PTP time minus IRIG-B time
24432	Communications Group	---	Groups communications group
24447	Active Setting Group	---	Current setting group
32768	Tracking Frequency	Hz	Terminal tracking frequency
39168	FlexElement 1 Value	---	FlexElement 1 actual value
39170	FlexElement 2 Value	---	FlexElement 2 actual value
39172	FlexElement 3 Value	---	FlexElement 3 actual value

Address	FlexAnalog name	Units	Description
39174	FlexElement 4 Value	---	FlexElement 4 actual value
39176	FlexElement 5 Value	---	FlexElement 5 actual value
39178	FlexElement 6 Value	---	FlexElement 6 actual value
39180	FlexElement 7 Value	---	FlexElement 7 actual value
39182	FlexElement 8 Value	---	FlexElement 8 actual value
39184	FlexElement 9 Value	---	FlexElement 9 actual value
39186	FlexElement 10 Value	---	FlexElement 10 actual value
39188	FlexElement 11 Value	---	FlexElement 11 actual value
39190	FlexElement 12 Value	---	FlexElement 12 actual value
39192	FlexElement 13 Value	---	FlexElement 13 actual value
39194	FlexElement 14 Value	---	FlexElement 14 actual value
39196	FlexElement 15 Value	---	FlexElement 15 actual value
39198	FlexElement 16 Value	---	FlexElement 16 actual value
41138	V0 3rd Harmonic 1	Volts	VTFF 1 V0 3rd Harmonic
41140	V0 3rd Harmonic 2	Volts	VTFF 2 V0 3rd Harmonic
41142	V0 3rd Harmonic 3	Volts	VTFF 3 V0 3rd Harmonic
41144	V0 3rd Harmonic 4	Volts	VTFF 4 V0 3rd Harmonic
42400	Volts Per Hertz 1	pu	Volts per hertz 1 actual value
42401	Volts Per Hertz 2	pu	Volts per hertz 2 actual value
45584	RxGOOSE Analog 1	---	RxGOOSE analog input 1
45586	RxGOOSE Analog 2	---	RxGOOSE analog input 2
45588	RxGOOSE Analog 3	---	RxGOOSE analog input 3
45590	RxGOOSE Analog 4	---	RxGOOSE analog input 4
45592	RxGOOSE Analog 5	---	RxGOOSE analog input 5
45594	RxGOOSE Analog 6	---	RxGOOSE analog input 6
45596	RxGOOSE Analog 7	---	RxGOOSE analog input 7
45598	RxGOOSE Analog 8	---	RxGOOSE analog input 8
45600	RxGOOSE Analog 9	---	RxGOOSE analog input 9
45602	RxGOOSE Analog 10	---	RxGOOSE analog input 10
45604	RxGOOSE Analog 11	---	RxGOOSE analog input 11
45606	RxGOOSE Analog 12	---	RxGOOSE analog input 12
45608	RxGOOSE Analog 13	---	RxGOOSE analog input 13
45610	RxGOOSE Analog 14	---	RxGOOSE analog input 14
45612	RxGOOSE Analog 15	---	RxGOOSE analog input 15
45614	RxGOOSE Analog 16	---	RxGOOSE analog input 16
45616	RxGOOSE Analog 17	---	RxGOOSE analog input 17
45618	RxGOOSE Analog 18	---	RxGOOSE analog input 18
45620	RxGOOSE Analog 19	---	RxGOOSE analog input 19
45622	RxGOOSE Analog 20	---	RxGOOSE analog input 20
45624	RxGOOSE Analog 21	---	RxGOOSE analog input 21
45626	RxGOOSE Analog 22	---	RxGOOSE analog input 22
45628	RxGOOSE Analog 23	---	RxGOOSE analog input 23
45630	RxGOOSE Analog 24	---	RxGOOSE analog input 24
45632	RxGOOSE Analog 25	---	RxGOOSE analog input 25
45634	RxGOOSE Analog 26	---	RxGOOSE analog input 26
45636	RxGOOSE Analog 27	---	RxGOOSE analog input 27
45638	RxGOOSE Analog 28	---	RxGOOSE analog input 28

A

Address	FlexAnalog name	Units	Description
45640	RxGOOSE Analog 29	---	RxGOOSE analog input 29
45642	RxGOOSE Analog 30	---	RxGOOSE analog input 30
45644	RxGOOSE Analog 31	---	RxGOOSE analog input 31
45646	RxGOOSE Analog 32	---	RxGOOSE analog input 32

# G30 Generator Protection System

## Appendix B: RADIUS server configuration

This appendix outlines how to set up a RADIUS server for user authentication.

---

### B.1 RADIUS server configuration

The following procedure is an example of how to set up a simple RADIUS server. You install the RADIUS server software on a separate computer. In this example, we use FreeRADIUS third-party software.

1. Download and install FreeRADIUS from [www.freeradius.net](http://www.freeradius.net) as the RADIUS server. This is a Windows 32-bit installation that is known to work. If you try another third-party tool and it does not work, use the FreeRADIUS software from [freeradius.net](http://freeradius.net).

2. Open the radius.conf file in the <Path\_to\_Radius>\etc\raddb folder, locate the "bind\_address" field, and enter your RADIUS server IP address. An example is

```
bind_address = 10.14.61.109
```

Text editor software that supports direct editing and saving of UNIX text encodings and line breaks, such as EditPad Lite, is needed for this editing.

3. In the users.conf file in the <Path\_to\_Radius>\etc\raddb folder, add the following text to configure a user "Tester" with an Administrator role.

```
Tester                User-Password == "testpw"  
                    GE-PDC-USER-RoLe = Administrator,
```

4. In the clients.conf file in the <Path\_to\_Radius>\etc\raddb folder, add the following text to define the UR as a RADIUS client, where the client IP address is 10.0.0.2, the subnet mask is 255.255.255.0, the shared secret specified here is also configured on the UR device for successful authentication, and the shortname is a short, optional alias that can be used in place of the IP address.

```
client 10.0.0.2/24 {  
    secret = testing123  
    shortname = private-network-1  
}
```

5. In the <Path\_to\_Radius>\etc\raddb folder, create a file called dictionary.ge and add the following content.

```
# #####  
# GE VSAS  
#####  
  
VENDOR                GE                2910  
  
# Management authorization
```

```

BEGIN-VENDOR                                GE

# Role ID
ATTRIBUTE                                GE-UR-Role    1            integer

# GE-UR-ROLE values
VALUE GE-UR-Role    Administrator    1
VALUE GE-UR-Role    Supervisor      2
VALUE GE-UR-Role    Engineer        3
VALUE GE-UR-Role    Operator        4
VALUE GE-UR-Role    Observer        5

END-VENDOR                                GE
#####
    
```

B

- In the dictionary file in the <Path\_to\_Radius>\etc\raddb folder, add the following line.

```
$INCLUDE dictionary.ge
```

For example, the file can look like the following:

```
$INCLUDE ../share/freeradius/dictionary
$INCLUDE dictionary.ge
```

- For the first start, run the RADIUS server in debug mode to ensure that there are no compiling errors.

```
<Path_to_Radius>/start_radiusd_debug.bat
```

- Set up the RADIUS parameters on the UR as follows.
  - If logging in, select **Device** for the **Authentication Type**, and use Administrator for the **User Name**. The default password is "ChangeMe1#".
  - Access **Settings > Product Setup > Security**. Configure the IP address and ports for the RADIUS server. Leave the GE vendor ID field at the default of 2910. Update the RADIUS shared secret as specified in the clients.conf file. Restart the relay for the IP address and port changes to take effect.
- Verify operation. Log in to the UR software as follows. In the login window, select **Server** as the **Authentication Type**, enter the user name entered (for example user name Tester and password "testpw"). Check that the RADIUS server log file shows the access with an "Access-Accept" entry.

Recall that if you tried another third-party tool and it did not work, you can use the FreeRADIUS software from freeradius.net.



# G30 Generator Protection System

## Appendix C: Command line interface

This appendix outlines command line access to the software.

---

### C.1 Command line interface

SetupCLI is a command line interface to communicate with the EnerVista UR Setup software. Commands can be sent from a DOS prompt or a Windows batch file.

The interface is installed with the EnerVista software. Its default location is similar to  
C:\Program Files\EnerVista\Tools\SetupCLI

The EnerVista software needs to be installed on a computer to run the command line interface. The command line interface does not provide a remote connection to a computer running the EnerVista software.

Items to note are as follows:

- Works with EnerVista UR Setup version 6.10 and later
- Available in English only
- The graphical user interface of the software is not available concurrently with the command line interface
- It does not support concurrent commands
- It has limited functionality with CyberSentry
- It does not interface with UR Engineer
- It does not work when EnerVista UR Setup security is enabled, meaning when login is required

Command syntax is as follows:

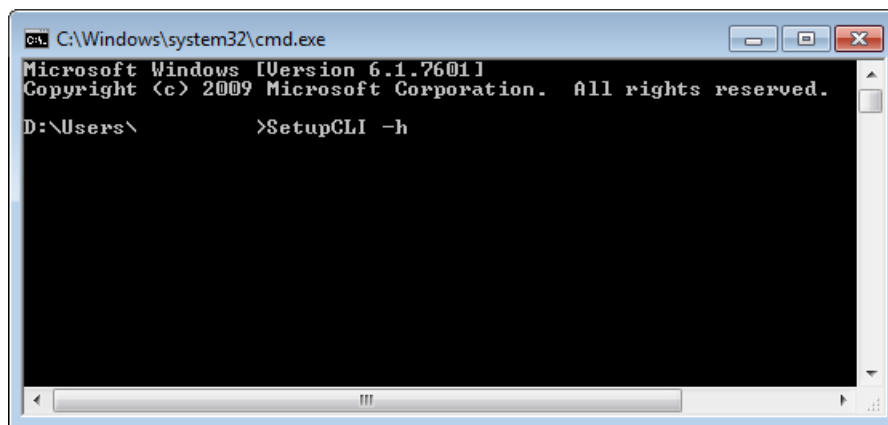
- Options enclosed in [ ] are optional
- Values enclosed in < > are replaced with your own values
- <Application> is replaced with the EnerVista software to receive the command. Use "URPC" for EnerVista UR Setup.
- <device> is the UR device name, as displayed in the **Device Name** field of the Device Setup window and listed in the Online Window. Use quotes with spaces, such as "B30 Belfort".
- "-s" can be used with any command to suppress error messages
- All commands, their return codes, and error description are logged in the file  
C:\ProgramData\EnerVista\Tools\SetupCLI\SetupCLI.log
- When the Supervisor account is enabled, the 'Lock Relay' setting must first be changed to No before the putsettings, inservice, or reboot command can be used. This setting cannot be changed using the command line interface.
- Use quotes ("") to enclose any parameter containing a space

- Commands, options, and parameters are case sensitive
- All commands have a return code of 0-255. 0 indicates success and 1-255 indicate different errors
- If SetupCLI is automated (in a batch file), make sure that only a single batch is running at a time. SetupCLI does not support concurrent operations.

To run the command line interface:

1. In Windows, click the **Start** button, enter **cmd**, and press the **Enter** key. After prompting for permission, the Windows command window opens.
2. Enter **SetupCLI** followed by the action to execute. An example of use is to enter "SetupCLI -h" to display help, specifically the commands and explanations outlined here.

**Figure C-1: Command line interface run in the command window**



### SetupCLI -h

Display help.

It displays the content outline here.

### SetupCLI <Application> start [-c] [-s]

Launch application with name <Application>.

To start in client mode, which is the graphical user interface, include option '-c'. Before use, the software must be idle without any windows open. Any activity or open windows can cause unexpected behavior. When in client mode, do not use Launchpad's Site Management feature.

To suppress errors, include option -s.

Example: SetupCLI URPC start -c

### SetupCLI <Application> exit [-s]

Exit application with name <Application>.

Example: SetupCLI URPC exit

### SetupCLI <Application> login -d <device> [-A <authentication type>] [-a <account>] -w <password> [-s]

Authenticate with device <device> using password <password>.

**For non-CyberSentry devices** — Set <authentication type> to "traditional". Note that <authentication type> defaults to "traditional" if not specified. Set <account> to "COMMANDS" or "SETTINGS". If not specified, the SETTINGS account is used.

Example: SetupCLI URPC login -d "C30 Melbourne" -A traditional -a SETTINGS -w 1password1

Example of a batch file that checks for an error (this batch file uses standard batch file operations to check the return code (ERRORLEVEL) and jump to an error handler):

```
SetupCLI URPC start
SetupCLI URPC login -d demoDevice -a SETTINGS -w WrongPassword -A traditional
IF NOT ERRORLEVEL 0 GOTO FAILED
SetupCLI URPC putsettings -d demoDevice -f "example file.urs"
SetupCLI URPC inservice -d demoDevice
SetupCLI URPC reboot -d demoDevice
SetupCLI URPC exit
exit

:FAILED
echo Please try again
exit
```

**For CyberSentry devices with local authentication** — Set <authentication type> to "local" . Set <account> to "Supervisor", "Administrator", "Engineer", "Operator", or "Observer".

**For CyberSentry devices with RADIUS authentication** — Set <authentication type> to "radius". Set <account> to the user's account on the RADIUS server.

#### SetupCLI <Application> logout -d <device> [-s]

Log out of device <device>.

Example: SetupCLI URPC logout -d C30

#### SetupCLI <Application> getsettings -d <device> -f <File> [-s]

Read settings from device <device> and save them to the .urs file <File>. The <File> must not already exist. The default path to the output file is C:\Users\Public\Public Documents\GE Power Management\URPC\Data

Example: SetupCLI URPC getsettings -d C30 -f "C30 Markham.urs"

Example of a batch file to retrieve a settings file:

```
SetupCLI URPC start
SetupCLI URPC getsettings -d demoDevice -f C:\example.urs
SetupCLI URPC exit
```

Example of a batch file to retrieve a settings file from a relay that requires RADIUS authentication:

```
SetupCLI URPC start
SetupCLI URPC login -d demoDevice -a %1 -w %2 -A radius
SetupCLI URPC getsettings -d demoDevice -f "example file.urs"
SetupCLI URPC logout -d demoDevice
SetupCLI URPC exit
```

Although a user name and password could have been entered in this batch file, it would have created a security risk. Batch files allow you to pass in runtime parameters and refer to them in your script as %1, %2, and so on. For example, if this file is called example.bat, one calls it as follows: "example.bat MyUserName MyPassword"

#### SetupCLI <Application> putsettings -d <device> -f <File> [-s]

Write the settings file <File> to the device <device>.

For CyberSentry devices, putsettings is only supported for users with the "Administrator" role.

Example: SetupCLI URPC putsettings -d C30 -f "C30 Markham.urs"

**SetupCLI <Application> compare -f <File1> -r <File2> -o <OutputFile> [-s]**

Compare settings files <File1> and <File2>, and save output to <OutputFile>.

Example: SetupCLI URPC compare -f may.urs -r september.urs -o compared.txt

Batch file example that retrieves a settings file, compares it with an existing settings file, and opens the resulting comparison file:

```
SetupCLI URPC start
SetupCLI URPC getsettings -d demoDevice -f devicefile.urs
SetupCLI URPC compare -f existingfile.urs -r devicefile.urs -o output.txt
```

The output is similar to the following:

Comparing settings file aaa.urs : C:\Users\Public\Public Documents\GE Power Management\URPC\Data\ with bbb.urs : C:\Users\Public\Public Documents\GE Power Management\URPC\Data\

#	Setting Name	(Group,Module,Item)	Value
1 +	Default Message Timeout	(1,1,1)	= 299 s
2 -	Default Message Timeout	(1,1,1)	= 300 s
3 +	Flash Message Time	(1,1,1)	= 0.9 s
4 -	Flash Message Time	(1,1,1)	= 1.0 s

**SetupCLI <Application> inservice -d <device> [-n] [-s]**

Put the device in service. Include option -n to take the device out of service.

Example: SetupCLI URPC inservice -d C30

**SetupCLI <Application> reboot -d <device> [-s]**

Reboot the relay <device>. This is necessary after changing IEC 61850 settings and aggregator source settings.

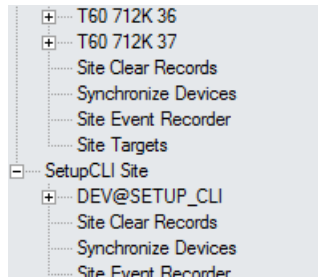
Example: SetupCLI URPC reboot -d "C30\_Instanbul"

**SetupCLI <Application> adddevice -I <IP Address> -S <Slave Address> -P <Modbus Port>**

Connect to a device using its IP address, slave address, and Modbus port. Show the device in the EnerVista interface under the SetupCLI Site as DEV@SETUP\_CLI.

EnerVista UR Setup 7.30 or higher supports this command.

**Figure C-2: Device added using IP address**



The device is named as DEV@SETUP\_CLI, which is used as the device name required by the <device> parameter of other SetupCLI commands.

The device name DEV@SETUP\_CLI is always assigned to the device that is connected most recently by performing 'adddevice' command. It means that the Application only keeps up to one device named as DEV@SETUP\_CLI, the 'adddevice' command disconnects/deletes the device DEV@SETUP\_CLI that was connected previously by performing 'adddevice' command.

The device name DEV@SETUP\_CLI is never used to configure/connect to a device through the graphical user interface.

Example of a batch file using a device IP address to retrieve its settings file:

```
SetupCLI URPC start
SetupCLI URPC adddevice -I 192.168.140.113 -S 113 -P 502
SetupCLI URPC getsettings -d DEV@SETUP_CLI -f C:\example.urs
SetupCLI URPC exit
```

After connecting the device using IP address, the device name DEV@SETUP\_CLI is used to identify this device in 'getsettings' command.

Example of a batch file using a device IP address to retrieve a settings file when RADIUS authentication is required:

```
SetupCLI URPC start
SetupCLI URPC adddevice -I 192.168.140.113 -S 113 -P 502
SetupCLI URPC login -d DEV@SETUP_CLI -a %1 -w %2 -A radius
SetupCLI URPC getsettings -d DEV@SETUP_CLI -f "example file.urs"
SetupCLI URPC logout -d DEV@SETUP_CLI
SetupCLI URPC exit
```

DEV@SETUP\_CLI has to be used as the device name in the commands followed by the 'adddevice' command.



# G30 Generator Protection System

## Appendix D: Miscellaneous

This chapter provides the warranty and revision history.

---

### D.1 Warranty

For products shipped as of 1 October 2013, GE Grid Solutions warrants most of its GE manufactured products for 10 years. For warranty details including any limitations and disclaimers, see the Terms and Conditions at

<http://www.gegridsolutions.com/multilin/warranty.htm>

For products shipped before 1 October 2013, the standard 24-month warranty applies.

---

### D.2 Revision history

The tables outline the releases and revision history of this document.

**Table D-1: Revision history (English)**

Manual P/N	G30 revision	Release date	ECO
1601-0166-J1	4.4x	15 September 2004	URX-156
1601-0166-J2	4.4x	05 January 2005	URX-173
1601-0166-K1	4.6x	15 February 2005	URX-176
1601-0166-L1	4.8x	05 August 2005	URX-202
1601-0166-M1	4.9x	15 December 2005	URX-208
1601-0166-M2	4.9x	27 February 2006	URX-214
1601-0166-N1	5.0x	31 March 2006	URX-217
1601-0166-N2	5.0x	26 May 2006	URX-220
1601-0166-P1	5.2x	23 October 2006	URX-230
1601-0166-P2	5.2x	24 January 2007	URX-232
1601-0166-R1	5.4x	26 June 2007	URX-242
1601-0166-R2	5.4x	31 August 2007	URX-246
1601-0166-R3	5.4x	17 October 2007	URX-251
1601-0166-S1	5.5x	7 December 2007	URX-253
1601-0166-S2	5.5x	22 February 2008	URX-258

Manual P/N	G30 revision	Release date	ECO
1601-0166-S3	5.5x	12 March 2008	URX-260
1601-0166-T1	5.6x	27 June 2008	08-0390
1601-0166-U1	5.7x	29 May 2009	09-0938
1601-0166-U2	5.7x	30 September 2009	09-1165
1601-0166-V1	5.8x	29 May 2010	09-1457
1601-0166-V2	5.8x	04 January 2011	11-2237
1601-0166-W1	5.9x	12 January 2011	11-2227
1601-0166-X1	6.0x	21 December 2011	11-2840
1601-0166-X2	6.0x	5 April 2012	12-3254
1601-0166-Y1	7.0x	30 September 2012	12-3529
1601-0166-Y2	7.0x	11 November 2012	12-3601
1601-0166-Z1	7.1x	30 March 2013	13-0126
1601-0166-AA1	7.2x	1 August 2013	13-0401
1601-0166-AB1	7.3x	7 November 2014	14-1408
1601-0166-AB2	7.3x	1 September 2015	15-2215
1601-0166-AC1	7.40x	8 December 2016	16-3319
1601-0166-AE1	7.41x	31 January 2017	17-3427
1601-0166-AE3	7.4x	28 April 2017	17-3561
1601-0166-AF1	7.6x	30 June 2017	17-3779
1601-0166-AF2	7.6x	31 October 2017	17-3935
1601-0166-AG1	7.7x	31 March 2018	18-4430
1601-0166-AG2	7.7x	4 May 2018	18-4517

**Table D-2: Major changes for G30 manual version AG2 (English)**

Page	Description
---	General revision. Improved figure quality by using conditional text to switch between PDF and PNG figures.

**Table D-3: Major changes for G30 manual version AG1 (English)**

Page	Description
---	General revision
2-9	Updated order codes from SH / SL to RH / RL for the redundant power supply for horizontal units. The power supply modules were upgraded in 2014 to SH and SL, but the order codes when purchasing a UR remain as RH and RL so that customers do not need to change order codes. The order codes for the power supply replacement modules are correct as SH and SL.
3-58	Added IP and subnet mask address rules to the Set IP Address in UR section
5-57	Added IEC 61850 Editions 1 and 2 section
5-112	Added support for a redundant SNTP server as a time source
5-185	Added GOOSE simulation operands to FlexLogic operands table
5-323	Added Settings > Simulation > GOOSE section
6-4	Added Actual Values > Graphical Panel > LEDs and Pushbuttons information
6-13	Added Actual Values > Status > Protocol section

**Table D-4: Major changes for G30 manual version AF2 (English)**

Page	Description
---	General revision
---	Added type W CPU module to order codes in chapter 2, installation chapter 3, Replace Front Panel section in chapter 10



Page	Description
---	Added Japanese and Polish languages and modules 6W and 6X to order codes in chapter 2. Module 6W allows 30 contact inputs, and Module 6X allows 18 outputs.
3-19	Added contact input and contact output modules 6W and 6X to Table 3-3 Contact Input and Output Module Assignments and to Figure 3-19 Contact Input and Output Module Wiring (Sheet 3 of 3)
5-299	Updated Thermal Overload Protection Logic diagram

Table D-5: Major changes for G30 manual version AF1 (English)

Page	Description
---	General revision
---	Updated "faceplate" to "front panel" for consistency and to reflect web site
---	Added graphical front panel option to order codes and specifications in chapter 2, Interfaces chapter 4, Settings chapter 5, Actual Values chapter 6
---	Added PEAP-GTC and PAP protocols for authenticating user logins when using a RADIUS server. Added to Settings > Product Setup > Security > RADIUS Authentication Method and to Modbus memory map and F codes.
---	Updated Contact Inputs from 96 to 120 and Contact Outputs from 64 to 72 in Product Description in chapter 2 and FlexLogic operands table in chapter 5
---	Updated Current CT Settings number from 4 to 6 in FlexLogic operands table, settings, features per product table, and Modbus memory map
---	Updated Phase Instantaneous Overcurrent number from 4 to 12 in FlexLogic operands table, settings, features per product table, Modbus memory map
---	Updated Phase Time Overcurrent number from 2 to 6 in FlexLogic operands table, settings, features per product table, Modbus memory map
3-38	Updated RS422 and Fiber Interface Connection figure for the clock channels (from 7a and 7b to 1a and 1b)
3-69	Added Connect to a D400 Gateway section
4-43	Updated LED Labelling instructions for the new Front Panel Label Designer
4-50	Added Standard Front Panel section for labelling LEDs and pushbuttons
5-105	Added USB Port section to enable/disable the USB port on the graphical front panel
5-120	Updated User-programmable Pushbuttons section as per specifications
5-153	Updated Breakers section as per specifications
5-158	Updated Disconnect Switches section as per specifications
10-	Added Theory of Operation chapter in order to add Saturation Detector section
11-5	Added Convert Device Settings section
11-7	Added Copy Settings to Other Device section
11-15	Added Replace Front Panel section for retrofit with the new graphical front panel

Table D-6: Major changes for G30 manual version AE3 (English)

Page	Description
	General revision
2-	Updated order codes
10-	Added Theory of Operation chapter in order to add Saturation Detector section
11-5	Added Copy Settings to Other Device section

Table D-7: Major changes for G30 manual version AE1 (English)

Page	Description
---	General revision
---	Added routable GOOSE content in chapters 2 and 5
3-38	Updated RS422 and Fiber Interface Connection figure for the clock channels (from 7a and 7b to 1a and 1b)
4-	Added Engineer content
5-	Updated IEC 61850 content

Page	Description
A-	Updated FlexAnalog table for most UR products

**Table D-8: Major changes for G30 manual version AC1 (English)**

Page	Description
---	General revision. Added online help and updated generic online help.
---	Deleted EAC logo from title page and deleted EAC certification from Approvals specifications because document not translated into Russian
---	Updated Synchrocheck content including settings, logic diagram, actual values, and number of elements from four to six in interface chapter, FlexLogic operands table, settings, actual values, FlexAnalog table, features per product table, Modbus memory map, IMD tables
---	Added Breaker Arcing Current content to product description, specifications, FlexLogic operands table, settings, FlexElement tables, actual values, FlexAnalog table, features per product table, Modbus memory map, IMD table
---	Added Transformer Thermal Inputs content to settings, actual values, features per product table, Modbus memory map, IMD tables
---	Added Transformer Hottest-Spot temperature, Transformer Aging Factor, Transformer Loss of Life content to description, specifications, FlexLogic operands table, actual values, FlexAnalog table, Modbus memory map, IMD tables
---	Updated transformer Percent Differential element (for CT Saturation), including 1-out-of-3, including in specifications, FlexLogic operands, settings, logic diagram, and added actual values
---	Updated Disconnect (Breaker) Switch number from 16 to 8 in FlexLogic operands table, settings, features per product table, Modbus memory map
---	Updated Neutral Time Overcurrent (TOC) number from 1 to 2 in FlexLogic operands table, settings, features per product table, Modbus memory map
---	Updated Phase Time Overcurrent (TOC) number from 1 to 2 in FlexLogic operands table, settings, features per product table, Modbus memory map
---	Updated number of Phase Instantaneous Overcurrent elements in FlexLogic operands table, settings, features per product table, Modbus memory map
2-	Updated several specifications, such as TOC, IOC, number of FlexLogic lines
5-38	Added PRT FUNCTION settings in Network section to enable/disable each Ethernet port
5-49	Updated IEC 61850 section
5-61	Added Support for Routable GOOSE section
5-177	Updated number of FlexLogic lines from 512 to 1024 in FlexLogic Equation Editor settings section
10-1	Added Monitoring section
10-2	Added Retrieve Files section
C-	Added Command Line Interface appendix



# G30 Generator Protection System

## Abbreviations

A	Ampere	CPU	Central Processing Unit
AC	Alternating Current	CRC	Cyclic Redundancy Code/Check
A/D	Analog to Digital	CRL	Certificate Revocation List
AE	Accidental Energization, Application Entity	CRT, CRNT	Current
AMP	Ampere	CSA	Canadian Standards Association
ANG	Angle	CT	Current Transformer
ANSI	American National Standards Institute	CVT	Capacitive Voltage Transformer
AR	Automatic Reclosure		
ARP	Address Resolution Protocol	D/A	Digital to Analog
ASDU	Application-layer Service Data Unit	DC (dc)	Direct Current
ASYM	Asymmetry	DCE	Data Communications Equipment
AUTO	Automatic	DCS	Distributed Control System
AUX	Auxiliary	DD	Disturbance Detector
AVG	Average	DFLT	Default
AWG	American Wire Gauge	DGNST	Diagnostics
		DIFF	Differential
BCS	Best Clock Selector	DIR	Directional
BER	Bit Error Rate	DISCREP	Discrepancy
BF	Breaker Fail	DIST	Distance
BFI	Breaker Failure Initiate	DMD	Demand
BKR	Breaker	DNP	Distributed Network Protocol
BLK	Block	DPO	Dropout
BLKG	Blocking	DPS	Double-Point Status
BNC	Bayonet Neill-Concelman	DSP	Digital Signal Processor
BPNT	Breakpoint of a characteristic	DST	Daylight Savings Time
BRKR	Breaker	dt	Rate of Change
		DTT	Direct Transfer Trip
		DUTT	Direct Under-reaching Transfer Trip
CA	Certificate Authority		
CAP	Capacitor	EGD	Ethernet Global Data
CC	Coupling Capacitor	ENCRMNT	Encroachment
CCVT	Coupling Capacitor Voltage Transformer	EPRI	Electric Power Research Institute
CFG	Configure / Configurable	.EVT	Filename extension for event recorder files
.CFG	Filename extension for oscillography files	EXT	Extension, External
CHK	Check		
CHNL	Channel	F	Field
CID	Configured IED Description	FAIL	Failure
CLS	Close	FD	Fault Detector
CLSD	Closed	FDH	Fault Detector high-set
CMND	Command	FDL	Fault Detector low-set
CMPRSN	Comparison	FIR	Finite Impulse Response
CO	Contact Output	FLA	Full Load Current
COM	Communication	FO	Fiber Optic
COMM	Communications	FPGA	Field-programmable Gate Array
COMP	Compensated, Comparison	FREQ	Frequency
CONN	Connection	FSK	Frequency-Shift Keying
CONT	Continuous, Contact	FTP	File Transfer Protocol
CO-ORD	Coordination	FxE	FlexElement™

FWD	Forward	M2M	Machine to Machine
G	Generator	mA	MilliAmpere
GCM	Galois Counter Mode	MAG	Magnitude
GDOI	Group Domain of Interpretation	MAN	Manual / Manually
GE	General Electric	MAX	Maximum
GFP	Graphical Front Panel	Mb	Megabit
GND	Ground	MIC	Model Implementation Conformance
GNTR	Generator	MIN	Minimum, Minutes
GoCB	GOOSE Control Block	MMI	Man Machine Interface
GOOSE	General Object Oriented Substation Event	MMS	Manufacturing Message Specification
GPS	Global Positioning System	MRT	Minimum Response Time
GSU	Generator Step-Up	MSG	Message
		MTA	Maximum Torque Angle
HARM	Harmonic / Harmonics	MTR	Motor
HCT	High Current Time	MVA	MegaVolt-Ampere (total 3-phase)
HGF	High-Impedance Ground Fault (CT)	MVA_A	MegaVolt-Ampere (phase A)
HIZ	High-Impedance and Arcing Ground	MVA_B	MegaVolt-Ampere (phase B)
HMI	Human-Machine Interface	MVA_C	MegaVolt-Ampere (phase C)
HTTP	Hyper Text Transfer Protocol	MVAR	MegaVar (total 3-phase)
HV	High Voltage	MVAR_A	MegaVar (phase A)
HYB	Hybrid	MVAR_B	MegaVar (phase B)
Hz	Hertz	MVAR_C	MegaVar (phase C)
		MVARH	MegaVar-Hour
I	Instantaneous	MW	MegaWatt (total 3-phase)
I_0	Zero Sequence current	MW_A	MegaWatt (phase A)
I_1	Positive Sequence current	MW_B	MegaWatt (phase B)
I_2	Negative Sequence current	MW_C	MegaWatt (phase C)
IA	Phase A current	MWH	MegaWatt-Hour
IAB	Phase A minus B current		
IB	Phase B current	N	Neutral
IBC	Phase B minus C current	N/A, n/a	Not Applicable
IC	Phase C current	NEG	Negative
ICA	Phase C minus A current	NMPLT	Nameplate
ICD	IED Capability Description	NOM	Nominal
ID	Identification	NTR	Neutral
IED	Intelligent Electronic Device	O	Over
IEC	International Electrotechnical Commission	OC, O/C	Overcurrent
IEEE	Institute of Electrical and Electronic Engineers	OCSP	Online Certificate Status Protocol
IG	Ground (not residual) current	OF	Overload Factor
Igd	Differential Ground current	O/P, Op	Output
IGMP	Internet Group Management Protocol	OP	Operate
IID	Instantiated IED Capability Description	OPER	Operate
IN	CT Residual Current (3I <sub>0</sub> ) or Input	OPERATG	Operating
INC SEQ	Incomplete Sequence	O/S	Operating System
INIT	Initiate	OSI	Open Systems Interconnect
INST	Instantaneous	OSB	Out-of-Step Blocking
INV	Inverse	OUT	Output
I/O	Input/Output	OV	Overvoltage
IOC	Instantaneous Overcurrent	OVERFREQ	Overfrequency
IOV	Instantaneous Overvoltage	OVLD	Overload
IRC	Inter-Relay Communication		
IRIG	Inter-Range Instrumentation Group	P	Phase
ISO	International Standards Organization	PC	Phase Comparison, Personal Computer
IUV	Instantaneous Undervoltage	PCNT	Percent
		PF	Power Factor (total 3-phase)
K0	Zero Sequence Current Compensation	PF_A	Power Factor (phase A)
kA	kiloAmpere	PF_B	Power Factor (phase B)
KDC	Key Distribution Center	PF_C	Power Factor (phase C)
kV	kiloVolt	PFLL	Phase and Frequency Lock Loop
		PHS	Phase
LCD	Liquid Crystal Display	PICS	Protocol Implementation & Conformance Statement
LED	Light Emitting Diode		
LEO	Line End Open	PKI	Public Key Infrastructure
LFT BLD	Left Blinder	PKP	Pickup
LOOP	Loopback	PLC	Power Line Carrier
LPU	Line Pickup	POS	Positive
LRA	Locked-Rotor Current	POTT	Permissive Over-reaching Transfer Trip
LTC	Load Tap-Changer	PRESS	Pressure
LV	Low Voltage	PRI	Primary
		PROT	Protection
M	Machine	PRP	Parallel Redundancy Protocol

## ABBREVIATIONS

PSEL	Presentation Selector	TRANSF	Transfer
PTP	Precision Time Protocol	TSEL	Transport Selector
pu	Per Unit	TUC	Time Undercurrent
PUIB	Pickup Current Block	TUV	Time Undervoltage
PUIT	Pickup Current Trip	TX (Tx)	Transmit, Transmitter
PUSHBTN	Pushbutton		
PUTT	Permissive Under-reaching Transfer Trip	U	Under
PWM	Pulse Width Modulated	UC	Undercurrent
PWR	Power	UCA	Utility Communications Architecture
		UDP	User Datagram Protocol
QUAD	Quadrilateral	UL	Underwriters Laboratories
		UNBAL	Unbalance
R	Rate, Reverse	UR	Universal Relay
RA	Registration Authority	URC	Universal Recloser Control
RCA	Reach Characteristic Angle	.URS	Filename extension for settings files
REF	Reference	UV	Undervoltage
REM	Remote		
REV	Reverse	V/Hz	Volts per hertz
R-GOOSE	Routable GOOSE	V_0	Zero Sequence voltage
RI	Reclose Initiate	V_1	Positive Sequence voltage
RIP	Reclose In Progress	V_2	Negative Sequence voltage
RGT BLD	Right Blinder	VA	Phase A voltage
RMA	Return Materials Authorization	VAB	Phase A to B voltage
RMS	Root Mean Square	VAG	Phase A to Ground voltage
ROCOF	Rate of Change of Frequency	VARH	Var-hour voltage
ROD	Remote Open Detector	VB	Phase B voltage
RRTD	Remote Resistance Temperature Detector	VBA	Phase B to A voltage
RST	Reset	VBG	Phase B to Ground voltage
RSTR	Restrained	VC	Phase C voltage
RTD	Resistance Temperature Detector	VCA	Phase C to A voltage
RTU	Remote Terminal Unit	VCG	Phase C to Ground voltage
RX (Rx)	Receive, Receiver	VF	Variable Frequency
		VIBR	Vibration
s	second	VT	Voltage Transformer
S	Sensitive	VTFF	Voltage Transformer Fuse Failure
SAT	CT Saturation	VTLOS	Voltage Transformer Loss Of Signal
SBO	Select Before Operate		
SCADA	Supervisory Control and Data Acquisition	WDG	Winding
SCC	Serial Communication Controller	WH	Watt-hour
SCD	System Configuration Description	w/ opt	With Option
SCL	Substation Configuration Language	WGS	World Geodetic System
SCEP	Simple Certificate Enrollment Protocol	WRT	With Respect To
SEC	Secondary		
SEL	Select / Selector / Selection	X	Reactance
SENS	Sensitive	XDUCER	Transducer
SEQ	Sequence	XFMR	Transformer
SFTP	Secure Shell (SSH) File Transfer Protocol, Secure File Transfer Protocol		
		Z	Impedance, Zone
SIR	Source Impedance Ratio		
SNTP	Simple Network Time Protocol		
SRC	Source		
SSB	Single Side Band		
SSEL	Session Selector		
STATS	Statistics		
SUPN	Supervision		
SUPV	Supervise / Supervision		
SV	Supervision, Service		
SYNC	Synchrocheck		
SYNCHCHK	Synchrocheck		
T	Time, transformer		
TC	Thermal Capacity		
TCP	Transmission Control Protocol		
TCU	Thermal Capacity Used		
TD MULT	Time Dial Multiplier		
TEMP	Temperature		
TFTP	Trivial File Transfer Protocol		
THD	Total Harmonic Distortion		
TMR	Timer		
TOC	Time Overcurrent		
TOV	Time Overvoltage		
TRANS	Transient		



# G30 Generator Protection System

## Index

---

### Numerics

10BASE-F settings .....	5-45
4L Discrepancy message .....	7-8
7R module .....	3-42
7S module .....	3-41

---

### A

AC current inputs	
explained .....	3-18
settings .....	5-144
specifications .....	2-29
AC voltage input specifications .....	2-29
Accents .....	4-55
Access Violation message .....	3-68
Accidental energization	
FlexLogic operands .....	5-180
logic diagram .....	5-262
settings .....	5-261
specifications .....	2-25
Acknowledge alarm .....	6-4
Activate relay .....	3-54
Active setting group .....	5-202
Actual values .....	6-1
alarms for graphical front panel .....	6-3
display on graphical front panel .....	4-34, 4-35
monitor with Modbus Analyzer .....	11-1
not activated graphical front panel .....	4-52
Add Device from File option	
restore settings to online device .....	11-11
save to Offline Window .....	3-72
Add Device to Offline Window preferences .....	11-9
Add module, check settings not defaulted .....	11-25
Add relay .....	3-57

Administrator	
add user account .....	5-14
command to force logoff .....	7-4
no automatic logout from front panel .....	5-21
role for CyberSentry .....	2-6
Aging factor	
actual values .....	6-17
FlexLogic operands .....	5-186
logic diagram .....	5-209
settings .....	5-208
specifications .....	2-24
Alarm LEDs .....	5-123
Alarms	
acknowledge .....	4-33, 6-3, 6-4
add .....	4-34, 5-36
messages .....	7-6
overview .....	4-31
reset .....	4-33, 6-4
AND gate explained .....	4-82
Annunciator editor .....	4-34
ANSI device numbers .....	2-2
Apparent power	
actual values .....	6-20
specifications .....	2-29
Application examples	
breaker trip circuit integrity .....	5-291
contact inputs .....	5-305
direct inputs and outputs .....	5-312
latching outputs .....	5-308
sensitive directional power .....	5-264
Apply settings to other device .....	11-7
Approvals .....	2-39
Architecture, relay .....	5-177
Arcing current .....	5-295
Audit list of port numbers .....	5-45
Authentication by device or server .....	5-16
Automatic discovery of UR devices .....	3-67

- Auxiliary overvoltage
    - FlexLogic operands ..... 5-180
    - logic ..... 5-255
    - settings ..... 5-254
    - specifications ..... 2-23
  - Auxiliary undervoltage
    - FlexLogic operands ..... 5-180
    - logic diagram ..... 5-254
    - settings ..... 5-253
    - specifications ..... 2-22
  - Auxiliary voltage channel ..... 3-18
  - Auxiliary voltage metering ..... 6-20
  - AWG wire size ..... 3-48
    - CT/VT ..... 3-18
    - F485 converter ..... 3-55
    - G.703 interface ..... 3-41
    - module 7S ..... 3-41
    - modules 6X, 6W ..... 3-22
    - modules 7E, 7F, 7G, 7Q, 75 ..... 3-48
    - modules 7L, 7M, 7N, 7P, 74 ..... 3-47
    - modules 7T, 7W ..... 3-45
    - RS422 and fiber interface ..... 3-47
- 
- B**
- Back up settings ..... 5-59, 11-9
  - Bad IRIG-B Signal message ..... 7-8
  - Bad PTP Signal message ..... 7-8
  - Banks ..... 5-7, 5-144
  - Basic front panel
    - dimensions ..... 3-2
    - FlexLogic ..... 5-180
    - interface ..... 4-15
    - IP rating ..... 2-37
    - keypad ..... 4-37
    - labels ..... 4-47
    - LEDs ..... 4-39, 5-123
    - navigation ..... 4-49
    - order codes ..... 2-9
    - pushbuttons ..... 5-126
    - specifications ..... 2-27
    - use, change setting ..... 4-51
  - Battery
    - disposal ..... 11-27
    - replace ..... 11-26
  - Baud rate ..... 5-42
  - Blinking alarm ..... 4-33
  - Block setting ..... 5-5
  - Breaker arcing current
    - actual values ..... 6-29
    - FlexAnalog ..... A-22
    - FlexLogic operands ..... 5-180
    - logic diagram ..... 5-297
    - measurement ..... 5-296
    - settings ..... 5-295
    - specifications ..... 2-25
  - Breaker control
    - control of two breakers ..... 4-57
    - dual breaker logic ..... 5-163
    - FlexLogic operands ..... 5-181
    - settings ..... 5-160
    - with IEC 61850 ..... 5-90
  - Breaker-and-a-half scheme ..... 5-6
  - Brick Trouble message ..... 7-13
  - Brightness ..... 5-26
- 
- C**
- C37.94 communications ..... 3-49, 3-52
  - Cannot log in ..... 2-6
  - Caution symbol in Offline Window ..... 4-68
  - CE certification ..... 2-39
  - Certification ..... 2-39
  - Changes ..... D-1
  - Channel
    - banks ..... 5-144
    - tests ..... 6-11
  - Check Settings message ..... 7-7
  - Chinese limited to 10 character input ..... 5-27
  - CID file, SCD file ..... 5-76, 5-77, 5-78
  - CID files
    - create ..... 5-59
    - explained ..... 3-72
    - import ..... 3-72, 11-12
    - import preferences ..... 11-9
    - view ..... 5-59
  - Circuit monitoring applications ..... 5-290
  - Cleaning ..... 2-39
  - Clear
    - files and records ..... 11-30
    - LEDs ..... 5-310
    - relay records using IEC 61850 ..... 5-95
    - relay records using settings ..... 5-40
    - security logs ..... 7-4
  - Clock
    - actual values ..... 6-8
    - graphical front panel format ..... 5-30
    - IRIG-B ..... 3-37
    - PTP ..... 5-111
    - set ..... 7-3
    - settings ..... 5-110
    - synchronize several devices ..... 5-111
  - Close
    - HTTP port ..... 5-100
    - IEC 60870-5-104 port ..... 5-102
    - Modbus port ..... 5-51
    - TFTP port ..... 5-101
    - Web access port ..... 5-100
  - COMM Path Incomplete message ..... 7-8, 7-10
  - Comm status remaining connections ..... 6-11
  - Command line interface to software ..... C-1
  - Command password ..... 4-58, 5-10



Commands	
control user accounts .....	5-14
menu .....	7-1
with IEC 61850 .....	5-95
Commissioning .....	9-1
Communications	
10BASE-F .....	5-45
connecting to the UR .....	3-65, 3-68
DNP .....	5-52
EGD .....	5-103
HTTP .....	5-100
IEC 60870-5-10 .....	5-104
IEC 60870-5-104 .....	5-101
inter-relay specifications .....	2-35
Modbus registers .....	5-109
Modbus settings .....	5-51
modem .....	3-66
Protocol selection .....	5-51
RS232 .....	3-34, 5-42
RS485 .....	3-36, 5-42
settings .....	5-45, 5-52
specifications .....	2-34, 2-35
timeout .....	5-51
web server .....	5-100
Compare settings .....	11-7
Compliance .....	2-39
COMTRADE files, view .....	4-79
Conducted RFI specifications .....	2-38
Connect, unable to .....	3-68, 5-45
Connection timeout .....	5-51
Connectors, LC and ST .....	3-13
Contact inputs	
actual values .....	6-5
explained .....	5-304
FlexLogic operands .....	5-186
settings .....	5-303
specifications .....	2-30
thresholds .....	5-304
wet and dry connections .....	3-27
Contact outputs	
actual values .....	6-6
explained .....	5-307
FlexLogic operands .....	5-186
settings .....	5-306
Control elements .....	5-268
Control power	
description .....	3-16
specifications .....	2-33
Control pushbuttons	
FlexLogic operands .....	5-180
logic diagram .....	5-126
settings .....	5-125
specifications .....	2-27
Convert device settings .....	11-5
Copy of Copy of .....	11-7
Copy settings for upgrading .....	11-5
Copy settings to other device .....	11-7
Counters	
actual values .....	6-7
settings .....	5-292
CPU module diagram .....	3-12
CPU, new types T, U, V .....	11-16
CRC alarm .....	5-140
Critical failure relay specifications .....	2-32
CSA certification .....	2-39
CT bank settings .....	5-144
CT failure	
FlexLogic operands .....	5-181
logic diagram .....	5-299
settings .....	5-298
CT inputs .....	3-17, 5-7, 5-144
CT wiring .....	3-18
Current bank .....	5-144
Current harmonics specifications .....	2-29
Current metering actual values .....	6-18
Curves	
definite time .....	5-215, 5-248
FlexCurves .....	5-170, 5-215
IAC .....	5-213
IEC .....	5-212
IEEE .....	5-211
inverse time undervoltage .....	5-248
types .....	5-210
Cutout, panel .....	3-2
CyberSentry	
FlexLogic operands .....	5-180
installation .....	3-71, 5-24
RS485 port limitation .....	5-17
security commands .....	7-4
security overview .....	2-6
software options .....	2-36
specifications .....	2-36
system logs .....	5-25

---

**D**

D400 connection .....	3-73
Dark graphical front panel .....	5-31
Data logger	
actual values .....	6-29
clearing .....	5-41, 7-2
settings .....	5-118
specifications .....	2-28
Data, reading values .....	6-1
Dataset member is empty message .....	5-68
Date	
firmware .....	6-31
last cleared fault report date .....	6-26
last cleared oscillography date .....	6-28
last fault report date .....	6-26
last settings change .....	6-30
manufacturing date .....	6-30
set .....	5-29, 5-110, 7-3

DCmA inputs .....	6-26
actual values .....	6-26
FlexAnalog .....	A-23
settings .....	5-317
specifications .....	2-30
DCmA outputs .....	
description .....	3-32
settings .....	5-319
specifications .....	2-33
Decommission .....	11-30
Default password .....	5-14
Default settings .....	11-7, 11-9
Default settings to factory default .....	7-3
Definite time curve .....	5-215, 5-248
Delete files and records .....	5-40, 11-30
Deploy relay .....	9-1
Deploy settings .....	11-7
Device authentication .....	5-16
Device Connectivity Report in Engineer .....	4-76
Device information files .....	1-2, 4-76
Device overview .....	11-1
Device setup .....	3-67
Diagnostic Alarm COP message .....	7-7
Diagnostic Alarm DSP message .....	7-7
Diagnostic Failure message .....	7-6
Diagnostics Failure message .....	7-8
Dielectric strength .....	3-15
Differential .....	
actual values .....	6-17
calculations .....	5-204
characteristics .....	5-205
logic diagram .....	5-207
percent .....	5-203
settings .....	5-203
transformer .....	5-151, 5-159, 5-203
Digital counters .....	
actual values .....	6-7
FlexLogic operands .....	5-181
logic diagram .....	5-294
settings .....	5-292
Digital elements .....	
application example .....	5-291
FlexLogic operands .....	5-181
logic diagram .....	5-290
settings .....	5-289
Digital outputs .....	
see Contact outputs .....	
Dimensions .....	3-2
Direct Device Off message .....	7-8
Direct devices .....	
settings .....	5-311
status .....	6-10
Direct I/O .....	
application example .....	5-312
configuration examples .....	5-136
settings .....	5-311
Direct inputs .....	
actual values .....	6-9
application example .....	5-312
clearing counters .....	7-2
FlexLogic operands .....	5-187
settings .....	5-311
specifications .....	2-30
Direct outputs .....	
application example .....	5-312
clearing counters .....	7-2
settings .....	5-312
specifications .....	2-33
Direct Ring Break message .....	7-8
Directional overcurrent .....	
see Phase, Ground, and Neutral directional .....	
Directional polarization .....	5-219
Directional power, sensitive actual values .....	6-25
Directional power, sensitive specifications .....	2-22
Disconnect switch .....	
FlexLogic operands .....	5-185
logic .....	5-168
settings .....	5-165
Discover button .....	3-67
Disk space required .....	3-56
Display settings .....	5-26
Disposal .....	11-32
Dispose of battery .....	11-27
Disturbance detector .....	
FlexLogic operands .....	5-184
internal .....	5-147
DNP .....	
connections remaining .....	6-11
select protocol .....	5-51
settings .....	5-52
view Points List in web browser .....	5-55
DOS Partition Alarm message .....	7-8
Downgrade .....	
firmware .....	11-14
software .....	11-13
Download .....	
files from relay .....	11-3
settings to relay .....	11-7
Drag and drop files .....	4-3
Duplicate .....	
device settings .....	11-7
settings for upgrading .....	11-5
<hr/>	
<b>E</b> .....	
Edition 1 and 2 IEC 61850 .....	5-57
EGD protocol .....	
actual values .....	6-10
settings .....	5-103
Electrostatic discharge specifications .....	2-38
Elements .....	5-4
End of life .....	11-32

Energy metering	
actual values .....	6-21
clearing .....	5-41, 7-2
specifications .....	2-29
EnerVista UR setup	
command line interface .....	C-1
drag and drop files .....	4-3
event recorder .....	4-2
firmware upgrade or downgrade .....	11-14
installation .....	3-56
oscillography .....	4-2
requirements .....	3-56
restart relay .....	5-1
Engineer	
command to force user logoff .....	7-4
create logic diagram .....	4-61
Error messages .....	4-69
toolbar .....	4-80
Warning messages .....	4-70
Enhanced front panel	
FlexLogic .....	5-180
interface .....	4-15
IP rating .....	2-37
keypad .....	4-37
labels .....	4-43
LEDs .....	4-38, 5-123
navigation .....	4-49
order codes .....	2-9
pushbuttons .....	5-126
Rev. 1 and 2 explained .....	3-2
specifications .....	2-27
use, change setting .....	4-51
Environment backup .....	11-9
Equations	
definite time curve .....	5-215, 5-248
FlexCurves .....	5-215
FlexLogic .....	5-196
FlexLogic, protect .....	4-9
IAC curves .....	5-213
IEC curves .....	5-212
IEEE curves .....	5-211
Equipment Mismatch message .....	7-6, 7-12
Error messages .....	7-6
device not recognized .....	11-14
in Engineer .....	4-69
Ethernet	
actual values .....	6-8
configuration .....	3-65
port failure monitoring .....	5-38
port settings .....	5-45
port, turn on or off .....	5-45
ports on rear panel .....	3-12
Quick Connect .....	3-70
Ethernet Global Data settings .....	5-103
Event cause indicators .....	4-38
Event Cause LEDs .....	4-40
Event recorder	
actual values .....	6-27
clearing .....	5-41, 7-2
records explained .....	4-2
specifications .....	2-28
system logs .....	5-25
via EnerVista software .....	4-2
view event records .....	6-27
Events setting .....	5-5
Excitation, loss of	
characteristics .....	5-260
FlexLogic operands .....	5-182
logic diagram .....	5-261
settings .....	5-259
specifications .....	2-25
Export settings to file .....	11-9
<hr/>	
<b>F</b>	
F485 .....	3-55
Factory default reset .....	5-8, 5-22, 7-3
Far-End Fault Indication .....	5-46
Fast form-C relay specifications .....	2-32
Fast transient testing specifications .....	2-38
Features .....	2-1
Fiber signal loss detection .....	5-46
File transfer by IEC 61850 .....	5-99
File transfer by TFTP .....	5-101
Files	
delete .....	11-30
download from relay .....	11-3
drag and drop .....	4-3
protect FlexLogic with password .....	4-9
protect with password .....	4-7
transfer from relay .....	4-17
transfer to relay .....	4-1, 4-17
Firmware not supported by EnerVista .....	11-15
Firmware revision .....	6-31
Firmware upgrade or downgrade .....	11-14
Firmware version does not match EnerVista .....	11-14
First Ethernet Fail	
error message .....	7-8
set alarm .....	5-38
Flash memory .....	11-30
Flash memory data storage .....	3-17
Flash messages .....	5-26
Flex State parameters	
actual values .....	6-8
settings .....	5-132
specifications .....	2-26
FlexAnalog parameters .....	A-1
FlexCurves	
equation .....	5-215
settings .....	5-170
specifications .....	2-26
table .....	5-170

- FlexElements
    - actual values ..... 6-24
    - direction ..... 5-198
    - FlexAnalogs ..... A-24
    - FlexLogic operands ..... 5-182
    - hysteresis ..... 5-198
    - logic diagram ..... 5-197
    - pickup ..... 5-198
    - settings ..... 5-196
    - specifications ..... 2-26
  - FlexLogic
    - create logic diagram with Engineer ..... 4-61
    - edit with equation editor ..... 5-196
    - equation editor ..... 5-196
    - equation example ..... 5-271
    - error message ..... 7-7
    - evaluation ..... 5-190
    - example ..... 5-191
    - gate characteristics ..... 5-189
    - lock equations ..... 4-9
    - lock equations to serial number ..... 4-11
    - operands ..... 5-179
    - operators ..... 5-189
    - rules ..... 5-190
    - security ..... 4-9
    - specifications ..... 2-26
    - status in single-line diagram of graphical front panel ... 4-31
    - timer settings ..... 5-196
    - worksheet ..... 5-193
  - Force contact inputs ..... 5-324
  - Force contact outputs ..... 5-324
  - Foreign language
    - keyboard ..... 4-55
    - setting ..... 5-26
  - Form-A relay
    - actual values ..... 6-6
    - high-impedance circuits ..... 3-21
    - outputs ..... 3-20
    - specifications ..... 2-32
  - Form-C
    - actual values ..... 6-6
    - critical failure relay ..... 3-16
    - order codes ..... 2-9
    - outputs ..... 3-20
    - replacement modules ..... 2-15
    - specifications ..... 2-32
  - FPGA
    - revision ..... 6-31
    - upgrade ..... 11-16
  - Frequency metering
    - actual values ..... 6-21
    - specifications ..... 2-29
  - Frequency out-of-band accumulation
    - actual values ..... 6-24
    - clearing ..... 7-2
    - FlexLogic operands ..... 5-182
    - logic diagram ..... 5-283
    - settings ..... 5-282
    - specifications ..... 2-25
  - Frequency rate of change
    - actual values ..... 6-24
    - FlexAnalogs ..... A-2
    - FlexLogic operands ..... 5-182
    - logic diagram ..... 5-281
    - settings ..... 5-280
    - specifications ..... 2-24
  - Frequency specifications ..... 2-30
  - Frequency testing ..... 9-1
  - Frequency tracking ..... 6-23
  - Frequency, nominal ..... 5-145
  - Front panel ..... 3-2
    - clear ..... 5-310
    - custom labels ..... 4-43
    - dimensions ..... 3-2
    - install ..... 11-16
    - interface ..... 4-15
    - keypad ..... 4-37
    - labels ..... 4-43
    - language ..... 5-26
    - LEDs ..... 4-38
    - number of characters ..... 4-17
    - password change ..... 4-58
    - plastic protective film ..... 11-21
    - pushbuttons ..... 5-126
    - specifications ..... 2-36
    - switch between enhanced and basic ..... 3-56
    - trouble message ..... 7-9
    - types ..... 4-15
    - use ..... 4-15
    - use in EnerVista ..... 4-17, 6-3
  - Function setting ..... 5-5
  - Fuse failure ..... 5-299
  - Fuse specifications ..... 2-31
  - Fuses not field-replaceable ..... 11-31
- 
- G**
- G.703 ..... 3-41
    - wire size ..... 3-41
  - Gates, logic explained ..... 4-82
  - Gateway address ..... 5-48
  - GE type IAC curves ..... 5-213
  - Generator unbalance
    - FlexLogic operands ..... 5-182
    - logic diagram ..... 5-242
    - settings ..... 5-241
    - specifications ..... 2-22
  - Getting help ..... 1-2
  - GFP Version Mismatch message ..... 7-9

GGIO Ind Oscill message .....	7-9
GOOSE	
actual values .....	6-25
FlexAnalog .....	A-25
routable, explained .....	5-66
settings .....	5-66
simulation operands .....	5-189
simulation settings .....	5-325
Graphical front panel .....	11-16
actual value menu not activated .....	4-52
actual values, phasors .....	4-56
alarm acknowledge, reset .....	4-33, 6-3, 6-4
alarm setup .....	5-36
annunciator editor .....	4-34
date and time .....	5-30
explained .....	4-18
FlexLogic .....	5-180
Home page configuration .....	5-29
interface .....	4-17
IP rating .....	2-37
labels .....	4-48
LEDs .....	4-41, 5-123
Metering Editor .....	4-35
navigation .....	4-50
navigation keys .....	4-37
no display .....	5-31
order codes .....	2-9
phasor diagram .....	4-56, 5-32
plastic protective film .....	11-21
pushbutton testing .....	7-3
pushbuttons .....	5-126
pushbuttons 9 to 16 .....	4-29
settings .....	5-28
settings, breaker .....	5-161
settings, switch .....	5-167
single-line diagrams .....	4-20
specifications .....	2-34, 2-36
time .....	5-30
USB port .....	5-109
use, change setting .....	4-52
view LEDs and pushbuttons in software .....	6-4
Ground current metering .....	6-19
Ground IOC	
FlexLogic operands .....	5-182
logic diagram .....	5-233
settings .....	5-232
specifications .....	2-21
Ground TOC	
FlexLogic operands .....	5-182
logic diagram .....	5-232
settings .....	5-231
specifications .....	2-20
Group 1 switch after powerup .....	5-202
Grouped elements .....	5-202
Guarantee .....	D-1
<hr/>	
<b>H</b>	
HardFiber	
interface module described .....	3-19
order codes for compatible URs .....	2-9
self-test errors .....	7-11
Harmonic content .....	6-22
Harmonics	
actual values .....	6-22
FlexAnalog .....	A-8
specifications .....	2-29
Heartbeat messages .....	5-67, 5-70
Help, getting .....	1-2
Home page configuration .....	5-29
Hottest-spot temperature	
actual values .....	6-17
FlexLogic operands .....	5-186
logic diagram .....	5-208
settings .....	5-208
specifications .....	2-24
HTTP .....	5-100
port, close .....	5-100
Humidity specifications .....	2-37
Hysteresis .....	5-198
<hr/>	
<b>I</b>	
IAC curves .....	5-213
ICD file .....	5-76, 5-77, 5-78
IEC 60870-5-103 protocol	
explained .....	5-104
select protocol .....	5-51
settings .....	5-104
IEC 60870-5-104 protocol	
connections remaining .....	6-11
port, close .....	5-102
select protocol .....	5-51
settings .....	5-101
IEC 61850 protocol	
Edition 1 and 2 support .....	5-57
explained .....	5-57
file transfer .....	5-99
heartbeat messages .....	5-67, 5-70
IID file .....	11-9
settings in EnerVista .....	5-56
specifications .....	2-34
IEC CID files .....	5-59
IED setup .....	3-56
IEEE C37.94 communications .....	3-49, 3-52
IEEE curves .....	5-211
IID file .....	3-72, 5-59, 11-9
import preferences .....	11-9
Import settings file .....	3-72
Import settings from SCD or CID file .....	11-12
In service indicator .....	7-6
In Service LED .....	3-54
Incompatible device order codes or versions .....	11-15

- Inputs
- AC current specifications ..... 2-29
  - AC currents ..... 5-144
  - AC voltage ..... 5-144
  - AC voltage specifications ..... 2-29
  - contact input specifications ..... 2-30
  - contact inputs ..... 5-303, 5-324
  - DCmA input specifications ..... 2-30
  - DCmA inputs ..... 3-32
  - direct input specifications ..... 2-30
  - IRIG-B ..... 3-37
  - IRIG-B specifications ..... 2-30
  - RTD input specifications ..... 2-30
  - RTD inputs ..... 3-32
  - virtual ..... 5-305
- Installation ..... 3-2
- activate relay ..... 3-54
  - add UR devices with auto discovery ..... 3-67
  - communications ..... 3-35
  - CT inputs ..... 3-18
  - front panel ..... 11-16
  - RS485 ..... 3-36
  - set relay to Programmed ..... 3-54
  - settings ..... 5-142
- Instantaneous overcurrent
- see Phase, Ground, and Neutral IOCs
- Interface
- front panel ..... 4-15
  - software ..... 4-1
- Internet access ..... 5-100
- Inter-relay communication specifications ..... 2-35
- Inverse time undervoltage ..... 5-248
- IOC
- see Phase, Ground, and Neutral IOCs
- IP address
- enter in software ..... 5-45
  - enter on front panel ..... 3-58, 4-37
  - gateway ..... 5-48
  - rules ..... 3-58
  - view ..... 5-45
- IP address migration ..... 3-72
- IP rating ..... 2-37
- IP54 for enhanced front panel ..... 3-2
- IRIG-B
- connection on rear panel ..... 3-12
  - explained ..... 3-37
  - port on rear panel ..... 3-12
  - specifications ..... 2-30
- ISO standards ..... 2-39
- 
- J**
- Japanese limited to 10 character input ..... 5-27
- 
- K**
- Keyboard ..... 4-55
- Keypad ..... 4-37
- 
- L**
- Labels, front panel ..... 4-43, 4-75
- Lamp test ..... 7-3
- Language setting ..... 5-26
- Laser module ..... 3-40
- Latching outputs
- application examples ..... 5-308
  - settings ..... 5-307
  - specifications ..... 2-32
- LC fiber ..... 2-9, 3-12
- LC fiber connector ..... 3-13
- LED test
- commands ..... 7-3
  - FlexLogic operand ..... 5-187
  - settings ..... 5-120
  - specifications ..... 2-27
- LEDs
- clear ..... 5-310
  - custom labels ..... 4-43
  - explained ..... 4-38
  - In Service ..... 3-54
  - power supply module ..... 3-17
  - settings ..... 5-123
  - Trouble ..... 3-54
  - view in software for graphical front panel ..... 6-4
- Link power budget ..... 2-35
- Load shedding ..... 5-279, 5-281
- Local access denied message ..... 4-59, 5-21
- Local access, explained ..... 5-8
- Local Setting Authorization ..... 11-15
- Lockout from software ..... 5-14
- Log in with password ..... 3-71, 5-10
- Log in, multiple users cannot ..... 2-6
- Log out
- Administrator manually from front panel ..... 5-21
  - users forcefully ..... 7-3
- Logic diagram
- create ..... 4-61
  - explained ..... 4-60
- Logic gates, FlexLogic ..... 4-82, 5-190
- Logs, system ..... 5-25
- Loss of excitation
- characteristics ..... 5-260
  - FlexLogic operands ..... 5-182
  - logic diagram ..... 5-261
  - settings ..... 5-259
  - specifications ..... 2-25
- Loss of life
- actual values ..... 6-17
  - FlexLogic operands ..... 5-186
  - logic diagram ..... 5-210
  - settings ..... 5-209
- Loss of life transformer specifications ..... 2-24
- Lost password ..... 5-8

Low on Memory message ..... 7-8

## M

MAC address  
 actual values ..... 6-30  
 examples ..... 5-43  
 RxGOOSE ..... 5-73  
 settings for redundancy ..... 5-46  
 TxGOOSE ..... 5-69

Maintenance  
 actual values ..... 6-29  
 alert error message ..... 7-8  
 battery replacement ..... 11-26  
 cleaning ..... 2-39  
 commands ..... 7-3  
 module replacement ..... 11-24  
 upgrade or downgrade ..... 11-14

Manufacturing date ..... 6-30

Maximum 6X, 6X wire size ..... 3-22

Maximum CT/VT wire size ..... 3-18

Measurements of UR and panel cutout ..... 3-2

Media storage alarm message ..... 7-10

Memory low message ..... 7-8

Memory requirements ..... 3-56

Menu navigation ..... 4-49

Message about upgrade over Internet ..... 11-15

Messages  
 clear front panel ..... 5-310  
 error ..... 7-6  
 errors and warnings in Engineer ..... 4-68

Metering  
 conventions ..... 6-13, 6-14  
 editor in graphical front panel ..... 4-35  
 frequency specifications ..... 2-29  
 power specifications ..... 2-28, 2-29  
 THD specifications ..... 2-29  
 voltage specifications ..... 2-28

Microsoft Windows requirement ..... 3-56

Mimic diagrams ..... 4-20

Missing messages, RxGOOSE fail ..... 7-10

MMS connections remaining ..... 6-11

Modbus  
 connections remaining ..... 6-11  
 Flex State parameters ..... 5-132  
 Modbus Analyzer window ..... 11-1  
 port, close ..... 5-51  
 register entry ..... 5-109  
 settings ..... 5-51  
 user map ..... 5-109

Model information, view ..... 6-30

Model number ..... 3-1

Modem connection ..... 3-66

Modification file number ..... 6-31

Module 7R ..... 3-42

Module 7S ..... 3-41

Module Failure message ..... 7-12

## Modules

add and check settings not defaulted ..... 11-25

communications ..... 3-35

CT/VT ..... 3-17, 5-7

order codes ..... 2-15

power supply ..... 3-16

replace ..... 11-24

transducer I/O ..... 3-33

Monitor  
 actual values ..... 11-1  
 actual values with Metering Editor ..... 5-32  
 devices ..... 11-1  
 use alarms ..... 5-36

Monitoring elements settings ..... 5-294

Mounting ..... 3-2

## N

Nameplate, rear ..... 3-1

NAND gate explained ..... 4-82

Navigation keys ..... 4-37

Negative sequence directional overcurrent  
 characteristics ..... 5-239  
 FlexLogic operands ..... 5-182  
 logic diagram ..... 5-240  
 settings ..... 5-237  
 specifications ..... 2-21

Negative sequence overvoltage  
 FlexLogic operands ..... 5-182  
 logic diagram ..... 5-253  
 settings ..... 5-252  
 specifications ..... 2-23

Network settings migration ..... 3-72

Neutral directional overcurrent  
 FlexLogic operands ..... 5-183  
 logic diagram ..... 5-230  
 polarization ..... 5-228  
 settings ..... 5-225  
 specifications ..... 2-21

Neutral IOC  
 FlexLogic operands ..... 5-182  
 logic diagram ..... 5-225  
 settings ..... 5-224  
 specifications ..... 2-21

Neutral overvoltage  
 FlexLogic operands ..... 5-182  
 logic diagram ..... 5-252  
 settings ..... 5-251  
 specifications ..... 2-23

Neutral TOC  
 FlexLogic operands ..... 5-182  
 logic diagram ..... 5-224  
 settings ..... 5-223  
 specifications ..... 2-20

No connection ..... 5-45

Non-volatile data storage ..... 3-17



Non-volatile latches		
FlexLogic operands .....	5-182	
settings .....	5-200	
specifications .....	2-27	
NOR gate explained .....	4-82	
NOT gate explained .....	4-82	
<hr/>		
<b>O</b>		
Obtain list of port numbers .....	5-45	
One-shot		
error compiling in Engineer .....	4-69	
FlexLogic operators .....	5-190	
Operating system		
language .....	3-56	
requirements .....	3-56	
Operating temperature .....	2-37	
Operating times .....	2-20	
Operator command to force logoff .....	7-4	
OR gate explained .....	4-82	
Order codes .....	2-9	
update .....	3-66, 7-3	
view as actual values .....	6-30	
Oscillatory GOOSE maintenance message .....	7-9	
Oscillatory transient testing specifications .....	2-38	
Oscillography		
actual values .....	6-28	
clearing .....	5-41, 7-2	
how to .....	5-116	
settings .....	5-116	
specifications .....	2-28	
via EnerVista software .....	4-2	
view waveform in actual values window .....	6-28	
view waveform in event record .....	6-27	
Out of service .....	5-1	
Outputs		
contact outputs .....	5-306	
control power specifications .....	2-33	
critical failure relay specifications .....	2-32	
Fast form-C relay specifications .....	2-32	
Form-A relay .....	2-31, 3-20	
Form-C relay .....	3-20	
Form-C relay specifications .....	2-32	
latching output specifications .....	2-32	
latching outputs .....	5-307	
virtual outputs .....	5-310	
Over Temperature message .....	7-10	
Overcurrent curves		
FlexCurves .....	5-215	
IAC .....	5-213	
IEC .....	5-212	
types .....	5-210	
Overfrequency		
FlexLogic operands .....	5-183	
logic diagram .....	5-280	
settings .....	5-279	
specifications .....	2-24	
testing .....	9-1	
Overvoltage		
auxiliary .....	2-23, 5-254	
negative sequence .....	5-252	
negative-sequence .....	2-23	
neutral .....	2-23, 5-251	
phase .....	2-23, 5-183, 5-250	
<hr/>		
<b>P</b>		
Panel cutout .....	3-2	
Parallel Redundancy Protocol		
actual values .....	6-12	
explained .....	5-47	
settings .....	5-45	
specifications .....	2-34	
Parity .....	5-42	
Part numbering .....	2-9	
Passwords		
authentication by device or server .....	5-16	
bypass authentication .....	5-23	
change .....	4-58	
change after installation .....	3-71	
change does not take relay out of service .....	5-1	
command .....	4-58, 5-10	
default .....	5-14	
explained .....	2-5	
FlexLogic operands .....	5-188	
lockout .....	4-59, 5-14	
lost password .....	5-8	
requirements .....	5-8	
reset to factory defaults .....	5-8	
rules .....	5-8	
settings .....	4-58, 5-10	
settings templates .....	4-7	
wrong entry .....	4-59	
Percent differential		
calculations .....	5-204	
characteristics .....	5-205	
FlexLogic operands .....	5-186	
logic diagram .....	5-207	
settings .....	5-203	
specifications .....	2-20	
Permissive functions .....	5-248	
Per-unit quantity .....	5-4	
Phase angle metering .....	6-14	
Phase compensation .....	5-155	
Phase current metering .....	6-18	



Phase directional overcurrent	
FlexLogic operands .....	5-183
logic diagram .....	5-222
phase A polarization .....	5-220
settings .....	5-219
specifications .....	2-21
Phase IOC	
FlexLogic operands .....	5-183
logic diagram .....	5-219
settings .....	5-218
specifications .....	2-21
Phase overvoltage	
FlexLogic operands .....	5-183
logic diagram .....	5-251
settings .....	5-250
specifications .....	2-23
Phase rotation .....	5-145
Phase TOC	
FlexLogic operands .....	5-183
logic diagram .....	5-218
settings .....	5-216
specifications .....	2-20
Phase undervoltage	
FlexLogic operands .....	5-183
logic diagram .....	5-250
settings .....	5-249
specifications .....	2-22
Phasor display graphical front panel .....	4-56, 5-32
Ping test times out .....	5-45
Plastic film on front panel .....	11-21
Points List, view DNP .....	5-55
Port	
Ethernet, turn on or off .....	5-45
failure monitoring .....	5-38
HTTP, close .....	5-100
IEC 60870-5-104, close .....	5-102
Modbus, close .....	5-51
on rear panel .....	3-12
TFTP, close .....	5-101
USB .....	4-17
Port number	
combinations with protocols .....	5-51
connectivity report of those used .....	4-76
DNP .....	5-52
HTTP .....	5-100
IEC 60870-5-104 .....	5-101
list of .....	5-45
Modbus .....	5-51
Modbus during installation .....	3-66
RADIUS .....	5-19
SNTP .....	5-113
system log .....	5-19, 5-20
TFTP .....	5-101
Power metering	
specifications .....	2-28
values .....	6-20
Power off, save data first .....	3-17
Power supply	
description .....	3-16
diagram .....	3-12
LED on module .....	3-17
removal to replace battery .....	11-26
RH/RL vs SH/SL .....	11-26
specifications .....	2-31
wire size .....	3-16
Power system settings .....	5-145
Precision Time Protocol	
actual values for port state .....	6-8
clock settings .....	5-110
port behavior .....	5-46
settings .....	5-111
specifications .....	2-34
Preferences	
comparing settings .....	11-7
Engineer .....	4-76
IEC 61850 .....	5-61
import file .....	11-9
Preserve custom attributes importing SCD/CID files .....	11-9
Press Reset Key message .....	7-10
Print front panel labels .....	4-43, 4-75
Process bus	
error messages .....	7-11
order codes for compatible URs .....	2-9
overview .....	3-19
Process Bus Failure message .....	7-12
Process Bus Trouble message .....	7-13
Product information	
actual values .....	6-30
Device Connectivity Report in Engineer .....	4-76
firmware revision .....	6-31
Programmed mode .....	3-54
Protection elements .....	5-4
Protection Summary interface .....	3-69, 4-4, 5-269
Protocol selection .....	5-51
Prototype Firmware message .....	7-9
PRP	
actual values .....	6-12
explained .....	5-47
settings .....	5-45
specifications .....	2-34
PTP	
actual values for port state .....	6-8
clock settings .....	5-110
port behavior .....	5-46
settings .....	5-111
specifications .....	2-34
pu quantity .....	5-4

- Pushbuttons
- control FlexLogic ..... 5-180
  - control logic diagram ..... 5-126
  - control settings ..... 5-125
  - control specifications ..... 2-27
  - testing ..... 7-3
  - user-programmable FlexLogic ..... 5-189
  - user-programmable logic diagrams ..... 5-131
  - user-programmable settings ..... 5-126
  - user-programmable specifications ..... 2-27
  - view in software for graphical front panel ..... 6-4
- 
- Q**
- Quick Connect ..... 3-69, 3-70
- 
- R**
- RADIUS server
- authentication ..... 5-16
  - explained ..... 2-6, 2-8
  - setup ..... B-1
- RAM Filesystem Fail message ..... 7-7
- RAM required ..... 3-56
- Reactive power
- actual values ..... 6-20
  - specifications ..... 2-28
- Real power ..... 6-20
- Real power specifications ..... 2-28
- Real-time clock
- actual values for synchronization ..... 6-8
  - settings ..... 5-110
- Reboot relay
- using EnerVista ..... 5-1
  - using relay ..... 7-3
- Recloser curves ..... 5-173, 5-216
- Redundancy
- power supply ..... 11-26
  - PRP actual values ..... 6-12
  - PRP explained ..... 5-47
  - settings ..... 5-45
  - SNTP ..... 5-113
  - specifications ..... 2-34
- Relay architecture ..... 5-177
- Relay maintenance ..... 7-3
- Relay name ..... 5-142
- Release Notes ..... 11-14
- Remote access of front panel in EnerVista ..... 4-17, 6-3
- Remote access, explained ..... 5-8
- Remote Setting Authorization ..... 11-15
- Repair ..... 1-2, 11-31, D-1
- Replace battery ..... 11-26
- Replace Battery message ..... 7-9
- Replace front panel ..... 11-16
- Replacement modules ..... 2-15, 11-24
- Requirements for installation ..... 3-56
- Reset alarm ..... 6-4
- Reset to factory defaults ..... 5-8, 5-22
- Resetting
- FlexLogic operands ..... 5-188
  - setting to clear LEDs and messages ..... 5-310
  - to factory defaults ..... 5-8, 7-3
- Restart relay
- using EnerVista ..... 5-1
  - using relay ..... 7-3
- Restore settings ..... 11-9
- Restricted ground fault
- actual values ..... 6-26
  - FlexAnalogs ..... A-1
  - FlexLogic operands ..... 5-184
  - logic diagram ..... 5-236
  - settings ..... 5-233
  - specifications ..... 2-20
- Revision history ..... D-1
- RF immunity specifications ..... 2-38
- RFI, conducted specifications ..... 2-38
- R-GOOSE description ..... 5-66
- RH/RL power supply module ..... 11-26
- RJ-45 ..... 2-9, 3-12
- RMS voltage specifications ..... 2-28
- Roles for login ..... 2-6
- Routable GOOSE ..... 5-66
- RRTD Comm Fail message ..... 7-10
- RS232
- baud rate ..... 5-42
  - configuration ..... 3-69
  - specifications ..... 2-34
  - wiring ..... 3-34
- RS422
- configuration ..... 3-45
  - timing ..... 3-46
  - two-channel application ..... 3-45
  - with fiber interface ..... 3-47
- RS485
- description ..... 3-36
  - limitation with CyberSentry ..... 5-17
  - port on rear panel ..... 3-12
  - settings ..... 5-42
  - specifications ..... 2-34
- RTD inputs
- actual values ..... 6-26
  - FlexAnalogs ..... A-1, A-23
  - settings ..... 5-318
  - specifications ..... 2-30
- RTD Trouble message ..... 7-13
- Rules for passwords ..... 5-8
- RxGOOSE
- actual values ..... 6-25
  - FlexAnalogs ..... A-25
  - settings ..... 5-71
- RxGOOSE Fail message ..... 7-10
- RxGOOSE Offline message ..... 7-10

**S**

- Save settings ..... 4-1
- Saving setting does not take relay out of service ..... 5-1
- SCADA protocol selection ..... 5-51
- SCD file
  - import ..... 11-12
  - import preferences ..... 11-9
- SCL compatible ..... 5-57
- SCL file import ..... 5-76, 5-77, 5-78
  - Edition 1 versus 2 ..... 5-57
  - preferences ..... 11-9
- Second Ethernet Fail
  - error message ..... 7-8
  - set alarm ..... 5-38
- Security
  - commands ..... 7-4
  - delete files and records ..... 11-30
  - EnerVista and UR secure with SSH ..... 2-6
  - failed authentication lockout ..... 5-22
  - forceful user logout ..... 7-3
  - lock FlexLogic equations ..... 4-9
  - lock settings ..... 4-5
  - password for settings template ..... 4-7
  - passwords for settings and commands ..... 4-58, 5-10
  - RADIUS server for user authentication ..... B-1
  - role-based user access ..... 2-6
  - settings ..... 5-20
  - software options ..... 2-36
  - specifications ..... 2-36
  - system and event logs ..... 5-25
- Security audit list of port numbers ..... 5-45
- Selector switch
  - actual values ..... 6-8
  - application example ..... 5-276
  - FlexLogic operands ..... 5-184
  - logic diagram ..... 5-278
  - settings ..... 5-272
  - specifications ..... 2-27
  - timing ..... 5-275
- Self-tests
  - description ..... 7-6
  - error messages ..... 7-6
  - FlexLogic operands ..... 5-189
  - user-programmable ..... 5-124
- Sensitive directional power
  - actual values ..... 6-25
  - characteristic ..... 5-264
  - FlexAnalog ..... A-1
  - FlexLogic operands ..... 5-181
  - logic diagram ..... 5-266
  - settings ..... 5-263
  - specifications ..... 2-22
- Serial number ..... 3-1, 4-11, 6-30
- Serial ports
  - device setup with ..... 3-64
  - location ..... 4-15
  - settings ..... 5-42
  - specifications ..... 2-34
  - wiring ..... 3-47
- Server authentication ..... 5-16
- Service life expected ..... 11-3
- Service Report ..... 1-2
- Setting Changed message ..... 7-9
- Setting groups ..... 5-202, 5-270
  - active setting group ..... 5-202
  - FlexLogic operands ..... 5-184
  - troubleshooting ..... 5-202
- Settings ..... 5-1
  - back up ..... 5-59, 11-9
  - change ..... 4-51
  - change does not take relay out of service ..... 5-1
  - compare ..... 11-7
  - control user accounts ..... 5-14
  - convert ..... 11-5
  - default to factory defaults ..... 7-3
  - edit ..... 4-51
  - export ..... 11-9
  - import ..... 3-72
  - lock ..... 4-5
  - not updated automatically among computers ..... 3-68
  - read from device with Modbus Analyzer ..... 11-1
  - restore ..... 11-9
  - upgrade ..... 11-5
  - write to device with Modbus Analyzer ..... 11-1
- Settings file ..... 5-59
  - description ..... 4-1
  - import ..... 3-72
  - takes relay out of service when loaded ..... 4-2
  - traceability ..... 4-12
  - transfer with USB stick ..... 4-17
- Settings password ..... 4-58, 5-10
- Settings Save Error message ..... 7-10
- Settings templates
  - description ..... 4-5
  - edit ..... 4-6
  - enable ..... 4-5
  - password protection ..... 4-7
  - remove ..... 4-9
  - view ..... 4-7
- SFP
  - explained ..... 3-11
  - module fail message ..... 7-9
  - photo ..... 11-22
- SH/SL power supply module ..... 11-26
- Signal loss detection for fiber ..... 5-46
- Signal sources
  - description ..... 5-6
  - metering ..... 6-18
  - settings ..... 5-146

Simulation		
operands	5-189	
settings	5-325	
Simulation bit	5-323	
Single-line diagram		
create, explained	4-20	
save as separate file	4-24	
Single-line diagrams	2-2	
Site Targets	11-1	
Size of UR and panel cutout	3-2	
Smart defaults	5-116	
SNTP Failure message	7-9	
SNTP protocol		
accuracy specifications	2-34	
redundant source	5-113	
settings	5-113	
Software		
installation	3-56	
interface explained	4-1	
language	5-27	
system requirements	3-56	
update or downgrade	11-13	
Source frequency	6-22	
Source transfer schemes	5-248	
Sources		
description	5-6	
example of use	5-148	
FlexAnalogs	A-2	
metering	6-18	
settings	5-146	
Special characters	4-55	
Specifications	2-20	
Split phase protection		
FlexLogic operands	5-184	
logic diagram	5-247	
settings	5-243	
specifications	2-22	
ST fiber	2-9, 3-12	
ST fiber connector	3-13	
Standards, certification	2-39	
Stator ground		
FlexAnalogs	A-1	
Stator ground fault		
actual values	6-25	
Status LEDs	4-40, 4-41	
Stop blinking alarm	4-33	
Storage Media Alarm message	7-10	
Storage temperature	2-37	
Storage, UR	11-31	
Substation D400	3-73	
Support, technical	1-2	
Surge immunity specifications	2-38	
Switch		
actual values	6-8	
control with IEC 61850	5-92	
IEC 61850 Edition 1 and 2	5-57	
settings	5-165, 5-272	
Synchrocheck		
actual values	6-23	
FlexAnalogs	A-21	
FlexLogic operands	5-185	
logic diagram	5-288	
settings	5-283	
specifications	2-25	
Synchronize		
clock using time source	5-110	
clocks of UR devices to local computer	5-111	
files between offline and online	4-68	
Synchronize Devices setting for clocks	5-111	
Syslog	5-25	
System and device information	4-76	
System Exception message	7-10	
System Failure message	7-7	
System frequency	5-145	
System logs	5-25	
System requirements	3-56	
System setup	5-144	
<hr/>		
<b>T</b>		
Targets		
defined	4-19	
menu	7-5	
messages	7-5	
overview by device	11-1	
settings	5-5	
TBD	11-9	
TCP port number for web access	5-100	
TDR Trouble message	7-13	
Technical support	1-2	
files	1-2, 11-3	
Teleprotection		
actual values	6-6	
clearing counters	7-2	
FlexLogic operands	5-185	
logic diagram	5-316	
overview	5-315	
settings	5-141, 5-315, 5-316	
specifications	2-31	
Temp Monitor message	7-10	
Temperature		
FlexLogic monitor operand	5-189	
operating and storage	2-37	
transformer hot-spot settings	5-208	
Test voltages	3-15	
Testing		
force contact inputs	5-324	
force contact outputs	5-324	
lamp test	7-3	
LEDs	7-3	
over/underfrequency	9-1	
pushbuttons	7-3	
self-test error messages	7-6	
settings	5-323	

TFTP	
port, close .....	5-101
put cannot be done .....	5-101
settings .....	5-101
THD .....	A-15
THD metering .....	6-22
analog channel correspondence .....	5-118
THD metering specifications .....	2-29
The URS file is part of a device folder .....	11-12
Thermal inputs	
actual values .....	6-17
settings .....	5-159
Thermal overload protection	
logic diagram .....	5-303
settings .....	5-300
specifications .....	2-26
Third Ethernet Fail	
error message .....	7-8
set alarm .....	5-38
Third harmonic neutral undervoltage	
FlexLogic operands .....	5-180
logic diagram .....	5-268
settings .....	5-267
specifications .....	2-23
Tilda on front panel .....	4-17
Time	
actual values .....	6-8, 6-29
FlexLogic timer settings .....	5-196
graphical front panel format .....	5-30
operating .....	6-30
overwritten by external source .....	7-3
set .....	5-29, 5-110, 7-3
Time overcurrent	
see Phase, Neutral, and Ground TOCs	
Timeout, connection .....	5-51
To Install Settings message .....	7-7
TOC	
ground .....	5-231
neutral .....	5-223
phase .....	5-216
specifications .....	2-20
Toolbar .....	4-80
Torque for screws .....	2-39, 3-12, 3-22
Total harmonic distortion .....	A-15
Traceability	
data .....	4-13
overview .....	4-12
rules .....	4-14
view data .....	4-14
Tracking frequency .....	6-23
Transducer I/O	
actual values .....	6-26
settings .....	5-317
specifications .....	2-30
wiring .....	3-33
Transfer files to relay .....	11-7
Transfer files with USB drive .....	4-17
Transformer	
actual values .....	6-17
aging factor .....	2-24, 5-208
FlexAnalog .....	A-14
hottest-spot temperature .....	2-24, 5-208
loss of life .....	2-24, 5-209
metering .....	6-17
phase relationships .....	5-152
settings .....	5-149
thermal inputs .....	5-159
Transformer differential .....	5-151, 5-159
Triangle in Offline Window .....	4-68
Trip bus	
FlexLogic operands .....	5-185
logic diagram .....	5-270
settings .....	5-268
Trip LEDs .....	5-123
Trouble indicator .....	7-6
Trouble LED .....	3-54
Troubleshooting	
access to device .....	3-68
breaker not working .....	5-289
connection .....	5-45
dark graphical front panel .....	5-31
Engineer .....	4-69, 4-70
error messages .....	7-6
setting not working .....	5-289
unit not programmed error .....	5-142
Turn off alarm .....	4-33
TxGOOSE	
actual values .....	6-12, 6-13
settings .....	5-67
<hr/>	
<b>U</b>	
UDP for TFTP .....	5-101
UL certification .....	2-39
Unable to connect to relay .....	3-68, 5-45
Unable to put relay in flash mode .....	11-15
Unauthorized access	
commands .....	5-41
resetting .....	7-2
Underfrequency	
FlexLogic operands .....	5-186
logic diagram .....	5-279
settings .....	5-278
specifications .....	2-24
testing .....	9-1
Undervoltage	
auxiliary .....	2-22
characteristics .....	5-248
phase .....	2-22, 5-249
settings .....	5-249
third harmonic neutral .....	5-267
Undervoltage third harmonic neutral .....	2-23
Uninstall .....	11-30
Unit Not Calibrated message .....	7-10

Unit not programmed .....	5-142, 7-7
Unpacking the relay .....	3-1
Unreturned messages alarm .....	5-141
Update SCL files prompt .....	4-68
Update settings with Convert Device Settings .....	11-5
Updates	
device not recognized .....	11-14
firmware .....	11-14
FPGA .....	11-16
instruction manual .....	3-1
order code .....	7-3
single-line diagrams not retained .....	4-24
software .....	11-13
Upgrade device settings .....	11-5
Upgrade over Internet message .....	11-15
Upload settings to relay .....	11-7
URS file does not include IEC 61850 configuration .....	11-12
URS file is part of a device folder .....	11-12
URS settings file .....	3-72, 5-59, 11-9
USB port	
graphical front panel .....	4-17, 5-109
Quick Connect .....	3-70
specifications .....	2-34
User accounts	
add .....	5-14
authentication by device or server .....	5-16
multiple login limitation CyberSentry .....	2-6
passwords for settings and commands .....	4-58, 5-10
permissions by role .....	2-6
permissions, set .....	5-14
User-definable displays	
example .....	5-134
invoking and scrolling .....	5-133
settings .....	5-133
specifications .....	2-27
User-programmable fault report	
actual values .....	6-26
clearing .....	5-40, 7-2
settings .....	5-115
User-programmable LEDs	
custom labels .....	4-43
defaults .....	4-41
settings .....	5-123
specifications .....	2-27
User-programmable pushbuttons	
FlexLogic operands .....	5-189
graphical front panel buttons 9 to 16 .....	4-29
logic diagrams .....	5-131
settings .....	5-126
specifications .....	2-27
testing .....	7-3
User-programmable self-test settings .....	5-124

---

**V**

VAR hour	
actual values .....	6-21
specifications .....	2-29
Vibration testing specifications .....	2-38
Virtual inputs	
actual values .....	6-5
commands .....	7-2
explained .....	5-306
FlexLogic operands .....	5-187
logic diagram .....	5-306
settings .....	5-305
Virtual outputs	
actual values .....	6-6
explained .....	5-310
FlexLogic operands .....	5-187
settings .....	5-310
Voltage banks .....	5-144
Voltage deviation specifications .....	2-38
Voltage elements .....	5-248
Voltage metering	
actual values .....	6-19
specifications .....	2-28
Voltage Monitor message .....	7-11
Voltage restraint characteristic .....	5-216
Volts per hertz	
actual values .....	6-26
curves .....	5-256
FlexAnalogs .....	A-25
FlexLogic operands .....	5-186
logic diagram .....	5-256
settings .....	5-255
specifications .....	2-24
VT fuse failure	
FlexAnalogs .....	A-25
FlexLogic operands .....	5-184
logic diagram .....	5-300
settings .....	5-299
VT inputs .....	3-17, 3-18, 5-7, 5-144
VT wiring .....	3-18
VTFF .....	5-299, A-25

---

**W**

Warning messages in Engineer .....	4-70
Warning symbol in Offline Window .....	4-68
Warning, firmware upload not supported .....	11-15
Warranty .....	D-1
Watt-hour	
actual values .....	6-21
specifications .....	2-29
Waveform	
view in actual values window .....	6-28
view in event record .....	6-27
Waveform files, view .....	4-79
Web access port .....	5-100

## INDEX

Web server protocol .....	5-100
Winding	
settings .....	5-151
Windows requirement .....	3-56
Wire size	
CT/VT .....	3-18
F485 converter .....	3-55
G.703 and fiber interface .....	3-48
G.703 interface .....	3-41
module 7S .....	3-41
modules 6X, 6W .....	3-22
modules 7E, 7F, 7G, 7Q, 7S .....	3-48
modules 7L, 7M, 7N, 7P, 74 .....	3-47
modules 7T, 7W .....	3-45
power supply module .....	3-16
RS422 and fiber interface .....	3-47
RS422 interface .....	3-45
Wiring diagrams .....	3-13
Withdraw UR from operation .....	11-30
Wrong Transceiver message .....	7-11

---

## X

XOR gate explained .....	4-82
--------------------------	------

---

## Y

Yellow caution icon in Offline Window .....	4-68
---	------

---

## Z

Zero-sequence compensation .....	5-155
Zero-sequence core balance .....	3-18

